



# City of Chicago



O2013-6101

Office of the City Clerk

## Document Tracking Sheet

**Meeting Date:** 9/11/2013

**Sponsor(s):** City Clerk (transmitted by) (Clerk)

**Type:** Ordinance

**Title:** Zoning Reclassification App No. 17829 at 3670-3688 N  
Milwaukee Ave and 3700-3738 N Milwaukee Ave

**Committee(s) Assignment:** Committee on Zoning, Landmarks and Building Standards

BE IT ORDAINED BY THE CITY COUNCIL OF THE CITY OF CHICAGO:

SECTION 1. That the Chicago Zoning Ordinance be amended by changing all the Residential Planned Development #1046 symbols and indications as shown on Map Number 9-K in the area bounded by:

Starting at a point 851.48 feet north of the north line of West Addison Street on the east line of the Chicago, St. Paul and Pacific Railroad right-of-way; a line extending 81.12 feet northeast and perpendicular to North Milwaukee Avenue; the west line of North Milwaukee Avenue southeast for a distance of 394.00 feet; a line perpendicular to North Milwaukee Avenue traveling southwest for a distance of 125.00 feet; a line parallel to North Milwaukee Avenue traveling southeast for a distance of 105.00 feet; a line perpendicular to North Milwaukee Avenue traveling northeast a distance of 125.00 feet to North Milwaukee Avenue; the west line of North Milwaukee Avenue southeast for a distance of 215.00 feet; a line perpendicular to North Milwaukee Avenue traveling southwest for 125.00 feet; a line parallel to North Milwaukee Avenue traveling southeast 3.00 feet; a line perpendicular to North Milwaukee Avenue traveling southwest for 168.51 feet; a line traveling southwesterly 46.30 feet intersecting the arc hereinafter described; a 190.86 foot arc traveling northwest to a point of intersection with a line beginning 202.28 feet north of the north line of West Addison Street, running perpendicular to North Milwaukee Avenue and southwest for 33.58 feet to its intersection with a point 202.28 feet north of the north line of West Addison Street, said point being along the Chicago, St. Paul and Pacific Railroad right-of-way; and the Chicago, St. Paul and Pacific Railroad right-of-way line for a distance of 649.2 feet to the point of beginning,

to those of Residential Planned Development #1046, as Amended, and a corresponding use district is hereby established in the area above described.

SECTION 2. This ordinance shall be in force and effect from and after its passage and due publication.

Common Address for the Property: 3670-3688 and 3700-3738 North Milwaukee,  
Chicago, Illinois

CITY OF CHICAGO

APPLICATION FOR AN AMENDMENT TO  
THE CHICAGO ZONING ORDINANCE

# 17829  
INT NO DATE:  
SEPT. 11, 2013

1. ADDRESS of the property Applicant is seeking to rezone:

3670-3688 and 3700-3738 North Milwaukee

2. Ward Number that property is located in: 45<sup>th</sup>

3. APPLICANT Nahshon Development, LLC

ADDRESS 401 South LaSalle Street, 403

CITY Chicago STATE Illinois ZIP CODE 60605

PHONE 773/ 427-2450 CONTACT PERSON Naganathan Guru

4. Is the applicant the owner of the property? YES \_\_\_\_\_ NO X

If the applicant is not the owner of the property, please provide the following information regarding the owner and attach written authorization from the owner allowing the application to proceed.

OWNER 3670-3720 North Milwaukee, LLC

ADDRESS 4252 North Cicero Avenue

CITY Chicago STATE Illinois ZIP CODE 60641

PHONE 773/ 427-2450 CONTACT PERSON Naganathan Guru

5. If the Applicant/Owner of the property has obtained a lawyer as their representative for the rezoning, please provide the following information:

ATTORNEY Bernard I. Citron/Jessica M. Schramm

ADDRESS Thompson Coburn LLP, 55 E. Monroe, 37<sup>th</sup> Floor CITY Chicago, IL 60603

PHONE (312) 346-7500 FAX (312) 580-2201

6. If the applicant is a corporation please provide the names of all shareholders as disclosed on the Economic Disclosure Statements.

N/A  
\_\_\_\_\_  
\_\_\_\_\_  
\_\_\_\_\_  
\_\_\_\_\_  
\_\_\_\_\_

7. On what date did the owner acquire legal title to the subject property? 2006-07

8. Has the present owner previously rezoned this property? If yes, when?

A Planned Development was approved on January 11, 2007.  
\_\_\_\_\_

9. Present Zoning District RPD #1046 Proposed Zoning District RPD #1046, As Amended

10. Lot size in square feet (or dimensions) 179,588 square feet

11. Current Use of the property Vacant, one-story commercial buildings and surface parking lots.

12. Reason for rezoning the property To Amend the Plan of Development

13. Describe the proposed use of the property after the rezoning. Indicate the number of dwelling units; number of parking spaces; approximate square footage of any commercial space; and height of the proposed building. (BE SPECIFIC)

The Applicant is proposing to construct 50 single family homes with a minimum of 100 parking spaces and a maximum of 140 parking spaces in private garages.  
\_\_\_\_\_

14. On May 10, 2007, the Chicago City Council passed the Affordable Requirements Ordinance (ARO) that requires on-site affordable housing units or a financial contribution if residential housing projects receive a zoning change under certain circumstances. Based on the lot size of the project in question and the proposed zoning classification, is this project subject to the Affordable Requirements Ordinance? (See Fact Sheet for more information)

YES \_\_\_\_\_ NO X

COUNTY OF COOK  
STATE OF ILLINOIS

I, Naganathan Guru, being first duly sworn on oath, states that all of the above statements and the statements contained in the documents submitted herewith are true and correct.

*Naganathan Guru*  
Signature of Applicant

Subscribed and Sworn to before me this  
26th day of August, 2013.

*Diane Lemon*  
Notary Public

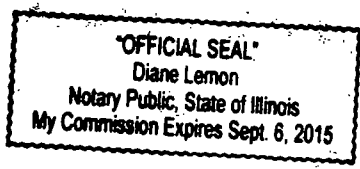

**For Office Use Only**

Date of Introduction: \_\_\_\_\_

File Number: \_\_\_\_\_

Ward: \_\_\_\_\_

OFFICIAL SEAL  
State of Illinois  
Notary Public  
My Commission Expires Sept. 8, 2012

"WRITTEN NOTICE"  
AFFIDAVIT  
(Section 17-13-0107)

September 11, 2013

Honorable Daniel S. Solis  
Chairman, Committee on Zoning  
121 North LaSalle Street  
Room 304, City Hall  
Chicago, Illinois 60602

The undersigned, Jessica Schramm, being first duly sworn on oath deposes and states the following:

The undersigned certifies that he has complied with the requirements of Section 17-13-0107 of the Chicago Zoning Ordinance, by sending written notice to such property owners who appear to be the owners of the property within the subject area not solely owned by the applicant, and to the owners of all property within 250 feet in each direction of the lot line of the subject property, exclusive of public roads, streets, alleys and other public ways, or a total distance limited to 400 feet. Said "written notice" was sent by First Class U.S. Mail, no more than 30 days before filing the application.

The undersigned certifies that the notice contained the address of the property sought to be rezoned; a statement of the intended use of the property; the name and address of the applicant; the name and address of the owner; and a statement that the applicant intends to file the application for a change in zoning on approximately September 11, 2013.

The undersigned certifies that the applicant has made a bona fide effort to determine the addresses of the parties to be notified under Section 17-13-0107 of the Chicago Zoning Ordinance, and that the accompanying list of names and addresses of surrounding property owners within 250 feet of the subject site is a complete list containing the names and addresses of the people required to be served.

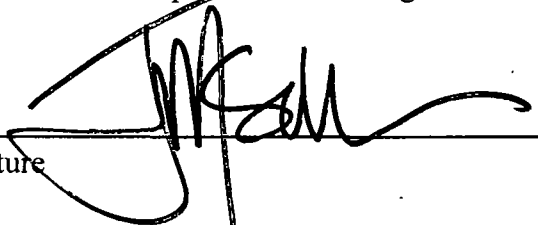
  
\_\_\_\_\_  
Signature

Subscribed and Sworn to before me this  
day of September, 2013.

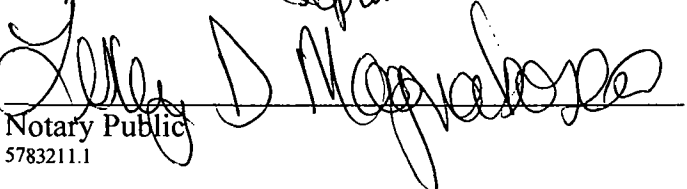
  
\_\_\_\_\_  
Notary Public  
5783211.1

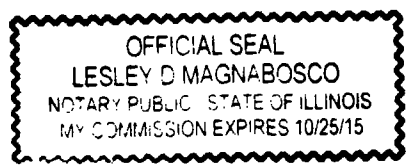

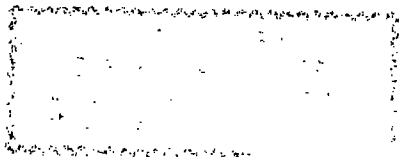



September 11, 2013

Dear Property Owner:

In accordance with the requirements for an Amendment to the Chicago Zoning Ordinance, specifically Section 17-13-0107, please be informed that on or about September 11, 2013 the undersigned will file an application for a change in zoning from Residential Planned Development No. 1046 to Residential Planned Development No. 1046, As Amended on behalf of Nahshon Development, LLC for the property located at 3670-3688 and 3700-3738 North Milwaukee, Chicago, Illinois.

The Applicant is proposing to construct 50 single family homes with a minimum of 100 parking spaces and a maximum of 140 parking spaces in private garages.

The Applicant for this Amendment is Nahshon Development, LLC located at 401 South LaSalle Street, 403, Chicago, Illinois 60605. The Owner is 3670-3720 North Milwaukee, LLC located at 4252 North Cicero Avenue, Chicago, Illinois 60641. The contact person for this application is Jessica Schramm of Thompson Coburn, LLP, 55 East Monroe Street, 37th Floor, Chicago, Illinois 60603, (312) 580-2249.

PLEASE NOTE THAT THE APPLICANT IS NOT SEEKING TO REZONE OR PURCHASE YOUR PROPERTY. THE APPLICANT IS REQUIRED BY LAW TO SEND THIS NOTICE BECAUSE YOU OWN PROPERTY WITHIN 250 FEET OF THE PROPERTY TO BE REZONED.

Very truly yours,

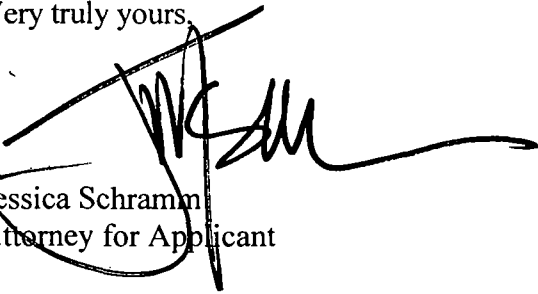

Jessica Schramm  
Attorney for Applicant

**CITY OF CHICAGO  
ECONOMIC DISCLOSURE STATEMENT  
AND AFFIDAVIT**

**SECTION I -- GENERAL INFORMATION**

A. Legal name of the Disclosing Party submitting this EDS. Include d/b/a/ if applicable:

Nahshon Development, L.L.C.

**Check ONE of the following three boxes:**

Indicate whether the Disclosing Party submitting this EDS is:

1.  the Applicant

OR

2.  a legal entity holding a direct or indirect interest in the Applicant. State the legal name of the Applicant in which the Disclosing Party holds an interest: \_\_\_\_\_ OR

3.  a legal entity with a right of control (see Section II.B.1.) State the legal name of the entity in which the Disclosing Party holds a right of control: \_\_\_\_\_

B. Business address of the Disclosing Party: 4252 N CICERO AVE

CHICAGO, IL 60641

C. Telephone: 773-427-2400 Fax: \_\_\_\_\_ Email: gurun@dubinresidential.com Name of contact

person: Naganat Guru

E. Federal Employer Identification No. (if you have one): \_\_\_\_\_

F. Brief description of contract, transaction or other undertaking (referred to below as the "Matter") to which this EDS pertains. (Include project number and location of property, if applicable):

Planned Development Amendment for the property located at 3670-3688 & 3700-3738 North

Milwaukee.

G. Which City agency or department is requesting this EDS? Dept. of Housing and Economic Development

If the Matter is a contract being handled by the City's Department of Procurement Services, please complete the following:

Specification # \_\_\_\_\_ and Contract # \_\_\_\_\_

**SECTION II -- DISCLOSURE OF OWNERSHIP INTERESTS**

**A. NATURE OF THE DISCLOSING PARTY**

1. Indicate the nature of the Disclosing Party:

- Person
- Publicly registered business corporation
- Privately held business corporation
- Sole proprietorship
- General partnership
- Limited partnership
- Trust
- Limited liability company
- Limited liability partnership
- Joint venture
- Not-for-profit corporation  
(Is the not-for-profit corporation also a 501(c)(3))?  
 Yes  No
- Other (please specify)

2. For legal entities, the state (or foreign country) of incorporation or organization, if applicable:

ILLINOIS

3. For legal entities not organized in the State of Illinois: Has the organization registered to do business in the State of Illinois as a foreign entity?

- Yes  No  N/A

**B. IF THE DISCLOSING PARTY IS A LEGAL ENTITY:**

1. List below the full names and titles of all executive officers and all directors of the entity.

**NOTE:** For not-for-profit corporations, also list below all members, if any, which are legal entities. If there are no such members, write "no members." For trusts, estates or other similar entities, list below the legal titleholder(s).

If the entity is a general partnership, limited partnership, limited liability company, limited liability partnership or joint venture, list below the name and title of each general partner, managing member, manager or any other person or entity that controls the day-to-day management of the Disclosing Party.

**NOTE:** Each legal entity listed below must submit an EDS on its own behalf.

Name	Title
WKN. Inc.	Managing Member

2. Please provide the following information concerning each person or entity having a direct or indirect beneficial interest (including ownership) in excess of 7.5% of the Disclosing Party. Examples of such an interest include shares in a corporation, partnership interest in a partnership or joint venture,

interest of a member or manager in a limited liability company, or interest of a beneficiary of a trust, estate or other similar entity. If none, state "None." NOTE: Pursuant to Section 2-154-030 of the Municipal Code of Chicago ("Municipal Code"), the City may require any such additional information from any applicant which is reasonably intended to achieve full disclosure.

Name	Business Address	Percentage Interest in the Disclosing Party
WKN Inc.	4252 N. Cicero Ave, Chicago IL	100%

---

---

**SECTION III -- BUSINESS RELATIONSHIPS WITH CITY ELECTED OFFICIALS**

Has the Disclosing Party had a "business relationship," as defined in Chapter 2-156 of the Municipal Code, with any City elected official in the 12 months before the date this EDS is signed?

Yes                       No

If yes, please identify below the name(s) of such City elected official(s) and describe such relationship(s):

---

---

**SECTION IV -- DISCLOSURE OF SUBCONTRACTORS AND OTHER RETAINED PARTIES**

The Disclosing Party must disclose the name and business address of each subcontractor, attorney, lobbyist, accountant, consultant and any other person or entity whom the Disclosing Party has retained or expects to retain in connection with the Matter, as well as the nature of the relationship, and the total amount of the fees paid or estimated to be paid. The Disclosing Party is not required to disclose employees who are paid solely through the Disclosing Party's regular payroll.

“Lobbyist” means any person or entity who undertakes to influence any legislative or administrative action on behalf of any person or entity other than: (1) a not-for-profit entity, on an unpaid basis, or (2) himself. “Lobbyist” also means any person or entity any part of whose duties as an employee of another includes undertaking to influence any legislative or administrative action.

If the Disclosing Party is uncertain whether a disclosure is required under this Section, the Disclosing Party must either ask the City whether disclosure is required or make the disclosure.

Name (indicate whether retained or anticipated to be retained)	Business Address	Relationship to Disclosing Party (subcontractor, attorney, lobbyist, etc.)	Fees (indicate whether paid or estimated.) <b>NOTE:</b> "hourly rate" or "t.b.d." is not an acceptable response.
--	------------------	--	--

---

PER EXHIBIT A

---

(Add sheets if necessary)

Check here if the Disclosing Party has not retained, nor expects to retain, any such persons or entities.

**SECTION V -- CERTIFICATIONS**

**A. COURT-ORDERED CHILD SUPPORT COMPLIANCE**

Under Municipal Code Section 2-92-415, substantial owners of business entities that contract with the City must remain in compliance with their child support obligations throughout the contract's term.

Has any person who directly or indirectly owns 10% or more of the Disclosing Party been declared in arrearage on any child support obligations by any Illinois court of competent jurisdiction?

Yes             No             No person directly or indirectly owns 10% or more of the Disclosing Party.

If "Yes," has the person entered into a court-approved agreement for payment of all support owed and is the person in compliance with that agreement?

Yes             No

**B. FURTHER CERTIFICATIONS**

1. Pursuant to Municipal Code Chapter 1-23, Article I ("Article I")(which the Applicant should consult for defined terms (e.g., "doing business") and legal requirements), if the Disclosing Party submitting this EDS is the Applicant and is doing business with the City, then the Disclosing Party certifies as follows: (i) neither the Applicant nor any controlling person is currently indicted or charged with, or has admitted guilt of, or has ever been convicted of, or placed under supervision for, any criminal offense involving actual, attempted, or conspiracy to commit bribery, theft, fraud, forgery, perjury, dishonesty or deceit against an officer or employee of the City or any sister agency; and (ii) the Applicant understands and acknowledges that compliance with Article I is a continuing requirement for doing business with the City. **NOTE:** If Article I applies to the Applicant, the permanent compliance timeframe in Article I supersedes some five-year compliance timeframes in certifications 2 and 3 below.

2. The Disclosing Party and, if the Disclosing Party is a legal entity, all of those persons or entities identified in Section II.B.1. of this EDS:

- a. are not presently debarred, suspended, proposed for debarment, declared ineligible or voluntarily excluded from any transactions by any federal, state or local unit of government;
- b. have not, within a five-year period preceding the date of this EDS, been convicted of a criminal offense, adjudged guilty, or had a civil judgment rendered against them in connection with: obtaining, attempting to obtain, or performing a public (federal, state or local) transaction or contract under a public transaction; a violation of federal or state antitrust statutes; fraud; embezzlement; theft; forgery; bribery; falsification or destruction of records; making false statements; or receiving stolen property;
- c. are not presently indicted for, or criminally or civilly charged by, a governmental entity (federal, state or local) with committing any of the offenses set forth in clause B.2.b. of this Section V;
- d. have not, within a five-year period preceding the date of this EDS, had one or more public transactions (federal, state or local) terminated for cause or default; and
- e. have not, within a five-year period preceding the date of this EDS, been convicted, adjudged guilty, or found liable in a civil proceeding, or in any criminal or civil action, including actions concerning environmental violations, instituted by the City or by the federal government, any state, or any other unit of local government.

3. The certifications in subparts 3, 4 and 5 concern:

- the Disclosing Party;
- any "Contractor" (meaning any contractor or subcontractor used by the Disclosing Party in connection with the Matter, including but not limited to all persons or legal entities disclosed under Section IV, "Disclosure of Subcontractors and Other Retained Parties");
- any "Affiliated Entity" (meaning a person or entity that, directly or indirectly: controls the Disclosing Party, is controlled by the Disclosing Party, or is, with the Disclosing Party, under common control of another person or entity. Indicia of control include, without limitation: interlocking management or ownership; identity of interests among family members, shared facilities and equipment; common use of employees; or organization of a business entity following the ineligibility of a business entity to do business with federal or state or local government, including the City, using substantially the same management, ownership, or principals as the ineligible entity); with respect to Contractors, the term Affiliated Entity means a person or entity that directly or indirectly controls the Contractor, is controlled by it, or, with the Contractor, is under common control of another person or entity;
- any responsible official of the Disclosing Party, any Contractor or any Affiliated Entity or any other official, agent or employee of the Disclosing Party, any Contractor or any Affiliated Entity, acting pursuant to the direction or authorization of a responsible official of the Disclosing Party, any Contractor or any Affiliated Entity (collectively "Agents").

Neither the Disclosing Party, nor any Contractor, nor any Affiliated Entity of either the Disclosing Party or any Contractor nor any Agents have, during the five years before the date this EDS is signed, or, with respect to a Contractor, an Affiliated Entity, or an Affiliated Entity of a Contractor during the five years before the date of such Contractor's or Affiliated Entity's contract or engagement in connection with the Matter:

- a. bribed or attempted to bribe, or been convicted or adjudged guilty of bribery or attempting to bribe, a public officer or employee of the City, the State of Illinois, or any agency of the federal government or of any state or local government in the United States of America, in that officer's or employee's official capacity;
- b. agreed or colluded with other bidders or prospective bidders, or been a party to any such agreement, or been convicted or adjudged guilty of agreement or collusion among bidders or prospective bidders, in restraint of freedom of competition by agreement to bid a fixed price or otherwise; or
- c. made an admission of such conduct described in a. or b. above that is a matter of record, but have not been prosecuted for such conduct; or
- d. violated the provisions of Municipal Code Section 2-92-610 (Living Wage Ordinance).

4. Neither the Disclosing Party, Affiliated Entity or Contractor, or any of their employees, officials, agents or partners, is barred from contracting with any unit of state or local government as a result of engaging in or being convicted of (1) bid-rigging in violation of 720 ILCS 5/33E-3; (2) bid-rotating in violation of 720 ILCS 5/33E-4; or (3) any similar offense of any state or of the United States of America that contains the same elements as the offense of bid-rigging or bid-rotating.

5. Neither the Disclosing Party nor any Affiliated Entity is listed on any of the following lists maintained by the Office of Foreign Assets Control of the U.S. Department of the Treasury or the Bureau of Industry and Security of the U.S. Department of Commerce or their successors: the Specially Designated Nationals List, the Denied Persons List, the Unverified List, the Entity List and the Debarred List.

6. The Disclosing Party understands and shall comply with the applicable requirements of Chapters 2-55 (Legislative Inspector General), 2-56 (Inspector General) and 2-156 (Governmental Ethics) of the Municipal Code.

7. If the Disclosing Party is unable to certify to any of the above statements in this Part B (Further Certifications), the Disclosing Party must explain below:

---

N/A

---

---

---

If the letters "NA," the word "None," or no response appears on the lines above, it will be conclusively presumed that the Disclosing Party certified to the above statements.

8. To the best of the Disclosing Party's knowledge after reasonable inquiry, the following is a complete list of all current employees of the Disclosing Party who were, at any time during the 12-month period preceding the execution date of this EDS, an employee, or elected or appointed official, of the City of Chicago (if none, indicate with "N/A" or "none").

---

---

---

9. To the best of the Disclosing Party's knowledge after reasonable inquiry, the following is a complete list of all gifts that the Disclosing Party has given or caused to be given, at any time during the 12-month period preceding the execution date of this EDS, to an employee, or elected or appointed official, of the City of Chicago. For purposes of this statement, a "gift" does not include: (i) anything made generally available to City employees or to the general public, or (ii) food or drink provided in the course of official City business and having a retail value of less than \$20 per recipient (if none, indicate with "N/A" or "none"). As to any gift listed below, please also list the name of the City recipient.

---

---

---

### C. CERTIFICATION OF STATUS AS FINANCIAL INSTITUTION

1. The Disclosing Party certifies that the Disclosing Party (check one)

is                       is not

a "financial institution" as defined in Section 2-32-455(b) of the Municipal Code.

2. If the Disclosing Party IS a financial institution, then the Disclosing Party pledges:

"We are not and will not become a predatory lender as defined in Chapter 2-32 of the Municipal Code. We further pledge that none of our affiliates is, and none of them will become, a predatory lender as defined in Chapter 2-32 of the Municipal Code. We understand that becoming a predatory lender or becoming an affiliate of a predatory lender may result in the loss of the privilege of doing business with the City."

If the Disclosing Party is unable to make this pledge because it or any of its affiliates (as defined in Section 2-32-455(b) of the Municipal Code) is a predatory lender within the meaning of Chapter 2-32 of the Municipal Code, explain here (attach additional pages if necessary):

---

---



---

If the letters "NA," the word "None," or no response appears on the lines above, it will be conclusively presumed that the Disclosing Party certified to the above statements.

**D. CERTIFICATION REGARDING INTEREST IN CITY BUSINESS**

Any words or terms that are defined in Chapter 2-156 of the Municipal Code have the same meanings when used in this Part D.

1. In accordance with Section 2-156-110 of the Municipal Code: Does any official or employee of the City have a financial interest in his or her own name or in the name of any other person or entity in the Matter?

Yes                       No

NOTE: If you checked "Yes" to Item D.1., proceed to Items D.2. and D.3. If you checked "No" to Item D.1., proceed to Part E.

2. Unless sold pursuant to a process of competitive bidding, or otherwise permitted, no City elected official or employee shall have a financial interest in his or her own name or in the name of any other person or entity in the purchase of any property that (i) belongs to the City, or (ii) is sold for taxes or assessments, or (iii) is sold by virtue of legal process at the suit of the City (collectively, "City Property Sale"). Compensation for property taken pursuant to the City's eminent domain power does not constitute a financial interest within the meaning of this Part D.

Does the Matter involve a City Property Sale?

Yes                       No

3. If you checked "Yes" to Item D.1., provide the names and business addresses of the City officials or employees having such interest and identify the nature of such interest:

Name	Business Address	Nature of Interest
<hr/>		
<hr/>		
<hr/>		

4. The Disclosing Party further certifies that no prohibited financial interest in the Matter will be acquired by any City official or employee.

**E. CERTIFICATION REGARDING SLAVERY ERA BUSINESS**

Please check either 1. or 2. below. If the Disclosing Party checks 2., the Disclosing Party must disclose below or in an attachment to this EDS all information required by paragraph 2. Failure to

comply with these disclosure requirements may make any contract entered into with the City in connection with the Matter voidable by the City.

X 1. The Disclosing Party verifies that the Disclosing Party has searched any and all records of the Disclosing Party and any and all predecessor entities regarding records of investments or profits from slavery or slaveholder insurance policies during the slavery era (including insurance policies issued to slaveholders that provided coverage for damage to or injury or death of their slaves), and the Disclosing Party has found no such records.

\_\_\_ 2. The Disclosing Party verifies that, as a result of conducting the search in step 1 above, the Disclosing Party has found records of investments or profits from slavery or slaveholder insurance policies. The Disclosing Party verifies that the following constitutes full disclosure of all such records, including the names of any and all slaves or slaveholders described in those records:

---

---

---

---

**SECTION VI -- CERTIFICATIONS FOR FEDERALLY FUNDED MATTERS**

**NOTE: If the Matter is federally funded, complete this Section VI. If the Matter is not federally funded, proceed to Section VII. For purposes of this Section VI, tax credits allocated by the City and proceeds of debt obligations of the City are not federal funding.**

**A. CERTIFICATION REGARDING LOBBYING**

1. List below the names of all persons or entities registered under the federal Lobbying Disclosure Act of 1995 who have made lobbying contacts on behalf of the Disclosing Party with respect to the Matter: (Add sheets if necessary):

N/A

---

---

---

(If no explanation appears or begins on the lines above, or if the letters "NA" or if the word "None" appear, it will be conclusively presumed that the Disclosing Party means that NO persons or entities registered under the Lobbying Disclosure Act of 1995 have made lobbying contacts on behalf of the Disclosing Party with respect to the Matter.)

2. The Disclosing Party has not spent and will not expend any federally appropriated funds to pay any person or entity listed in Paragraph A.1. above for his or her lobbying activities or to pay any person or entity to influence or attempt to influence an officer or employee of any agency, as defined by applicable federal law, a member of Congress, an officer or employee of Congress, or an employee of a member of Congress, in connection with the award of any federally funded contract, making any federally funded grant or loan, entering into any cooperative agreement, or to extend, continue, renew, amend, or modify any federally funded contract, grant, loan, or cooperative agreement.

3. The Disclosing Party will submit an updated certification at the end of each calendar quarter in which there occurs any event that materially affects the accuracy of the statements and information set forth in paragraphs A.1. and A.2. above.

4. The Disclosing Party certifies that either: (i) it is not an organization described in section 501(c)(4) of the Internal Revenue Code of 1986; or (ii) it is an organization described in section 501(c)(4) of the Internal Revenue Code of 1986 but has not engaged and will not engage in "Lobbying Activities".

5. If the Disclosing Party is the Applicant, the Disclosing Party must obtain certifications equal in form and substance to paragraphs A.1. through A.4. above from all subcontractors before it awards any subcontract and the Disclosing Party must maintain all such subcontractors' certifications for the duration of the Matter and must make such certifications promptly available to the City upon request.

## B. CERTIFICATION REGARDING EQUAL EMPLOYMENT OPPORTUNITY

If the Matter is federally funded, federal regulations require the Applicant and all proposed subcontractors to submit the following information with their bids or in writing at the outset of negotiations.

Is the Disclosing Party the Applicant?

Yes

No

If "Yes," answer the three questions below:

1. Have you developed and do you have on file affirmative action programs pursuant to applicable federal regulations? (See 41 CFR Part 60-2.)

Yes

No

2. Have you filed with the Joint Reporting Committee, the Director of the Office of Federal Contract Compliance Programs, or the Equal Employment Opportunity Commission all reports due under the applicable filing requirements?

Yes

No

3. Have you participated in any previous contracts or subcontracts subject to the equal opportunity clause?

Yes

No

If you checked "No" to question 1. or 2. above, please provide an explanation:

---

---

## **SECTION VII -- ACKNOWLEDGMENTS, CONTRACT INCORPORATION, COMPLIANCE, PENALTIES, DISCLOSURE**

The Disclosing Party understands and agrees that:

A. The certifications, disclosures, and acknowledgments contained in this EDS will become part of any contract or other agreement between the Applicant and the City in connection with the Matter, whether procurement, City assistance, or other City action, and are material inducements to the City's execution of any contract or taking other action with respect to the Matter. The Disclosing Party understands that it must comply with all statutes, ordinances, and regulations on which this EDS is based.

B. The City's Governmental Ethics and Campaign Financing Ordinances, Chapters 2-156 and 2-164 of the Municipal Code, impose certain duties and obligations on persons or entities seeking City contracts, work, business, or transactions. The full text of these ordinances and a training program is available online at [www.cityofchicago.org/Ethics](http://www.cityofchicago.org/Ethics), and may also be obtained from the City's Board of Ethics, 740 N.

Sedgwick St., Suite 500, Chicago, IL 60610, (312) 744-9660. The Disclosing Party must comply fully with the applicable ordinances.

C. If the City determines that any information provided in this EDS is false, incomplete or inaccurate, any contract or other agreement in connection with which it is submitted may be rescinded or be void or voidable, and the City may pursue any remedies under the contract or agreement (if not rescinded or void), at law, or in equity, including terminating the Disclosing Party's participation in the Matter and/or declining to allow the Disclosing Party to participate in other transactions with the City. Remedies at law for a false statement of material fact may include incarceration and an award to the City of treble damages.

D. It is the City's policy to make this document available to the public on its Internet site and/or upon request. Some or all of the information provided on this EDS and any attachments to this EDS may be made available to the public on the Internet, in response to a Freedom of Information Act request, or otherwise. By completing and signing this EDS, the Disclosing Party waives and releases any possible rights or claims which it may have against the City in connection with the public release of information contained in this EDS and also authorizes the City to verify the accuracy of any information submitted in this EDS.

E. The information provided in this EDS must be kept current. In the event of changes, the Disclosing Party must supplement this EDS up to the time the City takes action on the Matter. If the Matter is a contract being handled by the City's Department of Procurement Services, the Disclosing Party must update this EDS as the contract requires. **NOTE:** With respect to Matters subject to Article I of Chapter 1-23 of the Municipal Code (imposing **PERMANENT INELIGIBILITY** for certain specified offenses), the information provided herein regarding eligibility must be kept current for a longer period, as required by Chapter 1-23 and Section 2-154-020 of the Municipal Code.

The Disclosing Party represents and warrants that:

F.1. The Disclosing Party is not delinquent in the payment of any tax administered by the Illinois Department of Revenue, nor are the Disclosing Party or its Affiliated Entities delinquent in paying any fine, fee, tax or other charge owed to the City. This includes, but is not limited to, all water charges, sewer charges, license fees, parking tickets, property taxes or sales taxes.

F.2 If the Disclosing Party is the Applicant, the Disclosing Party and its Affiliated Entities will not use, nor permit their subcontractors to use, any facility listed by the U.S. E.P.A. on the federal Excluded Parties List System ("EPLS") maintained by the U. S. General Services Administration.

F.3 If the Disclosing Party is the Applicant, the Disclosing Party will obtain from any contractors/subcontractors hired or to be hired in connection with the Matter certifications equal in form and substance to those in F.1. and F.2. above and will not, without the prior written consent of the City, use any such contractor/subcontractor that does not provide such certifications or that the Disclosing Party has reason to believe has not provided or cannot provide truthful certifications.

NOTE: If the Disclosing Party cannot certify as to any of the items in F.1., F.2. or F.3. above, an explanatory statement must be attached to this EDS.

**CERTIFICATION**

Under penalty of perjury, the person signing below: (1) warrants that he/she is authorized to execute this EDS and Appendix A (if applicable) on behalf of the Disclosing Party, and (2) warrants that all certifications and statements contained in this EDS and Appendix A (if applicable) are true, accurate and complete as of the date furnished to the City.

NAHSHON DEVELOPMENT, LLC.

(Print or type name of Disclosing Party)

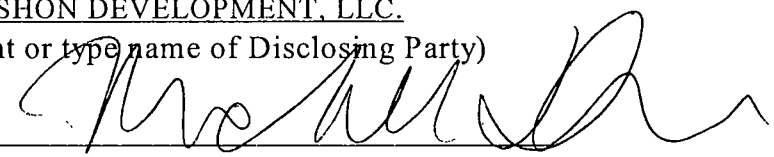
By:   
(Sign here)

MICHELLE DUBIN

(Print or type name of person signing)

President of WKN Inc, Managing Member of Nahshon Development, LLC\_

(Print or type title of person signing)

Signed and sworn to before me on (date) 08/22/2013,  
at LAKE County, IL (state).

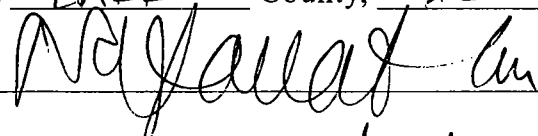
 Notary Public.

Commission expires: 11/02/15.

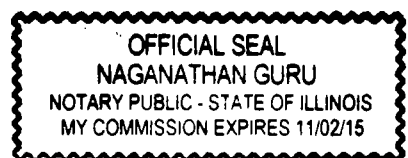

OFFICIAL SEAL  
MAGNANIMOUS  
NOTARY PUBLIC  
IN AND FOR THE STATE OF CALIFORNIA

**CITY OF CHICAGO  
ECONOMIC DISCLOSURE STATEMENT AND AFFIDAVIT  
APPENDIX A**

**FAMILIAL RELATIONSHIPS WITH ELECTED CITY OFFICIALS AND DEPARTMENT HEADS**

**This Appendix is to be completed only by (a) the Applicant, and (b) any legal entity which has a direct ownership interest in the Applicant exceeding 7.5 percent. It is not to be completed by any legal entity which has only an indirect ownership interest in the Applicant.**

Under Municipal Code Section 2-154-015, the Disclosing Party must disclose whether such Disclosing Party or any “Applicable Party” or any Spouse or Domestic Partner thereof currently has a “familial relationship” with any elected city official or department head. A “familial relationship” exists if, as of the date this EDS is signed, the Disclosing Party or any “Applicable Party” or any Spouse or Domestic Partner thereof is related to the mayor, any alderman, the city clerk, the city treasurer or any city department head as spouse or domestic partner or as any of the following, whether by blood or adoption: parent, child, brother or sister, aunt or uncle, niece or nephew, grandparent, grandchild, father-in-law, mother-in-law, son-in-law, daughter-in-law, stepfather or stepmother, stepson or stepdaughter, stepbrother or stepsister or half-brother or half-sister.

“Applicable Party” means (1) all executive officers of the Disclosing Party listed in Section II.B.1.a., if the Disclosing Party is a corporation; all partners of the Disclosing Party, if the Disclosing Party is a general partnership; all general partners and limited partners of the Disclosing Party, if the Disclosing Party is a limited partnership; all managers, managing members and members of the Disclosing Party, if the Disclosing Party is a limited liability company; (2) all principal officers of the Disclosing Party; and (3) any person having more than a 7.5 percent ownership interest in the Disclosing Party. “Principal officers” means the president, chief operating officer, executive director, chief financial officer, treasurer or secretary of a legal entity or any person exercising similar authority.

Does the Disclosing Party or any “Applicable Party” or any Spouse or Domestic Partner thereof currently have a “familial relationship” with an elected city official or department head?

Yes

No

If yes, please identify below (1) the name and title of such person, (2) the name of the legal entity to which such person is connected; (3) the name and title of the elected city official or department head to whom such person has a familial relationship, and (4) the precise nature of such familial relationship.

---

---

---

Exhibit A

Name (indicate whether retained or anticipated to be retained)	Business Address	Relationship to Disclosing Party (subcontractor, attorney, lobbyist, etc.)	Fees (indicate whether paid or estimated) NO TE "hourly rate" or "t.b.d." is not an acceptable response
Thompson Coburn LLP	Thompson Coburn LLP 55 East Monroe St. 37th Floor Chicago, IL	Attorney	\$20,000 Estimated
Miller & Cooper	Miller Cooper & Co., Ltd 1751 Lake Cook Road, Suite 400 Deerfield, Illinois 60015	Accountants	\$10,000 Estimated
Dubin Consulting Inc	4252 N Cicero Ave Chicago, IL 60641	Project Consultant	\$5,000 Estimated
PappaGeorge Haymes Partners	PappaGeorge Haymes Partners 640 North LaSalle Suite 400 Chicago, IL 60654	Architect	\$20,000 Estimated
Tim Hammersmith	Masuda, Funai, Eifert & Mitchell, LTD 203 N. LaSalle Street, Suite 2500 Chicago, IL 60601	Attorney	In Excess of \$1,000 00
Renee A. Beaver	Novogradac & Company LLP 1100 Superior Avenue, Suite 900 Cleveland, OH 44114	Attorney	In Excess of \$1,000 00



**CITY OF CHICAGO  
ECONOMIC DISCLOSURE STATEMENT  
AND AFFIDAVIT**

**SECTION I -- GENERAL INFORMATION**

A. Legal name of the Disclosing Party submitting this EDS. Include d/b/a/ if applicable:  
WKN INC.

**☞ Check ONE of the following three boxes:**

Indicate whether the Disclosing Party submitting this EDS is:

1.  the Applicant  
OR

2.  a legal entity holding a direct or indirect interest in the Applicant. State the legal name of the Applicant in which the Disclosing Party holds an interest:           
the current owner and seller of subject property to the future developer\_ OR

3.  a legal entity with a right of control (see Section II.B.1.) State the legal name of the entity in which the Disclosing Party holds a right of control: Nahshon Development, L.L.C.

B. Business address of the Disclosing Party: 4252 N CICERO AVE  
CHICAGO, IL 60641

C. Telephone: 773-427-2400 Fax:          Email: gurun@dubinresidential.com Name of contact person: Naganat Guru

E. Federal Employer Identification No. (if you have one):         

F. Brief description of contract, transaction or other undertaking (referred to below as the "Matter") to which this EDS pertains. (Include project number and location of property, if applicable):

Planned Development Amendment for the property located at 3670-3688 & 3700-3738 North Milwaukee.

G. Which City agency or department is requesting this EDS? Dept. of Housing and Economic Development

If the Matter is a contract being handled by the City's Department of Procurement Services, please complete the following:

Specification #          and Contract #

**SECTION II -- DISCLOSURE OF OWNERSHIP INTERESTS**

**A. NATURE OF THE DISCLOSING PARTY**

1. Indicate the nature of the Disclosing Party:

- Person
- Publicly registered business corporation
- Privately held business corporation
- Sole proprietorship
- General partnership
- Limited partnership
- Trust
- Limited liability company
- Limited liability partnership
- Joint venture
- Not-for-profit corporation  
(Is the not-for-profit corporation also a 501(c)(3))?  
 Yes  No
- Other (please specify)

2. For legal entities, the state (or foreign country) of incorporation or organization, if applicable:

ILLINOIS

3. For legal entities not organized in the State of Illinois: Has the organization registered to do business in the State of Illinois as a foreign entity?

- Yes  No  N/A

**B. IF THE DISCLOSING PARTY IS A LEGAL ENTITY:**

1. List below the full names and titles of all executive officers and all directors of the entity.

**NOTE:** For not-for-profit corporations, also list below all members, if any, which are legal entities. If there are no such members, write "no members." For trusts, estates or other similar entities, list below the legal titleholder(s).

If the entity is a general partnership, limited partnership, limited liability company, limited liability partnership or joint venture, list below the name and title of each general partner, managing member, manager or any other person or entity that controls the day-to-day management of the Disclosing Party. **NOTE:** Each legal entity listed below must submit an EDS on its own behalf.

Name	Title
Michelle Dubin	President
Naganathan Guru	Secretary

2. Please provide the following information concerning each person or entity having a direct or indirect beneficial interest (including ownership) in excess of 7.5% of the Disclosing Party. Examples of such an interest include shares in a corporation, partnership interest in a partnership or joint venture,

interest of a member or manager in a limited liability company, or interest of a beneficiary of a trust, estate or other similar entity. If none, state "None." **NOTE:** Pursuant to Section 2-154-030 of the Municipal Code of Chicago ("Municipal Code"), the City may require any such additional information from any applicant which is reasonably intended to achieve full disclosure.

Name	Business Address	Percentage Interest in the Disclosing Party
<u>M.J. Dubin Revocable Trust</u>	<u>4252 N. Cicero Ave, Chicago IL</u>	<u>80.0%</u>
<u>Naganathan Guru Revocable Trust</u>	<u>4252 N. Cicero Ave, Chicago IL</u>	<u>20.0%</u>

### SECTION III -- BUSINESS RELATIONSHIPS WITH CITY ELECTED OFFICIALS

Has the Disclosing Party had a "business relationship," as defined in Chapter 2-156 of the Municipal Code, with any City elected official in the 12 months before the date this EDS is signed?

Yes                       No

If yes, please identify below the name(s) of such City elected official(s) and describe such relationship(s):

---

---

### SECTION IV -- DISCLOSURE OF SUBCONTRACTORS AND OTHER RETAINED PARTIES

The Disclosing Party must disclose the name and business address of each subcontractor, attorney, lobbyist, accountant, consultant and any other person or entity whom the Disclosing Party has retained or expects to retain in connection with the Matter, as well as the nature of the relationship, and the total amount of the fees paid or estimated to be paid. The Disclosing Party is not required to disclose employees who are paid solely through the Disclosing Party's regular payroll.

"Lobbyist" means any person or entity who undertakes to influence any legislative or administrative action on behalf of any person or entity other than: (1) a not-for-profit entity, on an unpaid basis, or (2) himself. "Lobbyist" also means any person or entity any part of whose duties as an employee of another includes undertaking to influence any legislative or administrative action.

If the Disclosing Party is uncertain whether a disclosure is required under this Section, the Disclosing Party must either ask the City whether disclosure is required or make the disclosure.

Name (indicate whether retained or anticipated to be retained)	Business Address	Relationship to Disclosing Party (subcontractor, attorney, lobbyist, etc.)	Fees (indicate whether paid or estimated.) <b>NOTE:</b> "hourly rate" or "t.b.d." is not an acceptable response.
--	------------------	--	--

---



---



---

(Add sheets if necessary)

Check here if the Disclosing Party has not retained, nor expects to retain, any such persons or entities.

**SECTION V -- CERTIFICATIONS**

**A. COURT-ORDERED CHILD SUPPORT COMPLIANCE**

Under Municipal Code Section 2-92-415, substantial owners of business entities that contract with the City must remain in compliance with their child support obligations throughout the contract's term.

Has any person who directly or indirectly owns 10% or more of the Disclosing Party been declared in arrearage on any child support obligations by any Illinois court of competent jurisdiction?

Yes       No       No person directly or indirectly owns 10% or more of the Disclosing Party.

If "Yes," has the person entered into a court-approved agreement for payment of all support owed and is the person in compliance with that agreement?

Yes       No

**B. FURTHER CERTIFICATIONS**

1. Pursuant to Municipal Code Chapter 1-23, Article I ("Article I")(which the Applicant should consult for defined terms (e.g., "doing business") and legal requirements), if the Disclosing Party submitting this EDS is the Applicant and is doing business with the City, then the Disclosing Party certifies as follows: (i) neither the Applicant nor any controlling person is currently indicted or charged with, or has admitted guilt of, or has ever been convicted of, or placed under supervision for, any criminal offense involving actual, attempted, or conspiracy to commit bribery, theft, fraud, forgery, perjury, dishonesty or deceit against an officer or employee of the City or any sister agency; and (ii) the Applicant understands and acknowledges that compliance with Article I is a continuing requirement for doing business with the City. **NOTE:** If Article I applies to the Applicant, the permanent compliance timeframe in Article I supersedes some five-year compliance timeframes in certifications 2 and 3 below.

2. The Disclosing Party and, if the Disclosing Party is a legal entity, all of those persons or entities identified in Section II.B.1. of this EDS:

- a. are not presently debarred, suspended, proposed for debarment, declared ineligible or voluntarily excluded from any transactions by any federal, state or local unit of government;
- b. have not, within a five-year period preceding the date of this EDS, been convicted of a criminal offense, adjudged guilty, or had a civil judgment rendered against them in connection with: obtaining, attempting to obtain, or performing a public (federal, state or local) transaction or contract under a public transaction; a violation of federal or state antitrust statutes; fraud; embezzlement; theft; forgery; bribery; falsification or destruction of records; making false statements; or receiving stolen property;
- c. are not presently indicted for, or criminally or civilly charged by, a governmental entity (federal, state or local) with committing any of the offenses set forth in clause B.2.b. of this Section V;
- d. have not, within a five-year period preceding the date of this EDS, had one or more public transactions (federal, state or local) terminated for cause or default; and
- e. have not, within a five-year period preceding the date of this EDS, been convicted, adjudged guilty, or found liable in a civil proceeding, or in any criminal or civil action, including actions concerning environmental violations, instituted by the City or by the federal government, any state, or any other unit of local government.

3. The certifications in subparts 3, 4 and 5 concern:

- the Disclosing Party;
- any "Contractor" (meaning any contractor or subcontractor used by the Disclosing Party in connection with the Matter, including but not limited to all persons or legal entities disclosed under Section IV, "Disclosure of Subcontractors and Other Retained Parties");
- any "Affiliated Entity" (meaning a person or entity that, directly or indirectly: controls the Disclosing Party, is controlled by the Disclosing Party, or is, with the Disclosing Party, under common control of another person or entity. Indicia of control include, without limitation: interlocking management or ownership; identity of interests among family members, shared facilities and equipment; common use of employees; or organization of a business entity following the ineligibility of a business entity to do business with federal or state or local government, including the City, using substantially the same management, ownership, or principals as the ineligible entity); with respect to Contractors, the term Affiliated Entity means a person or entity that directly or indirectly controls the Contractor, is controlled by it, or, with the Contractor, is under common control of another person or entity;
- any responsible official of the Disclosing Party, any Contractor or any Affiliated Entity or any other official, agent or employee of the Disclosing Party, any Contractor or any Affiliated Entity, acting pursuant to the direction or authorization of a responsible official of the Disclosing Party, any Contractor or any Affiliated Entity (collectively "Agents").

Neither the Disclosing Party, nor any Contractor, nor any Affiliated Entity of either the Disclosing Party or any Contractor nor any Agents have, during the five years before the date this EDS is signed, or, with respect to a Contractor, an Affiliated Entity, or an Affiliated Entity of a Contractor during the five years before the date of such Contractor's or Affiliated Entity's contract or engagement in connection with the Matter:

- a. bribed or attempted to bribe, or been convicted or adjudged guilty of bribery or attempting to bribe, a public officer or employee of the City, the State of Illinois, or any agency of the federal government or of any state or local government in the United States of America, in that officer's or employee's official capacity;
- b. agreed or colluded with other bidders or prospective bidders, or been a party to any such agreement, or been convicted or adjudged guilty of agreement or collusion among bidders or prospective bidders, in restraint of freedom of competition by agreement to bid a fixed price or otherwise; or
- c. made an admission of such conduct described in a. or b. above that is a matter of record, but have not been prosecuted for such conduct; or
- d. violated the provisions of Municipal Code Section 2-92-610 (Living Wage Ordinance).

4. Neither the Disclosing Party, Affiliated Entity or Contractor, or any of their employees, officials, agents or partners, is barred from contracting with any unit of state or local government as a result of engaging in or being convicted of (1) bid-rigging in violation of 720 ILCS 5/33E-3; (2) bid-rotating in violation of 720 ILCS 5/33E-4; or (3) any similar offense of any state or of the United States of America that contains the same elements as the offense of bid-rigging or bid-rotating.

5. Neither the Disclosing Party nor any Affiliated Entity is listed on any of the following lists maintained by the Office of Foreign Assets Control of the U.S. Department of the Treasury or the Bureau of Industry and Security of the U.S. Department of Commerce or their successors: the Specially Designated Nationals List, the Denied Persons List, the Unverified List, the Entity List and the Debarred List.

6. The Disclosing Party understands and shall comply with the applicable requirements of Chapters 2-55 (Legislative Inspector General), 2-56 (Inspector General) and 2-156 (Governmental Ethics) of the Municipal Code.

7. If the Disclosing Party is unable to certify to any of the above statements in this Part B (Further Certifications), the Disclosing Party must explain below:

---

---

N/A

---

---

If the letters "NA," the word "None," or no response appears on the lines above, it will be conclusively presumed that the Disclosing Party certified to the above statements.

8. To the best of the Disclosing Party's knowledge after reasonable inquiry, the following is a complete list of all current employees of the Disclosing Party who were, at any time during the 12-month period preceding the execution date of this EDS, an employee, or elected or appointed official, of the City of Chicago (if none, indicate with "N/A" or "none").

---

---

---

9. To the best of the Disclosing Party's knowledge after reasonable inquiry, the following is a complete list of all gifts that the Disclosing Party has given or caused to be given, at any time during the 12-month period preceding the execution date of this EDS, to an employee, or elected or appointed official, of the City of Chicago. For purposes of this statement, a "gift" does not include: (i) anything made generally available to City employees or to the general public, or (ii) food or drink provided in the course of official City business and having a retail value of less than \$20 per recipient (if none, indicate with "N/A" or "none"). As to any gift listed below, please also list the name of the City recipient.

---

---

---

### C. CERTIFICATION OF STATUS AS FINANCIAL INSTITUTION

1. The Disclosing Party certifies that the Disclosing Party (check one)

is                       is not

a "financial institution" as defined in Section 2-32-455(b) of the Municipal Code.

2. If the Disclosing Party IS a financial institution, then the Disclosing Party pledges:

"We are not and will not become a predatory lender as defined in Chapter 2-32 of the Municipal Code. We further pledge that none of our affiliates is, and none of them will become, a predatory lender as defined in Chapter 2-32 of the Municipal Code. We understand that becoming a predatory lender or becoming an affiliate of a predatory lender may result in the loss of the privilege of doing business with the City."

If the Disclosing Party is unable to make this pledge because it or any of its affiliates (as defined in Section 2-32-455(b) of the Municipal Code) is a predatory lender within the meaning of Chapter 2-32 of the Municipal Code, explain here (attach additional pages if necessary):

---

---

---

If the letters "NA," the word "None," or no response appears on the lines above, it will be conclusively presumed that the Disclosing Party certified to the above statements.

**D. CERTIFICATION REGARDING INTEREST IN CITY BUSINESS**

Any words or terms that are defined in Chapter 2-156 of the Municipal Code have the same meanings when used in this Part D.

1. In accordance with Section 2-156-110 of the Municipal Code: Does any official or employee of the City have a financial interest in his or her own name or in the name of any other person or entity in the Matter?

Yes                       No

NOTE: If you checked "Yes" to Item D.1., proceed to Items D.2. and D.3. If you checked "No" to Item D.1., proceed to Part E.

2. Unless sold pursuant to a process of competitive bidding, or otherwise permitted, no City elected official or employee shall have a financial interest in his or her own name or in the name of any other person or entity in the purchase of any property that (i) belongs to the City, or (ii) is sold for taxes or assessments, or (iii) is sold by virtue of legal process at the suit of the City (collectively, "City Property Sale"). Compensation for property taken pursuant to the City's eminent domain power does not constitute a financial interest within the meaning of this Part D.

Does the Matter involve a City Property Sale?

Yes                       No

3. If you checked "Yes" to Item D.1., provide the names and business addresses of the City officials or employees having such interest and identify the nature of such interest:

Name	Business Address	Nature of Interest

4. The Disclosing Party further certifies that no prohibited financial interest in the Matter will be acquired by any City official or employee.

**E. CERTIFICATION REGARDING SLAVERY ERA BUSINESS**

Please check either 1. or 2. below. If the Disclosing Party checks 2., the Disclosing Party must disclose below or in an attachment to this EDS all information required by paragraph 2. Failure to



comply with these disclosure requirements may make any contract entered into with the City in connection with the Matter voidable by the City.

X 1. The Disclosing Party verifies that the Disclosing Party has searched any and all records of the Disclosing Party and any and all predecessor entities regarding records of investments or profits from slavery or slaveholder insurance policies during the slavery era (including insurance policies issued to slaveholders that provided coverage for damage to or injury or death of their slaves), and the Disclosing Party has found no such records.

2. The Disclosing Party verifies that, as a result of conducting the search in step 1 above, the Disclosing Party has found records of investments or profits from slavery or slaveholder insurance policies. The Disclosing Party verifies that the following constitutes full disclosure of all such records, including the names of any and all slaves or slaveholders described in those records:

---

---

---

---

## SECTION VI -- CERTIFICATIONS FOR FEDERALLY FUNDED MATTERS

**NOTE: If the Matter is federally funded, complete this Section VI. If the Matter is not federally funded, proceed to Section VII.** For purposes of this Section VI, tax credits allocated by the City and proceeds of debt obligations of the City are not federal funding.

### A. CERTIFICATION REGARDING LOBBYING

1. List below the names of all persons or entities registered under the federal Lobbying Disclosure Act of 1995 who have made lobbying contacts on behalf of the Disclosing Party with respect to the Matter: (Add sheets if necessary):

N/A

---

---

---

(If no explanation appears or begins on the lines above, or if the letters "NA" or if the word "None" appear, it will be conclusively presumed that the Disclosing Party means that NO persons or entities registered under the Lobbying Disclosure Act of 1995 have made lobbying contacts on behalf of the Disclosing Party with respect to the Matter.)

2. The Disclosing Party has not spent and will not expend any federally appropriated funds to pay any person or entity listed in Paragraph A.1. above for his or her lobbying activities or to pay any person or entity to influence or attempt to influence an officer or employee of any agency, as defined by applicable federal law, a member of Congress, an officer or employee of Congress, or an employee of a member of Congress, in connection with the award of any federally funded contract, making any federally funded grant or loan, entering into any cooperative agreement, or to extend, continue, renew, amend, or modify any federally funded contract, grant, loan, or cooperative agreement.

3. The Disclosing Party will submit an updated certification at the end of each calendar quarter in which there occurs any event that materially affects the accuracy of the statements and information set forth in paragraphs A.1. and A.2. above.

4. The Disclosing Party certifies that either: (i) it is not an organization described in section 501(c)(4) of the Internal Revenue Code of 1986; or (ii) it is an organization described in section 501(c)(4) of the Internal Revenue Code of 1986 but has not engaged and will not engage in "Lobbying Activities".

5. If the Disclosing Party is the Applicant, the Disclosing Party must obtain certifications equal in form and substance to paragraphs A.1. through A.4. above from all subcontractors before it awards any subcontract and the Disclosing Party must maintain all such subcontractors' certifications for the duration of the Matter and must make such certifications promptly available to the City upon request.

## B. CERTIFICATION REGARDING EQUAL EMPLOYMENT OPPORTUNITY

If the Matter is federally funded, federal regulations require the Applicant and all proposed subcontractors to submit the following information with their bids or in writing at the outset of negotiations.

Is the Disclosing Party the Applicant?

Yes                       No

If "Yes," answer the three questions below:

1. Have you developed and do you have on file affirmative action programs pursuant to applicable federal regulations? (See 41 CFR Part 60-2.)

Yes                       No

2. Have you filed with the Joint Reporting Committee, the Director of the Office of Federal Contract Compliance Programs, or the Equal Employment Opportunity Commission all reports due under the applicable filing requirements?

Yes                       No

3. Have you participated in any previous contracts or subcontracts subject to the equal opportunity clause?

Yes                       No

If you checked "No" to question 1. or 2. above, please provide an explanation:

---

---

## SECTION VII -- ACKNOWLEDGMENTS, CONTRACT INCORPORATION, COMPLIANCE, PENALTIES, DISCLOSURE

The Disclosing Party understands and agrees that:

A. The certifications, disclosures, and acknowledgments contained in this EDS will become part of any contract or other agreement between the Applicant and the City in connection with the Matter, whether procurement, City assistance, or other City action, and are material inducements to the City's execution of any contract or taking other action with respect to the Matter. The Disclosing Party understands that it must comply with all statutes, ordinances, and regulations on which this EDS is based.

B. The City's Governmental Ethics and Campaign Financing Ordinances, Chapters 2-156 and 2-164 of the Municipal Code, impose certain duties and obligations on persons or entities seeking City contracts, work, business, or transactions. The full text of these ordinances and a training program is available on line at [www.cityofchicago.org/Ethics](http://www.cityofchicago.org/Ethics), and may also be obtained from the City's Board of Ethics, 740 N.

Sedgwick St., Suite 500, Chicago, IL 60610, (312) 744-9660. The Disclosing Party must comply fully with the applicable ordinances.

C. If the City determines that any information provided in this EDS is false, incomplete or inaccurate, any contract or other agreement in connection with which it is submitted may be rescinded or be void or voidable, and the City may pursue any remedies under the contract or agreement (if not rescinded or void), at law, or in equity, including terminating the Disclosing Party's participation in the Matter and/or declining to allow the Disclosing Party to participate in other transactions with the City. Remedies at law for a false statement of material fact may include incarceration and an award to the City of treble damages.

D. It is the City's policy to make this document available to the public on its Internet site and/or upon request. Some or all of the information provided on this EDS and any attachments to this EDS may be made available to the public on the Internet, in response to a Freedom of Information Act request, or otherwise. By completing and signing this EDS, the Disclosing Party waives and releases any possible rights or claims which it may have against the City in connection with the public release of information contained in this EDS and also authorizes the City to verify the accuracy of any information submitted in this EDS.

E. The information provided in this EDS must be kept current. In the event of changes, the Disclosing Party must supplement this EDS up to the time the City takes action on the Matter. If the Matter is a contract being handled by the City's Department of Procurement Services, the Disclosing Party must update this EDS as the contract requires. **NOTE:** With respect to Matters subject to Article I of Chapter 1-23 of the Municipal Code (imposing **PERMANENT INELIGIBILITY** for certain specified offenses), the information provided herein regarding eligibility must be kept current for a longer period, as required by Chapter 1-23 and Section 2-154-020 of the Municipal Code.

The Disclosing Party represents and warrants that:

F.1. The Disclosing Party is not delinquent in the payment of any tax administered by the Illinois Department of Revenue, nor are the Disclosing Party or its Affiliated Entities delinquent in paying any fine, fee, tax or other charge owed to the City. This includes, but is not limited to, all water charges, sewer charges, license fees, parking tickets, property taxes or sales taxes.

F.2 If the Disclosing Party is the Applicant, the Disclosing Party and its Affiliated Entities will not use, nor permit their subcontractors to use, any facility listed by the U.S. E.P.A. on the federal Excluded Parties List System ("EPLS") maintained by the U. S. General Services Administration.

F.3 If the Disclosing Party is the Applicant, the Disclosing Party will obtain from any contractors/subcontractors hired or to be hired in connection with the Matter certifications equal in form and substance to those in F.1. and F.2. above and will not, without the prior written consent of the City, use any such contractor/subcontractor that does not provide such certifications or that the Disclosing Party has reason to believe has not provided or cannot provide truthful certifications.

NOTE: If the Disclosing Party cannot certify as to any of the items in F.1., F.2. or F.3. above, an explanatory statement must be attached to this EDS.

**CERTIFICATION**

Under penalty of perjury, the person signing below: (1) warrants that he/she is authorized to execute this EDS and Appendix A (if applicable) on behalf of the Disclosing Party, and (2) warrants that all certifications and statements contained in this EDS and Appendix A (if applicable) are true, accurate and complete as of the date furnished to the City.

WKN INC.

(Print or type name of Disclosing Party)

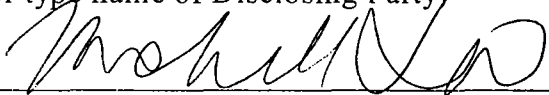
By:   
(Sign here)

MICHELLE DUBIN  
(Print or type name of person signing)

PRESIDENT  
(Print or type title of person signing)

Signed and sworn to before me on (date) 08/22/2013,  
at LAKE County, IL (state).

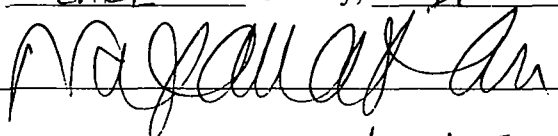
 Notary Public.

Commission expires: 11/02/15.



OFFICE BEAR  
NAGAMATHAN PIRU  
NOTARY PUBLIC  
STATE OF CALIFORNIA  
COMM. NO. 123456

**CITY OF CHICAGO  
ECONOMIC DISCLOSURE STATEMENT AND AFFIDAVIT  
APPENDIX A**

**FAMILIAL RELATIONSHIPS WITH ELECTED CITY OFFICIALS AND DEPARTMENT HEADS**

**This Appendix is to be completed only by (a) the Applicant, and (b) any legal entity which has a direct ownership interest in the Applicant exceeding 7.5 percent. It is not to be completed by any legal entity which has only an indirect ownership interest in the Applicant.**

Under Municipal Code Section 2-154-015, the Disclosing Party must disclose whether such Disclosing Party or any “Applicable Party” or any Spouse or Domestic Partner thereof currently has a “familial relationship” with any elected city official or department head. A “familial relationship” exists if, as of the date this EDS is signed, the Disclosing Party or any “Applicable Party” or any Spouse or Domestic Partner thereof is related to the mayor, any alderman, the city clerk, the city treasurer or any city department head as spouse or domestic partner or as any of the following, whether by blood or adoption: parent, child, brother or sister, aunt or uncle, niece or nephew, grandparent, grandchild, father-in-law, mother-in-law, son-in-law, daughter-in-law, stepfather or stepmother, stepson or stepdaughter, stepbrother or stepsister or half-brother or half-sister.

“Applicable Party” means (1) all executive officers of the Disclosing Party listed in Section II.B.1.a., if the Disclosing Party is a corporation; all partners of the Disclosing Party, if the Disclosing Party is a general partnership; all general partners and limited partners of the Disclosing Party, if the Disclosing Party is a limited partnership; all managers, managing members and members of the Disclosing Party, if the Disclosing Party is a limited liability company; (2) all principal officers of the Disclosing Party; and (3) any person having more than a 7.5 percent ownership interest in the Disclosing Party. “Principal officers” means the president, chief operating officer, executive director, chief financial officer, treasurer or secretary of a legal entity or any person exercising similar authority.

Does the Disclosing Party or any “Applicable Party” or any Spouse or Domestic Partner thereof currently have a “familial relationship” with an elected city official or department head?

Yes

No

If yes, please identify below (1) the name and title of such person, (2) the name of the legal entity to which such person is connected; (3) the name and title of the elected city official or department head to whom such person has a familial relationship, and (4) the precise nature of such familial relationship.

---

---

---

**CITY OF CHICAGO  
ECONOMIC DISCLOSURE STATEMENT  
AND AFFIDAVIT**

**SECTION I -- GENERAL INFORMATION**

A. Legal name of the Disclosing Party submitting this EDS. Include d/b/a/ if applicable:

NAGANATHAN GURU REVOCABLE TRUST

---

**Check ONE of the following three boxes:**

Indicate whether the Disclosing Party submitting this EDS is:

1.  the Applicant

OR

2.  a legal entity holding a direct or indirect interest in the Applicant. State the legal name of the Applicant in which the Disclosing Party holds an interest: \_\_\_\_\_

OR

3.  a legal entity with a right of control (see Section II.B.1.) State the legal name of the entity in which the Disclosing Party holds a right of control: Nahshon Development, LLC

B. Business address of the Disclosing Party: \_\_\_\_\_

C. Telephone: \_\_\_\_\_

Fax: \_\_\_\_\_

Em: \_\_\_\_\_

D. Name of contact person: Naganathan Guru

E. Federal Employer Identification No. (if you have one): \_\_\_\_\_

F. Brief description of contract, transaction or other undertaking (referred to below as the "Matter") to which this EDS pertains. (Include project number and location of property, if applicable):

Planned Development Amendment for the property located at 3670-3688 & 3700-3738 North

Milwaukee.

G. Which City agency or department is requesting this EDS? Dept. of Housing and Economic Development

If the Matter is a contract being handled by the City's Department of Procurement Services, please complete the following:

Specification # \_\_\_\_\_ and Contract # \_\_\_\_\_

**SECTION II -- DISCLOSURE OF OWNERSHIP INTERESTS**

**A. NATURE OF THE DISCLOSING PARTY**

1. Indicate the nature of the Disclosing Party:

- Person  Limited liability company
  - Publicly registered business corporation  Limited liability partnership
  - Privately held business corporation  Joint venture
  - Sole proprietorship  Not-for-profit corporation
  - General partnership (Is the not-for-profit corporation also a 501(c)(3))?
  - Limited partnership  Yes  No
  - Trust  Other (please specify)
- 

2. For legal entities, the state (or foreign country) of incorporation or organization, if applicable:

ILLINOIS

3. For legal entities not organized in the State of Illinois: Has the organization registered to do business in the State of Illinois as a foreign entity?

- Yes  No  N/A

**B. IF THE DISCLOSING PARTY IS A LEGAL ENTITY:**

1. List below the full names and titles of all executive officers and all directors of the entity.

**NOTE:** For not-for-profit corporations, also list below all members, if any, which are legal entities. If there are no such members, write "no members." For trusts, estates or other similar entities, list below the legal titleholder(s).

If the entity is a general partnership, limited partnership, limited liability company, limited liability partnership or joint venture, list below the name and title of each general partner, managing member, manager or any other person or entity that controls the day-to-day management of the Disclosing Party.

**NOTE:** Each legal entity listed below must submit an EDS on its own behalf.

Name	Title
Naganathan Guru	Trustee

2. Please provide the following information concerning each person or entity having a direct or indirect beneficial interest (including ownership) in excess of 7.5% of the Disclosing Party. Examples of such an interest include shares in a corporation, partnership interest in a partnership or joint venture,



interest of a member or manager in a limited liability company, or interest of a beneficiary of a trust, estate or other similar entity. If none, state "None." **NOTE:** Pursuant to Section 2-154-030 of the Municipal Code of Chicago ("Municipal Code"), the City may require any such additional information from any applicant which is reasonably intended to achieve full disclosure.

Name	Business Address	Percentage Interest in the Disclosing Party
<u>Naganathan Guru</u>	<u>4252 N. Cicero Ave, Chicago IL</u>	<u>100%</u>

**SECTION III -- BUSINESS RELATIONSHIPS WITH CITY ELECTED OFFICIALS**

Has the Disclosing Party had a "business relationship," as defined in Chapter 2-156 of the Municipal Code, with any City elected official in the 12 months before the date this EDS is signed?

Yes                       No

If yes, please identify below the name(s) of such City elected official(s) and describe such relationship(s):

---

---

**SECTION IV -- DISCLOSURE OF SUBCONTRACTORS AND OTHER RETAINED PARTIES**

The Disclosing Party must disclose the name and business address of each subcontractor, attorney, lobbyist, accountant, consultant and any other person or entity whom the Disclosing Party has retained or expects to retain in connection with the Matter, as well as the nature of the relationship, and the total amount of the fees paid or estimated to be paid. The Disclosing Party is not required to disclose employees who are paid solely through the Disclosing Party's regular payroll.

“Lobbyist” means any person or entity who undertakes to influence any legislative or administrative action on behalf of any person or entity other than: (1) a not-for-profit entity, on an unpaid basis, or (2) himself. “Lobbyist” also means any person or entity any part of whose duties as an employee of another includes undertaking to influence any legislative or administrative action.

If the Disclosing Party is uncertain whether a disclosure is required under this Section, the Disclosing Party must either ask the City whether disclosure is required or make the disclosure.

Name (indicate whether retained or anticipated to be retained)	Business Address	Relationship to Disclosing Party (subcontractor, attorney, lobbyist, etc.)	Fees (indicate whether paid or estimated.) <b>NOTE:</b> "hourly rate" or "t.b.d." is not an acceptable response.
--	------------------	--	--

---



---



---

(Add sheets if necessary)

[X] Check here if the Disclosing Party has not retained, nor expects to retain, any such persons or entities.

**SECTION V -- CERTIFICATIONS**

**A. COURT-ORDERED CHILD SUPPORT COMPLIANCE**

Under Municipal Code Section 2-92-415, substantial owners of business entities that contract with the City must remain in compliance with their child support obligations throughout the contract's term.

Has any person who directly or indirectly owns 10% or more of the Disclosing Party been declared in arrearage on any child support obligations by any Illinois court of competent jurisdiction?

Yes       No       No person directly or indirectly owns 10% or more of the Disclosing Party.

If "Yes," has the person entered into a court-approved agreement for payment of all support owed and is the person in compliance with that agreement?

Yes       No

**B. FURTHER CERTIFICATIONS**

1. Pursuant to Municipal Code Chapter 1-23, Article I ("Article I")(which the Applicant should consult for defined terms (e.g., "doing business") and legal requirements), if the Disclosing Party submitting this EDS is the Applicant and is doing business with the City, then the Disclosing Party certifies as follows: (i) neither the Applicant nor any controlling person is currently indicted or charged with, or has admitted guilt of, or has ever been convicted of, or placed under supervision for, any criminal offense involving actual, attempted, or conspiracy to commit bribery, theft, fraud, forgery, perjury, dishonesty or deceit against an officer or employee of the City or any sister agency; and (ii) the Applicant understands and acknowledges that compliance with Article I is a continuing requirement for doing business with the City. NOTE: If Article I applies to the Applicant, the permanent compliance timeframe in Article I supersedes some five-year compliance timeframes in certifications 2 and 3 below.

2. The Disclosing Party and, if the Disclosing Party is a legal entity, all of those persons or entities identified in Section II.B.1. of this EDS:

- a. are not presently debarred, suspended, proposed for debarment, declared ineligible or voluntarily excluded from any transactions by any federal, state or local unit of government;
- b. have not, within a five-year period preceding the date of this EDS, been convicted of a criminal offense, adjudged guilty, or had a civil judgment rendered against them in connection with: obtaining, attempting to obtain, or performing a public (federal, state or local) transaction or contract under a public transaction; a violation of federal or state antitrust statutes; fraud; embezzlement; theft; forgery; bribery; falsification or destruction of records; making false statements; or receiving stolen property;
- c. are not presently indicted for, or criminally or civilly charged by, a governmental entity (federal, state or local) with committing any of the offenses set forth in clause B.2.b. of this Section V;
- d. have not, within a five-year period preceding the date of this EDS, had one or more public transactions (federal, state or local) terminated for cause or default; and
- e. have not, within a five-year period preceding the date of this EDS, been convicted, adjudged guilty, or found liable in a civil proceeding, or in any criminal or civil action, including actions concerning environmental violations, instituted by the City or by the federal government, any state, or any other unit of local government.

3. The certifications in subparts 3, 4 and 5 concern:

- the Disclosing Party;
- any "Contractor" (meaning any contractor or subcontractor used by the Disclosing Party in connection with the Matter, including but not limited to all persons or legal entities disclosed under Section IV, "Disclosure of Subcontractors and Other Retained Parties");
- any "Affiliated Entity" (meaning a person or entity that, directly or indirectly: controls the Disclosing Party, is controlled by the Disclosing Party, or is, with the Disclosing Party, under common control of another person or entity. Indicia of control include, without limitation: interlocking management or ownership; identity of interests among family members, shared facilities and equipment; common use of employees; or organization of a business entity following the ineligibility of a business entity to do business with federal or state or local government, including the City, using substantially the same management, ownership, or principals as the ineligible entity); with respect to Contractors, the term Affiliated Entity means a person or entity that directly or indirectly controls the Contractor, is controlled by it, or, with the Contractor, is under common control of another person or entity;
- any responsible official of the Disclosing Party, any Contractor or any Affiliated Entity or any other official, agent or employee of the Disclosing Party, any Contractor or any Affiliated Entity, acting pursuant to the direction or authorization of a responsible official of the Disclosing Party, any Contractor or any Affiliated Entity (collectively "Agents").

Neither the Disclosing Party, nor any Contractor, nor any Affiliated Entity of either the Disclosing Party or any Contractor nor any Agents have, during the five years before the date this EDS is signed, or, with respect to a Contractor, an Affiliated Entity, or an Affiliated Entity of a Contractor during the five years before the date of such Contractor's or Affiliated Entity's contract or engagement in connection with the Matter:

- a. bribed or attempted to bribe, or been convicted or adjudged guilty of bribery or attempting to bribe, a public officer or employee of the City, the State of Illinois, or any agency of the federal government or of any state or local government in the United States of America, in that officer's or employee's official capacity;
- b. agreed or colluded with other bidders or prospective bidders, or been a party to any such agreement, or been convicted or adjudged guilty of agreement or collusion among bidders or prospective bidders, in restraint of freedom of competition by agreement to bid a fixed price or otherwise; or
- c. made an admission of such conduct described in a. or b. above that is a matter of record, but have not been prosecuted for such conduct; or
- d. violated the provisions of Municipal Code Section 2-92-610 (Living Wage Ordinance).

4. Neither the Disclosing Party, Affiliated Entity or Contractor, or any of their employees, officials, agents or partners, is barred from contracting with any unit of state or local government as a result of engaging in or being convicted of (1) bid-rigging in violation of 720 ILCS 5/33E-3; (2) bid-rotating in violation of 720 ILCS 5/33E-4; or (3) any similar offense of any state or of the United States of America that contains the same elements as the offense of bid-rigging or bid-rotating.

5. Neither the Disclosing Party nor any Affiliated Entity is listed on any of the following lists maintained by the Office of Foreign Assets Control of the U.S. Department of the Treasury or the Bureau of Industry and Security of the U.S. Department of Commerce or their successors: the Specially Designated Nationals List, the Denied Persons List, the Unverified List, the Entity List and the Debarred List.

6. The Disclosing Party understands and shall comply with the applicable requirements of Chapters 2-55 (Legislative Inspector General), 2-56 (Inspector General) and 2-156 (Governmental Ethics) of the Municipal Code.

7. If the Disclosing Party is unable to certify to any of the above statements in this Part B (Further Certifications), the Disclosing Party must explain below:

---

N/A

---

---

If the letters "NA," the word "None," or no response appears on the lines above, it will be conclusively presumed that the Disclosing Party certified to the above statements.

8. To the best of the Disclosing Party's knowledge after reasonable inquiry, the following is a complete list of all current employees of the Disclosing Party who were, at any time during the 12-month period preceding the execution date of this EDS, an employee, or elected or appointed official, of the City of Chicago (if none, indicate with "N/A" or "none").

---

---

---

9. To the best of the Disclosing Party's knowledge after reasonable inquiry, the following is a complete list of all gifts that the Disclosing Party has given or caused to be given, at any time during the 12-month period preceding the execution date of this EDS, to an employee, or elected or appointed official, of the City of Chicago. For purposes of this statement, a "gift" does not include: (i) anything made generally available to City employees or to the general public, or (ii) food or drink provided in the course of official City business and having a retail value of less than \$20 per recipient (if none, indicate with "N/A" or "none"). As to any gift listed below, please also list the name of the City recipient.

---

---

---

### C. CERTIFICATION OF STATUS AS FINANCIAL INSTITUTION

1. The Disclosing Party certifies that the Disclosing Party (check one)

is                       is not

a "financial institution" as defined in Section 2-32-455(b) of the Municipal Code.

2. If the Disclosing Party IS a financial institution, then the Disclosing Party pledges:

"We are not and will not become a predatory lender as defined in Chapter 2-32 of the Municipal Code. We further pledge that none of our affiliates is, and none of them will become, a predatory lender as defined in Chapter 2-32 of the Municipal Code. We understand that becoming a predatory lender or becoming an affiliate of a predatory lender may result in the loss of the privilege of doing business with the City."

If the Disclosing Party is unable to make this pledge because it or any of its affiliates (as defined in Section 2-32-455(b) of the Municipal Code) is a predatory lender within the meaning of Chapter 2-32 of the Municipal Code, explain here (attach additional pages if necessary):

---

---

---

If the letters "NA," the word "None," or no response appears on the lines above, it will be conclusively presumed that the Disclosing Party certified to the above statements.

**D. CERTIFICATION REGARDING INTEREST IN CITY BUSINESS**

Any words or terms that are defined in Chapter 2-156 of the Municipal Code have the same meanings when used in this Part D.

1. In accordance with Section 2-156-110 of the Municipal Code: Does any official or employee of the City have a financial interest in his or her own name or in the name of any other person or entity in the Matter?

Yes                       No

NOTE: If you checked "Yes" to Item D.1., proceed to Items D.2. and D.3. If you checked "No" to Item D.1., proceed to Part E.

2. Unless sold pursuant to a process of competitive bidding, or otherwise permitted, no City elected official or employee shall have a financial interest in his or her own name or in the name of any other person or entity in the purchase of any property that (i) belongs to the City, or (ii) is sold for taxes or assessments, or (iii) is sold by virtue of legal process at the suit of the City (collectively, "City Property Sale"). Compensation for property taken pursuant to the City's eminent domain power does not constitute a financial interest within the meaning of this Part D.

Does the Matter involve a City Property Sale?

Yes                       No

3. If you checked "Yes" to Item D.1., provide the names and business addresses of the City officials or employees having such interest and identify the nature of such interest:

Name	Business Address	Nature of Interest

4. The Disclosing Party further certifies that no prohibited financial interest in the Matter will be acquired by any City official or employee.

**E. CERTIFICATION REGARDING SLAVERY ERA BUSINESS**

Please check either 1. or 2. below. If the Disclosing Party checks 2., the Disclosing Party must disclose below or in an attachment to this EDS all information required by paragraph 2. Failure to

comply with these disclosure requirements may make any contract entered into with the City in connection with the Matter voidable by the City.

X 1. The Disclosing Party verifies that the Disclosing Party has searched any and all records of the Disclosing Party and any and all predecessor entities regarding records of investments or profits from slavery or slaveholder insurance policies during the slavery era (including insurance policies issued to slaveholders that provided coverage for damage to or injury or death of their slaves), and the Disclosing Party has found no such records.

\_\_\_\_ 2. The Disclosing Party verifies that, as a result of conducting the search in step 1 above, the Disclosing Party has found records of investments or profits from slavery or slaveholder insurance policies. The Disclosing Party verifies that the following constitutes full disclosure of all such records, including the names of any and all slaves or slaveholders described in those records:

---

---

---

---

## SECTION VI -- CERTIFICATIONS FOR FEDERALLY FUNDED MATTERS

**NOTE: If the Matter is federally funded**, complete this Section VI. **If the Matter is not federally funded**, proceed to Section VII. For purposes of this Section VI, tax credits allocated by the City and proceeds of debt obligations of the City are not federal funding.

### A. CERTIFICATION REGARDING LOBBYING

1. List below the names of all persons or entities registered under the federal Lobbying Disclosure Act of 1995 who have made lobbying contacts on behalf of the Disclosing Party with respect to the Matter: (Add sheets if necessary):

N/A

---

---

(If no explanation appears or begins on the lines above, or if the letters "NA" or if the word "None" appear, it will be conclusively presumed that the Disclosing Party means that NO persons or entities registered under the Lobbying Disclosure Act of 1995 have made lobbying contacts on behalf of the Disclosing Party with respect to the Matter.)

2. The Disclosing Party has not spent and will not expend any federally appropriated funds to pay any person or entity listed in Paragraph A.1. above for his or her lobbying activities or to pay any person or entity to influence or attempt to influence an officer or employee of any agency, as defined by applicable federal law, a member of Congress, an officer or employee of Congress, or an employee of a member of Congress, in connection with the award of any federally funded contract, making any federally funded grant or loan, entering into any cooperative agreement, or to extend, continue, renew, amend, or modify any federally funded contract, grant, loan, or cooperative agreement.

3. The Disclosing Party will submit an updated certification at the end of each calendar quarter in which there occurs any event that materially affects the accuracy of the statements and information set forth in paragraphs A.1. and A.2. above.

4. The Disclosing Party certifies that either: (i) it is not an organization described in section 501(c)(4) of the Internal Revenue Code of 1986; or (ii) it is an organization described in section 501(c)(4) of the Internal Revenue Code of 1986 but has not engaged and will not engage in "Lobbying Activities".

5. If the Disclosing Party is the Applicant, the Disclosing Party must obtain certifications equal in form and substance to paragraphs A.1. through A.4. above from all subcontractors before it awards any subcontract and the Disclosing Party must maintain all such subcontractors' certifications for the duration of the Matter and must make such certifications promptly available to the City upon request.

## B. CERTIFICATION REGARDING EQUAL EMPLOYMENT OPPORTUNITY

If the Matter is federally funded, federal regulations require the Applicant and all proposed subcontractors to submit the following information with their bids or in writing at the outset of negotiations.

Is the Disclosing Party the Applicant?

Yes                       No

If "Yes," answer the three questions below:

1. Have you developed and do you have on file affirmative action programs pursuant to applicable federal regulations? (See 41 CFR Part 60-2.)

Yes                       No

2. Have you filed with the Joint Reporting Committee, the Director of the Office of Federal Contract Compliance Programs, or the Equal Employment Opportunity Commission all reports due under the applicable filing requirements?

Yes                       No

3. Have you participated in any previous contracts or subcontracts subject to the equal opportunity clause?

Yes                       No

If you checked "No" to question 1. or 2. above, please provide an explanation:

---

---



## **SECTION VII -- ACKNOWLEDGMENTS, CONTRACT INCORPORATION, COMPLIANCE, PENALTIES, DISCLOSURE**

The Disclosing Party understands and agrees that:

A. The certifications, disclosures, and acknowledgments contained in this EDS will become part of any contract or other agreement between the Applicant and the City in connection with the Matter, whether procurement, City assistance, or other City action, and are material inducements to the City's execution of any contract or taking other action with respect to the Matter. The Disclosing Party understands that it must comply with all statutes, ordinances, and regulations on which this EDS is based.

B. The City's Governmental Ethics and Campaign Financing Ordinances, Chapters 2-156 and 2-164 of the Municipal Code, impose certain duties and obligations on persons or entities seeking City contracts, work, business, or transactions. The full text of these ordinances and a training program is available on line at [www.cityofchicago.org/Ethics](http://www.cityofchicago.org/Ethics), and may also be obtained from the City's Board of Ethics, 740 N.

Sedgwick St., Suite 500, Chicago, IL 60610, (312) 744-9660. The Disclosing Party must comply fully with the applicable ordinances.

C. If the City determines that any information provided in this EDS is false, incomplete or inaccurate, any contract or other agreement in connection with which it is submitted may be rescinded or be void or voidable, and the City may pursue any remedies under the contract or agreement (if not rescinded or void), at law, or in equity, including terminating the Disclosing Party's participation in the Matter and/or declining to allow the Disclosing Party to participate in other transactions with the City. Remedies at law for a false statement of material fact may include incarceration and an award to the City of treble damages.

D. It is the City's policy to make this document available to the public on its Internet site and/or upon request. Some or all of the information provided on this EDS and any attachments to this EDS may be made available to the public on the Internet, in response to a Freedom of Information Act request, or otherwise. By completing and signing this EDS, the Disclosing Party waives and releases any possible rights or claims which it may have against the City in connection with the public release of information contained in this EDS and also authorizes the City to verify the accuracy of any information submitted in this EDS.

E. The information provided in this EDS must be kept current. In the event of changes, the Disclosing Party must supplement this EDS up to the time the City takes action on the Matter. If the Matter is a contract being handled by the City's Department of Procurement Services, the Disclosing Party must update this EDS as the contract requires. **NOTE:** With respect to Matters subject to Article I of Chapter 1-23 of the Municipal Code (imposing **PERMANENT INELIGIBILITY** for certain specified offenses), the information provided herein regarding eligibility must be kept current for a longer period, as required by Chapter 1-23 and Section 2-154-020 of the Municipal Code.

The Disclosing Party represents and warrants that:

F.1. The Disclosing Party is not delinquent in the payment of any tax administered by the Illinois Department of Revenue, nor are the Disclosing Party or its Affiliated Entities delinquent in paying any fine, fee, tax or other charge owed to the City. This includes, but is not limited to, all water charges, sewer charges, license fees, parking tickets, property taxes or sales taxes.

F.2 If the Disclosing Party is the Applicant, the Disclosing Party and its Affiliated Entities will not use, nor permit their subcontractors to use, any facility listed by the U.S. E.P.A. on the federal Excluded Parties List System ("EPLS") maintained by the U. S. General Services Administration.

F.3 If the Disclosing Party is the Applicant, the Disclosing Party will obtain from any contractors/subcontractors hired or to be hired in connection with the Matter certifications equal in form and substance to those in F.1. and F.2. above and will not, without the prior written consent of the City, use any such contractor/subcontractor that does not provide such certifications or that the Disclosing Party has reason to believe has not provided or cannot provide truthful certifications.

NOTE: If the Disclosing Party cannot certify as to any of the items in F.1., F.2. or F.3. above, an explanatory statement must be attached to this EDS.

**CERTIFICATION**

Under penalty of perjury, the person signing below: (1) warrants that he/she is authorized to execute this EDS and Appendix A (if applicable) on behalf of the Disclosing Party, and (2) warrants that all certifications and statements contained in this EDS and Appendix A (if applicable) are true, accurate and complete as of the date furnished to the City.

NAGANATHAN GURU REVOCABLE TRUST

(Print or type name of Disclosing Party)

By: *Naganathan Guru*  
(Sign here)

NAGANATHAN GURU

(Print or type name of person signing)

TRUSTEE

(Print or type title of person signing)

Signed and sworn to before me on (date) 8/26/2013,  
at COOK County, ILLINOIS (state).

*Cecelia Johnson* Notary Public.

Commission expires: 1/23/2016.

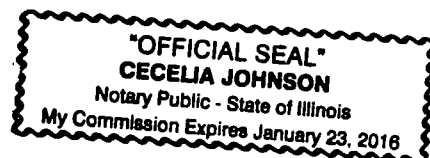

**CITY OF CHICAGO  
ECONOMIC DISCLOSURE STATEMENT AND AFFIDAVIT  
APPENDIX A**

**FAMILIAL RELATIONSHIPS WITH ELECTED CITY OFFICIALS AND DEPARTMENT HEADS**

**This Appendix is to be completed only by (a) the Applicant, and (b) any legal entity which has a direct ownership interest in the Applicant exceeding 7.5 percent. It is not to be completed by any legal entity which has only an indirect ownership interest in the Applicant.**

Under Municipal Code Section 2-154-015, the Disclosing Party must disclose whether such Disclosing Party or any “Applicable Party” or any Spouse or Domestic Partner thereof currently has a “familial relationship” with any elected city official or department head. A “familial relationship” exists if, as of the date this EDS is signed, the Disclosing Party or any “Applicable Party” or any Spouse or Domestic Partner thereof is related to the mayor, any alderman, the city clerk, the city treasurer or any city department head as spouse or domestic partner or as any of the following, whether by blood or adoption: parent, child, brother or sister, aunt or uncle, niece or nephew, grandparent, grandchild, father-in-law, mother-in-law, son-in-law, daughter-in-law, stepfather or stepmother, stepson or stepdaughter, stepbrother or stepsister or half-brother or half-sister.

“Applicable Party” means (1) all executive officers of the Disclosing Party listed in Section II.B.1.a., if the Disclosing Party is a corporation; all partners of the Disclosing Party, if the Disclosing Party is a general partnership; all general partners and limited partners of the Disclosing Party, if the Disclosing Party is a limited partnership; all managers, managing members and members of the Disclosing Party, if the Disclosing Party is a limited liability company; (2) all principal officers of the Disclosing Party; and (3) any person having more than a 7.5 percent ownership interest in the Disclosing Party. “Principal officers” means the president, chief operating officer, executive director, chief financial officer, treasurer or secretary of a legal entity or any person exercising similar authority.

Does the Disclosing Party or any “Applicable Party” or any Spouse or Domestic Partner thereof currently have a “familial relationship” with an elected city official or department head?

Yes

No

If yes, please identify below (1) the name and title of such person, (2) the name of the legal entity to which such person is connected; (3) the name and title of the elected city official or department head to whom such person has a familial relationship, and (4) the precise nature of such familial relationship.

---

---

---

**CITY OF CHICAGO  
ECONOMIC DISCLOSURE STATEMENT  
AND AFFIDAVIT**

**SECTION I -- GENERAL INFORMATION**

A. Legal name of the Disclosing Party submitting this EDS. Include d/b/a/ if applicable:

M.J. DUBIN REVOCABLE TRUST

**Check ONE of the following three boxes:**

Indicate whether the Disclosing Party submitting this EDS is:

1.  the Applicant

OR

2.  a legal entity holding a direct or indirect interest in the Applicant. State the legal name of the Applicant in which the Disclosing Party holds an interest: \_\_\_\_\_

OR

3.  a legal entity with a right of control (see Section II.B.1.) State the legal name of the entity in which the Disclosing Party holds a right of control: Nahshon Development, LLC

B. Business address of the Disclosing Party: \_\_\_\_\_

C. Telephone: \_\_\_\_\_ Email: \_\_\_\_\_

D. Name of contact person: MICHELLE DUBIN

E. Federal Employer Identification No. (if you have one): \_\_\_\_\_

F. Brief description of contract, transaction or other undertaking (referred to below as the "Matter") to which this EDS pertains. (Include project number and location of property, if applicable):

Planned Development Amendment for the property located at 3670-3688 & 3700-3738 North Milwaukee.

G. Which City agency or department is requesting this EDS? Dept. of Housing and Economic Development

If the Matter is a contract being handled by the City's Department of Procurement Services, please complete the following:

Specification # \_\_\_\_\_ and Contract # \_\_\_\_\_

**SECTION II -- DISCLOSURE OF OWNERSHIP INTERESTS**

**A. NATURE OF THE DISCLOSING PARTY**

1. Indicate the nature of the Disclosing Party:

- |   |  |
|---|--|
| <input type="checkbox"/> Person                                   | <input type="checkbox"/> Limited liability company       |
| <input type="checkbox"/> Publicly registered business corporation | <input type="checkbox"/> Limited liability partnership   |
| <input type="checkbox"/> Privately held business corporation      | <input type="checkbox"/> Joint venture                   |
| <input type="checkbox"/> Sole proprietorship                      | <input type="checkbox"/> Not-for-profit corporation      |
| <input type="checkbox"/> General partnership                      | (Is the not-for-profit corporation also a 501(c)(3))?    |
| <input type="checkbox"/> Limited partnership                      | <input type="checkbox"/> Yes <input type="checkbox"/> No |
| <input checked="" type="checkbox"/> Trust                         | <input type="checkbox"/> Other (please specify)          |
- 

2. For legal entities, the state (or foreign country) of incorporation or organization, if applicable:

ILLINOIS

3. For legal entities not organized in the State of Illinois: Has the organization registered to do business in the State of Illinois as a foreign entity?

- Yes  No  N/A

**B. IF THE DISCLOSING PARTY IS A LEGAL ENTITY:**

1. List below the full names and titles of all executive officers and all directors of the entity.

**NOTE:** For not-for-profit corporations, also list below all members, if any, which are legal entities. If there are no such members, write "no members." For trusts, estates or other similar entities, list below the legal titleholder(s).

If the entity is a general partnership, limited partnership, limited liability company, limited liability partnership or joint venture, list below the name and title of each general partner, managing member, manager or any other person or entity that controls the day-to-day management of the Disclosing Party.

**NOTE:** Each legal entity listed below must submit an EDS on its own behalf.

Name	Title
<u>Michelle Dubin</u>	<u>Trustee</u>

---

2. Please provide the following information concerning each person or entity having a direct or indirect beneficial interest (including ownership) in excess of 7.5% of the Disclosing Party. Examples of such an interest include shares in a corporation, partnership interest in a partnership or joint venture,

interest of a member or manager in a limited liability company, or interest of a beneficiary of a trust, estate or other similar entity. If none, state "None." **NOTE:** Pursuant to Section 2-154-030 of the Municipal Code of Chicago ("Municipal Code"), the City may require any such additional information from any applicant which is reasonably intended to achieve full disclosure.

Name	Business Address	Percentage Interest in the Disclosing Party
<u>Michelle Dubin</u>	<u>4252 N. Cicero Ave, Chicago IL</u>	<u>100%</u>

### **SECTION III -- BUSINESS RELATIONSHIPS WITH CITY ELECTED OFFICIALS**

Has the Disclosing Party had a "business relationship," as defined in Chapter 2-156 of the Municipal Code, with any City elected official in the 12 months before the date this EDS is signed?

Yes

No

If yes, please identify below the name(s) of such City elected official(s) and describe such relationship(s):

---

---

### **SECTION IV -- DISCLOSURE OF SUBCONTRACTORS AND OTHER RETAINED PARTIES**

The Disclosing Party must disclose the name and business address of each subcontractor, attorney, lobbyist, accountant, consultant and any other person or entity whom the Disclosing Party has retained or expects to retain in connection with the Matter, as well as the nature of the relationship, and the total amount of the fees paid or estimated to be paid. The Disclosing Party is not required to disclose employees who are paid solely through the Disclosing Party's regular payroll.

"Lobbyist" means any person or entity who undertakes to influence any legislative or administrative action on behalf of any person or entity other than: (1) a not-for-profit entity, on an unpaid basis, or (2) himself. "Lobbyist" also means any person or entity any part of whose duties as an employee of another includes undertaking to influence any legislative or administrative action.

If the Disclosing Party is uncertain whether a disclosure is required under this Section, the Disclosing Party must either ask the City whether disclosure is required or make the disclosure.

Name (indicate whether retained or anticipated to be retained)	Business Address	Relationship to Disclosing Party (subcontractor, attorney, lobbyist, etc.)	Fees (indicate whether paid or estimated.) <b>NOTE:</b> "hourly rate" or "t.b.d." is not an acceptable response.
--	------------------	--	--

---



---



---

(Add sheets if necessary)

[X] Check here if the Disclosing Party has not retained, nor expects to retain, any such persons or entities.

**SECTION V -- CERTIFICATIONS**

**A. COURT-ORDERED CHILD SUPPORT COMPLIANCE**

Under Municipal Code Section 2-92-415, substantial owners of business entities that contract with the City must remain in compliance with their child support obligations throughout the contract's term.

Has any person who directly or indirectly owns 10% or more of the Disclosing Party been declared in arrearage on any child support obligations by any Illinois court of competent jurisdiction?

Yes             No             No person directly or indirectly owns 10% or more of the Disclosing Party.

If "Yes," has the person entered into a court-approved agreement for payment of all support owed and is the person in compliance with that agreement?

Yes             No

**B. FURTHER CERTIFICATIONS**

1. Pursuant to Municipal Code Chapter 1-23, Article I ("Article I")(which the Applicant should consult for defined terms (e.g., "doing business") and legal requirements), if the Disclosing Party submitting this EDS is the Applicant and is doing business with the City, then the Disclosing Party certifies as follows: (i) neither the Applicant nor any controlling person is currently indicted or charged with, or has admitted guilt of, or has ever been convicted of, or placed under supervision for, any criminal offense involving actual, attempted, or conspiracy to commit bribery, theft, fraud, forgery, perjury, dishonesty or deceit against an officer or employee of the City or any sister agency; and (ii) the Applicant understands and acknowledges that compliance with Article I is a continuing requirement for doing business with the City. NOTE: If Article I applies to the Applicant, the permanent compliance timeframe in Article I supersedes some five-year compliance timeframes in certifications 2 and 3 below.

2. The Disclosing Party and, if the Disclosing Party is a legal entity, all of those persons or entities identified in Section II.B.1. of this EDS:

- a. are not presently debarred, suspended, proposed for debarment, declared ineligible or voluntarily excluded from any transactions by any federal, state or local unit of government;
- b. have not, within a five-year period preceding the date of this EDS, been convicted of a criminal offense, adjudged guilty, or had a civil judgment rendered against them in connection with: obtaining, attempting to obtain, or performing a public (federal, state or local) transaction or contract under a public transaction; a violation of federal or state antitrust statutes; fraud; embezzlement; theft; forgery; bribery; falsification or destruction of records; making false statements; or receiving stolen property;
- c. are not presently indicted for, or criminally or civilly charged by, a governmental entity (federal, state or local) with committing any of the offenses set forth in clause B.2.b. of this Section V;
- d. have not, within a five-year period preceding the date of this EDS, had one or more public transactions (federal, state or local) terminated for cause or default; and
- e. have not, within a five-year period preceding the date of this EDS, been convicted, adjudged guilty, or found liable in a civil proceeding, or in any criminal or civil action, including actions concerning environmental violations, instituted by the City or by the federal government, any state, or any other unit of local government.

3. The certifications in subparts 3, 4 and 5 concern:

- the Disclosing Party;
- any "Contractor" (meaning any contractor or subcontractor used by the Disclosing Party in connection with the Matter, including but not limited to all persons or legal entities disclosed under Section IV, "Disclosure of Subcontractors and Other Retained Parties");
- any "Affiliated Entity" (meaning a person or entity that, directly or indirectly: controls the Disclosing Party, is controlled by the Disclosing Party, or is, with the Disclosing Party, under common control of another person or entity. Indicia of control include, without limitation: interlocking management or ownership; identity of interests among family members, shared facilities and equipment; common use of employees; or organization of a business entity following the ineligibility of a business entity to do business with federal or state or local government, including the City, using substantially the same management, ownership, or principals as the ineligible entity); with respect to Contractors, the term Affiliated Entity means a person or entity that directly or indirectly controls the Contractor, is controlled by it, or, with the Contractor, is under common control of another person or entity;
- any responsible official of the Disclosing Party, any Contractor or any Affiliated Entity or any other official, agent or employee of the Disclosing Party, any Contractor or any Affiliated Entity, acting pursuant to the direction or authorization of a responsible official of the Disclosing Party, any Contractor or any Affiliated Entity (collectively "Agents").



Neither the Disclosing Party, nor any Contractor, nor any Affiliated Entity of either the Disclosing Party or any Contractor nor any Agents have, during the five years before the date this EDS is signed, or, with respect to a Contractor, an Affiliated Entity, or an Affiliated Entity of a Contractor during the five years before the date of such Contractor's or Affiliated Entity's contract or engagement in connection with the Matter:

- a. bribed or attempted to bribe, or been convicted or adjudged guilty of bribery or attempting to bribe, a public officer or employee of the City, the State of Illinois, or any agency of the federal government or of any state or local government in the United States of America, in that officer's or employee's official capacity;
- b. agreed or colluded with other bidders or prospective bidders, or been a party to any such agreement, or been convicted or adjudged guilty of agreement or collusion among bidders or prospective bidders, in restraint of freedom of competition by agreement to bid a fixed price or otherwise; or
- c. made an admission of such conduct described in a. or b. above that is a matter of record, but have not been prosecuted for such conduct; or
- d. violated the provisions of Municipal Code Section 2-92-610 (Living Wage Ordinance).

4. Neither the Disclosing Party, Affiliated Entity or Contractor, or any of their employees, officials, agents or partners, is barred from contracting with any unit of state or local government as a result of engaging in or being convicted of (1) bid-rigging in violation of 720 ILCS 5/33E-3; (2) bid-rotating in violation of 720 ILCS 5/33E-4; or (3) any similar offense of any state or of the United States of America that contains the same elements as the offense of bid-rigging or bid-rotating.

5. Neither the Disclosing Party nor any Affiliated Entity is listed on any of the following lists maintained by the Office of Foreign Assets Control of the U.S. Department of the Treasury or the Bureau of Industry and Security of the U.S. Department of Commerce or their successors: the Specially Designated Nationals List, the Denied Persons List, the Unverified List, the Entity List and the Debarred List.

6. The Disclosing Party understands and shall comply with the applicable requirements of Chapters 2-55 (Legislative Inspector General), 2-56 (Inspector General) and 2-156 (Governmental Ethics) of the Municipal Code.

7. If the Disclosing Party is unable to certify to any of the above statements in this Part B (Further Certifications), the Disclosing Party must explain below:

---

N/A

---

---

---

If the letters "NA," the word "None," or no response appears on the lines above, it will be conclusively presumed that the Disclosing Party certified to the above statements.

8. To the best of the Disclosing Party’s knowledge after reasonable inquiry, the following is a complete list of all current employees of the Disclosing Party who were, at any time during the 12-month period preceding the execution date of this EDS, an employee, or elected or appointed official, of the City of Chicago (if none, indicate with “N/A” or “none”).

---

---

---

9. To the best of the Disclosing Party’s knowledge after reasonable inquiry, the following is a complete list of all gifts that the Disclosing Party has given or caused to be given, at any time during the 12-month period preceding the execution date of this EDS, to an employee, or elected or appointed official, of the City of Chicago. For purposes of this statement, a “gift” does not include: (i) anything made generally available to City employees or to the general public, or (ii) food or drink provided in the course of official City business and having a retail value of less than \$20 per recipient (if none, indicate with “N/A” or “none”). As to any gift listed below, please also list the name of the City recipient.

---

---

---

C. CERTIFICATION OF STATUS AS FINANCIAL INSTITUTION

1. The Disclosing Party certifies that the Disclosing Party (check one)

is  is not

a "financial institution" as defined in Section 2-32-455(b) of the Municipal Code.

2. If the Disclosing Party IS a financial institution, then the Disclosing Party pledges:

"We are not and will not become a predatory lender as defined in Chapter 2-32 of the Municipal Code. We further pledge that none of our affiliates is, and none of them will become, a predatory lender as defined in Chapter 2-32 of the Municipal Code. We understand that becoming a predatory lender or becoming an affiliate of a predatory lender may result in the loss of the privilege of doing business with the City."

If the Disclosing Party is unable to make this pledge because it or any of its affiliates (as defined in Section 2-32-455(b) of the Municipal Code) is a predatory lender within the meaning of Chapter 2-32 of the Municipal Code, explain here (attach additional pages if necessary):

---

---

---

If the letters "NA," the word "None," or no response appears on the lines above, it will be conclusively presumed that the Disclosing Party certified to the above statements.

**D. CERTIFICATION REGARDING INTEREST IN CITY BUSINESS**

Any words or terms that are defined in Chapter 2-156 of the Municipal Code have the same meanings when used in this Part D.

1. In accordance with Section 2-156-110 of the Municipal Code: Does any official or employee of the City have a financial interest in his or her own name or in the name of any other person or entity in the Matter?

Yes                       No

NOTE: If you checked "Yes" to Item D.1., proceed to Items D.2. and D.3. If you checked "No" to Item D.1., proceed to Part E.

2. Unless sold pursuant to a process of competitive bidding, or otherwise permitted, no City elected official or employee shall have a financial interest in his or her own name or in the name of any other person or entity in the purchase of any property that (i) belongs to the City, or (ii) is sold for taxes or assessments, or (iii) is sold by virtue of legal process at the suit of the City (collectively, "City Property Sale"). Compensation for property taken pursuant to the City's eminent domain power does not constitute a financial interest within the meaning of this Part D.

Does the Matter involve a City Property Sale?

Yes                       No

3. If you checked "Yes" to Item D.1., provide the names and business addresses of the City officials or employees having such interest and identify the nature of such interest:

Name	Business Address	Nature of Interest
<hr/>		
<hr/>		
<hr/>		

4. The Disclosing Party further certifies that no prohibited financial interest in the Matter will be acquired by any City official or employee.

**E. CERTIFICATION REGARDING SLAVERY ERA BUSINESS**

Please check either 1. or 2. below. If the Disclosing Party checks 2., the Disclosing Party must disclose below or in an attachment to this EDS all information required by paragraph 2. Failure to

comply with these disclosure requirements may make any contract entered into with the City in connection with the Matter voidable by the City.

X 1. The Disclosing Party verifies that the Disclosing Party has searched any and all records of the Disclosing Party and any and all predecessor entities regarding records of investments or profits from slavery or slaveholder insurance policies during the slavery era (including insurance policies issued to slaveholders that provided coverage for damage to or injury or death of their slaves), and the Disclosing Party has found no such records.

\_\_\_\_ 2. The Disclosing Party verifies that, as a result of conducting the search in step 1 above, the Disclosing Party has found records of investments or profits from slavery or slaveholder insurance policies. The Disclosing Party verifies that the following constitutes full disclosure of all such records, including the names of any and all slaves or slaveholders described in those records:

---

---

---

---

**SECTION VI -- CERTIFICATIONS FOR FEDERALLY FUNDED MATTERS**

**NOTE: If the Matter is federally funded, complete this Section VI. If the Matter is not federally funded, proceed to Section VII. For purposes of this Section VI, tax credits allocated by the City and proceeds of debt obligations of the City are not federal funding.**

**A. CERTIFICATION REGARDING LOBBYING**

1. List below the names of all persons or entities registered under the federal Lobbying Disclosure Act of 1995 who have made lobbying contacts on behalf of the Disclosing Party with respect to the Matter: (Add sheets if necessary):

N/A

---

---

---

(If no explanation appears or begins on the lines above, or if the letters "NA" or if the word "None" appear, it will be conclusively presumed that the Disclosing Party means that NO persons or entities registered under the Lobbying Disclosure Act of 1995 have made lobbying contacts on behalf of the Disclosing Party with respect to the Matter.)

2. The Disclosing Party has not spent and will not expend any federally appropriated funds to pay any person or entity listed in Paragraph A.1. above for his or her lobbying activities or to pay any person or entity to influence or attempt to influence an officer or employee of any agency, as defined by applicable federal law, a member of Congress, an officer or employee of Congress, or an employee of a member of Congress, in connection with the award of any federally funded contract, making any federally funded grant or loan, entering into any cooperative agreement, or to extend, continue, renew, amend, or modify any federally funded contract, grant, loan, or cooperative agreement.

3. The Disclosing Party will submit an updated certification at the end of each calendar quarter in which there occurs any event that materially affects the accuracy of the statements and information set forth in paragraphs A.1. and A.2. above.

4. The Disclosing Party certifies that either: (i) it is not an organization described in section 501(c)(4) of the Internal Revenue Code of 1986; or (ii) it is an organization described in section 501(c)(4) of the Internal Revenue Code of 1986 but has not engaged and will not engage in "Lobbying Activities".

5. If the Disclosing Party is the Applicant, the Disclosing Party must obtain certifications equal in form and substance to paragraphs A.1. through A.4. above from all subcontractors before it awards any subcontract and the Disclosing Party must maintain all such subcontractors' certifications for the duration of the Matter and must make such certifications promptly available to the City upon request.

#### B. CERTIFICATION REGARDING EQUAL EMPLOYMENT OPPORTUNITY

If the Matter is federally funded, federal regulations require the Applicant and all proposed subcontractors to submit the following information with their bids or in writing at the outset of negotiations.

Is the Disclosing Party the Applicant?

Yes                       No

If "Yes," answer the three questions below:

1. Have you developed and do you have on file affirmative action programs pursuant to applicable federal regulations? (See 41 CFR Part 60-2.)

Yes                       No

2. Have you filed with the Joint Reporting Committee, the Director of the Office of Federal Contract Compliance Programs, or the Equal Employment Opportunity Commission all reports due under the applicable filing requirements?

Yes                       No

3. Have you participated in any previous contracts or subcontracts subject to the equal opportunity clause?

Yes                       No

If you checked "No" to question 1. or 2. above, please provide an explanation:

---

---

## **SECTION VII -- ACKNOWLEDGMENTS, CONTRACT INCORPORATION, COMPLIANCE, PENALTIES, DISCLOSURE**

The Disclosing Party understands and agrees that:

A. The certifications, disclosures, and acknowledgments contained in this EDS will become part of any contract or other agreement between the Applicant and the City in connection with the Matter, whether procurement, City assistance, or other City action, and are material inducements to the City's execution of any contract or taking other action with respect to the Matter. The Disclosing Party understands that it must comply with all statutes, ordinances, and regulations on which this EDS is based.

B. The City's Governmental Ethics and Campaign Financing Ordinances, Chapters 2-156 and 2-164 of the Municipal Code, impose certain duties and obligations on persons or entities seeking City contracts, work, business, or transactions. The full text of these ordinances and a training program is available on line at [www.cityofchicago.org/Ethics](http://www.cityofchicago.org/Ethics), and may also be obtained from the City's Board of Ethics, 740 N.

Sedgwick St., Suite 500, Chicago, IL 60610, (312) 744-9660. The Disclosing Party must comply fully with the applicable ordinances.

C. If the City determines that any information provided in this EDS is false, incomplete or inaccurate, any contract or other agreement in connection with which it is submitted may be rescinded or be void or voidable, and the City may pursue any remedies under the contract or agreement (if not rescinded or void), at law, or in equity, including terminating the Disclosing Party's participation in the Matter and/or declining to allow the Disclosing Party to participate in other transactions with the City. Remedies at law for a false statement of material fact may include incarceration and an award to the City of treble damages.

D. It is the City's policy to make this document available to the public on its Internet site and/or upon request. Some or all of the information provided on this EDS and any attachments to this EDS may be made available to the public on the Internet, in response to a Freedom of Information Act request, or otherwise. By completing and signing this EDS, the Disclosing Party waives and releases any possible rights or claims which it may have against the City in connection with the public release of information contained in this EDS and also authorizes the City to verify the accuracy of any information submitted in this EDS.

E. The information provided in this EDS must be kept current. In the event of changes, the Disclosing Party must supplement this EDS up to the time the City takes action on the Matter. If the Matter is a contract being handled by the City's Department of Procurement Services, the Disclosing Party must update this EDS as the contract requires. **NOTE:** With respect to Matters subject to Article I of Chapter 1-23 of the Municipal Code (imposing **PERMANENT INELIGIBILITY** for certain specified offenses), the information provided herein regarding eligibility must be kept current for a longer period, as required by Chapter 1-23 and Section 2-154-020 of the Municipal Code.

The Disclosing Party represents and warrants that:

F.1. The Disclosing Party is not delinquent in the payment of any tax administered by the Illinois Department of Revenue, nor are the Disclosing Party or its Affiliated Entities delinquent in paying any fine, fee, tax or other charge owed to the City. This includes, but is not limited to, all water charges, sewer charges, license fees, parking tickets, property taxes or sales taxes.

F.2 If the Disclosing Party is the Applicant, the Disclosing Party and its Affiliated Entities will not use, nor permit their subcontractors to use, any facility listed by the U.S. E.P.A. on the federal Excluded Parties List System ("EPLS") maintained by the U. S. General Services Administration.

F.3 If the Disclosing Party is the Applicant, the Disclosing Party will obtain from any contractors/subcontractors hired or to be hired in connection with the Matter certifications equal in form and substance to those in F.1. and F.2. above and will not, without the prior written consent of the City, use any such contractor/subcontractor that does not provide such certifications or that the Disclosing Party has reason to believe has not provided or cannot provide truthful certifications.

NOTE: If the Disclosing Party cannot certify as to any of the items in F.1., F.2. or F.3. above, an explanatory statement must be attached to this EDS.

**CERTIFICATION**

Under penalty of perjury, the person signing below: (1) warrants that he/she is authorized to execute this EDS and Appendix A (if applicable) on behalf of the Disclosing Party, and (2) warrants that all certifications and statements contained in this EDS and Appendix A (if applicable) are true, accurate and complete as of the date furnished to the City.

M.J. DUBIN REVOCABLE TRUST

(Print or type name of Disclosing Party)

By: *Michelle Dubin*  
(Sign here)

MICHELLE DUBIN

(Print or type name of person signing)

TRUSTEE

(Print or type title of person signing)

Signed and sworn to before me on (date) 08/22/2013,  
at LAKE County, IL (state).

*Naganathan Guru* Notary Public.

Commission expires: 11/02/15.

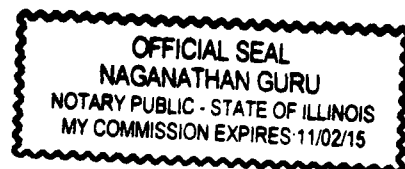

NOTARY PUBLIC - STATE OF CALIFORNIA  
MY COMMISSION EXPIRES 12/31/2018  
NAGAMATHAN GURU  
OFFICIAL SEAL



**CITY OF CHICAGO  
ECONOMIC DISCLOSURE STATEMENT AND AFFIDAVIT  
APPENDIX A**

**FAMILIAL RELATIONSHIPS WITH ELECTED CITY OFFICIALS AND DEPARTMENT HEADS**

**This Appendix is to be completed only by (a) the Applicant, and (b) any legal entity which has a direct ownership interest in the Applicant exceeding 7.5 percent. It is not to be completed by any legal entity which has only an indirect ownership interest in the Applicant.**

Under Municipal Code Section 2-154-015, the Disclosing Party must disclose whether such Disclosing Party or any “Applicable Party” or any Spouse or Domestic Partner thereof currently has a “familial relationship” with any elected city official or department head. A “familial relationship” exists if, as of the date this EDS is signed, the Disclosing Party or any “Applicable Party” or any Spouse or Domestic Partner thereof is related to the mayor, any alderman, the city clerk, the city treasurer or any city department head as spouse or domestic partner or as any of the following, whether by blood or adoption: parent, child, brother or sister, aunt or uncle, niece or nephew, grandparent, grandchild, father-in-law, mother-in-law, son-in-law, daughter-in-law, stepfather or stepmother, stepson or stepdaughter, stepbrother or stepsister or half-brother or half-sister.

“Applicable Party” means (1) all executive officers of the Disclosing Party listed in Section II.B.1.a., if the Disclosing Party is a corporation; all partners of the Disclosing Party, if the Disclosing Party is a general partnership; all general partners and limited partners of the Disclosing Party, if the Disclosing Party is a limited partnership; all managers, managing members and members of the Disclosing Party, if the Disclosing Party is a limited liability company; (2) all principal officers of the Disclosing Party; and (3) any person having more than a 7.5 percent ownership interest in the Disclosing Party. “Principal officers” means the president, chief operating officer, executive director, chief financial officer, treasurer or secretary of a legal entity or any person exercising similar authority.

Does the Disclosing Party or any “Applicable Party” or any Spouse or Domestic Partner thereof currently have a “familial relationship” with an elected city official or department head?

Yes

No

If yes, please identify below (1) the name and title of such person, (2) the name of the legal entity to which such person is connected; (3) the name and title of the elected city official or department head to whom such person has a familial relationship, and (4) the precise nature of such familial relationship.

---

---

---

**CITY OF CHICAGO  
ECONOMIC DISCLOSURE STATEMENT  
AND AFFIDAVIT**

**SECTION I -- GENERAL INFORMATION**

A. Legal name of the Disclosing Party submitting this EDS. Include d/b/a/ if applicable:  
3670-3720 NORTH MILWAUKEE,L.L.C.

**Check ONE of the following three boxes:**

Indicate whether the Disclosing Party submitting this EDS is:

1.  the Applicant  
OR

2.  a legal entity holding a direct or indirect interest in the Applicant. State the legal name of the Applicant in which the Disclosing Party holds an interest: \_\_\_\_\_ OR

3.  a legal entity with a right of control (see Section II.B.1.) State the legal name of the entity in which the Disclosing Party holds a right of control: Current property  
owner \_\_\_\_\_

B. Business address of the Disclosing Party: 4252 N CICERO AVE  
CHICAGO, IL 60641

C. Telephone: 773-427-2400 Fax: \_\_\_\_\_ Email: gurun@dubinresidential.com Name of contact person: Naganat Guru

E. Federal Employer Identification No. (if you have one): \_\_\_\_\_

F. Brief description of contract, transaction or other undertaking (referred to below as the "Matter") to which this EDS pertains. (Include project number and location of property, if applicable):

Planned Development Amendment for the property located at 3670-3688 & 3700-3738 North  
Milwaukee.

G. Which City agency or department is requesting this EDS? Dept. of Housing and Economic Development

If the Matter is a contract being handled by the City's Department of Procurement Services, please complete the following:

Specification # \_\_\_\_\_ and Contract # \_\_\_\_\_

**SECTION II -- DISCLOSURE OF OWNERSHIP INTERESTS**

**A. NATURE OF THE DISCLOSING PARTY**

1. Indicate the nature of the Disclosing Party:

- Person
- Publicly registered business corporation
- Privately held business corporation
- Sole proprietorship
- General partnership
- Limited partnership
- Trust
- Limited liability company
- Limited liability partnership
- Joint venture
- Not-for-profit corporation  
(Is the not-for-profit corporation also a 501(c)(3))?  
 Yes  No
- Other (please specify)

2. For legal entities, the state (or foreign country) of incorporation or organization, if applicable:

ILLINOIS

3. For legal entities not organized in the State of Illinois: Has the organization registered to do business in the State of Illinois as a foreign entity?

- Yes  No  N/A

**B. IF THE DISCLOSING PARTY IS A LEGAL ENTITY:**

1. List below the full names and titles of all executive officers and all directors of the entity.

**NOTE:** For not-for-profit corporations, also list below all members, if any, which are legal entities. If there are no such members, write "no members." For trusts, estates or other similar entities, list below the legal titleholder(s).

If the entity is a general partnership, limited partnership, limited liability company, limited liability partnership or joint venture, list below the name and title of each general partner, managing member, manager or any other person or entity that controls the day-to-day management of the Disclosing Party.

**NOTE:** Each legal entity listed below must submit an EDS on its own behalf.

Name	Title
3670-3720 North Milwaukee Properties Corp	Managing Member

2. Please provide the following information concerning each person or entity having a direct or indirect beneficial interest (including ownership) in excess of 7.5% of the Disclosing Party. Examples of such an interest include shares in a corporation, partnership interest in a partnership or joint venture,

interest of a member or manager in a limited liability company, or interest of a beneficiary of a trust, estate or other similar entity. If none, state "None." NOTE: Pursuant to Section 2-154-030 of the Municipal Code of Chicago ("Municipal Code"), the City may require any such additional information from any applicant which is reasonably intended to achieve full disclosure.

Name	Business Address	Percentage Interest in the Disclosing Party
<u>3670-3720 North</u> Milwaukee Properties Corp	4252 N. Cicero Ave, Chicago IL	100%

**SECTION III -- BUSINESS RELATIONSHIPS WITH CITY ELECTED OFFICIALS**

Has the Disclosing Party had a "business relationship," as defined in Chapter 2-156 of the Municipal Code, with any City elected official in the 12 months before the date this EDS is signed?

Yes                       No

If yes, please identify below the name(s) of such City elected official(s) and describe such relationship(s):

---

---

**SECTION IV -- DISCLOSURE OF SUBCONTRACTORS AND OTHER RETAINED PARTIES**

The Disclosing Party must disclose the name and business address of each subcontractor, attorney, lobbyist, accountant, consultant and any other person or entity whom the Disclosing Party has retained or expects to retain in connection with the Matter, as well as the nature of the relationship, and the total amount of the fees paid or estimated to be paid. The Disclosing Party is not required to disclose employees who are paid solely through the Disclosing Party's regular payroll.

“Lobbyist” means any person or entity who undertakes to influence any legislative or administrative action on behalf of any person or entity other than: (1) a not-for-profit entity, on an unpaid basis, or (2) himself. “Lobbyist” also means any person or entity any part of whose duties as an employee of another includes undertaking to influence any legislative or administrative action.

If the Disclosing Party is uncertain whether a disclosure is required under this Section, the Disclosing Party must either ask the City whether disclosure is required or make the disclosure.

Name (indicate whether retained or anticipated to be retained)	Business Address	Relationship to Disclosing Party (subcontractor, attorney, lobbyist, etc.)	Fees (indicate whether paid or estimated.) <b>NOTE:</b> "hourly rate" or "t.b.d." is not an acceptable response.
--	------------------	--	--

(Add sheets if necessary)

Check here if the Disclosing Party has not retained, nor expects to retain, any such persons or entities.

**SECTION V -- CERTIFICATIONS**

**A. COURT-ORDERED CHILD SUPPORT COMPLIANCE**

Under Municipal Code Section 2-92-415, substantial owners of business entities that contract with the City must remain in compliance with their child support obligations throughout the contract's term.

Has any person who directly or indirectly owns 10% or more of the Disclosing Party been declared in arrearage on any child support obligations by any Illinois court of competent jurisdiction?

Yes             No             No person directly or indirectly owns 10% or more of the Disclosing Party.

If "Yes," has the person entered into a court-approved agreement for payment of all support owed and is the person in compliance with that agreement?

Yes             No

**B. FURTHER CERTIFICATIONS**

1. Pursuant to Municipal Code Chapter 1-23, Article I ("Article I")(which the Applicant should consult for defined terms (e.g., "doing business") and legal requirements), if the Disclosing Party submitting this EDS is the Applicant and is doing business with the City, then the Disclosing Party certifies as follows: (i) neither the Applicant nor any controlling person is currently indicted or charged with, or has admitted guilt of, or has ever been convicted of, or placed under supervision for, any criminal offense involving actual, attempted, or conspiracy to commit bribery, theft, fraud, forgery, perjury, dishonesty or deceit against an officer or employee of the City or any sister agency; and (ii) the Applicant understands and acknowledges that compliance with Article I is a continuing requirement for doing business with the City. **NOTE:** If Article I applies to the Applicant, the permanent compliance timeframe in Article I supersedes some five-year compliance timeframes in certifications 2 and 3 below.

2. The Disclosing Party and, if the Disclosing Party is a legal entity, all of those persons or entities identified in Section II.B.1. of this EDS:

- a. are not presently debarred, suspended, proposed for debarment, declared ineligible or voluntarily excluded from any transactions by any federal, state or local unit of government;
- b. have not, within a five-year period preceding the date of this EDS, been convicted of a criminal offense, adjudged guilty, or had a civil judgment rendered against them in connection with: obtaining, attempting to obtain, or performing a public (federal, state or local) transaction or contract under a public transaction; a violation of federal or state antitrust statutes; fraud; embezzlement; theft; forgery; bribery; falsification or destruction of records; making false statements; or receiving stolen property;
- c. are not presently indicted for, or criminally or civilly charged by, a governmental entity (federal, state or local) with committing any of the offenses set forth in clause B.2.b. of this Section V;
- d. have not, within a five-year period preceding the date of this EDS, had one or more public transactions (federal, state or local) terminated for cause or default; and
- e. have not, within a five-year period preceding the date of this EDS, been convicted, adjudged guilty, or found liable in a civil proceeding, or in any criminal or civil action, including actions concerning environmental violations, instituted by the City or by the federal government, any state, or any other unit of local government.

3. The certifications in subparts 3, 4 and 5 concern:

- the Disclosing Party;
- any "Contractor" (meaning any contractor or subcontractor used by the Disclosing Party in connection with the Matter, including but not limited to all persons or legal entities disclosed under Section IV, "Disclosure of Subcontractors and Other Retained Parties");
- any "Affiliated Entity" (meaning a person or entity that, directly or indirectly: controls the Disclosing Party, is controlled by the Disclosing Party, or is, with the Disclosing Party, under common control of another person or entity. Indicia of control include, without limitation: interlocking management or ownership; identity of interests among family members, shared facilities and equipment; common use of employees; or organization of a business entity following the ineligibility of a business entity to do business with federal or state or local government, including the City, using substantially the same management, ownership, or principals as the ineligible entity); with respect to Contractors, the term Affiliated Entity means a person or entity that directly or indirectly controls the Contractor, is controlled by it, or, with the Contractor, is under common control of another person or entity;
- any responsible official of the Disclosing Party, any Contractor or any Affiliated Entity or any other official, agent or employee of the Disclosing Party, any Contractor or any Affiliated Entity, acting pursuant to the direction or authorization of a responsible official of the Disclosing Party, any Contractor or any Affiliated Entity (collectively "Agents").

Neither the Disclosing Party, nor any Contractor, nor any Affiliated Entity of either the Disclosing Party or any Contractor nor any Agents have, during the five years before the date this EDS is signed, or, with respect to a Contractor, an Affiliated Entity, or an Affiliated Entity of a Contractor during the five years before the date of such Contractor's or Affiliated Entity's contract or engagement in connection with the Matter:

- a. bribed or attempted to bribe, or been convicted or adjudged guilty of bribery or attempting to bribe, a public officer or employee of the City, the State of Illinois, or any agency of the federal government or of any state or local government in the United States of America, in that officer's or employee's official capacity;
- b. agreed or colluded with other bidders or prospective bidders, or been a party to any such agreement, or been convicted or adjudged guilty of agreement or collusion among bidders or prospective bidders, in restraint of freedom of competition by agreement to bid a fixed price or otherwise; or
- c. made an admission of such conduct described in a. or b. above that is a matter of record, but have not been prosecuted for such conduct; or
- d. violated the provisions of Municipal Code Section 2-92-610 (Living Wage Ordinance).

4. Neither the Disclosing Party, Affiliated Entity or Contractor, or any of their employees, officials, agents or partners, is barred from contracting with any unit of state or local government as a result of engaging in or being convicted of (1) bid-rigging in violation of 720 ILCS 5/33E-3; (2) bid-rotating in violation of 720 ILCS 5/33E-4; or (3) any similar offense of any state or of the United States of America that contains the same elements as the offense of bid-rigging or bid-rotating.

5. Neither the Disclosing Party nor any Affiliated Entity is listed on any of the following lists maintained by the Office of Foreign Assets Control of the U.S. Department of the Treasury or the Bureau of Industry and Security of the U.S. Department of Commerce or their successors: the Specially Designated Nationals List, the Denied Persons List, the Unverified List, the Entity List and the Debarred List.

6. The Disclosing Party understands and shall comply with the applicable requirements of Chapters 2-55 (Legislative Inspector General), 2-56 (Inspector General) and 2-156 (Governmental Ethics) of the Municipal Code.

7. If the Disclosing Party is unable to certify to any of the above statements in this Part B (Further Certifications), the Disclosing Party must explain below:

---

---

N/A

---

---

If the letters "NA," the word "None," or no response appears on the lines above, it will be conclusively presumed that the Disclosing Party certified to the above statements.

8. To the best of the Disclosing Party's knowledge after reasonable inquiry, the following is a complete list of all current employees of the Disclosing Party who were, at any time during the 12-month period preceding the execution date of this EDS, an employee, or elected or appointed official, of the City of Chicago (if none, indicate with "N/A" or "none").

---

---

---

9. To the best of the Disclosing Party's knowledge after reasonable inquiry, the following is a complete list of all gifts that the Disclosing Party has given or caused to be given, at any time during the 12-month period preceding the execution date of this EDS, to an employee, or elected or appointed official, of the City of Chicago. For purposes of this statement, a "gift" does not include: (i) anything made generally available to City employees or to the general public, or (ii) food or drink provided in the course of official City business and having a retail value of less than \$20 per recipient (if none, indicate with "N/A" or "none"). As to any gift listed below, please also list the name of the City recipient.

---

---

---

### C. CERTIFICATION OF STATUS AS FINANCIAL INSTITUTION

1. The Disclosing Party certifies that the Disclosing Party (check one).

is                       is not

a "financial institution" as defined in Section 2-32-455(b) of the Municipal Code.

2. If the Disclosing Party IS a financial institution, then the Disclosing Party pledges:

"We are not and will not become a predatory lender as defined in Chapter 2-32 of the Municipal Code. We further pledge that none of our affiliates is, and none of them will become, a predatory lender as defined in Chapter 2-32 of the Municipal Code. We understand that becoming a predatory lender or becoming an affiliate of a predatory lender may result in the loss of the privilege of doing business with the City."

If the Disclosing Party is unable to make this pledge because it or any of its affiliates (as defined in Section 2-32-455(b) of the Municipal Code) is a predatory lender within the meaning of Chapter 2-32 of the Municipal Code, explain here (attach additional pages if necessary):

---

---



---

If the letters "NA," the word "None," or no response appears on the lines above, it will be conclusively presumed that the Disclosing Party certified to the above statements.

**D. CERTIFICATION REGARDING INTEREST IN CITY BUSINESS**

Any words or terms that are defined in Chapter 2-156 of the Municipal Code have the same meanings when used in this Part D.

1. In accordance with Section 2-156-110 of the Municipal Code: Does any official or employee of the City have a financial interest in his or her own name or in the name of any other person or entity in the Matter?

Yes  No

NOTE: If you checked "Yes" to Item D.1., proceed to Items D.2. and D.3. If you checked "No" to Item D.1., proceed to Part E.

2. Unless sold pursuant to a process of competitive bidding, or otherwise permitted, no City elected official or employee shall have a financial interest in his or her own name or in the name of any other person or entity in the purchase of any property that (i) belongs to the City, or (ii) is sold for taxes or assessments, or (iii) is sold by virtue of legal process at the suit of the City (collectively, "City Property Sale"). Compensation for property taken pursuant to the City's eminent domain power does not constitute a financial interest within the meaning of this Part D.

Does the Matter involve a City Property Sale?

Yes  No

3. If you checked "Yes" to Item D.1., provide the names and business addresses of the City officials or employees having such interest and identify the nature of such interest:

Name	Business Address	Nature of Interest

4. The Disclosing Party further certifies that no prohibited financial interest in the Matter will be acquired by any City official or employee.

**E. CERTIFICATION REGARDING SLAVERY ERA BUSINESS**

Please check either 1. or 2. below. If the Disclosing Party checks 2., the Disclosing Party must disclose below or in an attachment to this EDS all information required by paragraph 2. Failure to

comply with these disclosure requirements may make any contract entered into with the City in connection with the Matter voidable by the City.

X 1. The Disclosing Party verifies that the Disclosing Party has searched any and all records of the Disclosing Party and any and all predecessor entities regarding records of investments or profits from slavery or slaveholder insurance policies during the slavery era (including insurance policies issued to slaveholders that provided coverage for damage to or injury or death of their slaves), and the Disclosing Party has found no such records.

\_\_\_ 2. The Disclosing Party verifies that, as a result of conducting the search in step 1 above, the Disclosing Party has found records of investments or profits from slavery or slaveholder insurance policies. The Disclosing Party verifies that the following constitutes full disclosure of all such records, including the names of any and all slaves or slaveholders described in those records:

---

---

---

---

**SECTION VI -- CERTIFICATIONS FOR FEDERALLY FUNDED MATTERS**

**NOTE: If the Matter is federally funded, complete this Section VI. If the Matter is not federally funded, proceed to Section VII. For purposes of this Section VI, tax credits allocated by the City and proceeds of debt obligations of the City are not federal funding.**

**A. CERTIFICATION REGARDING LOBBYING**

1. List below the names of all persons or entities registered under the federal Lobbying Disclosure Act of 1995 who have made lobbying contacts on behalf of the Disclosing Party with respect to the Matter: (Add sheets if necessary):

N/A

---

---

---

(If no explanation appears or begins on the lines above, or if the letters "NA" or if the word "None" appear, it will be conclusively presumed that the Disclosing Party means that NO persons or entities registered under the Lobbying Disclosure Act of 1995 have made lobbying contacts on behalf of the Disclosing Party with respect to the Matter.)

2. The Disclosing Party has not spent and will not expend any federally appropriated funds to pay any person or entity listed in Paragraph A.1. above for his or her lobbying activities or to pay any person or entity to influence or attempt to influence an officer or employee of any agency, as defined by applicable federal law, a member of Congress, an officer or employee of Congress, or an employee of a member of Congress, in connection with the award of any federally funded contract, making any federally funded grant or loan, entering into any cooperative agreement, or to extend, continue, renew, amend, or modify any federally funded contract, grant, loan, or cooperative agreement.

3. The Disclosing Party will submit an updated certification at the end of each calendar quarter in which there occurs any event that materially affects the accuracy of the statements and information set forth in paragraphs A.1. and A.2. above.

4. The Disclosing Party certifies that either: (i) it is not an organization described in section 501(c)(4) of the Internal Revenue Code of 1986; or (ii) it is an organization described in section 501(c)(4) of the Internal Revenue Code of 1986 but has not engaged and will not engage in "Lobbying Activities".

5. If the Disclosing Party is the Applicant, the Disclosing Party must obtain certifications equal in form and substance to paragraphs A.1. through A.4. above from all subcontractors before it awards any subcontract and the Disclosing Party must maintain all such subcontractors' certifications for the duration of the Matter and must make such certifications promptly available to the City upon request.

## B. CERTIFICATION REGARDING EQUAL EMPLOYMENT OPPORTUNITY

If the Matter is federally funded, federal regulations require the Applicant and all proposed subcontractors to submit the following information with their bids or in writing at the outset of negotiations.

Is the Disclosing Party the Applicant?

Yes                       No

If "Yes," answer the three questions below:

1. Have you developed and do you have on file affirmative action programs pursuant to applicable federal regulations? (See 41 CFR Part 60-2.)

Yes                       No

2. Have you filed with the Joint Reporting Committee, the Director of the Office of Federal Contract Compliance Programs, or the Equal Employment Opportunity Commission all reports due under the applicable filing requirements?

Yes                       No

3. Have you participated in any previous contracts or subcontracts subject to the equal opportunity clause?

Yes                       No

If you checked "No" to question 1. or 2. above, please provide an explanation:

---

---

## **SECTION VII -- ACKNOWLEDGMENTS, CONTRACT INCORPORATION, COMPLIANCE, PENALTIES, DISCLOSURE**

The Disclosing Party understands and agrees that:

A. The certifications, disclosures, and acknowledgments contained in this EDS will become part of any contract or other agreement between the Applicant and the City in connection with the Matter, whether procurement, City assistance, or other City action, and are material inducements to the City's execution of any contract or taking other action with respect to the Matter. The Disclosing Party understands that it must comply with all statutes, ordinances, and regulations on which this EDS is based.

B. The City's Governmental Ethics and Campaign Financing Ordinances, Chapters 2-156 and 2-164 of the Municipal Code, impose certain duties and obligations on persons or entities seeking City contracts, work, business, or transactions. The full text of these ordinances and a training program is available on line at [www.cityofchicago.org/Ethics](http://www.cityofchicago.org/Ethics), and may also be obtained from the City's Board of Ethics, 740 N.

Sedgwick St., Suite 500, Chicago, IL 60610, (312) 744-9660. The Disclosing Party must comply fully with the applicable ordinances.

C. If the City determines that any information provided in this EDS is false, incomplete or inaccurate, any contract or other agreement in connection with which it is submitted may be rescinded or be void or voidable, and the City may pursue any remedies under the contract or agreement (if not rescinded or void), at law, or in equity, including terminating the Disclosing Party's participation in the Matter and/or declining to allow the Disclosing Party to participate in other transactions with the City. Remedies at law for a false statement of material fact may include incarceration and an award to the City of treble damages.

D. It is the City's policy to make this document available to the public on its Internet site and/or upon request. Some or all of the information provided on this EDS and any attachments to this EDS may be made available to the public on the Internet, in response to a Freedom of Information Act request, or otherwise. By completing and signing this EDS, the Disclosing Party waives and releases any possible rights or claims which it may have against the City in connection with the public release of information contained in this EDS and also authorizes the City to verify the accuracy of any information submitted in this EDS.

E. The information provided in this EDS must be kept current. In the event of changes, the Disclosing Party must supplement this EDS up to the time the City takes action on the Matter. If the Matter is a contract being handled by the City's Department of Procurement Services, the Disclosing Party must update this EDS as the contract requires. **NOTE:** With respect to Matters subject to Article I of Chapter 1-23 of the Municipal Code (imposing **PERMANENT INELIGIBILITY** for certain specified offenses), the information provided herein regarding eligibility must be kept current for a longer period, as required by Chapter 1-23 and Section 2-154-020 of the Municipal Code.

The Disclosing Party represents and warrants that:

F.1. The Disclosing Party is not delinquent in the payment of any tax administered by the Illinois Department of Revenue, nor are the Disclosing Party or its Affiliated Entities delinquent in paying any fine, fee, tax or other charge owed to the City. This includes, but is not limited to, all water charges, sewer charges, license fees, parking tickets, property taxes or sales taxes.

F.2 If the Disclosing Party is the Applicant, the Disclosing Party and its Affiliated Entities will not use, nor permit their subcontractors to use, any facility listed by the U.S. E.P.A. on the federal Excluded Parties List System ("EPLS") maintained by the U. S. General Services Administration.

F.3 If the Disclosing Party is the Applicant, the Disclosing Party will obtain from any contractors/subcontractors hired or to be hired in connection with the Matter certifications equal in form and substance to those in F.1. and F.2. above and will not, without the prior written consent of the City, use any such contractor/subcontractor that does not provide such certifications or that the Disclosing Party has reason to believe has not provided or cannot provide truthful certifications.

NOTE: If the Disclosing Party cannot certify as to any of the items in F.1., F.2. or F.3. above, an explanatory statement must be attached to this EDS.

**CERTIFICATION**

Under penalty of perjury, the person signing below: (1) warrants that he/she is authorized to execute this EDS and Appendix A (if applicable) on behalf of the Disclosing Party, and (2) warrants that all certifications and statements contained in this EDS and Appendix A (if applicable) are true, accurate and complete as of the date furnished to the City.

3670-3720 North Milwaukee L.L.C.,  
(Print or type name of Disclosing Party)

By: \_\_\_\_\_  
(Sign here)

DAVID DUBIN  
(Print or type name of person signing)

President of 3670-3720 North Milwaukee Properties Corp, Managing Member of 3670-3720 North Milwaukee, LLC  
(Print or type title of person signing)

Signed and sworn to before me on (date) 08/26/2013,  
at LAKE County, IL (state).

Naganathan An Notary Public.

Commission expires: 11/02/15.

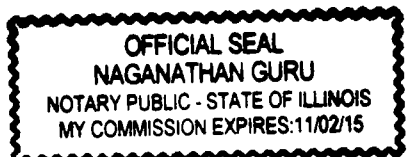

OFFICIAL SEAL  
NAGANATHAN GURU  
NOTARY PUBLIC STATE OF ILLINOIS  
MY COMMISSION EXPIRES 11/03/18

**CITY OF CHICAGO  
ECONOMIC DISCLOSURE STATEMENT AND AFFIDAVIT  
APPENDIX A**

**FAMILIAL RELATIONSHIPS WITH ELECTED CITY OFFICIALS AND DEPARTMENT HEADS**

**This Appendix is to be completed only by (a) the Applicant, and (b) any legal entity which has a direct ownership interest in the Applicant exceeding 7.5 percent. It is not to be completed by any legal entity which has only an indirect ownership interest in the Applicant.**

Under Municipal Code Section 2-154-015, the Disclosing Party must disclose whether such Disclosing Party or any “Applicable Party” or any Spouse or Domestic Partner thereof currently has a “familial relationship” with any elected city official or department head. A “familial relationship” exists if, as of the date this EDS is signed, the Disclosing Party or any “Applicable Party” or any Spouse or Domestic Partner thereof is related to the mayor, any alderman, the city clerk, the city treasurer or any city department head as spouse or domestic partner or as any of the following, whether by blood or adoption: parent, child, brother or sister, aunt or uncle, niece or nephew, grandparent, grandchild, father-in-law, mother-in-law, son-in-law, daughter-in-law, stepfather or stepmother, stepson or stepdaughter, stepbrother or stepsister or half-brother or half-sister.

“Applicable Party” means (1) all executive officers of the Disclosing Party listed in Section II.B.1.a., if the Disclosing Party is a corporation; all partners of the Disclosing Party, if the Disclosing Party is a general partnership; all general partners and limited partners of the Disclosing Party, if the Disclosing Party is a limited partnership; all managers, managing members and members of the Disclosing Party, if the Disclosing Party is a limited liability company; (2) all principal officers of the Disclosing Party; and (3) any person having more than a 7.5 percent ownership interest in the Disclosing Party. “Principal officers” means the president, chief operating officer, executive director, chief financial officer, treasurer or secretary of a legal entity or any person exercising similar authority.

Does the Disclosing Party or any “Applicable Party” or any Spouse or Domestic Partner thereof currently have a “familial relationship” with an elected city official or department head?

Yes

No

If yes, please identify below (1) the name and title of such person, (2) the name of the legal entity to which such person is connected; (3) the name and title of the elected city official or department head to whom such person has a familial relationship, and (4) the precise nature of such familial relationship.

---

---

---

**CITY OF CHICAGO  
ECONOMIC DISCLOSURE STATEMENT  
AND AFFIDAVIT**

**SECTION I -- GENERAL INFORMATION**

A. Legal name of the Disclosing Party submitting this EDS. Include d/b/a/ if applicable:  
3670-3720 North Milwaukee Properties Corp.

---

**Check ONE of the following three boxes:**

Indicate whether the Disclosing Party submitting this EDS is:

1.  the Applicant  
OR

2.  a legal entity holding a direct or indirect interest in the Applicant. State the legal name of the Applicant in which the Disclosing Party holds an interest: \_\_\_\_\_ OR

3.  a legal entity with a right of control (see Section II.B.1.) State the legal name of the entity in which the Disclosing Party holds a right of control: 3670-3720 North Milwaukee LLC.,

B. Business address of the Disclosing Party: 4252 N CICERO AVE  
CHICAGO, IL 60641

C. Telephone: 773-427-2400 Fax: \_\_\_\_\_ Email: gurun@dubinresidential.com Name of contact person: Naganat Guru

E. Federal Employer Identification No. (if you have one): \_\_\_\_\_

F. Brief description of contract, transaction or other undertaking (referred to below as the "Matter") to which this EDS pertains. (Include project number and location of property, if applicable):

Planned Development Amendment for the property located at 3670-3688 & 3700-3738 North Milwaukee.

G. Which City agency or department is requesting this EDS? Dept. of Housing and Economic Development

If the Matter is a contract being handled by the City's Department of Procurement Services, please complete the following:

Specification # \_\_\_\_\_ and Contract # \_\_\_\_\_



**SECTION II -- DISCLOSURE OF OWNERSHIP INTERESTS**

**A. NATURE OF THE DISCLOSING PARTY**

1. Indicate the nature of the Disclosing Party:

- Person
  - Publicly registered business corporation
  - Privately held business corporation
  - Sole proprietorship
  - General partnership
  - Limited partnership
  - Trust
  - Limited liability company
  - Limited liability partnership
  - Joint venture
  - Not-for-profit corporation
- (Is the not-for-profit corporation also a 501(c)(3))?
- Yes  No
- Other (please specify)
- 

2. For legal entities, the state (or foreign country) of incorporation or organization, if applicable:

ILLINOIS

3. For legal entities not organized in the State of Illinois: Has the organization registered to do business in the State of Illinois as a foreign entity?

- Yes
- No
- N/A

**B. IF THE DISCLOSING PARTY IS A LEGAL ENTITY:**

1. List below the full names and titles of all executive officers and all directors of the entity.

**NOTE:** For not-for-profit corporations, also list below all members, if any, which are legal entities. If there are no such members, write "no members." For trusts, estates or other similar entities, list below the legal titleholder(s).

If the entity is a general partnership, limited partnership, limited liability company, limited liability partnership or joint venture, list below the name and title of each general partner, managing member, manager or any other person or entity that controls the day-to-day management of the Disclosing Party.

**NOTE:** Each legal entity listed below must submit an EDS on its own behalf.

Name	Title
<u>David J. Dubin</u>	<u>President</u>

---



---



---

2. Please provide the following information concerning each person or entity having a direct or indirect beneficial interest (including ownership) in excess of 7.5% of the Disclosing Party. Examples of such an interest include shares in a corporation, partnership interest in a partnership or joint venture,

interest of a member or manager in a limited liability company, or interest of a beneficiary of a trust, estate or other similar entity. If none, state "None." **NOTE:** Pursuant to Section 2-154-030 of the Municipal Code of Chicago ("Municipal Code"), the City may require any such additional information from any applicant which is reasonably intended to achieve full disclosure.

Name	Business Address	Percentage Interest in the Disclosing Party
<u>David J. Dubin Revocable Trust</u>	<u>4252 N. Cicero Ave, Chicago IL</u>	<u>91%</u>
<u>Naganathan Guru Revocable Trust</u>	<u>4252 N. Cicero Ave, Chicago IL</u>	<u>9%</u>

### **SECTION III -- BUSINESS RELATIONSHIPS WITH CITY ELECTED OFFICIALS**

Has the Disclosing Party had a "business relationship," as defined in Chapter 2-156 of the Municipal Code, with any City elected official in the 12 months before the date this EDS is signed?

Yes                       No

If yes, please identify below the name(s) of such City elected official(s) and describe such relationship(s):

---

---

### **SECTION IV -- DISCLOSURE OF SUBCONTRACTORS AND OTHER RETAINED PARTIES**

The Disclosing Party must disclose the name and business address of each subcontractor, attorney, lobbyist, accountant, consultant and any other person or entity whom the Disclosing Party has retained or expects to retain in connection with the Matter, as well as the nature of the relationship, and the total amount of the fees paid or estimated to be paid. The Disclosing Party is not required to disclose employees who are paid solely through the Disclosing Party's regular payroll.

"Lobbyist" means any person or entity who undertakes to influence any legislative or administrative action on behalf of any person or entity other than: (1) a not-for-profit entity, on an unpaid basis, or (2) himself. "Lobbyist" also means any person or entity any part of whose duties as an employee of another includes undertaking to influence any legislative or administrative action.

If the Disclosing Party is uncertain whether a disclosure is required under this Section, the Disclosing Party must either ask the City whether disclosure is required or make the disclosure.

Name (indicate whether retained or anticipated to be retained)	Business Address	Relationship to Disclosing Party (subcontractor, attorney, lobbyist, etc.)	Fees (indicate whether paid or estimated.) <b>NOTE:</b> "hourly rate" or "t.b.d." is not an acceptable response.
--	------------------	--	--

---



---



---

(Add sheets if necessary)

Check here if the Disclosing Party has not retained, nor expects to retain, any such persons or entities.

**SECTION V -- CERTIFICATIONS**

**A. COURT-ORDERED CHILD SUPPORT COMPLIANCE**

Under Municipal Code Section 2-92-415, substantial owners of business entities that contract with the City must remain in compliance with their child support obligations throughout the contract's term.

Has any person who directly or indirectly owns 10% or more of the Disclosing Party been declared in arrearage on any child support obligations by any Illinois court of competent jurisdiction?

Yes             No             No person directly or indirectly owns 10% or more of the Disclosing Party.

If "Yes," has the person entered into a court-approved agreement for payment of all support owed and is the person in compliance with that agreement?

Yes             No

**B. FURTHER CERTIFICATIONS**

1. Pursuant to Municipal Code Chapter 1-23, Article I ("Article I")(which the Applicant should consult for defined terms (e.g., "doing business") and legal requirements), if the Disclosing Party submitting this EDS is the Applicant and is doing business with the City, then the Disclosing Party certifies as follows: (i) neither the Applicant nor any controlling person is currently indicted or charged with, or has admitted guilt of, or has ever been convicted of, or placed under supervision for, any criminal offense involving actual, attempted, or conspiracy to commit bribery, theft, fraud, forgery, perjury, dishonesty or deceit against an officer or employee of the City or any sister agency; and (ii) the Applicant understands and acknowledges that compliance with Article I is a continuing requirement for doing business with the City. **NOTE:** If Article I applies to the Applicant, the permanent compliance timeframe in Article I supersedes some five-year compliance timeframes in certifications 2 and 3 below.

2. The Disclosing Party and, if the Disclosing Party is a legal entity, all of those persons or entities identified in Section II.B.1. of this EDS:

- a. are not presently debarred, suspended, proposed for debarment, declared ineligible or voluntarily excluded from any transactions by any federal, state or local unit of government;
- b. have not, within a five-year period preceding the date of this EDS, been convicted of a criminal offense, adjudged guilty, or had a civil judgment rendered against them in connection with: obtaining, attempting to obtain, or performing a public (federal, state or local) transaction or contract under a public transaction; a violation of federal or state antitrust statutes; fraud; embezzlement; theft; forgery; bribery; falsification or destruction of records; making false statements; or receiving stolen property;
- c. are not presently indicted for, or criminally or civilly charged by, a governmental entity (federal, state or local) with committing any of the offenses set forth in clause B.2.b. of this Section V;
- d. have not, within a five-year period preceding the date of this EDS, had one or more public transactions (federal, state or local) terminated for cause or default; and
- e. have not, within a five-year period preceding the date of this EDS, been convicted, adjudged guilty, or found liable in a civil proceeding, or in any criminal or civil action, including actions concerning environmental violations, instituted by the City or by the federal government, any state, or any other unit of local government.

3. The certifications in subparts 3, 4 and 5 concern:

- the Disclosing Party;
- any "Contractor" (meaning any contractor or subcontractor used by the Disclosing Party in connection with the Matter, including but not limited to all persons or legal entities disclosed under Section IV, "Disclosure of Subcontractors and Other Retained Parties");
- any "Affiliated Entity" (meaning a person or entity that, directly or indirectly: controls the Disclosing Party, is controlled by the Disclosing Party, or is, with the Disclosing Party, under common control of another person or entity. Indicia of control include, without limitation: interlocking management or ownership; identity of interests among family members, shared facilities and equipment; common use of employees; or organization of a business entity following the ineligibility of a business entity to do business with federal or state or local government, including the City, using substantially the same management, ownership, or principals as the ineligible entity); with respect to Contractors, the term Affiliated Entity means a person or entity that directly or indirectly controls the Contractor, is controlled by it, or, with the Contractor, is under common control of another person or entity;
- any responsible official of the Disclosing Party, any Contractor or any Affiliated Entity or any other official, agent or employee of the Disclosing Party, any Contractor or any Affiliated Entity, acting pursuant to the direction or authorization of a responsible official of the Disclosing Party, any Contractor or any Affiliated Entity (collectively "Agents").

Neither the Disclosing Party, nor any Contractor, nor any Affiliated Entity of either the Disclosing Party or any Contractor nor any Agents have, during the five years before the date this EDS is signed, or, with respect to a Contractor, an Affiliated Entity, or an Affiliated Entity of a Contractor during the five years before the date of such Contractor's or Affiliated Entity's contract or engagement in connection with the Matter:

- a. bribed or attempted to bribe, or been convicted or adjudged guilty of bribery or attempting to bribe, a public officer or employee of the City, the State of Illinois, or any agency of the federal government or of any state or local government in the United States of America, in that officer's or employee's official capacity;
- b. agreed or colluded with other bidders or prospective bidders, or been a party to any such agreement, or been convicted or adjudged guilty of agreement or collusion among bidders or prospective bidders, in restraint of freedom of competition by agreement to bid a fixed price or otherwise; or
- c. made an admission of such conduct described in a. or b. above that is a matter of record, but have not been prosecuted for such conduct; or
- d. violated the provisions of Municipal Code Section 2-92-610 (Living Wage Ordinance).

4. Neither the Disclosing Party, Affiliated Entity or Contractor, or any of their employees, officials, agents or partners, is barred from contracting with any unit of state or local government as a result of engaging in or being convicted of (1) bid-rigging in violation of 720 ILCS 5/33E-3; (2) bid-rotating in violation of 720 ILCS 5/33E-4; or (3) any similar offense of any state or of the United States of America that contains the same elements as the offense of bid-rigging or bid-rotating.

5. Neither the Disclosing Party nor any Affiliated Entity is listed on any of the following lists maintained by the Office of Foreign Assets Control of the U.S. Department of the Treasury or the Bureau of Industry and Security of the U.S. Department of Commerce or their successors: the Specially Designated Nationals List, the Denied Persons List, the Unverified List, the Entity List and the Debarred List.

6. The Disclosing Party understands and shall comply with the applicable requirements of Chapters 2-55 (Legislative Inspector General), 2-56 (Inspector General) and 2-156 (Governmental Ethics) of the Municipal Code.

7. If the Disclosing Party is unable to certify to any of the above statements in this Part B (Further Certifications), the Disclosing Party must explain below:

---

N/A

---

---

---

If the letters "NA," the word "None," or no response appears on the lines above, it will be conclusively presumed that the Disclosing Party certified to the above statements.

8. To the best of the Disclosing Party's knowledge after reasonable inquiry, the following is a complete list of all current employees of the Disclosing Party who were, at any time during the 12-month period preceding the execution date of this EDS, an employee, or elected or appointed official, of the City of Chicago (if none, indicate with "N/A" or "none").

---

---

---

9. To the best of the Disclosing Party's knowledge after reasonable inquiry, the following is a complete list of all gifts that the Disclosing Party has given or caused to be given, at any time during the 12-month period preceding the execution date of this EDS, to an employee, or elected or appointed official, of the City of Chicago. For purposes of this statement, a "gift" does not include: (i) anything made generally available to City employees or to the general public, or (ii) food or drink provided in the course of official City business and having a retail value of less than \$20 per recipient (if none, indicate with "N/A" or "none"). As to any gift listed below, please also list the name of the City recipient.

---

---

---

### C. CERTIFICATION OF STATUS AS FINANCIAL INSTITUTION

1. The Disclosing Party certifies that the Disclosing Party (check one)

is                       is not

a "financial institution" as defined in Section 2-32-455(b) of the Municipal Code.

2. If the Disclosing Party IS a financial institution, then the Disclosing Party pledges:

"We are not and will not become a predatory lender as defined in Chapter 2-32 of the Municipal Code. We further pledge that none of our affiliates is, and none of them will become, a predatory lender as defined in Chapter 2-32 of the Municipal Code. We understand that becoming a predatory lender or becoming an affiliate of a predatory lender may result in the loss of the privilege of doing business with the City."

If the Disclosing Party is unable to make this pledge because it or any of its affiliates (as defined in Section 2-32-455(b) of the Municipal Code) is a predatory lender within the meaning of Chapter 2-32 of the Municipal Code, explain here (attach additional pages if necessary):

---

---

---

If the letters "NA," the word "None," or no response appears on the lines above, it will be conclusively presumed that the Disclosing Party certified to the above statements.

**D. CERTIFICATION REGARDING INTEREST IN CITY BUSINESS**

Any words or terms that are defined in Chapter 2-156 of the Municipal Code have the same meanings when used in this Part D.

1. In accordance with Section 2-156-110 of the Municipal Code: Does any official or employee of the City have a financial interest in his or her own name or in the name of any other person or entity in the Matter?

Yes                       No

NOTE: If you checked "Yes" to Item D.1., proceed to Items D.2. and D.3. If you checked "No" to Item D.1., proceed to Part E.

2. Unless sold pursuant to a process of competitive bidding, or otherwise permitted, no City elected official or employee shall have a financial interest in his or her own name or in the name of any other person or entity in the purchase of any property that (i) belongs to the City, or (ii) is sold for taxes or assessments, or (iii) is sold by virtue of legal process at the suit of the City (collectively, "City Property Sale"). Compensation for property taken pursuant to the City's eminent domain power does not constitute a financial interest within the meaning of this Part D.

Does the Matter involve a City Property Sale?

Yes                       No

3. If you checked "Yes" to Item D.1., provide the names and business addresses of the City officials or employees having such interest and identify the nature of such interest:

Name	Business Address	Nature of Interest
_____	_____	_____
_____	_____	_____
_____	_____	_____

4. The Disclosing Party further certifies that no prohibited financial interest in the Matter will be acquired by any City official or employee.

**E. CERTIFICATION REGARDING SLAVERY ERA BUSINESS**

Please check either 1. or 2. below. If the Disclosing Party checks 2., the Disclosing Party must disclose below or in an attachment to this EDS all information required by paragraph 2. Failure to

comply with these disclosure requirements may make any contract entered into with the City in connection with the Matter voidable by the City.

X 1. The Disclosing Party verifies that the Disclosing Party has searched any and all records of the Disclosing Party and any and all predecessor entities regarding records of investments or profits from slavery or slaveholder insurance policies during the slavery era (including insurance policies issued to slaveholders that provided coverage for damage to or injury or death of their slaves), and the Disclosing Party has found no such records.

\_\_\_\_ 2. The Disclosing Party verifies that, as a result of conducting the search in step 1 above, the Disclosing Party has found records of investments or profits from slavery or slaveholder insurance policies. The Disclosing Party verifies that the following constitutes full disclosure of all such records, including the names of any and all slaves or slaveholders described in those records:

---

---

---

---

**SECTION VI -- CERTIFICATIONS FOR FEDERALLY FUNDED MATTERS**

**NOTE: If the Matter is federally funded, complete this Section VI. If the Matter is not federally funded, proceed to Section VII. For purposes of this Section VI, tax credits allocated by the City and proceeds of debt obligations of the City are not federal funding.**

**A. CERTIFICATION REGARDING LOBBYING**

1. List below the names of all persons or entities registered under the federal Lobbying Disclosure Act of 1995 who have made lobbying contacts on behalf of the Disclosing Party with respect to the Matter: (Add sheets if necessary):

N/A

---

---

---

(If no explanation appears or begins on the lines above, or if the letters "NA" or if the word "None" appear, it will be conclusively presumed that the Disclosing Party means that NO persons or entities registered under the Lobbying Disclosure Act of 1995 have made lobbying contacts on behalf of the Disclosing Party with respect to the Matter.)

2. The Disclosing Party has not spent and will not expend any federally appropriated funds to pay any person or entity listed in Paragraph A.1. above for his or her lobbying activities or to pay any person or entity to influence or attempt to influence an officer or employee of any agency, as defined by applicable federal law, a member of Congress, an officer or employee of Congress, or an employee of a member of Congress, in connection with the award of any federally funded contract, making any federally funded grant or loan, entering into any cooperative agreement, or to extend, continue, renew, amend, or modify any federally funded contract, grant, loan, or cooperative agreement.



3. The Disclosing Party will submit an updated certification at the end of each calendar quarter in which there occurs any event that materially affects the accuracy of the statements and information set forth in paragraphs A.1. and A.2. above.

4. The Disclosing Party certifies that either: (i) it is not an organization described in section 501(c)(4) of the Internal Revenue Code of 1986; or (ii) it is an organization described in section 501(c)(4) of the Internal Revenue Code of 1986 but has not engaged and will not engage in "Lobbying Activities".

5. If the Disclosing Party is the Applicant, the Disclosing Party must obtain certifications equal in form and substance to paragraphs A.1. through A.4. above from all subcontractors before it awards any subcontract and the Disclosing Party must maintain all such subcontractors' certifications for the duration of the Matter and must make such certifications promptly available to the City upon request.

#### B. CERTIFICATION REGARDING EQUAL EMPLOYMENT OPPORTUNITY

If the Matter is federally funded, federal regulations require the Applicant and all proposed subcontractors to submit the following information with their bids or in writing at the outset of negotiations.

Is the Disclosing Party the Applicant?

Yes

No

If "Yes," answer the three questions below:

1. Have you developed and do you have on file affirmative action programs pursuant to applicable federal regulations? (See 41 CFR Part 60-2.)

Yes

No

2. Have you filed with the Joint Reporting Committee, the Director of the Office of Federal Contract Compliance Programs, or the Equal Employment Opportunity Commission all reports due under the applicable filing requirements?

Yes

No

3. Have you participated in any previous contracts or subcontracts subject to the equal opportunity clause?

Yes

No

If you checked "No" to question 1. or 2. above, please provide an explanation:

---

---

## **SECTION VII -- ACKNOWLEDGMENTS, CONTRACT INCORPORATION, COMPLIANCE, PENALTIES, DISCLOSURE**

The Disclosing Party understands and agrees that:

- A. The certifications, disclosures, and acknowledgments contained in this EDS will become part of any contract or other agreement between the Applicant and the City in connection with the Matter, whether procurement, City assistance, or other City action, and are material inducements to the City's execution of any contract or taking other action with respect to the Matter. The Disclosing Party understands that it must comply with all statutes, ordinances, and regulations on which this EDS is based.
- B. The City's Governmental Ethics and Campaign Financing Ordinances, Chapters 2-156 and 2-164 of the Municipal Code, impose certain duties and obligations on persons or entities seeking City contracts, work, business, or transactions. The full text of these ordinances and a training program is available on line at [www.cityofchicago.org/Ethics](http://www.cityofchicago.org/Ethics), and may also be obtained from the City's Board of Ethics, 740 N. Sedgwick St., Suite 500, Chicago, IL 60610, (312) 744-9660. The Disclosing Party must comply fully with the applicable ordinances.
- C. If the City determines that any information provided in this EDS is false, incomplete or inaccurate, any contract or other agreement in connection with which it is submitted may be rescinded or be void or voidable, and the City may pursue any remedies under the contract or agreement (if not rescinded or void), at law, or in equity, including terminating the Disclosing Party's participation in the Matter and/or declining to allow the Disclosing Party to participate in other transactions with the City. Remedies at law for a false statement of material fact may include incarceration and an award to the City of treble damages.
- D. It is the City's policy to make this document available to the public on its Internet site and/or upon request. Some or all of the information provided on this EDS and any attachments to this EDS may be made available to the public on the Internet, in response to a Freedom of Information Act request, or otherwise. By completing and signing this EDS, the Disclosing Party waives and releases any possible rights or claims which it may have against the City in connection with the public release of information contained in this EDS and also authorizes the City to verify the accuracy of any information submitted in this EDS.
- E. The information provided in this EDS must be kept current. In the event of changes, the Disclosing Party must supplement this EDS up to the time the City takes action on the Matter. If the Matter is a contract being handled by the City's Department of Procurement Services, the Disclosing Party must update this EDS as the contract requires. **NOTE:** With respect to Matters subject to Article I of Chapter 1-23 of the Municipal Code (imposing **PERMANENT INELIGIBILITY** for certain specified offenses), the information provided herein regarding eligibility must be kept current for a longer period, as required by Chapter 1-23 and Section 2-154-020 of the Municipal Code.

The Disclosing Party represents and warrants that:

F.1. The Disclosing Party is not delinquent in the payment of any tax administered by the Illinois Department of Revenue, nor are the Disclosing Party or its Affiliated Entities delinquent in paying any fine, fee, tax or other charge owed to the City. This includes, but is not limited to, all water charges, sewer charges, license fees, parking tickets, property taxes or sales taxes.

F.2 If the Disclosing Party is the Applicant, the Disclosing Party and its Affiliated Entities will not use, nor permit their subcontractors to use, any facility listed by the U.S. E.P.A. on the federal Excluded Parties List System ("EPLS") maintained by the U. S. General Services Administration.

F.3 If the Disclosing Party is the Applicant, the Disclosing Party will obtain from any contractors/subcontractors hired or to be hired in connection with the Matter certifications equal in form and substance to those in F.1. and F.2. above and will not, without the prior written consent of the City, use any such contractor/subcontractor that does not provide such certifications or that the Disclosing Party has reason to believe has not provided or cannot provide truthful certifications.

NOTE: If the Disclosing Party cannot certify as to any of the items in F.1., F.2. or F.3. above, an explanatory statement must be attached to this EDS.

**CERTIFICATION**

Under penalty of perjury, the person signing below: (1) warrants that he/she is authorized to execute this EDS and Appendix A (if applicable) on behalf of the Disclosing Party, and (2) warrants that all certifications and statements contained in this EDS and Appendix A (if applicable) are true, accurate and complete as of the date furnished to the City.

~~3670-3720 North Milwaukee Properties Corp.~~  
(Print or type name of Disclosing Party)

By: \_\_\_\_\_  
(Sign here)

DAVID DUBIN  
(Print or type name of person signing)

President  
(Print or type title of person signing)

Signed and sworn to before me on (date) 08/26/2013,  
at LAKE County, IL (state).

Naganathan G. An Notary Public.

Commission expires: 11/02/15.



OFFICIAL SEAL  
NAGANTHAN GURU  
NOTARY PUBLIC - STATE OF ILLINOIS  
MY COMMISSION EXPIRES 11/03/18

**CITY OF CHICAGO  
ECONOMIC DISCLOSURE STATEMENT AND AFFIDAVIT  
APPENDIX A .**

**FAMILIAL RELATIONSHIPS WITH ELECTED CITY OFFICIALS AND DEPARTMENT HEADS**

**This Appendix is to be completed only by (a) the Applicant, and (b) any legal entity which has a direct ownership interest in the Applicant exceeding 7.5 percent. It is not to be completed by any legal entity which has only an indirect ownership interest in the Applicant.**

Under Municipal Code Section 2-154-015, the Disclosing Party must disclose whether such Disclosing Party or any “Applicable Party” or any Spouse or Domestic Partner thereof currently has a “familial relationship” with any elected city official or department head. A “familial relationship” exists if, as of the date this EDS is signed, the Disclosing Party or any “Applicable Party” or any Spouse or Domestic Partner thereof is related to the mayor, any alderman, the city clerk, the city treasurer or any city department head as spouse or domestic partner or as any of the following, whether by blood or adoption: parent, child, brother or sister, aunt or uncle, niece or nephew, grandparent, grandchild, father-in-law, mother-in-law, son-in-law, daughter-in-law, stepfather or stepmother, stepson or stepdaughter, stepbrother or stepsister or half-brother or half-sister.

“Applicable Party” means (1) all executive officers of the Disclosing Party listed in Section II.B.1.a., if the Disclosing Party is a corporation; all partners of the Disclosing Party, if the Disclosing Party is a general partnership; all general partners and limited partners of the Disclosing Party, if the Disclosing Party is a limited partnership; all managers, managing members and members of the Disclosing Party, if the Disclosing Party is a limited liability company; (2) all principal officers of the Disclosing Party; and (3) any person having more than a 7.5 percent ownership interest in the Disclosing Party. “Principal officers” means the president, chief operating officer, executive director, chief financial officer, treasurer or secretary of a legal entity or any person exercising similar authority.

Does the Disclosing Party or any “Applicable Party” or any Spouse or Domestic Partner thereof currently have a “familial relationship” with an elected city official or department head?

Yes

No

If yes, please identify below (1) the name and title of such person, (2) the name of the legal entity to which such person is connected; (3) the name and title of the elected city official or department head to whom such person has a familial relationship, and (4) the precise nature of such familial relationship.

---

---

---

**CITY OF CHICAGO  
ECONOMIC DISCLOSURE STATEMENT  
AND AFFIDAVIT**

**SECTION I -- GENERAL INFORMATION**

A. Legal name of the Disclosing Party submitting this EDS. Include d/b/a/ if applicable:

DAVID J.DUBIN REVOCABLE TRUST

---

**Check ONE of the following three boxes:**

Indicate whether the Disclosing Party submitting this EDS is:

1.  the Applicant

OR

2.  a legal entity holding a direct or indirect interest in the Applicant. State the legal name of the Applicant in which the Disclosing Party holds an interest: \_\_\_\_\_

OR

3.  a legal entity with a right of control (see Section II.B.1.) State the legal name of the entity in which the Disclosing Party holds a right of control: 3670-3720 North Milwaukee Properties Corp.

B. Business address of the Disclosing Party: \_\_\_\_\_

C. Telephone \_\_\_\_\_ fax: \_\_\_\_\_ Em \_\_\_\_\_

D. Name of contact person: DAVID DUBIN

E. Federal Employer Identification No. (if you have one): \_\_\_\_\_

F. Brief description of contract, transaction or other undertaking (referred to below as the "Matter") to which this EDS pertains. (Include project number and location of property, if applicable):

Planned Development Amendment for the property located at 3670-3688 & 3700-3738 North Milwaukee.

G. Which City agency or department is requesting this EDS? Dept. of Housing and Economic Development

If the Matter is a contract being handled by the City's Department of Procurement Services, please complete the following:

Specification # \_\_\_\_\_ and Contract # \_\_\_\_\_

**SECTION II -- DISCLOSURE OF OWNERSHIP INTERESTS**

**A. NATURE OF THE DISCLOSING PARTY**

1. Indicate the nature of the Disclosing Party:

- |   |  |
|---|--|
| <input type="checkbox"/> Person                                   | <input type="checkbox"/> Limited liability company       |
| <input type="checkbox"/> Publicly registered business corporation | <input type="checkbox"/> Limited liability partnership   |
| <input type="checkbox"/> Privately held business corporation      | <input type="checkbox"/> Joint venture                   |
| <input type="checkbox"/> Sole proprietorship                      | <input type="checkbox"/> Not-for-profit corporation      |
| <input type="checkbox"/> General partnership                      | (Is the not-for-profit corporation also a 501(c)(3))?    |
| <input type="checkbox"/> Limited partnership                      | <input type="checkbox"/> Yes <input type="checkbox"/> No |
| <input checked="" type="checkbox"/> Trust                         | <input type="checkbox"/> Other (please specify)          |
- 

2. For legal entities, the state (or foreign country) of incorporation or organization, if applicable:

ILLINOIS

3. For legal entities not organized in the State of Illinois: Has the organization registered to do business in the State of Illinois as a foreign entity?

- Yes  No  N/A

**B. IF THE DISCLOSING PARTY IS A LEGAL ENTITY:**

1. List below the full names and titles of all executive officers and all directors of the entity.

**NOTE:** For not-for-profit corporations, also list below all members, if any, which are legal entities. If there are no such members, write "no members." For trusts, estates or other similar entities, list below the legal titleholder(s).

If the entity is a general partnership, limited partnership, limited liability company, limited liability partnership or joint venture, list below the name and title of each general partner, managing member, manager or any other person or entity that controls the day-to-day management of the Disclosing Party. **NOTE:** Each legal entity listed below must submit an EDS on its own behalf.

Name	Title
<u>David Dubin</u>	<u>Trustee</u>

---

2. Please provide the following information concerning each person or entity having a direct or indirect beneficial interest (including ownership) in excess of 7.5% of the Disclosing Party. Examples of such an interest include shares in a corporation, partnership interest in a partnership or joint venture,

interest of a member or manager in a limited liability company, or interest of a beneficiary of a trust, estate or other similar entity. If none, state "None." **NOTE:** Pursuant to Section 2-154-030 of the Municipal Code of Chicago ("Municipal Code"), the City may require any such additional information from any applicant which is reasonably intended to achieve full disclosure.

Name	Business Address	Percentage Interest in the Disclosing Party
David Dubin	4252 N. Cicero Ave, Chicago IL	100%

**SECTION III -- BUSINESS RELATIONSHIPS WITH CITY ELECTED OFFICIALS**

Has the Disclosing Party had a "business relationship," as defined in Chapter 2-156 of the Municipal Code, with any City elected official in the 12 months before the date this EDS is signed?

Yes                       No

If yes, please identify below the name(s) of such City elected official(s) and describe such relationship(s):

---

---

**SECTION IV -- DISCLOSURE OF SUBCONTRACTORS AND OTHER RETAINED PARTIES**

The Disclosing Party must disclose the name and business address of each subcontractor, attorney, lobbyist, accountant, consultant and any other person or entity whom the Disclosing Party has retained or expects to retain in connection with the Matter, as well as the nature of the relationship, and the total amount of the fees paid or estimated to be paid. The Disclosing Party is not required to disclose employees who are paid solely through the Disclosing Party's regular payroll.

“Lobbyist” means any person or entity who undertakes to influence any legislative or administrative action on behalf of any person or entity other than: (1) a not-for-profit entity, on an unpaid basis, or (2) himself. “Lobbyist” also means any person or entity any part of whose duties as an employee of another includes undertaking to influence any legislative or administrative action.

If the Disclosing Party is uncertain whether a disclosure is required under this Section, the Disclosing Party must either ask the City whether disclosure is required or make the disclosure.



Name (indicate whether retained or anticipated to be retained)	Business Address	Relationship to Disclosing Party (subcontractor, attorney, lobbyist, etc.)	Fees (indicate whether paid or estimated.) <b>NOTE:</b> "hourly rate" or "t.b.d." is not an acceptable response.
--	------------------	--	--

---



---



---

(Add sheets if necessary)

[X] Check here if the Disclosing Party has not retained, nor expects to retain, any such persons or entities.

**SECTION V -- CERTIFICATIONS**

**A. COURT-ORDERED CHILD SUPPORT COMPLIANCE**

Under Municipal Code Section 2-92-415, substantial owners of business entities that contract with the City must remain in compliance with their child support obligations throughout the contract's term.

Has any person who directly or indirectly owns 10% or more of the Disclosing Party been declared in arrearage on any child support obligations by any Illinois court of competent jurisdiction?

Yes       No       No person directly or indirectly owns 10% or more of the Disclosing Party.

If "Yes," has the person entered into a court-approved agreement for payment of all support owed and is the person in compliance with that agreement?

Yes       No

**B. FURTHER CERTIFICATIONS**

1. Pursuant to Municipal Code Chapter 1-23, Article I ("Article I")(which the Applicant should consult for defined terms (e.g., "doing business") and legal requirements), if the Disclosing Party submitting this EDS is the Applicant and is doing business with the City, then the Disclosing Party certifies as follows: (i) neither the Applicant nor any controlling person is currently indicted or charged with, or has admitted guilt of, or has ever been convicted of, or placed under supervision for, any criminal offense involving actual, attempted, or conspiracy to commit bribery, theft, fraud, forgery, perjury, dishonesty or deceit against an officer or employee of the City or any sister agency; and (ii) the Applicant understands and acknowledges that compliance with Article I is a continuing requirement for doing business with the City. **NOTE:** If Article I applies to the Applicant, the permanent compliance timeframe in Article I supersedes some five-year compliance timeframes in certifications 2 and 3 below.

2. The Disclosing Party and, if the Disclosing Party is a legal entity, all of those persons or entities identified in Section II.B.1. of this EDS:

- a. are not presently debarred, suspended, proposed for debarment, declared ineligible or voluntarily excluded from any transactions by any federal, state or local unit of government;
- b. have not, within a five-year period preceding the date of this EDS, been convicted of a criminal offense, adjudged guilty, or had a civil judgment rendered against them in connection with: obtaining, attempting to obtain, or performing a public (federal, state or local) transaction or contract under a public transaction; a violation of federal or state antitrust statutes; fraud; embezzlement; theft; forgery; bribery; falsification or destruction of records; making false statements; or receiving stolen property;
- c. are not presently indicted for, or criminally or civilly charged by, a governmental entity (federal, state or local) with committing any of the offenses set forth in clause B.2.b. of this Section V;
- d. have not, within a five-year period preceding the date of this EDS, had one or more public transactions (federal, state or local) terminated for cause or default; and
- e. have not, within a five-year period preceding the date of this EDS, been convicted, adjudged guilty, or found liable in a civil proceeding, or in any criminal or civil action, including actions concerning environmental violations, instituted by the City or by the federal government, any state, or any other unit of local government.

3. The certifications in subparts 3, 4 and 5 concern:

- the Disclosing Party;
- any "Contractor" (meaning any contractor or subcontractor used by the Disclosing Party in connection with the Matter, including but not limited to all persons or legal entities disclosed under Section IV, "Disclosure of Subcontractors and Other Retained Parties");
- any "Affiliated Entity" (meaning a person or entity that, directly or indirectly: controls the Disclosing Party, is controlled by the Disclosing Party, or is, with the Disclosing Party, under common control of another person or entity. Indicia of control include, without limitation: interlocking management or ownership; identity of interests among family members, shared facilities and equipment; common use of employees; or organization of a business entity following the ineligibility of a business entity to do business with federal or state or local government, including the City, using substantially the same management, ownership, or principals as the ineligible entity); with respect to Contractors, the term Affiliated Entity means a person or entity that directly or indirectly controls the Contractor, is controlled by it, or, with the Contractor, is under common control of another person or entity;
- any responsible official of the Disclosing Party, any Contractor or any Affiliated Entity or any other official, agent or employee of the Disclosing Party, any Contractor or any Affiliated Entity, acting pursuant to the direction or authorization of a responsible official of the Disclosing Party, any Contractor or any Affiliated Entity (collectively "Agents").

Neither the Disclosing Party, nor any Contractor, nor any Affiliated Entity of either the Disclosing Party or any Contractor nor any Agents have, during the five years before the date this EDS is signed, or, with respect to a Contractor, an Affiliated Entity, or an Affiliated Entity of a Contractor during the five years before the date of such Contractor's or Affiliated Entity's contract or engagement in connection with the Matter:

- a. bribed or attempted to bribe, or been convicted or adjudged guilty of bribery or attempting to bribe, a public officer or employee of the City, the State of Illinois, or any agency of the federal government or of any state or local government in the United States of America, in that officer's or employee's official capacity;
- b. agreed or colluded with other bidders or prospective bidders, or been a party to any such agreement, or been convicted or adjudged guilty of agreement or collusion among bidders or prospective bidders, in restraint of freedom of competition by agreement to bid a fixed price or otherwise; or
- c. made an admission of such conduct described in a. or b. above that is a matter of record, but have not been prosecuted for such conduct; or
- d. violated the provisions of Municipal Code Section 2-92-610 (Living Wage Ordinance).

4. Neither the Disclosing Party, Affiliated Entity or Contractor, or any of their employees, officials, agents or partners, is barred from contracting with any unit of state or local government as a result of engaging in or being convicted of (1) bid-rigging in violation of 720 ILCS 5/33E-3; (2) bid-rotating in violation of 720 ILCS 5/33E-4; or (3) any similar offense of any state or of the United States of America that contains the same elements as the offense of bid-rigging or bid-rotating.

5. Neither the Disclosing Party nor any Affiliated Entity is listed on any of the following lists maintained by the Office of Foreign Assets Control of the U.S. Department of the Treasury or the Bureau of Industry and Security of the U.S. Department of Commerce or their successors: the Specially Designated Nationals List, the Denied Persons List, the Unverified List, the Entity List and the Debarred List.

6. The Disclosing Party understands and shall comply with the applicable requirements of Chapters 2-55 (Legislative Inspector General), 2-56 (Inspector General) and 2-156 (Governmental Ethics) of the Municipal Code.

7. If the Disclosing Party is unable to certify to any of the above statements in this Part B (Further Certifications), the Disclosing Party must explain below:

---

---

N/A

---

---

If the letters "NA," the word "None," or no response appears on the lines above, it will be conclusively presumed that the Disclosing Party certified to the above statements.

8. To the best of the Disclosing Party's knowledge after reasonable inquiry, the following is a complete list of all current employees of the Disclosing Party who were, at any time during the 12-month period preceding the execution date of this EDS, an employee, or elected or appointed official, of the City of Chicago (if none, indicate with "N/A" or "none").

---

---

---

9. To the best of the Disclosing Party's knowledge after reasonable inquiry, the following is a complete list of all gifts that the Disclosing Party has given or caused to be given, at any time during the 12-month period preceding the execution date of this EDS, to an employee, or elected or appointed official, of the City of Chicago. For purposes of this statement, a "gift" does not include: (i) anything made generally available to City employees or to the general public, or (ii) food or drink provided in the course of official City business and having a retail value of less than \$20 per recipient (if none, indicate with "N/A" or "none"). As to any gift listed below, please also list the name of the City recipient.

---

---

---

### C. CERTIFICATION OF STATUS AS FINANCIAL INSTITUTION

1. The Disclosing Party certifies that the Disclosing Party (check one)

is                       is not

a "financial institution" as defined in Section 2-32-455(b) of the Municipal Code.

2. If the Disclosing Party IS a financial institution, then the Disclosing Party pledges:

"We are not and will not become a predatory lender as defined in Chapter 2-32 of the Municipal Code. We further pledge that none of our affiliates is, and none of them will become, a predatory lender as defined in Chapter 2-32 of the Municipal Code. We understand that becoming a predatory lender or becoming an affiliate of a predatory lender may result in the loss of the privilege of doing business with the City."

If the Disclosing Party is unable to make this pledge because it or any of its affiliates (as defined in Section 2-32-455(b) of the Municipal Code) is a predatory lender within the meaning of Chapter 2-32 of the Municipal Code, explain here (attach additional pages if necessary):

---

---

---

If the letters "NA," the word "None," or no response appears on the lines above, it will be conclusively presumed that the Disclosing Party certified to the above statements.

**D. CERTIFICATION REGARDING INTEREST IN CITY BUSINESS**

Any words or terms that are defined in Chapter 2-156 of the Municipal Code have the same meanings when used in this Part D.

1. In accordance with Section 2-156-110 of the Municipal Code: Does any official or employee of the City have a financial interest in his or her own name or in the name of any other person or entity in the Matter?

Yes                       No

NOTE: If you checked "Yes" to Item D.1., proceed to Items D.2. and D.3. If you checked "No" to Item D.1., proceed to Part E.

2. Unless sold pursuant to a process of competitive bidding, or otherwise permitted, no City elected official or employee shall have a financial interest in his or her own name or in the name of any other person or entity in the purchase of any property that (i) belongs to the City, or (ii) is sold for taxes or assessments, or (iii) is sold by virtue of legal process at the suit of the City (collectively, "City Property Sale"). Compensation for property taken pursuant to the City's eminent domain power does not constitute a financial interest within the meaning of this Part D.

Does the Matter involve a City Property Sale?

Yes                       No

3. If you checked "Yes" to Item D.1., provide the names and business addresses of the City officials or employees having such interest and identify the nature of such interest:

Name	Business Address	Nature of Interest

4. The Disclosing Party further certifies that no prohibited financial interest in the Matter will be acquired by any City official or employee.

**E. CERTIFICATION REGARDING SLAVERY ERA BUSINESS**

Please check either 1. or 2. below. If the Disclosing Party checks 2., the Disclosing Party must disclose below or in an attachment to this EDS all information required by paragraph 2. Failure to

comply with these disclosure requirements may make any contract entered into with the City in connection with the Matter voidable by the City.

X 1. The Disclosing Party verifies that the Disclosing Party has searched any and all records of the Disclosing Party and any and all predecessor entities regarding records of investments or profits from slavery or slaveholder insurance policies during the slavery era (including insurance policies issued to slaveholders that provided coverage for damage to or injury or death of their slaves), and the Disclosing Party has found no such records.

\_\_\_\_ 2. The Disclosing Party verifies that, as a result of conducting the search in step 1 above, the Disclosing Party has found records of investments or profits from slavery or slaveholder insurance policies. The Disclosing Party verifies that the following constitutes full disclosure of all such records, including the names of any and all slaves or slaveholders described in those records:

---

---

---

---

## SECTION VI -- CERTIFICATIONS FOR FEDERALLY FUNDED MATTERS

**NOTE: If the Matter is federally funded, complete this Section VI. If the Matter is not federally funded, proceed to Section VII. For purposes of this Section VI, tax credits allocated by the City and proceeds of debt obligations of the City are not federal funding.**

### A. CERTIFICATION REGARDING LOBBYING

1. List below the names of all persons or entities registered under the federal Lobbying Disclosure Act of 1995 who have made lobbying contacts on behalf of the Disclosing Party with respect to the Matter: (Add sheets if necessary):

N/A

---

---

(If no explanation appears or begins on the lines above, or if the letters "NA" or if the word "None" appear, it will be conclusively presumed that the Disclosing Party means that NO persons or entities registered under the Lobbying Disclosure Act of 1995 have made lobbying contacts on behalf of the Disclosing Party with respect to the Matter.)

2. The Disclosing Party has not spent and will not expend any federally appropriated funds to pay any person or entity listed in Paragraph A.1. above for his or her lobbying activities or to pay any person or entity to influence or attempt to influence an officer or employee of any agency, as defined by applicable federal law, a member of Congress, an officer or employee of Congress, or an employee of a member of Congress, in connection with the award of any federally funded contract, making any federally funded grant or loan, entering into any cooperative agreement, or to extend, continue, renew, amend, or modify any federally funded contract, grant, loan, or cooperative agreement.

3. The Disclosing Party will submit an updated certification at the end of each calendar quarter in which there occurs any event that materially affects the accuracy of the statements and information set forth in paragraphs A.1. and A.2. above.

4. The Disclosing Party certifies that either: (i) it is not an organization described in section 501(c)(4) of the Internal Revenue Code of 1986; or (ii) it is an organization described in section 501(c)(4) of the Internal Revenue Code of 1986 but has not engaged and will not engage in "Lobbying Activities".

5. If the Disclosing Party is the Applicant, the Disclosing Party must obtain certifications equal in form and substance to paragraphs A.1. through A.4. above from all subcontractors before it awards any subcontract and the Disclosing Party must maintain all such subcontractors' certifications for the duration of the Matter and must make such certifications promptly available to the City upon request.

#### B. CERTIFICATION REGARDING EQUAL EMPLOYMENT OPPORTUNITY

If the Matter is federally funded, federal regulations require the Applicant and all proposed subcontractors to submit the following information with their bids or in writing at the outset of negotiations.

Is the Disclosing Party the Applicant?

Yes  No

If "Yes," answer the three questions below:

1. Have you developed and do you have on file affirmative action programs pursuant to applicable federal regulations? (See 41 CFR Part 60-2.)

Yes  No

2. Have you filed with the Joint Reporting Committee, the Director of the Office of Federal Contract Compliance Programs, or the Equal Employment Opportunity Commission all reports due under the applicable filing requirements?

Yes  No

3. Have you participated in any previous contracts or subcontracts subject to the equal opportunity clause?

Yes  No

If you checked "No" to question 1. or 2. above, please provide an explanation:

---

---

## **SECTION VII -- ACKNOWLEDGMENTS, CONTRACT INCORPORATION, COMPLIANCE, PENALTIES, DISCLOSURE**

The Disclosing Party understands and agrees that:

A. The certifications, disclosures, and acknowledgments contained in this EDS will become part of any contract or other agreement between the Applicant and the City in connection with the Matter, whether procurement, City assistance, or other City action, and are material inducements to the City's execution of any contract or taking other action with respect to the Matter. The Disclosing Party understands that it must comply with all statutes, ordinances, and regulations on which this EDS is based.

B. The City's Governmental Ethics and Campaign Financing Ordinances, Chapters 2-156 and 2-164 of the Municipal Code, impose certain duties and obligations on persons or entities seeking City contracts, work, business, or transactions. The full text of these ordinances and a training program is available on line at [www.cityofchicago.org/Ethics](http://www.cityofchicago.org/Ethics), and may also be obtained from the City's Board of Ethics, 740 N.

Sedgwick St., Suite 500, Chicago, IL 60610, (312) 744-9660. The Disclosing Party must comply fully with the applicable ordinances.

C. If the City determines that any information provided in this EDS is false, incomplete or inaccurate, any contract or other agreement in connection with which it is submitted may be rescinded or be void or voidable, and the City may pursue any remedies under the contract or agreement (if not rescinded or void), at law, or in equity, including terminating the Disclosing Party's participation in the Matter and/or declining to allow the Disclosing Party to participate in other transactions with the City. Remedies at law for a false statement of material fact may include incarceration and an award to the City of treble damages.

D. It is the City's policy to make this document available to the public on its Internet site and/or upon request. Some or all of the information provided on this EDS and any attachments to this EDS may be made available to the public on the Internet, in response to a Freedom of Information Act request, or otherwise. By completing and signing this EDS, the Disclosing Party waives and releases any possible rights or claims which it may have against the City in connection with the public release of information contained in this EDS and also authorizes the City to verify the accuracy of any information submitted in this EDS.

E. The information provided in this EDS must be kept current. In the event of changes, the Disclosing Party must supplement this EDS up to the time the City takes action on the Matter. If the Matter is a contract being handled by the City's Department of Procurement Services, the Disclosing Party must update this EDS as the contract requires. **NOTE:** With respect to Matters subject to Article I of Chapter 1-23 of the Municipal Code (imposing **PERMANENT INELIGIBILITY** for certain specified offenses), the information provided herein regarding eligibility must be kept current for a longer period, as required by Chapter 1-23 and Section 2-154-020 of the Municipal Code.

The Disclosing Party represents and warrants that:



F.1. The Disclosing Party is not delinquent in the payment of any tax administered by the Illinois Department of Revenue, nor are the Disclosing Party or its Affiliated Entities delinquent in paying any fine, fee, tax or other charge owed to the City. This includes, but is not limited to, all water charges, sewer charges, license fees, parking tickets, property taxes or sales taxes.

F.2 If the Disclosing Party is the Applicant, the Disclosing Party and its Affiliated Entities will not use, nor permit their subcontractors to use, any facility listed by the U.S. E.P.A. on the federal Excluded Parties List System ("EPLS") maintained by the U. S. General Services Administration.

F.3 If the Disclosing Party is the Applicant, the Disclosing Party will obtain from any contractors/subcontractors hired or to be hired in connection with the Matter certifications equal in form and substance to those in F.1. and F.2. above and will not, without the prior written consent of the City, use any such contractor/subcontractor that does not provide such certifications or that the Disclosing Party has reason to believe has not provided or cannot provide truthful certifications.

NOTE: If the Disclosing Party cannot certify as to any of the items in F.1., F.2. or F.3. above, an explanatory statement must be attached to this EDS.

**CERTIFICATION**

Under penalty of perjury, the person signing below: (1) warrants that he/she is authorized to execute this EDS and Appendix A (if applicable) on behalf of the Disclosing Party, and (2) warrants that all certifications and statements contained in this EDS and Appendix A (if applicable) are true, accurate and complete as of the date furnished to the City.

DAVID J DUBIN REVOCABLE TRUST  
(Print or type name of Disclosing Party)

By: \_\_\_\_\_  
(Sign here)

DAVID DUBIN  
(Print or type name of person signing)

TRUSTEE  
(Print or type title of person signing)

Signed and sworn to before me on (date) 08/26/2013,  
at LAKE County, IL (state).

Naganathan Guru Notary Public.

Commission expires: 11/02/15.

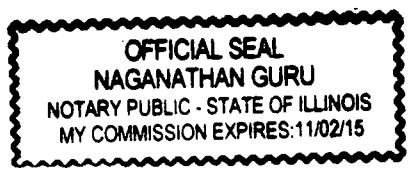

OFFICIAL SEAL  
NAGANATHAN GURU  
NOTARY PUBLIC STATE OF FLORIDA  
MY COMMISSION EXPIRES 11/03/16

**CITY OF CHICAGO  
ECONOMIC DISCLOSURE STATEMENT AND AFFIDAVIT  
APPENDIX A**

**FAMILIAL RELATIONSHIPS WITH ELECTED CITY OFFICIALS AND DEPARTMENT HEADS**

**This Appendix is to be completed only by (a) the Applicant, and (b) any legal entity which has a direct ownership interest in the Applicant exceeding 7.5 percent. It is not to be completed by any legal entity which has only an indirect ownership interest in the Applicant.**

Under Municipal Code Section 2-154-015, the Disclosing Party must disclose whether such Disclosing Party or any “Applicable Party” or any Spouse or Domestic Partner thereof currently has a “familial relationship” with any elected city official or department head. A “familial relationship” exists if, as of the date this EDS is signed, the Disclosing Party or any “Applicable Party” or any Spouse or Domestic Partner thereof is related to the mayor, any alderman, the city clerk, the city treasurer or any city department head as spouse or domestic partner or as any of the following, whether by blood or adoption: parent, child, brother or sister, aunt or uncle, niece or nephew, grandparent, grandchild, father-in-law, mother-in-law, son-in-law, daughter-in-law, stepfather or stepmother, stepson or stepdaughter, stepbrother or stepsister or half-brother or half-sister.

“Applicable Party” means (1) all executive officers of the Disclosing Party listed in Section II.B.1.a., if the Disclosing Party is a corporation; all partners of the Disclosing Party, if the Disclosing Party is a general partnership; all general partners and limited partners of the Disclosing Party, if the Disclosing Party is a limited partnership; all managers, managing members and members of the Disclosing Party, if the Disclosing Party is a limited liability company; (2) all principal officers of the Disclosing Party; and (3) any person having more than a 7.5 percent ownership interest in the Disclosing Party. “Principal officers” means the president, chief operating officer, executive director, chief financial officer, treasurer or secretary of a legal entity or any person exercising similar authority.

Does the Disclosing Party or any “Applicable Party” or any Spouse or Domestic Partner thereof currently have a “familial relationship” with an elected city official or department head?

Yes

No

If yes, please identify below (1) the name and title of such person, (2) the name of the legal entity to which such person is connected; (3) the name and title of the elected city official or department head to whom such person has a familial relationship, and (4) the precise nature of such familial relationship.

---

---

---

**CITY OF CHICAGO  
ECONOMIC DISCLOSURE STATEMENT  
AND AFFIDAVIT**

**SECTION I -- GENERAL INFORMATION**

A. Legal name of the Disclosing Party submitting this EDS. Include d/b/a/ if applicable:

NAGANATHAN GURU REVOCABLE TRUST

**Check ONE of the following three boxes:**

Indicate whether the Disclosing Party submitting this EDS is:

1.  the Applicant

OR

2.  a legal entity holding a direct or indirect interest in the Applicant. State the legal name of the Applicant in which the Disclosing Party holds an interest: \_\_\_\_\_

OR

3.  a legal entity with a right of control (see Section II.B.1.) State the legal name of the entity in which the Disclosing Party holds a right of control: 3670-3720 North Milwaukee Properties Corp.

B. Business address of the Disclosing Party: \_\_\_\_\_

C. Telephone: \_\_\_\_\_ FAX: \_\_\_\_\_ E \_\_\_\_\_

D. Name of contact person: Naganathan Guru

E. Federal Employer Identification No. (if you have one): \_\_\_\_\_

F. Brief description of contract, transaction or other undertaking (referred to below as the "Matter") to which this EDS pertains. (Include project number and location of property, if applicable):

Planned Development Amendment for the property located at 3670-3688 & 3700-3738 North Milwaukee.

G. Which City agency or department is requesting this EDS? Dept. of Housing and Economic Development

If the Matter is a contract being handled by the City's Department of Procurement Services, please complete the following:

Specification # \_\_\_\_\_ and Contract # \_\_\_\_\_

**SECTION II -- DISCLOSURE OF OWNERSHIP INTERESTS**

**A. NATURE OF THE DISCLOSING PARTY**

1. Indicate the nature of the Disclosing Party:

- Person
- Publicly registered business corporation
- Privately held business corporation
- Sole proprietorship
- General partnership
- Limited partnership
- Trust
- Limited liability company
- Limited liability partnership
- Joint venture
- Not-for-profit corporation  
(Is the not-for-profit corporation also a 501(c)(3))?  
 Yes  No
- Other (please specify)

2. For legal entities, the state (or foreign country) of incorporation or organization, if applicable:

ILLINOIS

3. For legal entities not organized in the State of Illinois: Has the organization registered to do business in the State of Illinois as a foreign entity?

- Yes  No  N/A

**B. IF THE DISCLOSING PARTY IS A LEGAL ENTITY:**

1. List below the full names and titles of all executive officers and all directors of the entity.

**NOTE:** For not-for-profit corporations, also list below all members, if any, which are legal entities. If there are no such members, write "no members." For trusts, estates or other similar entities, list below the legal titleholder(s).

If the entity is a general partnership, limited partnership, limited liability company, limited liability partnership or joint venture, list below the name and title of each general partner, managing member, manager or any other person or entity that controls the day-to-day management of the Disclosing Party.

**NOTE:** Each legal entity listed below must submit an EDS on its own behalf.

Name	Title
Naganathan Guru	Trustee

2. Please provide the following information concerning each person or entity having a direct or indirect beneficial interest (including ownership) in excess of 7.5% of the Disclosing Party. Examples of such an interest include shares in a corporation, partnership interest in a partnership or joint venture,

interest of a member or manager in a limited liability company, or interest of a beneficiary of a trust, estate or other similar entity. If none, state "None." **NOTE:** Pursuant to Section 2-154-030 of the Municipal Code of Chicago ("Municipal Code"), the City may require any such additional information from any applicant which is reasonably intended to achieve full disclosure.

Name	Business Address	Percentage Interest in the Disclosing Party
<u>Naganathan Guru</u>	<u>4252 N. Cicero Ave, Chicago IL</u>	<u>100%</u>

**SECTION III -- BUSINESS RELATIONSHIPS WITH CITY ELECTED OFFICIALS**

Has the Disclosing Party had a "business relationship," as defined in Chapter 2-156 of the Municipal Code, with any City elected official in the 12 months before the date this EDS is signed?

Yes                       No

If yes, please identify below the name(s) of such City elected official(s) and describe such relationship(s):

---

---

**SECTION IV -- DISCLOSURE OF SUBCONTRACTORS AND OTHER RETAINED PARTIES**

The Disclosing Party must disclose the name and business address of each subcontractor, attorney, lobbyist, accountant, consultant and any other person or entity whom the Disclosing Party has retained or expects to retain in connection with the Matter, as well as the nature of the relationship, and the total amount of the fees paid or estimated to be paid. The Disclosing Party is not required to disclose employees who are paid solely through the Disclosing Party's regular payroll.

“Lobbyist” means any person or entity who undertakes to influence any legislative or administrative action on behalf of any person or entity other than: (1) a not-for-profit entity, on an unpaid basis, or (2) himself. “Lobbyist” also means any person or entity any part of whose duties as an employee of another includes undertaking to influence any legislative or administrative action.

If the Disclosing Party is uncertain whether a disclosure is required under this Section, the Disclosing Party must either ask the City whether disclosure is required or make the disclosure.

Name (indicate whether retained or anticipated to be retained)	Business Address	Relationship to Disclosing Party (subcontractor, attorney, lobbyist, etc.)	Fees (indicate whether paid or estimated.) <b>NOTE:</b> "hourly rate" or "t.b.d." is not an acceptable response.
--	------------------	--	--

---



---



---

(Add sheets if necessary)

[X] Check here if the Disclosing Party has not retained, nor expects to retain, any such persons or entities.

**SECTION V -- CERTIFICATIONS**

**A. COURT-ORDERED CHILD SUPPORT COMPLIANCE**

Under Municipal Code Section 2-92-415, substantial owners of business entities that contract with the City must remain in compliance with their child support obligations throughout the contract's term.

Has any person who directly or indirectly owns 10% or more of the Disclosing Party been declared in arrearage on any child support obligations by any Illinois court of competent jurisdiction?

Yes       No       No person directly or indirectly owns 10% or more of the Disclosing Party.

If "Yes," has the person entered into a court-approved agreement for payment of all support owed and is the person in compliance with that agreement?

Yes       No

**B. FURTHER CERTIFICATIONS**

1. Pursuant to Municipal Code Chapter 1-23, Article I ("Article I")(which the Applicant should consult for defined terms (e.g., "doing business") and legal requirements), if the Disclosing Party submitting this EDS is the Applicant and is doing business with the City, then the Disclosing Party certifies as follows: (i) neither the Applicant nor any controlling person is currently indicted or charged with, or has admitted guilt of, or has ever been convicted of, or placed under supervision for, any criminal offense involving actual, attempted, or conspiracy to commit bribery, theft, fraud, forgery, perjury, dishonesty or deceit against an officer or employee of the City or any sister agency; and (ii) the Applicant understands and acknowledges that compliance with Article I is a continuing requirement for doing business with the City. **NOTE:** If Article I applies to the Applicant, the permanent compliance timeframe in Article I supersedes some five-year compliance timeframes in certifications 2 and 3 below.

2. The Disclosing Party and, if the Disclosing Party is a legal entity, all of those persons or entities identified in Section II.B.1. of this EDS:

- a. are not presently debarred, suspended, proposed for debarment, declared ineligible or voluntarily excluded from any transactions by any federal, state or local unit of government;
- b. have not, within a five-year period preceding the date of this EDS, been convicted of a criminal offense, adjudged guilty, or had a civil judgment rendered against them in connection with: obtaining, attempting to obtain, or performing a public (federal, state or local) transaction or contract under a public transaction; a violation of federal or state antitrust statutes; fraud; embezzlement; theft; forgery; bribery; falsification or destruction of records; making false statements; or receiving stolen property;
- c. are not presently indicted for, or criminally or civilly charged by, a governmental entity (federal, state or local) with committing any of the offenses set forth in clause B.2.b. of this Section V;
- d. have not, within a five-year period preceding the date of this EDS, had one or more public transactions (federal, state or local) terminated for cause or default; and
- e. have not, within a five-year period preceding the date of this EDS, been convicted, adjudged guilty, or found liable in a civil proceeding, or in any criminal or civil action, including actions concerning environmental violations, instituted by the City or by the federal government, any state, or any other unit of local government.

3. The certifications in subparts 3, 4 and 5 concern:

- the Disclosing Party;
- any "Contractor" (meaning any contractor or subcontractor used by the Disclosing Party in connection with the Matter, including but not limited to all persons or legal entities disclosed under Section IV, "Disclosure of Subcontractors and Other Retained Parties");
- any "Affiliated Entity" (meaning a person or entity that, directly or indirectly: controls the Disclosing Party, is controlled by the Disclosing Party, or is, with the Disclosing Party, under common control of another person or entity. Indicia of control include, without limitation: interlocking management or ownership; identity of interests among family members, shared facilities and equipment; common use of employees; or organization of a business entity following the ineligibility of a business entity to do business with federal or state or local government, including the City, using substantially the same management, ownership, or principals as the ineligible entity); with respect to Contractors, the term Affiliated Entity means a person or entity that directly or indirectly controls the Contractor, is controlled by it, or, with the Contractor, is under common control of another person or entity;
- any responsible official of the Disclosing Party, any Contractor or any Affiliated Entity or any other official, agent or employee of the Disclosing Party, any Contractor or any Affiliated Entity, acting pursuant to the direction or authorization of a responsible official of the Disclosing Party, any Contractor or any Affiliated Entity (collectively "Agents").



Neither the Disclosing Party, nor any Contractor, nor any Affiliated Entity of either the Disclosing Party or any Contractor nor any Agents have, during the five years before the date this EDS is signed, or, with respect to a Contractor, an Affiliated Entity, or an Affiliated Entity of a Contractor during the five years before the date of such Contractor's or Affiliated Entity's contract or engagement in connection with the Matter:

- a. bribed or attempted to bribe, or been convicted or adjudged guilty of bribery or attempting to bribe, a public officer or employee of the City, the State of Illinois, or any agency of the federal government or of any state or local government in the United States of America, in that officer's or employee's official capacity;
- b. agreed or colluded with other bidders or prospective bidders, or been a party to any such agreement, or been convicted or adjudged guilty of agreement or collusion among bidders or prospective bidders, in restraint of freedom of competition by agreement to bid a fixed price or otherwise; or
- c. made an admission of such conduct described in a. or b. above that is a matter of record, but have not been prosecuted for such conduct; or
- d. violated the provisions of Municipal Code Section 2-92-610 (Living Wage Ordinance).

4. Neither the Disclosing Party, Affiliated Entity or Contractor, or any of their employees, officials, agents or partners, is barred from contracting with any unit of state or local government as a result of engaging in or being convicted of (1) bid-rigging in violation of 720 ILCS 5/33E-3; (2) bid-rotating in violation of 720 ILCS 5/33E-4; or (3) any similar offense of any state or of the United States of America that contains the same elements as the offense of bid-rigging or bid-rotating.

5. Neither the Disclosing Party nor any Affiliated Entity is listed on any of the following lists maintained by the Office of Foreign Assets Control of the U.S. Department of the Treasury or the Bureau of Industry and Security of the U.S. Department of Commerce or their successors: the Specially Designated Nationals List, the Denied Persons List, the Unverified List, the Entity List and the Debarred List.

6. The Disclosing Party understands and shall comply with the applicable requirements of Chapters 2-55 (Legislative Inspector General), 2-56 (Inspector General) and 2-156 (Governmental Ethics) of the Municipal Code.

7. If the Disclosing Party is unable to certify to any of the above statements in this Part B (Further Certifications), the Disclosing Party must explain below:

---

N/A

---

---

If the letters "NA," the word "None," or no response appears on the lines above, it will be conclusively presumed that the Disclosing Party certified to the above statements.

8. To the best of the Disclosing Party's knowledge after reasonable inquiry, the following is a complete list of all current employees of the Disclosing Party who were, at any time during the 12-month period preceding the execution date of this EDS, an employee, or elected or appointed official, of the City of Chicago (if none, indicate with "N/A" or "none").

---

---

---

9. To the best of the Disclosing Party's knowledge after reasonable inquiry, the following is a complete list of all gifts that the Disclosing Party has given or caused to be given, at any time during the 12-month period preceding the execution date of this EDS, to an employee, or elected or appointed official, of the City of Chicago. For purposes of this statement, a "gift" does not include: (i) anything made generally available to City employees or to the general public, or (ii) food or drink provided in the course of official City business and having a retail value of less than \$20 per recipient (if none, indicate with "N/A" or "none"). As to any gift listed below, please also list the name of the City recipient.

---

---

---

### C. CERTIFICATION OF STATUS AS FINANCIAL INSTITUTION

1. The Disclosing Party certifies that the Disclosing Party (check one)

is                       is not

a "financial institution" as defined in Section 2-32-455(b) of the Municipal Code.

2. If the Disclosing Party IS a financial institution, then the Disclosing Party pledges:

"We are not and will not become a predatory lender as defined in Chapter 2-32 of the Municipal Code. We further pledge that none of our affiliates is, and none of them will become, a predatory lender as defined in Chapter 2-32 of the Municipal Code. We understand that becoming a predatory lender or becoming an affiliate of a predatory lender may result in the loss of the privilege of doing business with the City."

If the Disclosing Party is unable to make this pledge because it or any of its affiliates (as defined in Section 2-32-455(b) of the Municipal Code) is a predatory lender within the meaning of Chapter 2-32 of the Municipal Code, explain here (attach additional pages if necessary):

---

---

---

If the letters "NA," the word "None," or no response appears on the lines above, it will be conclusively presumed that the Disclosing Party certified to the above statements.

**D. CERTIFICATION REGARDING INTEREST IN CITY BUSINESS**

Any words or terms that are defined in Chapter 2-156 of the Municipal Code have the same meanings when used in this Part D.

1. In accordance with Section 2-156-110 of the Municipal Code: Does any official or employee of the City have a financial interest in his or her own name or in the name of any other person or entity in the Matter?

Yes                       No

NOTE: If you checked "Yes" to Item D.1., proceed to Items D.2. and D.3. If you checked "No" to Item D.1., proceed to Part E.

2. Unless sold pursuant to a process of competitive bidding, or otherwise permitted, no City elected official or employee shall have a financial interest in his or her own name or in the name of any other person or entity in the purchase of any property that (i) belongs to the City, or (ii) is sold for taxes or assessments, or (iii) is sold by virtue of legal process at the suit of the City (collectively, "City Property Sale"). Compensation for property taken pursuant to the City's eminent domain power does not constitute a financial interest within the meaning of this Part D.

Does the Matter involve a City Property Sale?

Yes                       No

3. If you checked "Yes" to Item D.1., provide the names and business addresses of the City officials or employees having such interest and identify the nature of such interest:

Name	Business Address	Nature of Interest
_____	_____	_____
_____	_____	_____
_____	_____	_____

4. The Disclosing Party further certifies that no prohibited financial interest in the Matter will be acquired by any City official or employee.

**E. CERTIFICATION REGARDING SLAVERY ERA BUSINESS**

Please check either 1. or 2. below. If the Disclosing Party checks 2., the Disclosing Party must disclose below or in an attachment to this EDS all information required by paragraph 2. Failure to

comply with these disclosure requirements may make any contract entered into with the City in connection with the Matter voidable by the City.

X 1. The Disclosing Party verifies that the Disclosing Party has searched any and all records of the Disclosing Party and any and all predecessor entities regarding records of investments or profits from slavery or slaveholder insurance policies during the slavery era (including insurance policies issued to slaveholders that provided coverage for damage to or injury or death of their slaves), and the Disclosing Party has found no such records.

\_\_\_ 2. The Disclosing Party verifies that, as a result of conducting the search in step 1 above, the Disclosing Party has found records of investments or profits from slavery or slaveholder insurance policies. The Disclosing Party verifies that the following constitutes full disclosure of all such records, including the names of any and all slaves or slaveholders described in those records:

---

---

---

---

## SECTION VI -- CERTIFICATIONS FOR FEDERALLY FUNDED MATTERS

**NOTE: If the Matter is federally funded, complete this Section VI. If the Matter is not federally funded, proceed to Section VII. For purposes of this Section VI, tax credits allocated by the City and proceeds of debt obligations of the City are not federal funding.**

### A. CERTIFICATION REGARDING LOBBYING

1. List below the names of all persons or entities registered under the federal Lobbying Disclosure Act of 1995 who have made lobbying contacts on behalf of the Disclosing Party with respect to the Matter: (Add sheets if necessary):

N/A

---

---

---

(If no explanation appears or begins on the lines above, or if the letters "NA" or if the word "None" appear, it will be conclusively presumed that the Disclosing Party means that NO persons or entities registered under the Lobbying Disclosure Act of 1995 have made lobbying contacts on behalf of the Disclosing Party with respect to the Matter.)

2. The Disclosing Party has not spent and will not expend any federally appropriated funds to pay any person or entity listed in Paragraph A.1. above for his or her lobbying activities or to pay any person or entity to influence or attempt to influence an officer or employee of any agency, as defined by applicable federal law, a member of Congress, an officer or employee of Congress, or an employee of a member of Congress, in connection with the award of any federally funded contract, making any federally funded grant or loan, entering into any cooperative agreement, or to extend, continue, renew, amend, or modify any federally funded contract, grant, loan, or cooperative agreement.

3. The Disclosing Party will submit an updated certification at the end of each calendar quarter in which there occurs any event that materially affects the accuracy of the statements and information set forth in paragraphs A.1. and A.2. above.

4. The Disclosing Party certifies that either: (i) it is not an organization described in section 501(c)(4) of the Internal Revenue Code of 1986; or (ii) it is an organization described in section 501(c)(4) of the Internal Revenue Code of 1986 but has not engaged and will not engage in "Lobbying Activities".

5. If the Disclosing Party is the Applicant, the Disclosing Party must obtain certifications equal in form and substance to paragraphs A.1. through A.4. above from all subcontractors before it awards any subcontract and the Disclosing Party must maintain all such subcontractors' certifications for the duration of the Matter and must make such certifications promptly available to the City upon request.

## B. CERTIFICATION REGARDING EQUAL EMPLOYMENT OPPORTUNITY

If the Matter is federally funded, federal regulations require the Applicant and all proposed subcontractors to submit the following information with their bids or in writing at the outset of negotiations.

Is the Disclosing Party the Applicant?

Yes

No

If "Yes," answer the three questions below:

1. Have you developed and do you have on file affirmative action programs pursuant to applicable federal regulations? (See 41 CFR Part 60-2.)

Yes

No

2. Have you filed with the Joint Reporting Committee, the Director of the Office of Federal Contract Compliance Programs, or the Equal Employment Opportunity Commission all reports due under the applicable filing requirements?

Yes

No

3. Have you participated in any previous contracts or subcontracts subject to the equal opportunity clause?

Yes

No

If you checked "No" to question 1. or 2. above, please provide an explanation:

---

---

## SECTION VII -- ACKNOWLEDGMENTS, CONTRACT INCORPORATION, COMPLIANCE, PENALTIES, DISCLOSURE

The Disclosing Party understands and agrees that:

A. The certifications, disclosures, and acknowledgments contained in this EDS will become part of any contract or other agreement between the Applicant and the City in connection with the Matter, whether procurement, City assistance, or other City action, and are material inducements to the City's execution of any contract or taking other action with respect to the Matter. The Disclosing Party understands that it must comply with all statutes, ordinances, and regulations on which this EDS is based.

B. The City's Governmental Ethics and Campaign Financing Ordinances, Chapters 2-156 and 2-164 of the Municipal Code, impose certain duties and obligations on persons or entities seeking City contracts, work, business, or transactions. The full text of these ordinances and a training program is available on line at [www.cityofchicago.org/Ethics](http://www.cityofchicago.org/Ethics), and may also be obtained from the City's Board of Ethics, 740 N.

Sedgwick St., Suite 500, Chicago, IL 60610, (312) 744-9660. The Disclosing Party must comply fully with the applicable ordinances.

C. If the City determines that any information provided in this EDS is false, incomplete or inaccurate, any contract or other agreement in connection with which it is submitted may be rescinded or be void or voidable, and the City may pursue any remedies under the contract or agreement (if not rescinded or void), at law, or in equity, including terminating the Disclosing Party's participation in the Matter and/or declining to allow the Disclosing Party to participate in other transactions with the City. Remedies at law for a false statement of material fact may include incarceration and an award to the City of treble damages.

D. It is the City's policy to make this document available to the public on its Internet site and/or upon request. Some or all of the information provided on this EDS and any attachments to this EDS may be made available to the public on the Internet, in response to a Freedom of Information Act request, or otherwise. By completing and signing this EDS, the Disclosing Party waives and releases any possible rights or claims which it may have against the City in connection with the public release of information contained in this EDS and also authorizes the City to verify the accuracy of any information submitted in this EDS.

E. The information provided in this EDS must be kept current. In the event of changes, the Disclosing Party must supplement this EDS up to the time the City takes action on the Matter. If the Matter is a contract being handled by the City's Department of Procurement Services, the Disclosing Party must update this EDS as the contract requires. **NOTE:** With respect to Matters subject to Article I of Chapter 1-23 of the Municipal Code (imposing **PERMANENT INELIGIBILITY** for certain specified offenses), the information provided herein regarding eligibility must be kept current for a longer period, as required by Chapter 1-23 and Section 2-154-020 of the Municipal Code.

The Disclosing Party represents and warrants that:

F.1. The Disclosing Party is not delinquent in the payment of any tax administered by the Illinois Department of Revenue, nor are the Disclosing Party or its Affiliated Entities delinquent in paying any fine, fee, tax or other charge owed to the City. This includes, but is not limited to, all water charges, sewer charges, license fees, parking tickets, property taxes or sales taxes.

F.2 If the Disclosing Party is the Applicant, the Disclosing Party and its Affiliated Entities will not use, nor permit their subcontractors to use, any facility listed by the U.S. E.P.A. on the federal Excluded Parties List System ("EPLS") maintained by the U. S. General Services Administration.

F.3 If the Disclosing Party is the Applicant, the Disclosing Party will obtain from any contractors/subcontractors hired or to be hired in connection with the Matter certifications equal in form and substance to those in F.1. and F.2. above and will not, without the prior written consent of the City, use any such contractor/subcontractor that does not provide such certifications or that the Disclosing Party has reason to believe has not provided or cannot provide truthful certifications.

NOTE: If the Disclosing Party cannot certify as to any of the items in F.1., F.2. or F.3. above, an explanatory statement must be attached to this EDS.

**CERTIFICATION**

Under penalty of perjury, the person signing below: (1) warrants that he/she is authorized to execute this EDS and Appendix A (if applicable) on behalf of the Disclosing Party, and (2) warrants that all certifications and statements contained in this EDS and Appendix A (if applicable) are true, accurate and complete as of the date furnished to the City.

NAGANATHAN GURU REVOCABLE TRUST

(Print or type name of Disclosing Party)

By: *Naganathan Guru*  
(Sign here)

NAGANATHAN GURU

(Print or type name of person signing)

TRUSTEE

(Print or type title of person signing)

Signed and sworn to before me on (date) 8/26/13,  
at COOK County, ILLINOIS (state).

*CJ* Notary Public.

Commission expires: 1/23/2016

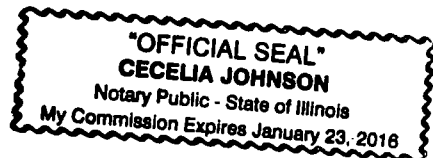





Residential Planned Development Number 1046, As Amended

Bulk Regulations And Data Table

Gross Site Area:	199,800 square feet (4.6 acres)
Net Site Area:	179,588 square feet (4.12 acres)
Maximum Floor Area Ratio:	1.0
Maximum Number of Residential Units:	50 Units
Maximum Site Coverage:	74%
Number of Off-Street Parking Spaces:	100 Minimum; 140 Maximum

Note: In the event fewer residential dwelling units are built, then fewer parking spaces may be built as long as the parking ration of 2.0 parking spaces per dwelling unit is maintained.

Minimum Building Setbacks:	Per Site Plan
Maximum Building Height:	35'-0"

Common Address of Property: 3670-3688 and 3700-3738 North Milwaukee,  
Chicago, Illinois

**STANDARD PLANNED DEVELOPMENT STATEMENTS  
FOR RESIDENTIAL PLANNED DEVELOPMENT NO. 1046, AS AMENDED**

1. The area delineated herein as Planned Development Number 1046, As Amended, (“Planned Development”) consists of approximately 199,800 square feet of property which is depicted on the attached Planned Development Boundary and Property Line Map (“Property”) and is owned or controlled by 3670-3720 North Milwaukee, LLC. The Applicant is Nahshon Development, LLC.
2. The requirements, obligations and conditions contained within this Planned Development shall be binding upon the Owner and the Applicant, their successors and assigns and, if different than the Owner and the Applicant, the legal title holders and any ground lessors. All rights granted hereunder to the Owner and the Applicant shall inure to the benefit of the Owner’s and Applicant’s successors and assigns and, if different than the Applicant, the legal title holder and any ground lessors. Furthermore, pursuant to the requirements of Section 17-8-0400 of the Chicago Zoning Ordinance, the Property, at the time of application for amendments, modifications or changes (administrative, legislative or otherwise) to this Planned Development are made, shall be under single ownership or designated control. Single designated control is defined in Section 17-8-0400 of the Zoning Ordinance. Single designated control for purposes of this paragraph shall mean that any application to the City for any amendment to this Planned Development shall be made by the Applicant, the owners of all property within the Planned Development or any homeowners association(s) formed to succeed the Owner and the Applicant for purposes of control and management of any portion of this Planned Development. No amendment may be sought without written approval by the homeowners association, once control has been turned over, unless the right to do so has been retained by Applicant and its successors on title documents. Notwithstanding the foregoing, the Owner and the Applicant shall retain the right to amend the Planned Development, or any portion thereof, until the Applicant, its successors or assigns, turns over control and management to the homeowners association.
3. All applicable official reviews, approvals or permits are required to be obtained by the Applicant or its successors, assignees or grantees. Any dedication or vacation of streets or alleys or grants of easements or any adjustment of the right-of-way shall require a separate submittal to the Department of Transportation on behalf of the Applicant or its successors, assign or grantees.

Any requests for grants of privilege, or any items encroaching on the public way, shall be in compliance with the Plans.

Ingress or egress shall be pursuant to the Plans and may be subject to the review and approval of the Departments of Housing and Economic Development and Transportation. Closure of all or any public street or alley during demolition or construction shall be subject to the review and approval of the Department of Transportation.

Applicant.	Nahshon Development, LLC
Address.	3670-3688 and 3700-3738 North Milwaukee, Chicago, Illinois
Introduced:	September 11, 2013
Plan Commission:	TBD

All work proposed in the public way must be designed and constructed in accordance with the Department of Transportation Construction Standards for Work in the Public Way and in compliance with the Municipal Code of the City of Chicago. Prior to the issuance of any Part II approval, the submitted plans must be approved by the Department of Transportation.

4. This Plan of Development consists of 14 Statements and the following prepared by Pappageorge Haymes, Ltd. and dated September 11, 2013 submitted herein:

- a Bulk Regulations Table;
- an Existing Zoning Map;
- an Existing Land-Use Map;
- a Planned Development Boundary and Property Line Map;
- Site Plan-Larger Home and Site Plan-Typical Home;
- Site Landscape Plan and Lot Landscape Plan;
- Milwaukee Street Elevations, Typical Side and Rear Elevations, Front Elevations Options, and “L” Floor Plan Elevation;
- Corner Lot Porch Options, Typically Home Porch Options, and Optional Full Width Porch on Typical Lot.

The Department of Housing and Economic Development acknowledges and agrees that the Applicant may apply for building permits showing optional features, including, but not limited to, a three car garage, front and rear porches, rear decks, chimneys, a bonus room, a larger or smaller footprint as shown on the Site Plan-Larger Home and Site Plan-Typical Home, finished basements, and any other features allowed to encroach into the required setbacks pursuant to Section 17-17-0309 of the Zoning Ordinance without requiring a Minor Change to this Planned Development.

Full-sized copies of the Site Plan-Larger Home Option and Site Plan-Typical Home; Site Landscape Plan and Lot Landscape Plan; Milwaukee Street Elevations, Typical Side and Rear Elevations, Front Elevations Options, and “L” Floor Plan Elevation are on file with the Department of Housing and Economic Development. In any instance where a provision of this Planned Development conflicts with the Chicago Building Code, the Building Code shall control. This Planned Development conforms to the intent and purpose of the Zoning Ordinance, and all requirements thereto, and satisfies the established criteria for approval as a Planned Development. In case of a conflict between the terms of this Planned Development Ordinance and the Zoning Ordinance, this Planned Development Ordinance shall control.

5. The following uses are permitted in the area delineated herein as 1046 Planned Development, As Amended: single family detached dwelling units; accessory parking; and related uses.

6. On-Premise signs and temporary signs, such as construction and marketing signs, shall be permitted within the Planned Development, subject to the review and approval of the Department of Housing and Economic Development. Off-Premise signs are prohibited within the boundary of the Planned Development.

Applicant:	Nahshon Development, LLC
Address:	3670-3688 and 3700-3738 North Milwaukee, Chicago, Illinois
Introduced:	September 11, 2013
Plan Commission:	TBD

7. For purposes of height measurement, the definitions in the Zoning Ordinance shall apply. The height of any building shall also be subject to height limitations, if any, established by the Federal Aviation Administration.
8. The maximum permitted Floor Area Ratio (“FAR”) for the site shall be in accordance with the attached Bulk Regulations Table. For the purposes of FAR calculations and measurements, the definitions in the Zoning Ordinance shall apply. The permitted FAR identified in the Bulk Regulations Table has been determined using a Net Site Area of 179,588 square feet. The permitted maximum FAR of 1.0 shall apply to the entire Planned Development and shall not be construed as a limitation on FAR for any of the 50 individual lots to be developed with single family homes.
9. Upon review and determination, “Part II Review”, pursuant to Section 17-13-0610 of the Zoning Ordinance, a Part II Review Fee shall be assessed by the Department of Housing and Economic Development. The fee, as determined by staff at the time, is final and binding on the Applicant and must be paid to the Department of Revenue prior to the issuance of any Part II approval.
10. The Site Plan-Larger Home Option and Site Plan-Typical Home Option, and Site Landscape Plan and Lot Landscape Plan shall be in substantial conformance with the Landscape Ordinance and any other corresponding regulations and guidelines. Final landscape plan review and approval will be by the Department of Housing and Economic Development. Any interim reviews associated with site plan review or Part II reviews, are conditional until final Part II approval.
11. The Applicant shall comply with Rules and Regulations for the Maintenance of Stockpiles promulgated by the Commissioners of the Departments of Streets and Sanitation, Environment and Buildings, under Section 13-32-125 of the Municipal Code, or any other provision of that Code.
12. The terms and conditions of development under this Planned Development ordinance may be modified administratively, pursuant to section 17-13-0611-A of the Zoning Ordinance by the Zoning Administrator upon the application for such a modification by the Applicant, its successors and assigns and, if different than the Applicant, the legal title holders and any ground lessors.
13. The Applicant acknowledges that it is in the public interest to design, construct and maintain the project in a manner which promotes, enables and maximizes universal access throughout the Property. Plans for all buildings and improvements on the Property shall be reviewed and approved by the Mayor’s Office for People with Disabilities to ensure compliance with all applicable laws and regulations related to access for persons with disabilities and to promote the highest standard of accessibility.

Applicant.	Nahshon Development, LLC
Address:	3670-3688 and 3700-3738 North Milwaukee, Chicago, Illinois
Introduced:	September 11, 2013
Plan Commission.	TBD

14. This Planned Development shall be governed by Section 17-13-0612 of the Zoning Ordinance. Unless substantial construction of at least one building has begun within the Planned Development within six (6) years of the date of passage of the Planned Development, this Planned Development ordinance shall lapse and the Commissioner of the Department of Housing and Economic Development shall initiate a Zoning Map Amendment to rezone the property to the RT-3.5, Residential Two-Flat, Townhouse and Multi-Unit District.

Applicant: Nahshon Development, LLC  
Address: 3670-3688 and 3700-3738 North Milwaukee, Chicago, Illinois  
Introduced: September 11, 2013  
Plan Commission: TBD



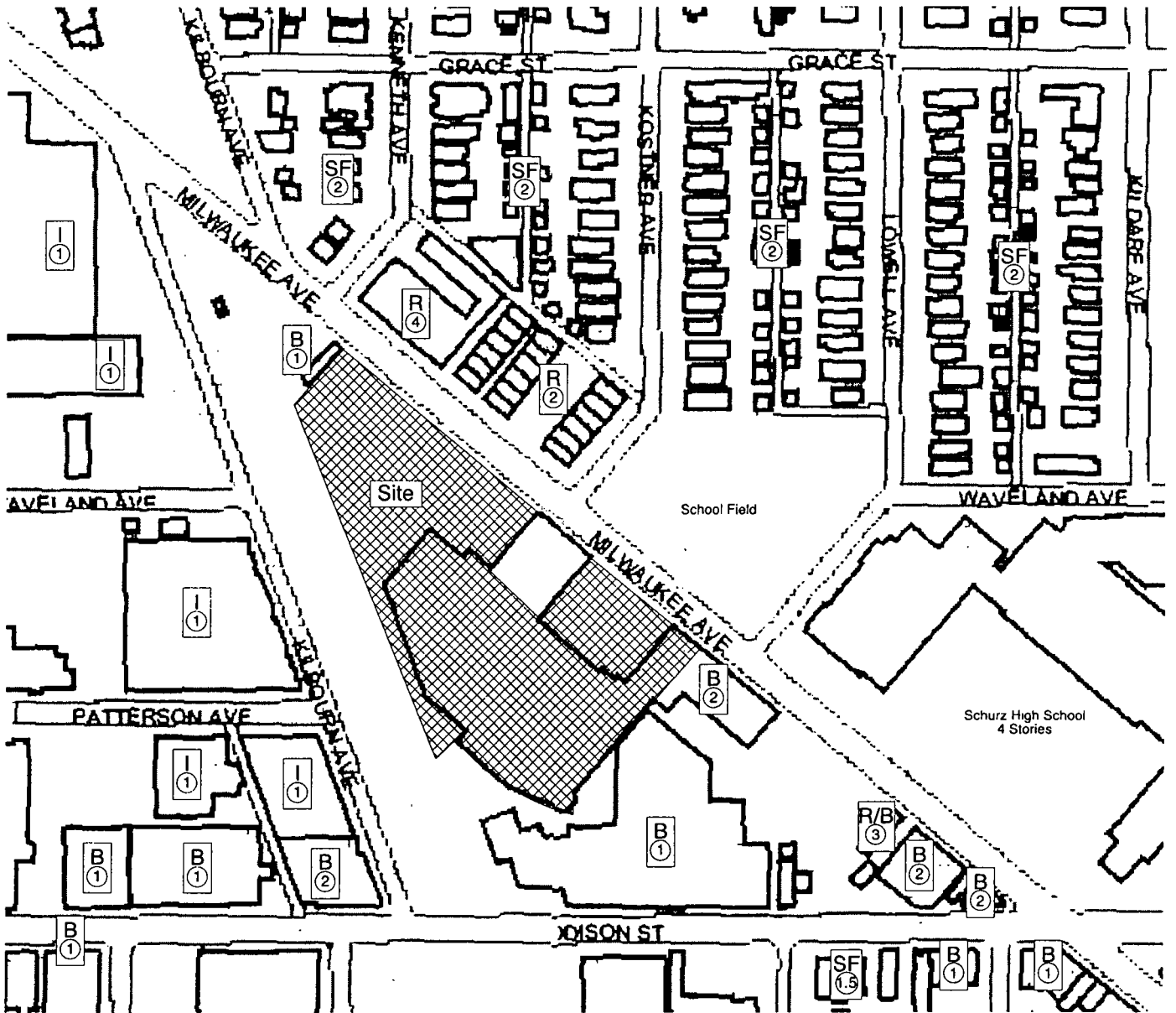

- |              |  |                                      |  |                           |
|--------------|--|--------------------------------------|--|---------------------------|
| # of Stories |  | Residential w/ Ground Floor Business |  | Single Family Residential |
|              |  | Business                             |  | Residential               |
|              |  | Industrial / Manufacturing           |  |                           |
|              |  |                                      |  |                           |

**Existing Land Use Map**

**Applicant:**  
 Nahshon Development, LLC  
 4252 North Cicero  
 Chicago, Illinois 60641

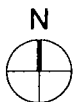

Introduced: September 11, 2008  
 Plan Commission : TBD

**Property Address:**  
 3670-3688 and 3700-3738 North  
 Milwaukee Avenue  
 Chicago, Illinois

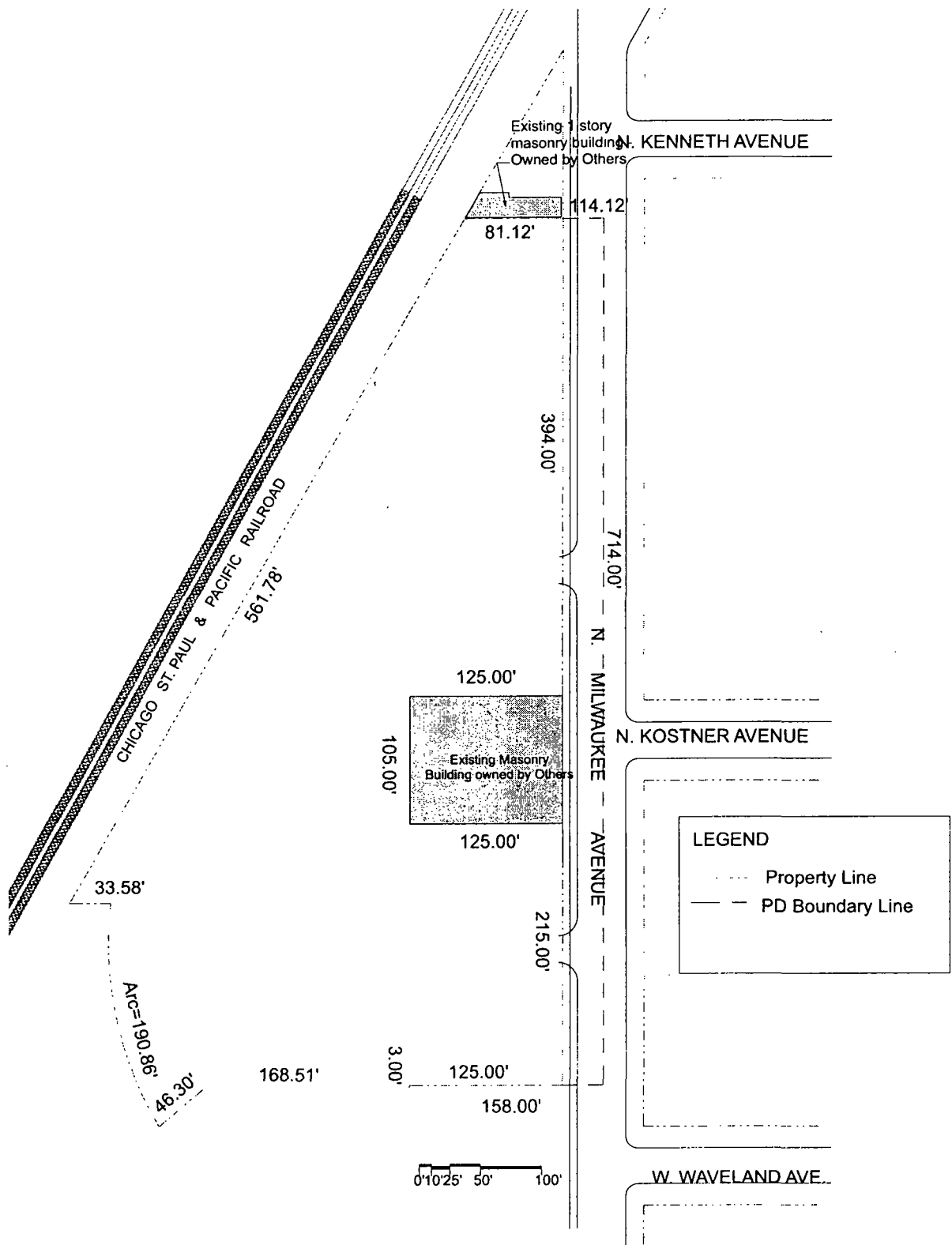

**PD Boundary and Property Line Map**

**Applicant:**  
 Nahshon Development, LLC  
 4252 North Cicero  
 Chicago, Illinois 60641

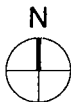

Introduced: September 11, 2008  
 Plan Commission : TBD

**Property Address:**  
 3670-3688 and 3700-3738 North  
 Milwaukee Avenue  
 Chicago, Illinois



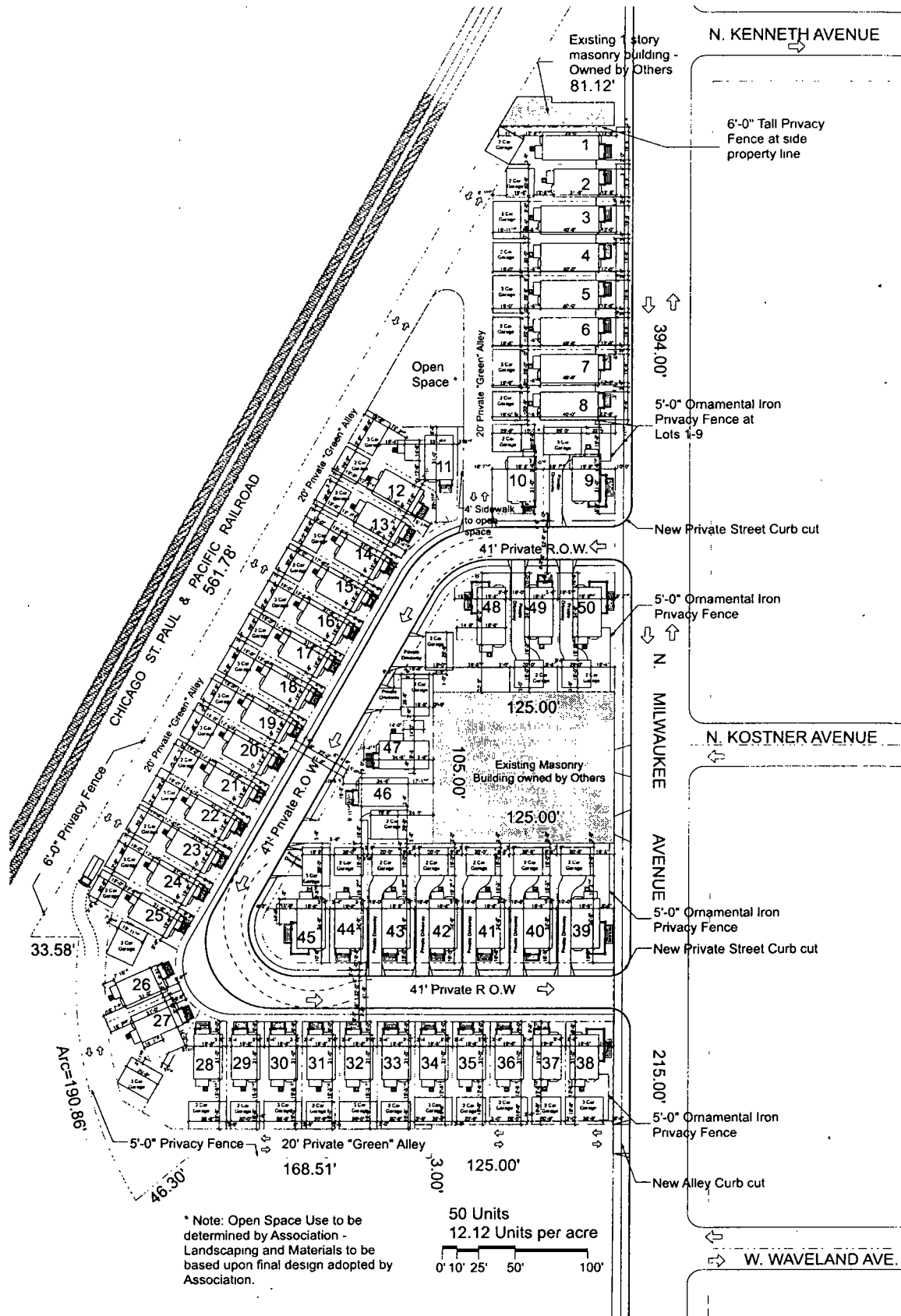

\* Note: Open Space Use to be determined by Association - Landscaping and Materials to be based upon final design adopted by Association.

**Site Plan - Larger Home Option**

**Applicant:**  
 Nahshon Development, LLC  
 4252 North Cicero  
 Chicago, Illinois 60641



Introduced: September 11, 2008  
 Plan Commission : TBD

**Property Address:**  
 3670-3688 and 3700-3738 North  
 Milwaukee Avenue  
 Chicago, Illinois

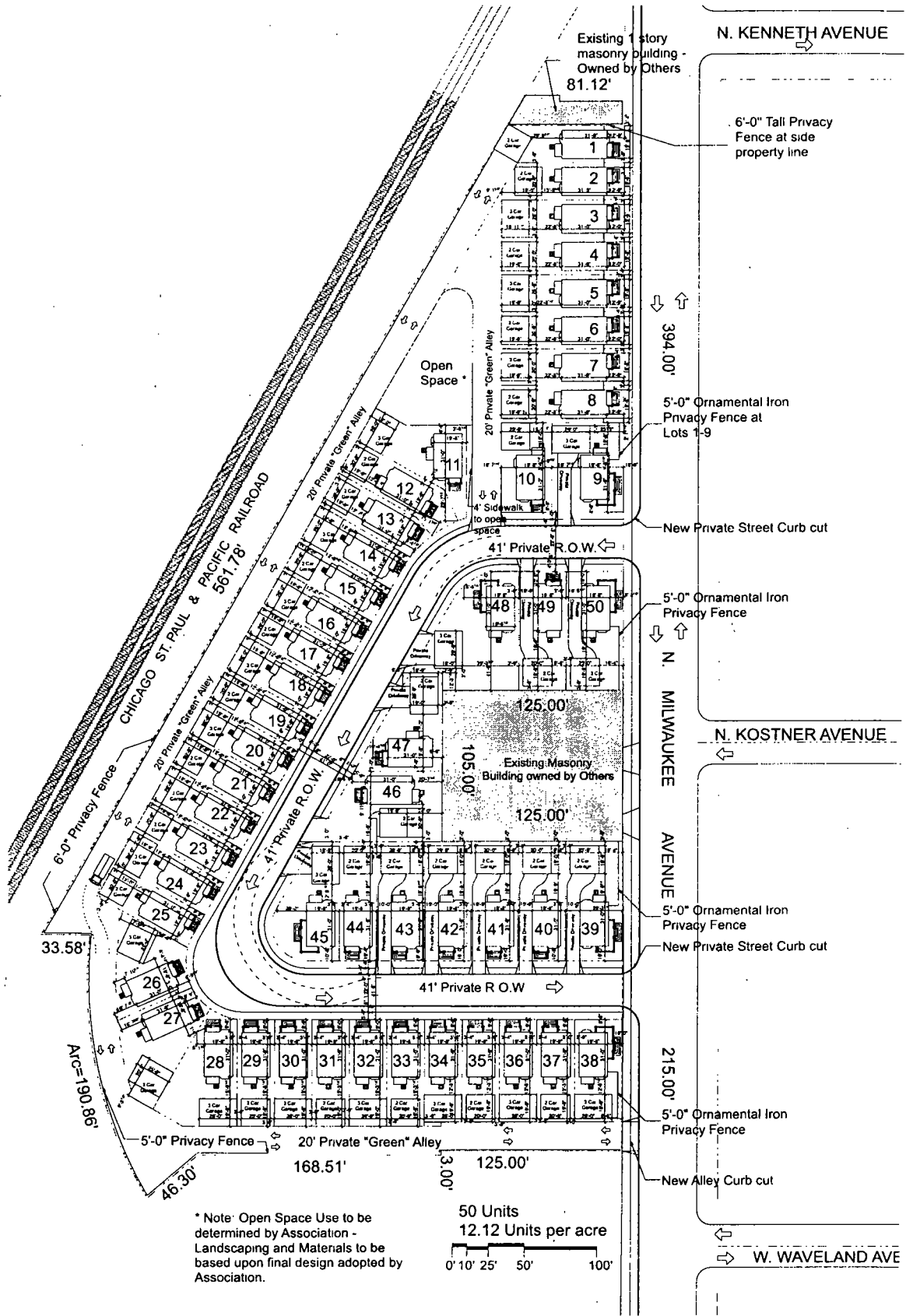

**Site Plan - Typical Home Option**

**Applicant:**  
Nahshon Development, LLC  
4252 North Cicero  
Chicago, Illinois 60641



Introduced September 11, 2008  
Plan Commission : TBD

**Property Address:**  
3670-3688 and 3700-3738 North  
Milwaukee Avenue  
Chicago, Illinois

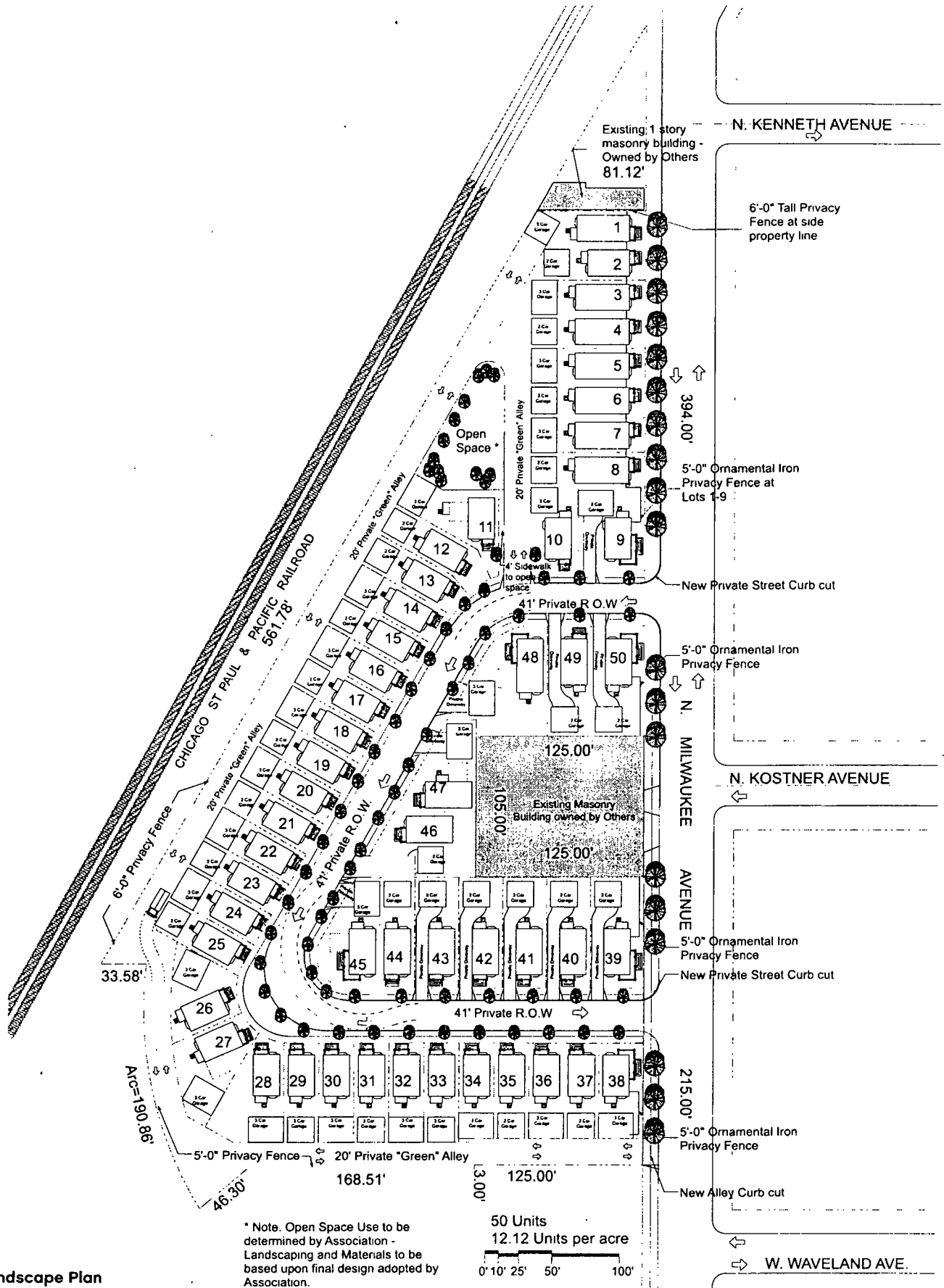

\* Note. Open Space Use to be determined by Association - Landscaping and Materials to be based upon final design adopted by Association.

50 Units  
12.12 Units per acre  
0' 10' 25' 50' 100'

**Site Landscape Plan**

**Applicant:**  
Nahshon Development, LLC  
4252 North Cicero  
Chicago, Illinois 60641



Introduced: September 11, 2008  
Plan Commission TBD

**Property Address:**  
3670-3688 and 3700-3738 North Milwaukee Avenue  
Chicago, Illinois

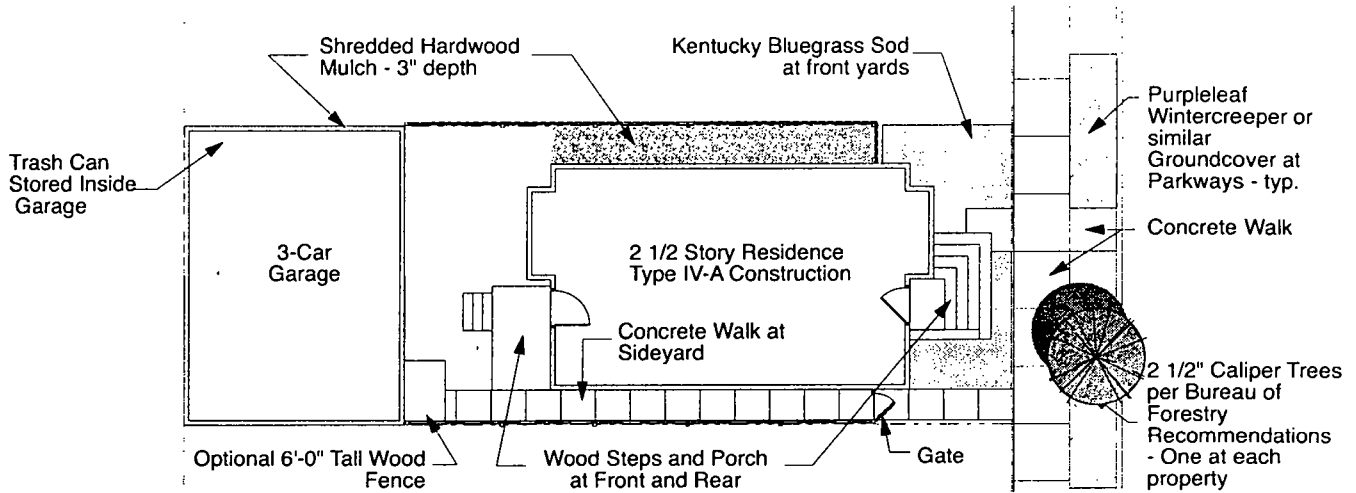

**Typical 3-Car Garage Option Site Plan**

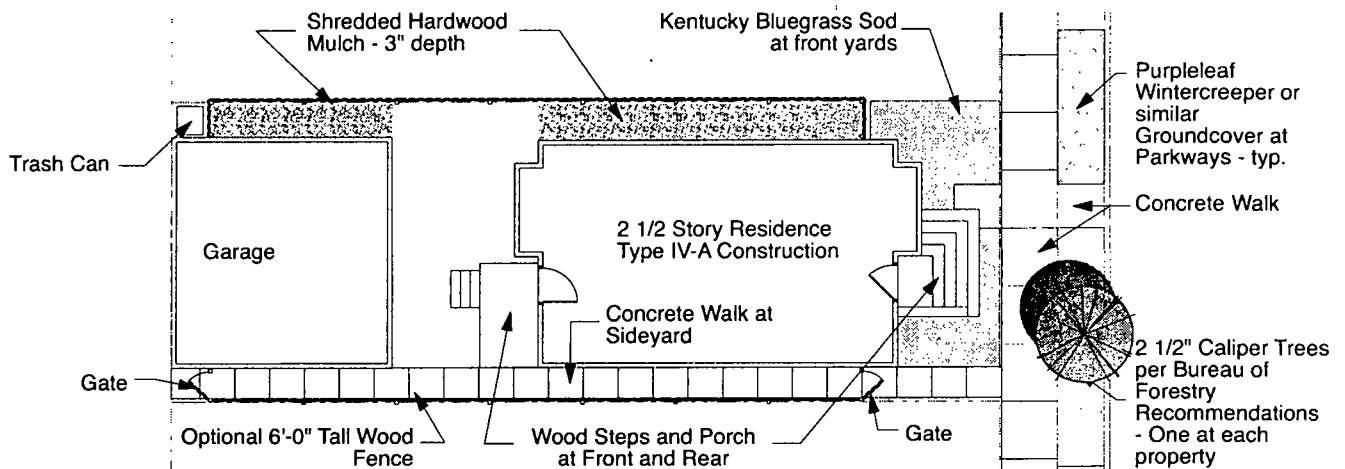

**Typical 2-Car Garage Site Plan**

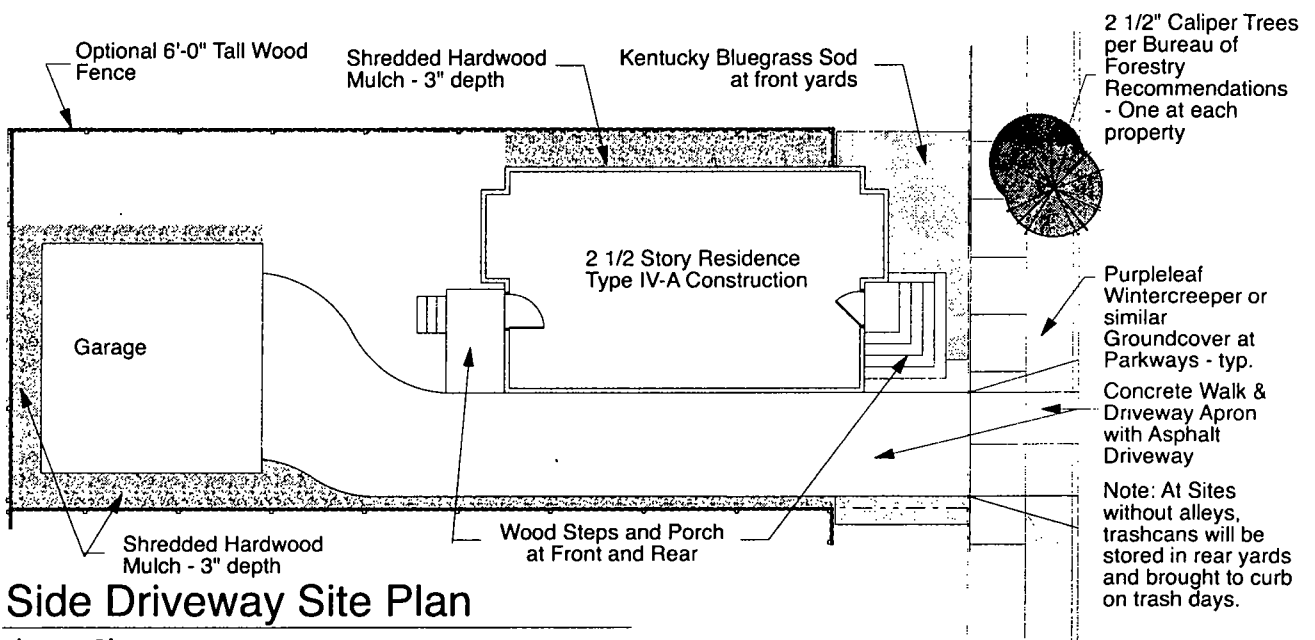

**Side Driveway Site Plan**

**Lot Landscape Plan**

**Applicant:**  
 Nahshon Development, LLC  
 4252 North Cicero  
 Chicago, Illinois 60641



Introduced: September 11, 2008  
 Plan Commission - TBD

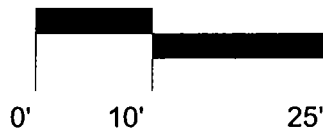

**Property Address:**  
 3670-3688 and 3700-3738 North  
 Milwaukee Avenue  
 Chicago, Illinois

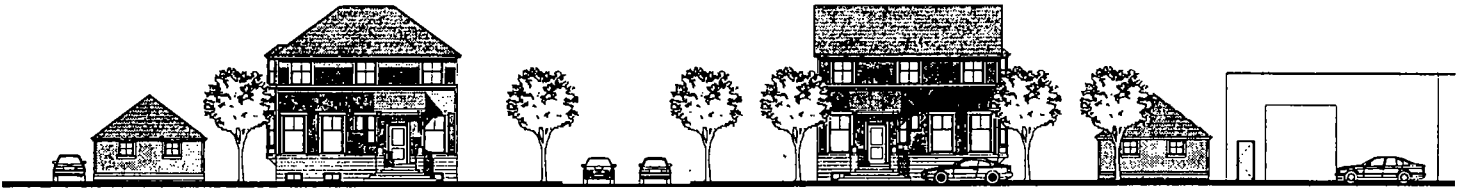
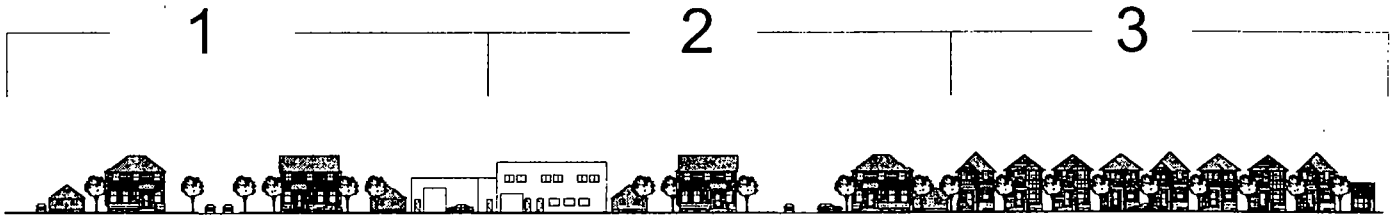

N. Milwaukee Ave. Elevation

1



N. Milwaukee Ave. Elevation

2



N. Milwaukee Ave. Elevation

3

Note: Elevations Subject to Change Due to Minor Floor Plan Changes

**Milwaukee Street Elevation**

**Applicant:**  
 Nahshon Development  
 4252 North Cicero  
 Chicago, Illinois 60641

**Property Address:**  
 3700 North Milwaukee Avenue  
 Chicago, Illinois

Introduced: September 11, 2008  
 Plan Commission : TBD



Typical Side Elevation

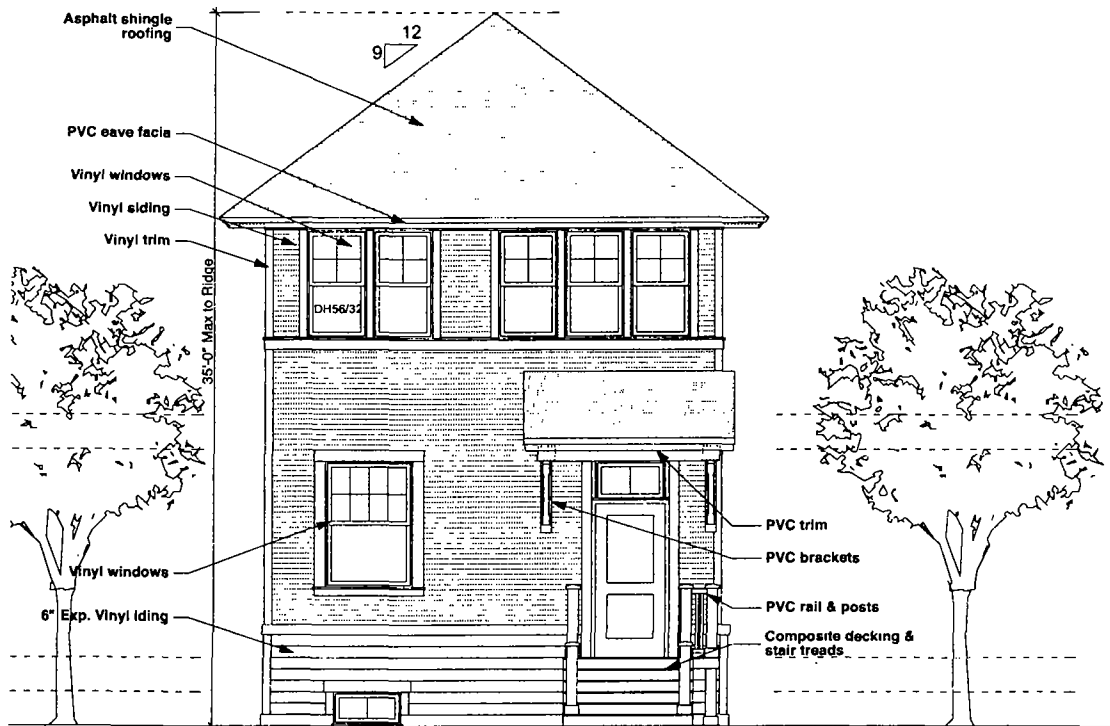

Typical Rear Elevation

Note: Elevations Subject to Change Due to Minor Floor Plan Changes

**Typical Side and Rear Elevation**

**Applicant:**  
 Nahshon Development  
 4252 North Cicero  
 Chicago, Illinois 60641

**Property Address:**  
 3700 North Milwaukee Avenue  
 Chicago, Illinois

Introduced: September 11, 2008  
 Plan Commission : TBD

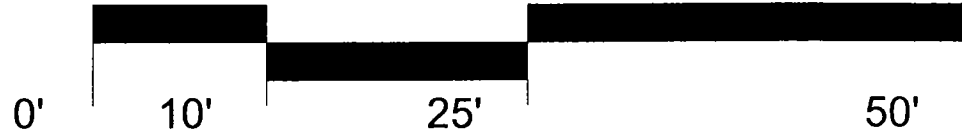
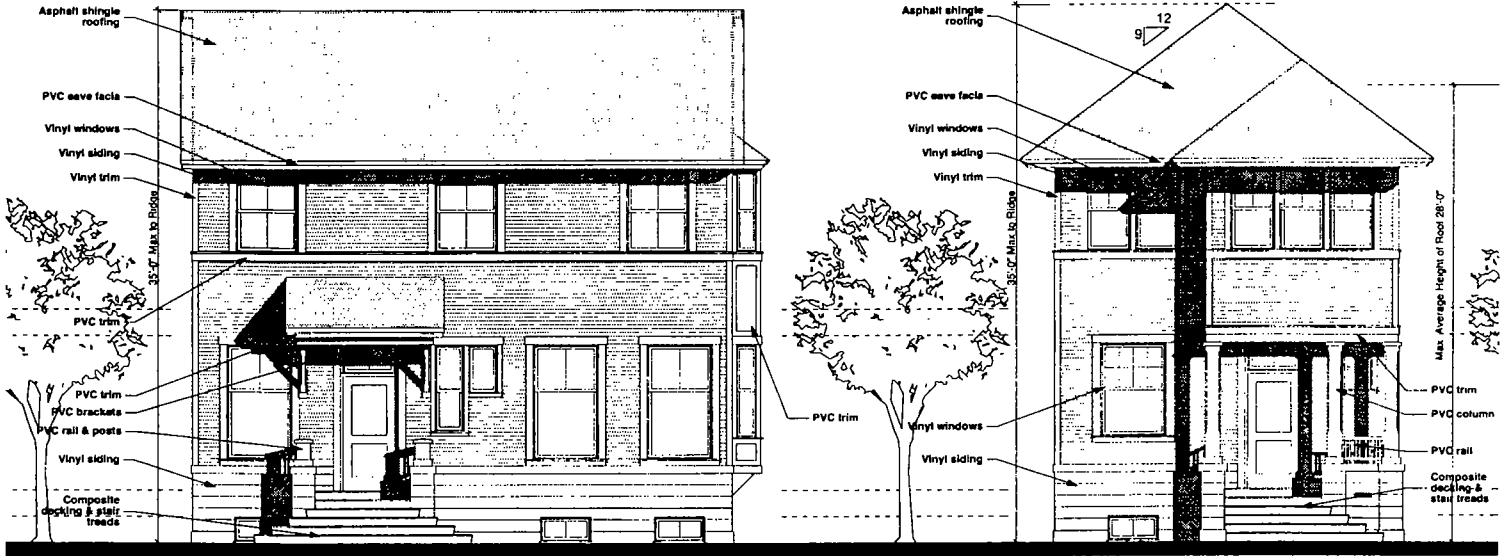
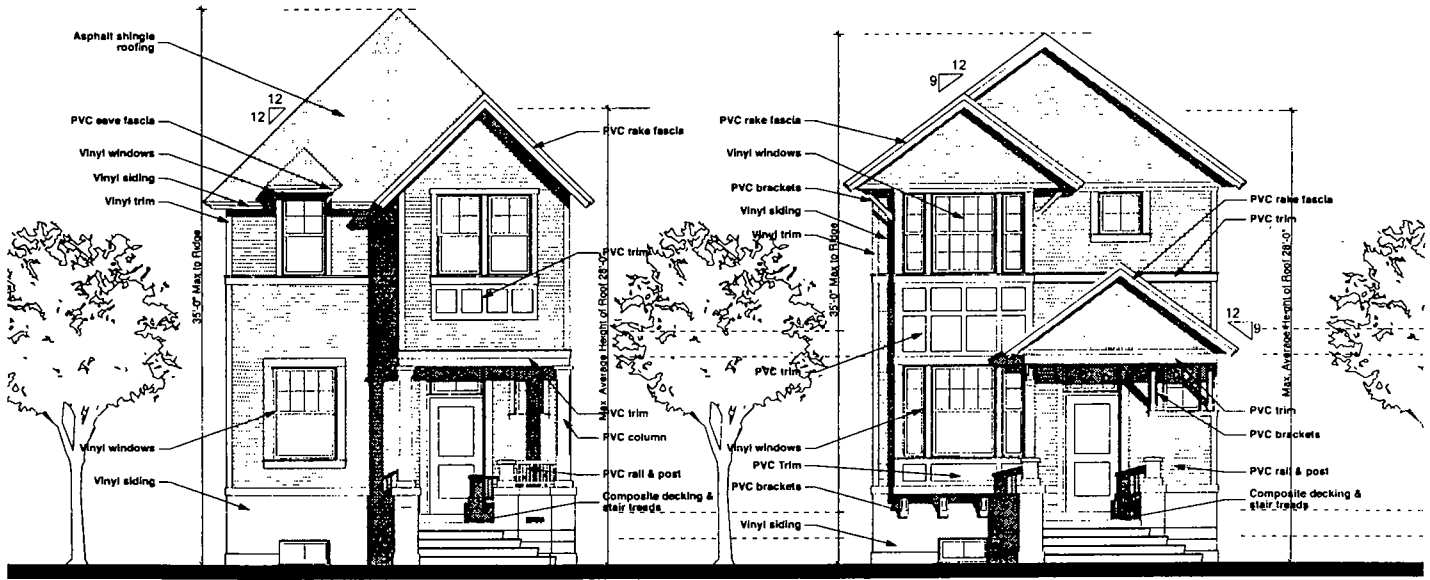

Note: Elevations Subject to Change Due to Minor Floor Plan Changes

**Front Elevation Options**

**Applicant:**  
 Nahshon Development  
 4252 North Cicero  
 Chicago, Illinois 60641

Introduced: September 11, 2008  
 Plan Commission : TBD

**Property Address:**  
 3700 North Milwaukee Avenue  
 Chicago, Illinois

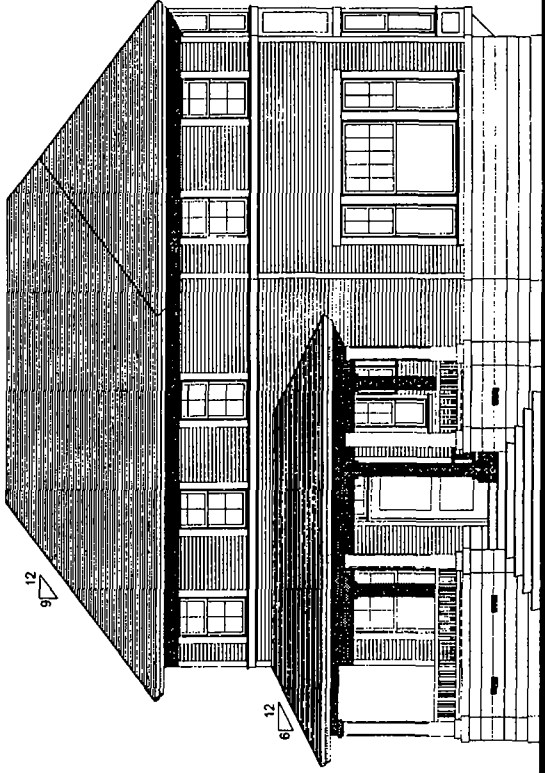

Front Elevation

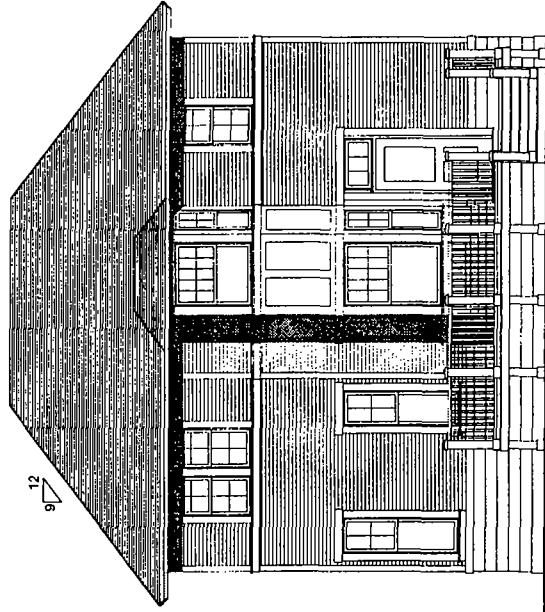

Rear Elevation

**"L" Floor Plan Elevation**

**Applicant:**  
 Nahshon Development  
 4252 North Cicero  
 Chicago, Illinois 60641  
 Introduced: September 11, 2008  
 Plan Commission TBD

**Property Address:**  
 3700 North Milwaukee Avenue  
 Chicago, Illinois

Note: Elevations Subject to Change Due to Minor Floor Plan Changes



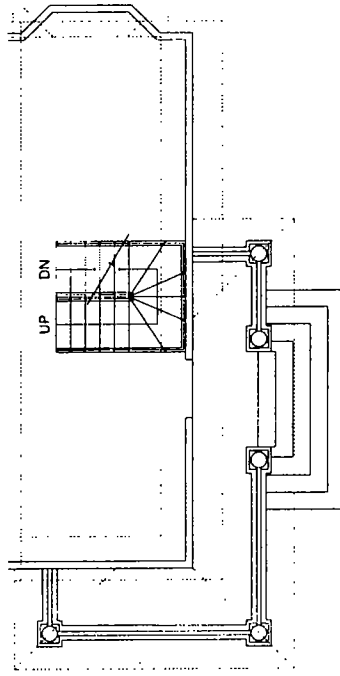
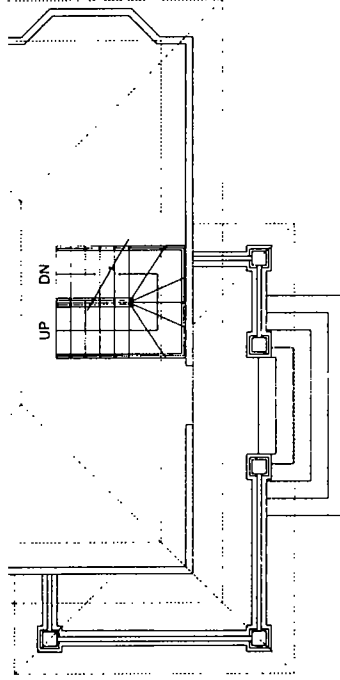
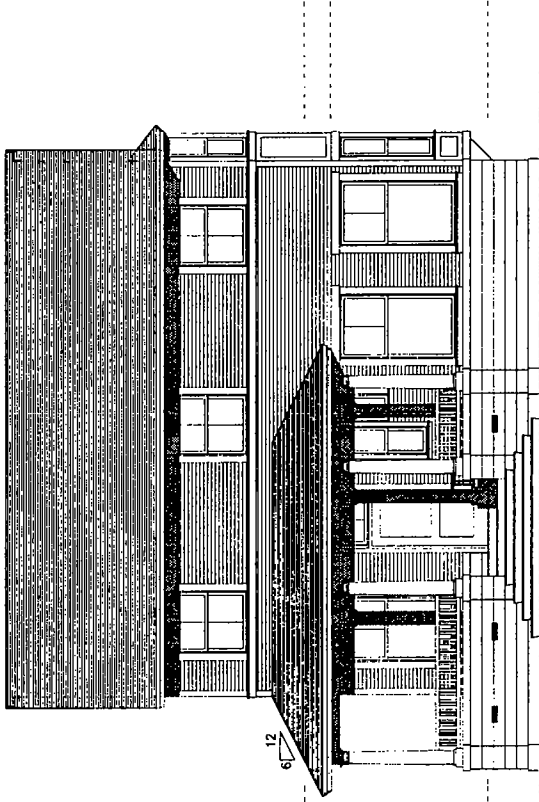
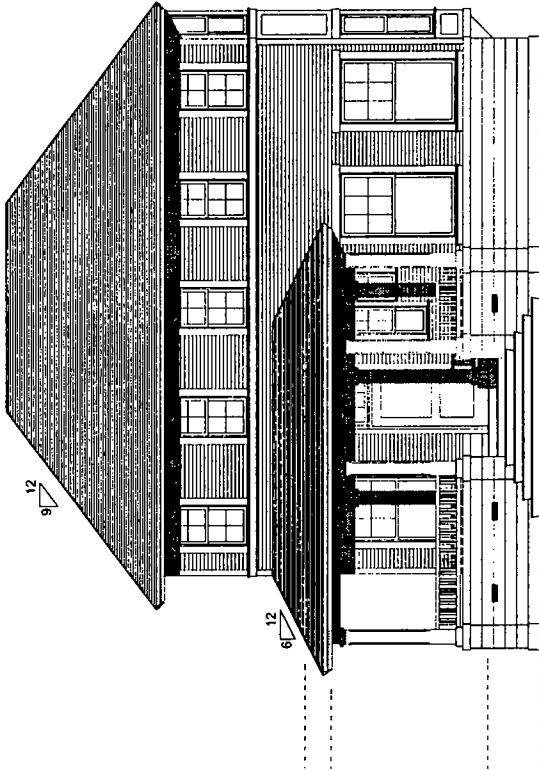

**Corner Lot Porch Options**

**Applicant:**  
 Naishon Development  
 4252 North Cicero  
 Chicago, Illinois 60641  
 Introduced September 11, 2008  
 Plan Commission : TBD

**Property Address:**  
 3700 North Milwaukee Avenue  
 Chicago, Illinois

Note: Elevations Subject to Change Due to Minor Floor Plan Changes

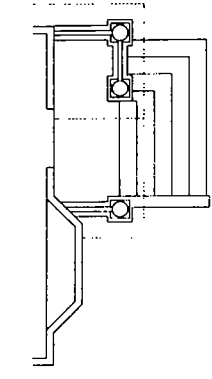
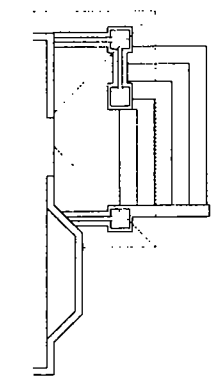
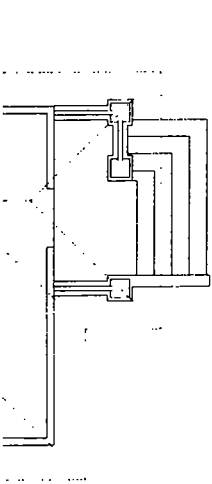
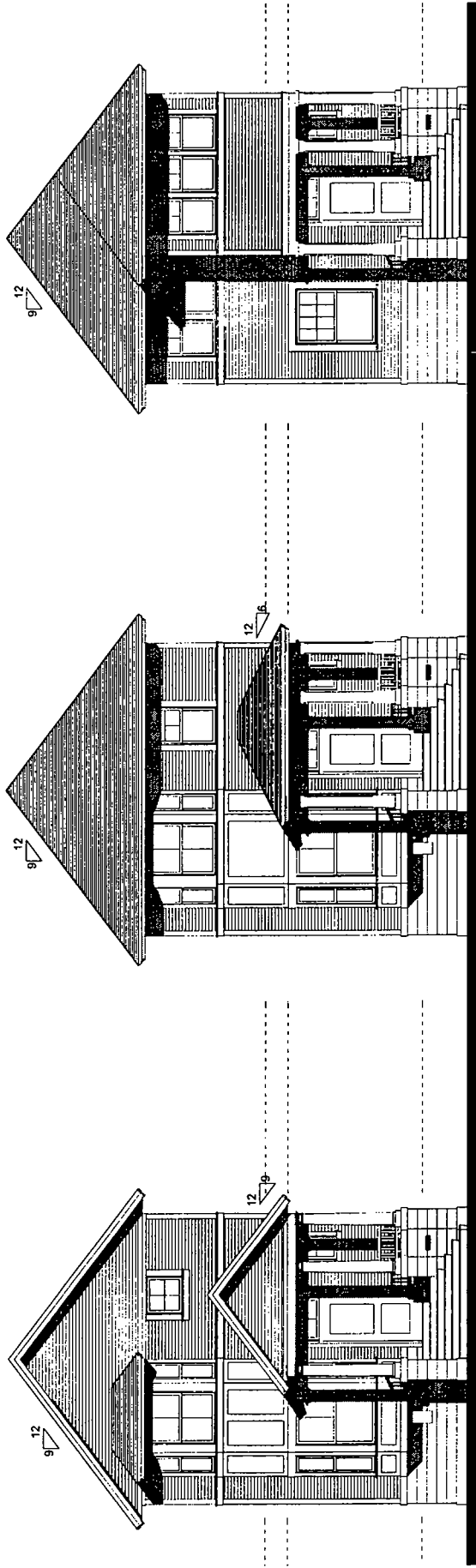

**Typical Home Porch Options**

**Applicant:**  
 Nahshon Development  
 4252 North Cicero  
 Chicago, Illinois 60641  
 Introduced September 11, 2008  
 Plan Commission TBD

**Property Address:**  
 3700 North Milwaukee Avenue  
 Chicago, Illinois

Note: Elevations Subject to Change Due to Minor Floor Plan Changes

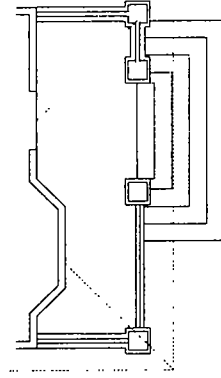
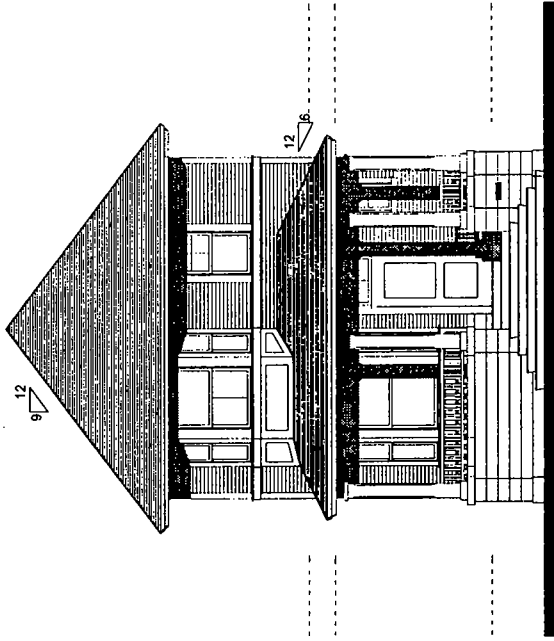

**Optional Full Width Porch on Typical Lot**

**Applicant:**  
 Nahshon Development  
 4252 North Cicero  
 Chicago, Illinois 60641  
 Introduced: September 11, 2008  
 Plan Commission TBD

**Property Address:**  
 3700 North Milwaukee Avenue  
 Chicago, Illinois





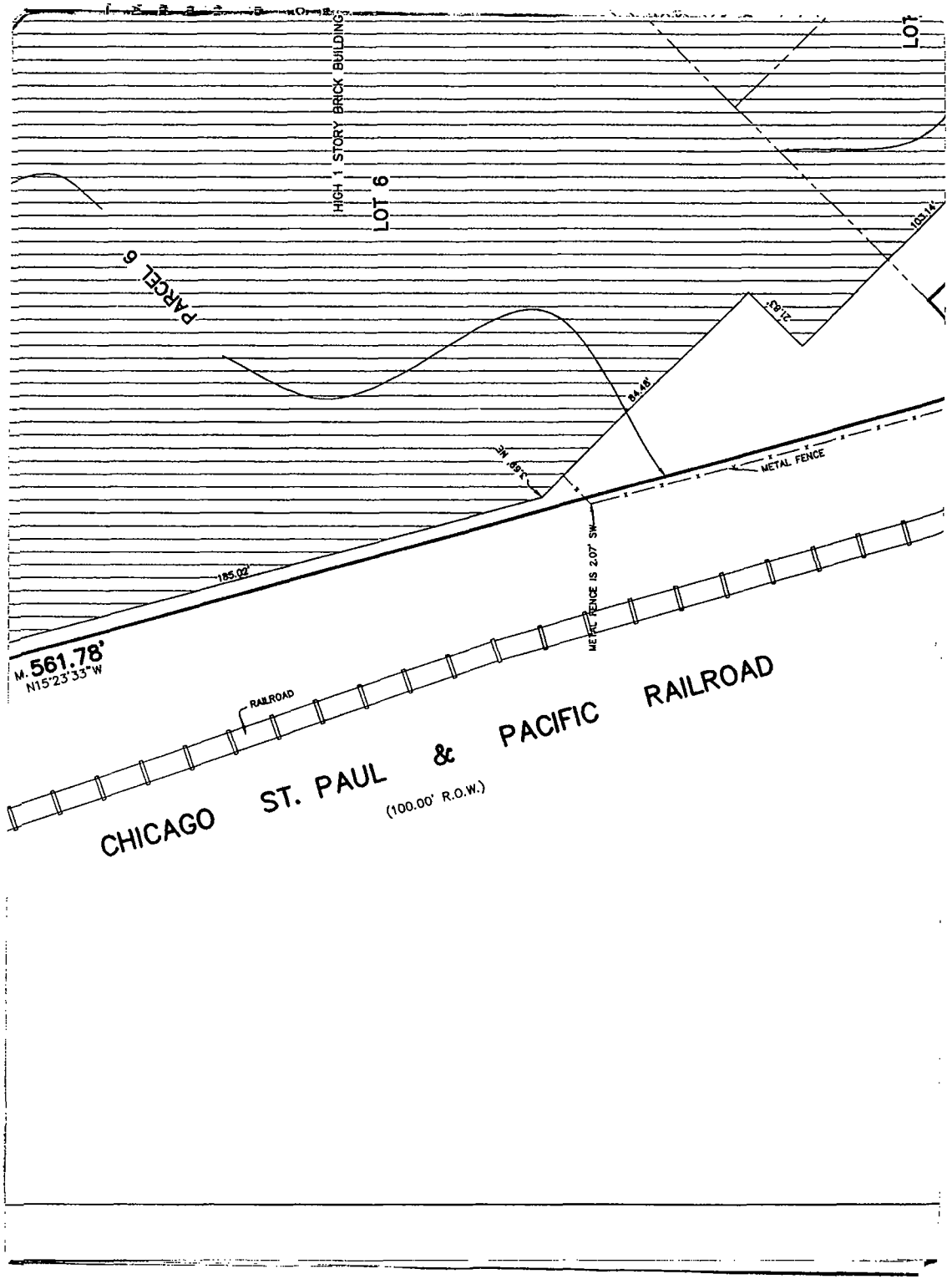

N15°23'33"W  
561.78'

HIGH 1 STORY BRICK BUILDING

LOT 6

PARCEL 6

LOT

RAILROAD

CHICAGO ST. PAUL & PACIFIC RAILROAD  
(100.00' R.O.W.)

METAL FENCE IS 2.07' SW

METAL FENCE

185.02'

34.65'

84.65'

27.85'

103.14'

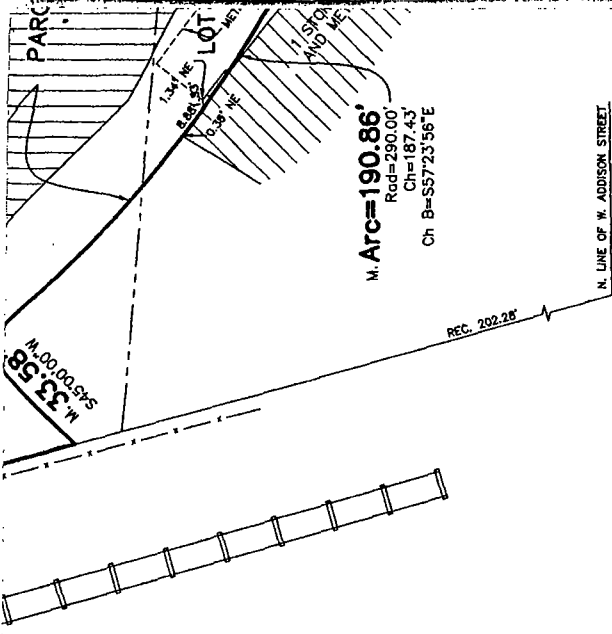

RECERTIFIED AUGUST 30, 2013 PER #2013-18282 [BS]

ORDERED BY: DUBIN RESIDENTIAL COMMUNITIES  
 ADDRESS: 3670 N MILWAUKEE AVENUE

CHECKED: DRAWN  
 RL

**GREMLEY & BIEDERMANN**  
 A Division of  
 PLCS, CORPORATION  
 LICENSE No. 184-005322  
 PROFESSIONAL LAND SURVEYORS  
 4805 NORTH ELSTON AVENUE, CHICAGO, IL 60630  
 TELEPHONE: (773) 685-5102 FAX: (773) 286-4184 EMAIL: INFO@PLCS-SURVEY.COM

ORDER NO. **2013-17938-001**  
 DATE: JUNE 18, 2013  
 SCALE: 1 INCH = 30 FEET  
 PAGE NO. **1 OF 1**

G:\CAD\2013\2013-17938\2013-17938-001.dwg

**SURVEY NOTES:**

Note R. & M. denotes Record and Measured distances  
 Distances are marked in feet and decimal parts thereof,  
 once report any differences BEFORE damage is done.  
 For easements, building lines and other restrictions not in  
 contract, title policy and local building fire regulations,  
 NO dimensions shall be assumed by scale measurement.  
 Monumentation or witness points were not set at the site  
 Unless otherwise noted herein the Bearing Basis, Elevation  
 COPYRIGTH GREMLEY & BIEDERMANN, INC. 2013

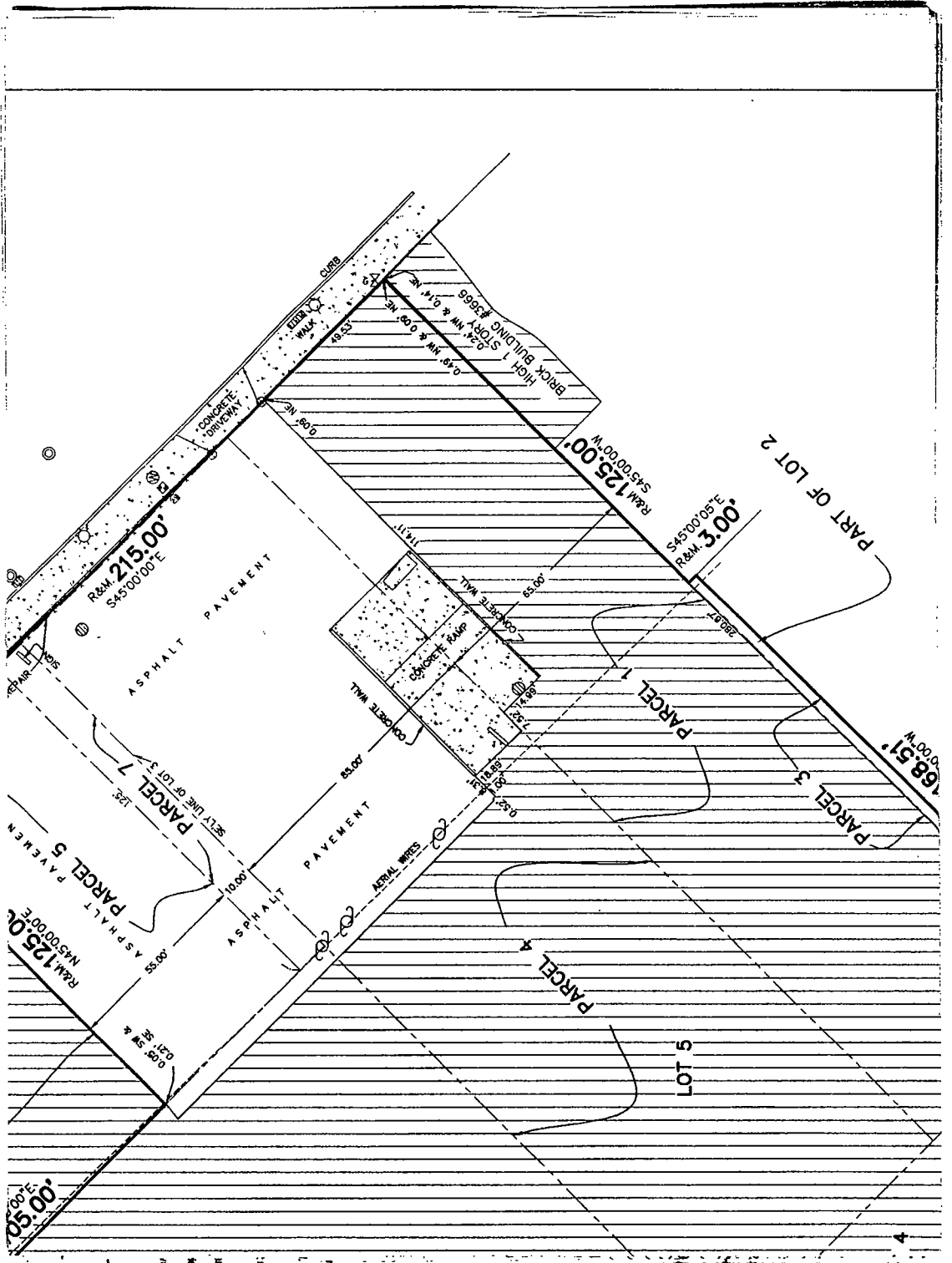



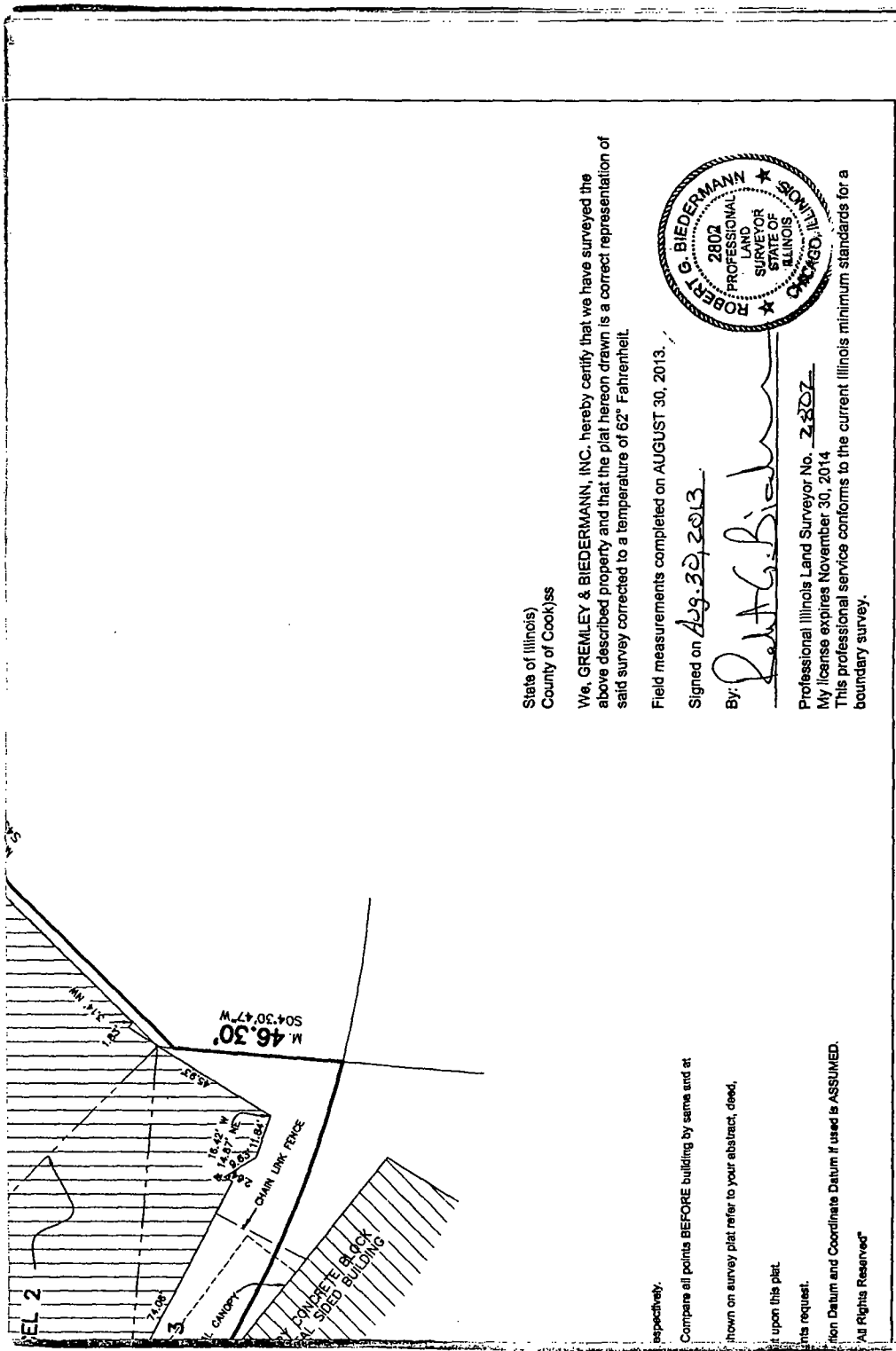

State of Illinois  
County of Cook/SS

We, GREMLEY & BIEDERMANN, INC. hereby certify that we have surveyed the above described property and that the plat hereon drawn is a correct representation of said survey corrected to a temperature of 62° Fahrenheit.

Field measurements completed on AUGUST 30, 2013.

Signed on Aug. 30, 2013

By: Robert G. Biedermann



Professional Illinois Land Surveyor No. 2807  
My license expires November 30, 2014

This professional service conforms to the current Illinois minimum standards for a boundary survey.

respectively.  
Compare all points BEFORE building by same and at  
shown on survey plat refer to your abstract, deed,  
upon this plat.  
this request.  
Non Datum and Coordinate Datum if used is ASSUMED.  
All Rights Reserved

plat thereof recorded February 25, 1884 in Book 19 of plats, Page 9, in Cook County, Illinois.

Parcel 8:

That part of Block 13 & Lot 4 in Block 14 lying Northeastly of a line 125.00 feet Southwestly from (measured at right angles) and parallel to the Western line of Milwaukee Avenue (excepting therefrom the Northwestly 20.00 feet of said Block 13), all in John and George L. Gray's vacation of that part of George Street lying between the right of way of the Chicago, Milwaukee and St. Paul Railroad and the Milwaukee tollway in Grayland and the Resubdivision of Block 13 and 14 of said Grayland in the Northwest Quarter of Section 22, Township 40 North, Range 13, East of the Third Principal Meridian, according to the plat thereof recorded February 25, 1884 as Document Number 527181 in Book 19 of Plats, Page 9, in Cook County, Illinois.

PROPERTY AREA=179,588 SQ. FT. OR 4.12 ACRES

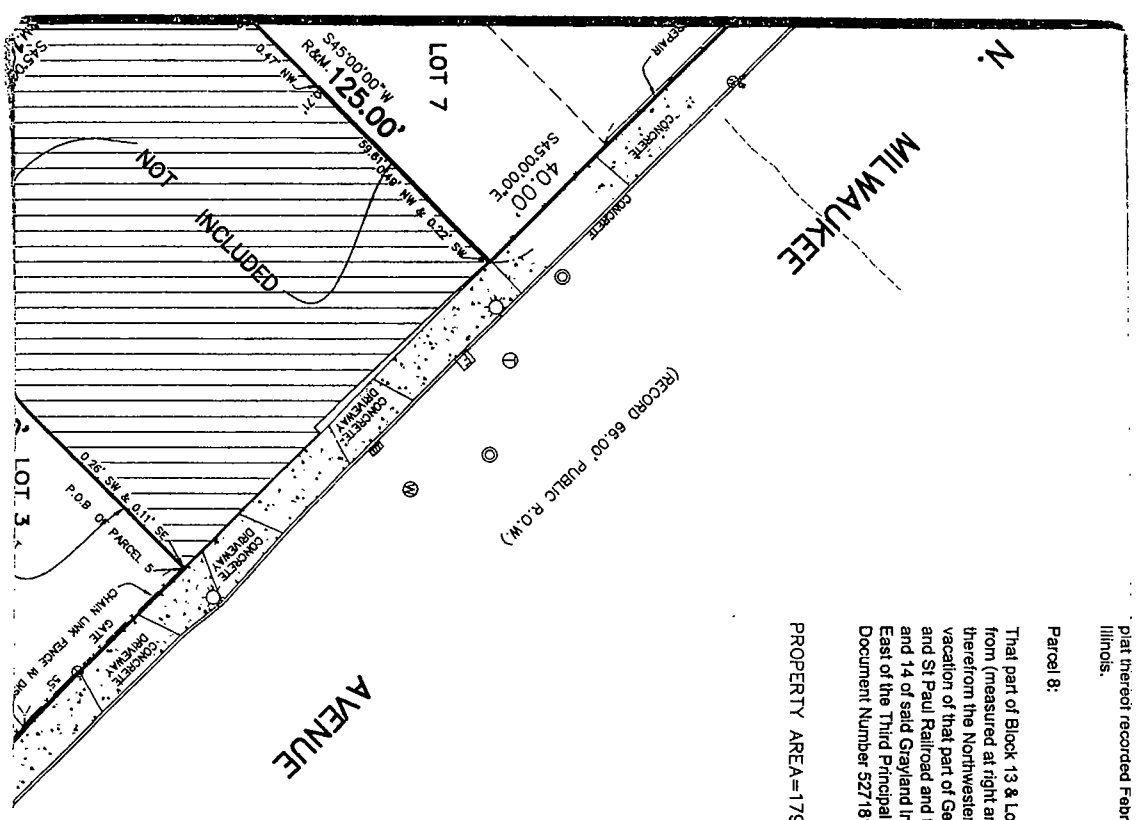

*Legend:*

⊗	Gas Valve
⊙	Storm CB
⊖	Storm Inlet
⊕	Water MH
⊗	Water Burial Box
⊖	Water Meter
⊕	Telephone MH
⊗	Utility Pole
⊙	Electric Vault
⊖	Electric Light Pole
⊕	Bumper Post
⊗	Bike Rock
⊙	Unclassified Manhole
⊖	Auto Sprinkler

# GREMLEY & BIEDERMANN

A DIVISION OF  
**PLCS Corporation**

LICENSE NO. 184-005322  
PROFESSIONAL LAND SURVEYORS

4505 NORTH ELSTON AVENUE, CHICAGO, IL 60630  
TELEPHONE: (773) 685-5102 FAX: (773) 286-4184 EMAIL: INFO@PLCS-SURVEY.COM

## Plat of Survey

Parcel 4:  
The Northwesterly 85 feet of Lot 5 in Wilcox Resubdivision of part of the North Half of Section 22, Township 40 North, Range 13, East of the Third Principal Meridian, according to the plat thereof recorded November 16, 1916 as Document 5994308, in Cook County, Illinois.

Parcel 5:  
That part of Lot 3 in John and George L. Gray's Resubdivision of Block 13 and Block 14 of Grayland in the Northwest Quarter of Section 22, Township 40 North, Range 13, East of the Third Principal Meridian, according to the plat thereof recorded February 25, 1894 in Book 19 of Plats, Page 9, described as follows:

Parcel 6:  
Beginning at a point on the Southwesterly line of Milwaukee Avenue which is 145 feet Southwesterly from the most Northern corner of said Lot 3; Thence Southwesterly on a line parallel to the Northwest line of said Lot 3, 125 feet; Thence Southeasterly on a line parallel with the Southwesterly line of Milwaukee Avenue 55 feet; Thence Northeasterly on a line parallel with the northwesterly line of said Lot 3, 125 feet to the Southwesterly line of Milwaukee Avenue, Thence Northwesterly 55 feet to the place of beginning, in Cook County, Illinois.

Parcel 7:  
Cox Resubdivision of part of the North Half of Section 22, Township 40 North, Range 13, East of the Third Principal Meridian, described as follows:

Parcel 8:  
The Southeastern 10 feet of the Northeastern 125 feet of Lot 3 in John and George L. Gray's Resubdivision of Blocks 13 and 14 of Grayland in the Northwest Quarter of Section 22, Township 40 North, Range 13, East of the Third Principal Meridian, according to the

Parcel 9:  
The Southeastern 10 feet of the Northeastern 125 feet of Lot 3 in John and George L. Gray's Resubdivision of Blocks 13 and 14 of Grayland in the Northwest Quarter of Section 22, Township 40 North, Range 13, East of the Third Principal Meridian, according to the