



City of Chicago



O2019-8492

Office of the City Clerk

Document Tracking Sheet

Meeting Date:	11/13/2019
Sponsor(s):	Misc. Transmittal
Type:	Ordinance
Title:	Zoning Reclassification Map No. 10-K at 4100-4230 W Ann Lurie Pl and 4044-4210 S Karlov Ave - App No. 20259
Committee(s) Assignment:	Committee on Zoning, Landmarks and Building Standards

#20259
INTRO DATE
NOV 13, 2019

ORDINANCE

BE IT ORDAINED BY THE CITY COUNCIL OF THE CITY OF CHICAGO:

SECTION 1. That the Chicago Zoning Ordinance be amended by changing all of the M2-3 Light Industry District symbols and indications as shown on Map 10-K in the area bounded by:

40th Street; Karlov Avenue; West Ann Lurie Place; a line 324 feet west of and parallel to Keeler Avenue as measured along the west line of Keeler Avenue

to those of an Industrial-Institutional Planned Development which is hereby established in the area above described, subject to such use and bulk regulations as are set forth in the Plan of Development herewith attached and made a part thereof and to no others.

SECTION 2. This Ordinance shall be in force and effect from and after its passage and due publication.

Address: 4100-4230 West Ann Lurie Place / 4044-4210 South Karlov Avenue, Chicago, IL

EAST\168966259.3

6.

INDUSTRIAL-INSTITUTIONAL PLANNED DEVELOPMENT NO. _____
PLANNED DEVELOPMENT STATEMENTS

1. The area delineated herein as Planned Development Number _____, (the “Planned Development”) consists of approximately 880,300 square feet of property which is depicted on the attached Planned Development Boundary and Property Line Map (the “Property”). Greater Chicago Food Depository is the owner of the Property and the “Applicant” for this Planned Development.
2. The requirements, obligations and conditions contained within this Planned Development shall be binding upon the Applicant, its successors and assigns and, if different than the Applicant, the legal title holders and any ground lessors. All rights granted hereunder to the Applicant shall inure to the benefit of the Applicant’s successors and assigns and, if different than the Applicant, the legal title holder and any ground lessors. Furthermore, pursuant to the requirements of Section 17-8-0400 of the Chicago Zoning Ordinance (the “Zoning Ordinance”), the Property, at the time of application for amendments, modifications or changes (administrative, legislative or otherwise) to this Planned Development, shall be under single ownership or designated control. Single designated control is defined in Section 17-8-0400 of the Zoning Ordinance.
3. All applicable official reviews, approvals or permits are required to be obtained by the Applicant or its successors, assignees or grantees. Any dedication or vacation of streets or alleys or grants of easements or any adjustment of the right-of-way shall require a separate submittal to the Department of Transportation on behalf of the Applicant or its successors, assigns or grantees.

Any requests for grants of privilege, or any items encroaching on the public way, shall be in compliance with the Planned Development.

Ingress or egress shall be pursuant to the Planned Development and may be subject to the review and approval of the Departments of Planning and Development and Transportation. Closure of all or any public street or alley during demolition or construction shall be subject to the review and approval of the Department of Transportation.

Pursuant to a negotiated and executed Perimeter Restoration Agreement (“Agreement”) by and between the Department of Transportation’s Division of Infrastructure Management and the Applicant, the Applicant shall provide improvements and restoration of all public way adjacent to the property, which may include, but not be limited to, the following as shall be reviewed and determined by the Department of Transportation’s Division of Infrastructure Management:

- Full width of streets
- Full width of alleys
- Curb and gutter
- Pavement markings
- Sidewalks
- ADA crosswalk ramps
- Parkway & landscaping

The Perimeter Restoration Agreement must be executed prior to any Department of Transportation and Planned Development Part II review permitting. The Agreement shall reflect that all work must comply

Applicant: Greater Chicago Food Depository
Address: 4100-4230 West Ann Lurie Place / 4044-4210 South Karlov Avenue, Chicago, IL
Introduced: November 13, 2019
Plan Commission: TBD

with current Rules and Regulations and must be designed and constructed in accordance with the Department of Transportation's Construction Standards for work in the Public Way and in compliance with the Municipal Code of Chicago Chapter 10-20. Design of said improvements should follow the Department of Transportation's Rules and Regulations for Construction in the Public Way as well as The Street and Site Plan Design Guidelines. Any variation in scope or design of public way improvements and restoration must be approved by the Department of Transportation.

4. This Planned Development consists of these 16 Statements; a Bulk Regulations and Data Table and the following exhibits and plans attached hereto prepared by Partners By Design and dated _____, 2019 (the "Plans"): an Existing Zoning Map; an Existing Land Use Map; a Planned Development Boundary and Property Line Map; a Site Plan; and Building Elevations (North, South, East and West), and a Landscape Plan and Landscape Details. In any instance where a provision of this Planned Development conflicts with the Chicago Building Code, the Building Code shall control. This Planned Development conforms to the intent and purpose of the Zoning Ordinance, and all requirements thereof, and satisfies the established criteria for approval as a Planned Development. In case of a conflict between the terms of this Planned Development Ordinance and the Zoning Ordinance, this Planned Development Ordinance shall control.
5. The following uses are permitted in the area delineated herein as an Industrial-Institutional Planned Development: Warehousing, Wholesaling and Freight Movement, including without limitation delivery, receipt, storage, re-packaging, and distribution of rescued food products and commodities to food pantries; Limited and Artisan Manufacturing, Production and Industrial Services, including without limitation meal preparation; Office; Business Support Services; Personal Service, including hands-on workforce training, workforce development services, and demonstration kitchen; Communication Service Establishments; Eating and Drinking Establishments; Sports and Recreation, Participant; Indoor Special Event including incidental liquor sales; Food and Beverage Retail Sales; Medical Service; General Retail Sales; Participant Sports and Recreation; Parks and Recreations; Community Centers; Community Gardens; Urban Farm; Co-located Wireless Communication Facilities; accessory parking, non-accessory parking and incidental and accessory uses.
6. On-Premise signs and temporary signs, such as construction and marketing signs, shall be permitted within the Planned Development, subject to the review and approval of DPD. Off-Premise signs are prohibited within the boundary of the Planned Development.
7. For purposes of height measurement, the definitions in the Zoning Ordinance shall apply. The height of any building shall also be subject to height limitations, if any, established by the Federal Aviation Administration.
8. The maximum permitted Floor Area Ratio ("FAR") for the Property shall be in accordance with the attached Bulk Regulations and Data Table. For the purposes of FAR calculations and measurements, the definitions in the Zoning Ordinance shall apply. The permitted overall FAR identified in the Bulk Regulations Table has been determined using a Net Site Area of 880,300 square feet, which includes the area of Keeler Avenue, which has been previously vacated.
9. Upon review and determination, "Part II Review", pursuant to Section 17-13-0610 of the Zoning Ordinance, a Part II Review Fee shall be assessed by DPD. The fee, as determined by staff at the time, is

Applicant: Greater Chicago Food Depository
Address: 4100-4230 West Ann Lurie Place / 4044-4210 South Karlov Avenue, Chicago, IL
Introduced: November 13, 2019
Plan Commission: TBD

final and binding on the Applicant and must be paid to the Department of Revenue prior to the issuance of any Part II approval.

10. The Site and Landscape Plans shall be in substantial conformance with the Landscape Ordinance and any other corresponding regulations and guidelines. Final landscape plan review and approval will be by DPD. Any interim reviews associated with site plan review or Part II reviews, are conditional until final Part II approval.
11. The Applicant shall comply with Rules and Regulations for the Maintenance of Stockpiles promulgated by the Commissioners of the Departments of Streets and Sanitation, Fleet and Facility Management and Buildings, under Section 13-32-125 of the Municipal Code, or any other provision of that Code.
12. The terms and conditions of development under this Planned Development ordinance may be modified administratively, pursuant to section 17-13-0611-A of the Zoning Ordinance by the Zoning Administrator upon the application for such a modification by the Applicant, its successors and assigns and, if different than the Applicant, the legal title holders and any ground lessors.
13. The Applicant acknowledges that it is in the public interest to design, construct and maintain the project in a manner which promotes, enables and maximizes universal access throughout the Property. Plans for all buildings and improvements on the Property shall be reviewed and approved by the Mayor's Office for People with Disabilities to ensure compliance with all applicable laws and regulations related to access for persons with disabilities and to promote the highest standard of accessibility.
14. The Applicant acknowledges that it is in the public interest to design, construct, renovate and maintain all buildings in a manner that provides healthier indoor environments, reduces operating costs and conserves energy and natural resources. The Applicant shall obtain the number of points necessary to meet the requirements of the Chicago Sustainable Development Policy, in effect at the time the Part II review process is initiated for each improvement that is subject to the aforementioned Policy and must provide documentation verifying compliance.
15. The Applicant acknowledges that it is the policy of the City to maximize opportunities for Minority and Women-owned Business Enterprises ("M/WBEs") and city residents to compete for contracts and jobs on construction projects approved through the planned development process. To assist the city in promoting and tracking such M/WBE and city resident participation, an applicant for planned development approval shall provide information at three points in the city approval process. First, the applicant must submit to DPD, as part of its application for planned development approval, an M/WBE Participation Proposal. The M/WBE Participation Proposal must identify the applicant's goals for participation of certified M/WBE firms in the design, engineering and construction of the project, and of city residents in the construction work. The city encourages goals of (i) 26% MBE and 6% WBE participation (measured against the total construction budget for the project or any phase thereof), and (ii) 50% city resident hiring (measured against the total construction work hours for the project or any phase thereof). The M/WBE Participation Proposal must include a description of the Applicant's proposed outreach plan designed to inform M/WBEs and city residents of job and contracting opportunities. Second, at the time of the Applicant's submission for Part II permit review for the project or any phase thereof, the Applicant must submit to DPD (a) updates (if any) to the Applicant's preliminary outreach plan, (b) a description of the Applicant's outreach efforts and evidence of such outreach, including, without limitation, copies of certified letters to M/WBE contractor associations and

Applicant: Greater Chicago Food Depository
Address: 4100-4230 West Ann Lurie Place / 4044-4210 South Karlov Avenue, Chicago, IL
Introduced: November 13, 2019
Plan Commission: TBD

the ward office of the alderman in which the project is located and receipts thereof; (c) responses to the Applicant's outreach efforts, and (d) updates (if any) to the applicant's M/WBE and city resident participation goals. Third, prior to issuance of a Certificate of Occupancy for the project or any phase thereof, the Applicant must provide DPD with the actual level of M/WBE and city resident participation in the project or any phase thereof, and evidence of such participation. In addition to the forgoing, DPD may request such additional information as the department determines may be necessary or useful in evaluating the extent to which M/WBEs and city residents are informed of and utilized in planned development projects. All such information will be provided in a form acceptable to the Zoning Administrator. DPD will report the data it collects regarding projected and actual employment of M/WBEs and city residents in planned development projects twice yearly to the Chicago Plan-Commission and annually to the Chicago City Council and the Mayor.

16. This Planned Development shall be governed by Section 17-13-0612 of the Zoning Ordinance. Should this Planned Development ordinance lapse, the Commissioner of DPD shall initiate a Zoning Map Amendment to rezone the property to the M2-3 Light Industry District.

Applicant: Greater Chicago Food Depository
Address: 4100-4230 West Ann Lurie Place / 4044-4210 South Karlov Avenue, Chicago, IL
Introduced: November 13, 2019
Plan Commission: TBD

INDUSTRIAL-INSTITUTIONAL PLANNED DEVELOPMENT NO. _____
BULK REGULATIONS AND DATA TABLE

Gross Site Area (sf):	979,570
Area of Public Rights-of-Way (sf):	99,270
Net Site Area (sf):	880,300
Maximum Floor Area Ratio:	1
Accessory Off-Street Parking Spaces:	300
Minimum Off-Street Loading Spaces:	0
Maximum Building Height:	50'
Minimum Setbacks:	In conformance with the Plans
Dwelling Units:	0

Applicant: Greater Chicago Food Depository
Address: 4100-4230 West Ann Lurie Place / 4044-4210 South Karlov Avenue, Chicago, IL
Introduced: November 13, 2019
Plan Commission: TBD

EXISTING LAND-USE MAP

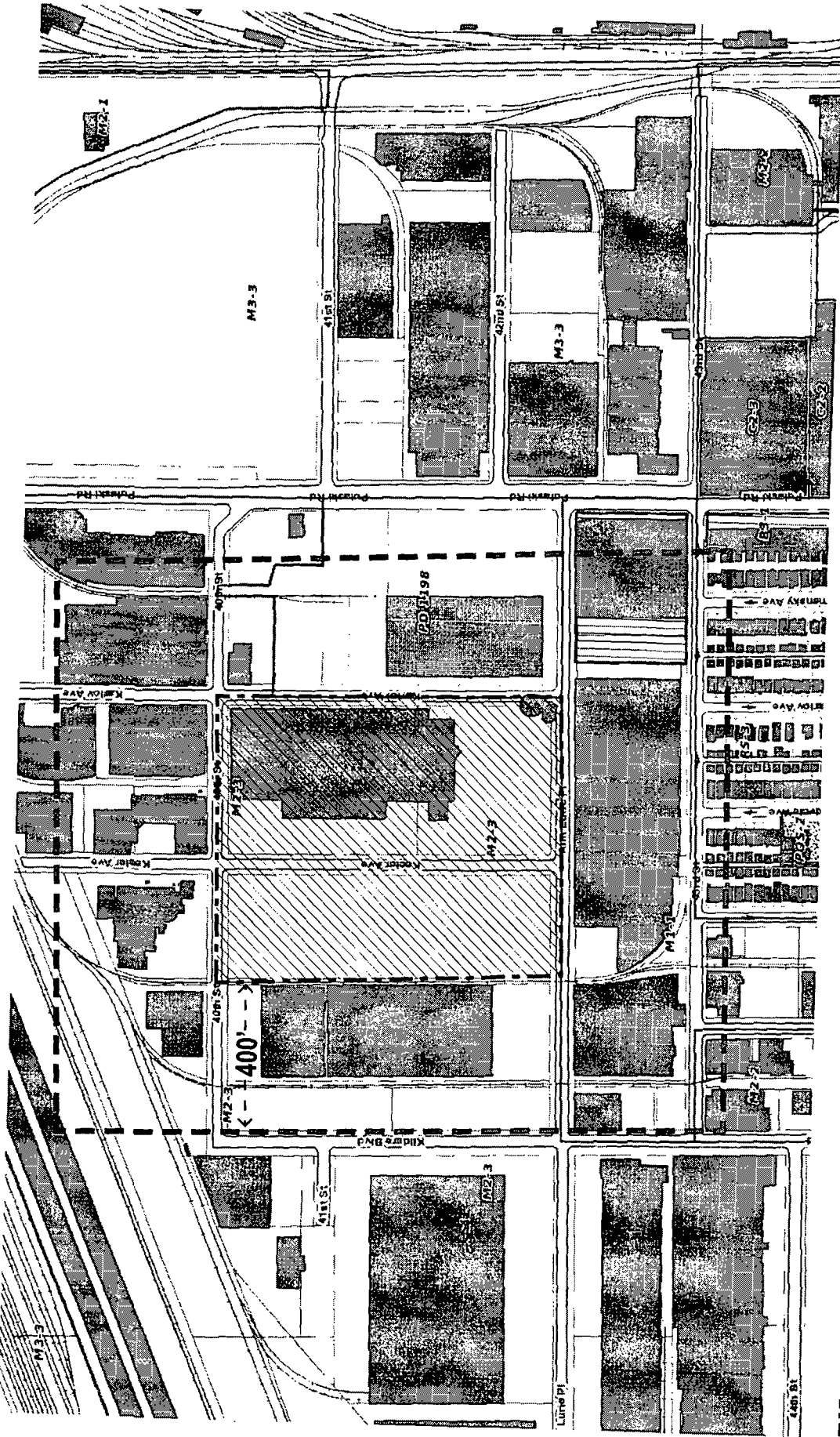

PD BOUNDARY

* ALL BUILDINGS IN 400' ZONE ARE SINGLE STORY INDUSTRIAL BUILDINGS

APPLICANT: Greater Chicago Food Depository
 ADDRESS: 4100-4230 West Ann Lurie Place / 4044-4210 South Karlov Avenue, Chicago, IL
 INTRODUCED: November 13, 2019
 PLAN COMMISSION: TBD



PLANNED DEVELOPMENT BOUNDARY

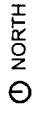
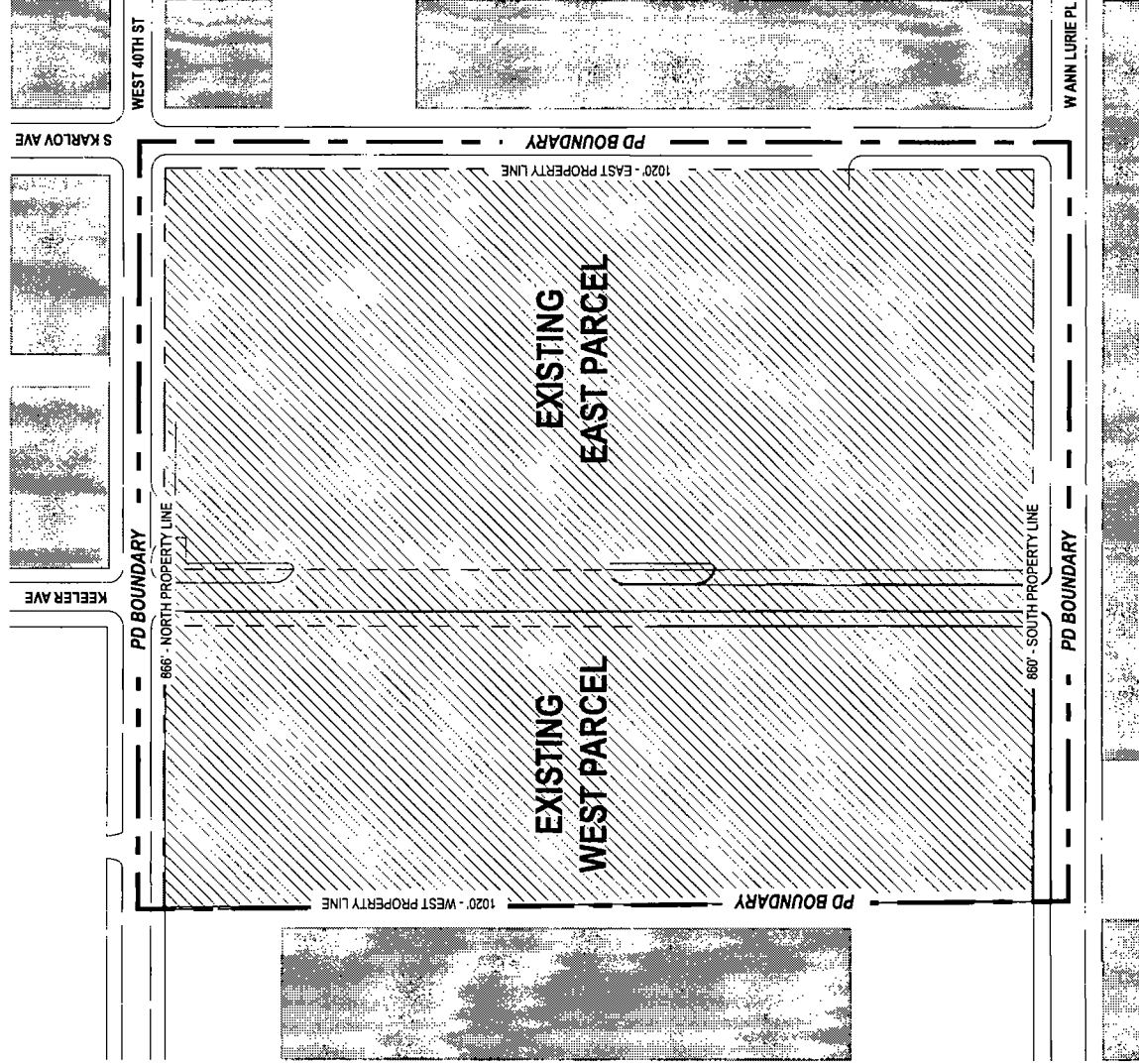

APPLICANT: Greater Chicago Food Depository
ADDRESS: 4100-4230 West Ann Lurie Place / 4044-4210 South Karlov Avenue, Chicago, IL
INTRODUCED: November 13, 2019
PLAN COMMISSION: TBD

SITE/LANDSCAPE PLAN

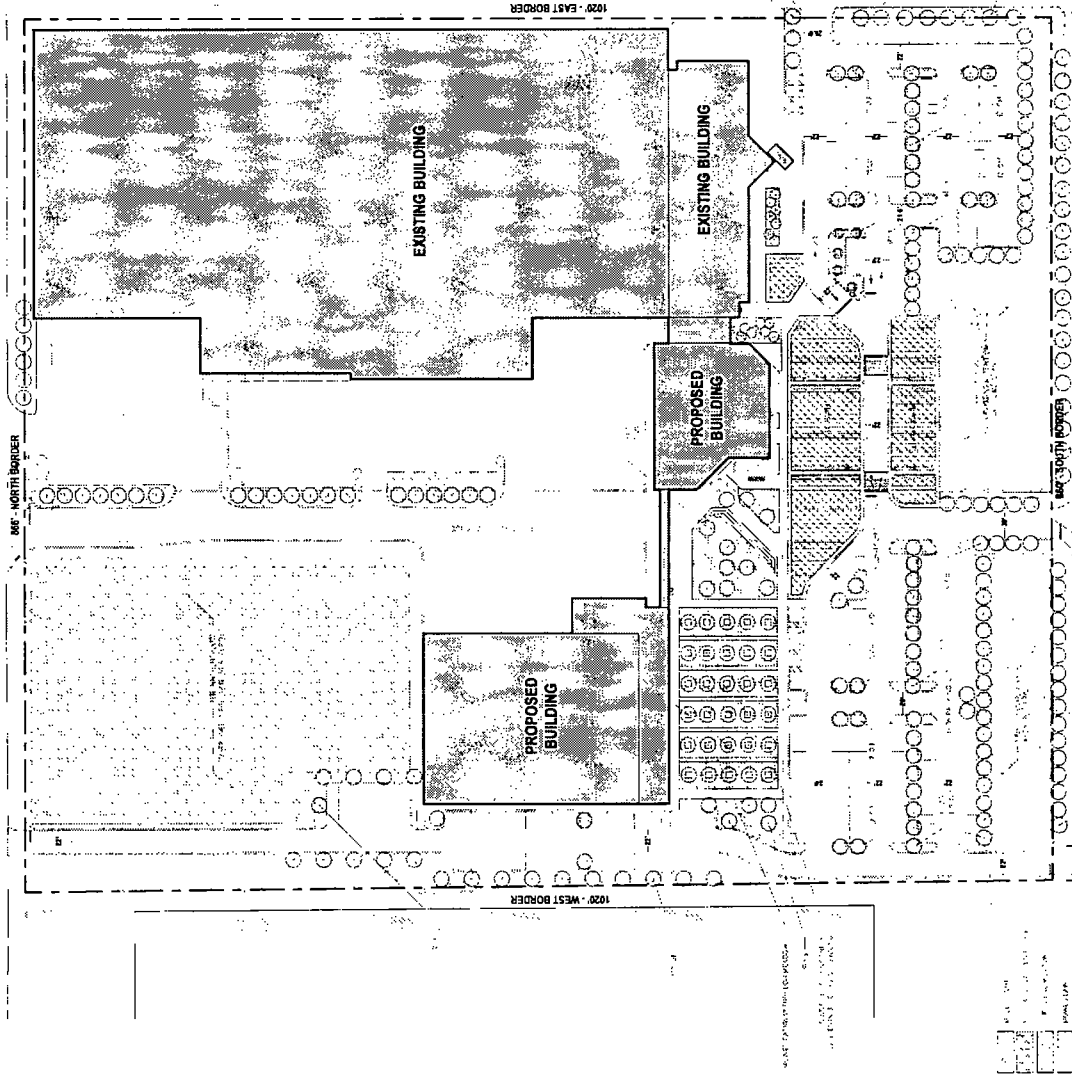

PARKING LOT VEHICULAR USE AREA CALCULATIONS

TOTAL PARKING STALLS PROVIDED	296
ACCESSIBLE PARKING STALLS PROVIDED	7
TOTAL VEHICULAR USE AREA	109,747 SF
REQUIRED INTERNAL LANDSCAPED AREA	10,800 SF
ACTUAL LANDSCAPED AREA	51,000 SF
TOTAL SITE LANDSCAPE	291,600 SF
REQUIRED INTERNAL TREE PLANTING	.87
ACTUAL TREE PLANTING	118

TREE SCHEDULE

CODE	BOTANIC NAME	COMMON NAME	QUANTITY
DM	Quercus macrocarpa	Bur Oak	57
OB	Quercus bicolor	Swamp White Oak	27
AS	Acer saccharum	Sweet Maple	43
NS	Nyssa sylvatica	Black Gum	10
AG	Alnus glutinosa	Black Alder	5
GB	Ginkgo biloba	Ginkgo 'Princeton Sentry'	10
CC	Cercis canadensis	Eastern Redbud	12
MD	Malus domestica	Apple Tree	10
BN	Betula nigra	River Birch	7
PP	Prunus persica 'Reliance'	Peach Tree	10
PA	Prunus avium 'Meteor'	Cherry Tree	10



APPLICANT: Greater Chicago Food Depository
ADDRESS: 4100-4230 West Ann Lurie Place / 4044-4210 South Karlov Avenue, Chicago, IL
INTRODUCED: November 13, 2019
PLAN COMMISSION: TBD

LINK BUILDING PLAN

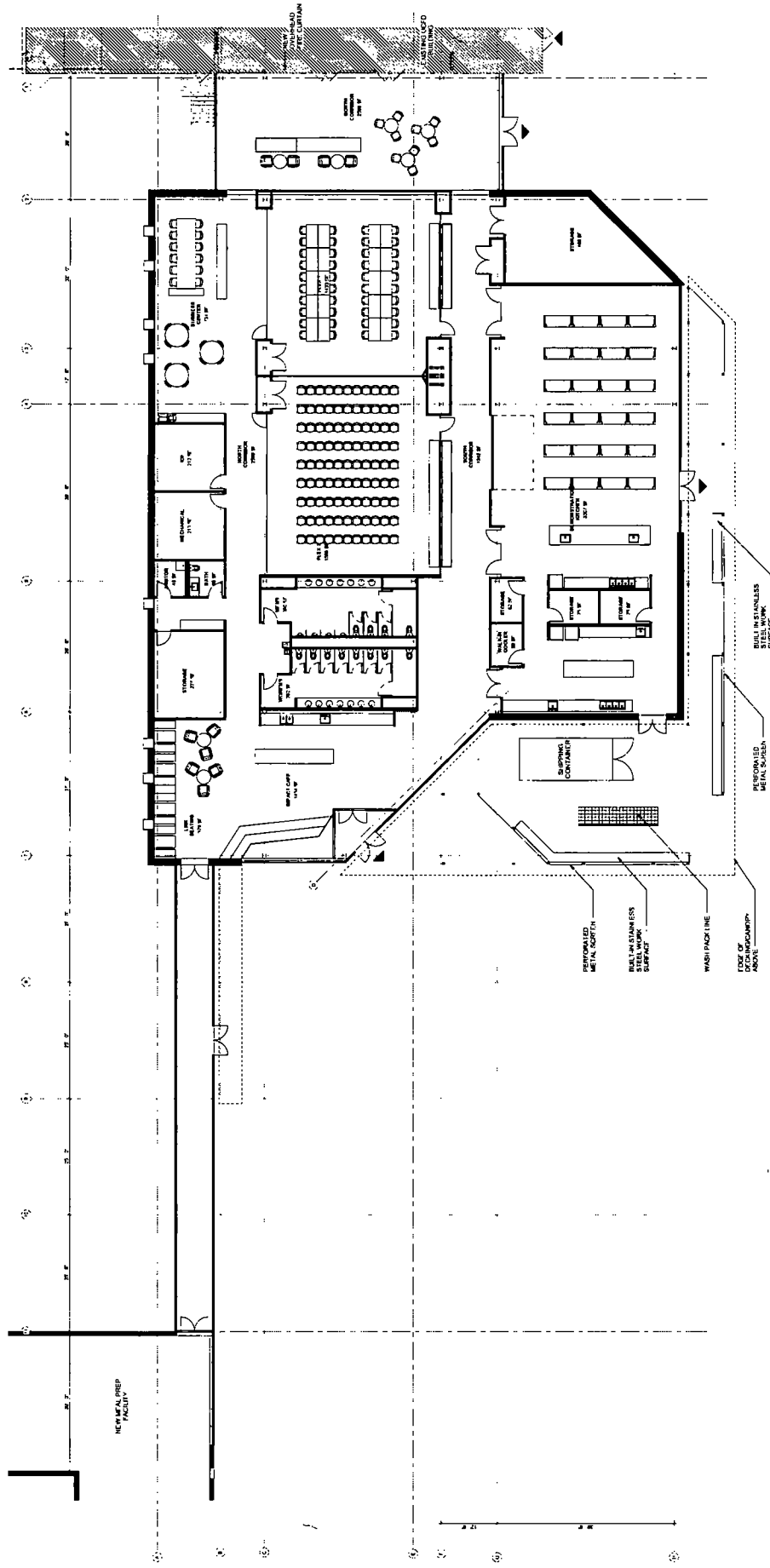

○ NORTH

APPLICANT: Greater Chicago Food Depository
ADDRESS: 4100-4230 West Ann Lurie Place / 4044-4210 South Karlov Avenue, Chicago, IL
INTRODUCED: November 13, 2019
PLAN COMMISSION: TBD

OVERALL - SOUTH ELEVATION

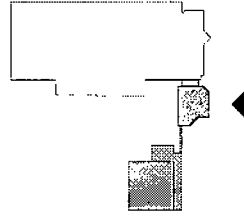
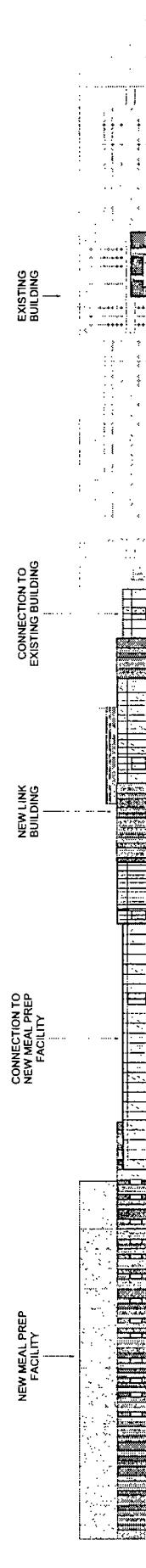

APPLICANT: Greater Chicago Food Depository
ADDRESS: 4100-4230 West Ann Lurie Place / 4044-4210 South Karlov Avenue, Chicago, IL
INTRODUCED: November 13, 2019
PLAN COMMISSION: TBD

LINK BUILDING - SOUTH ELEVATION

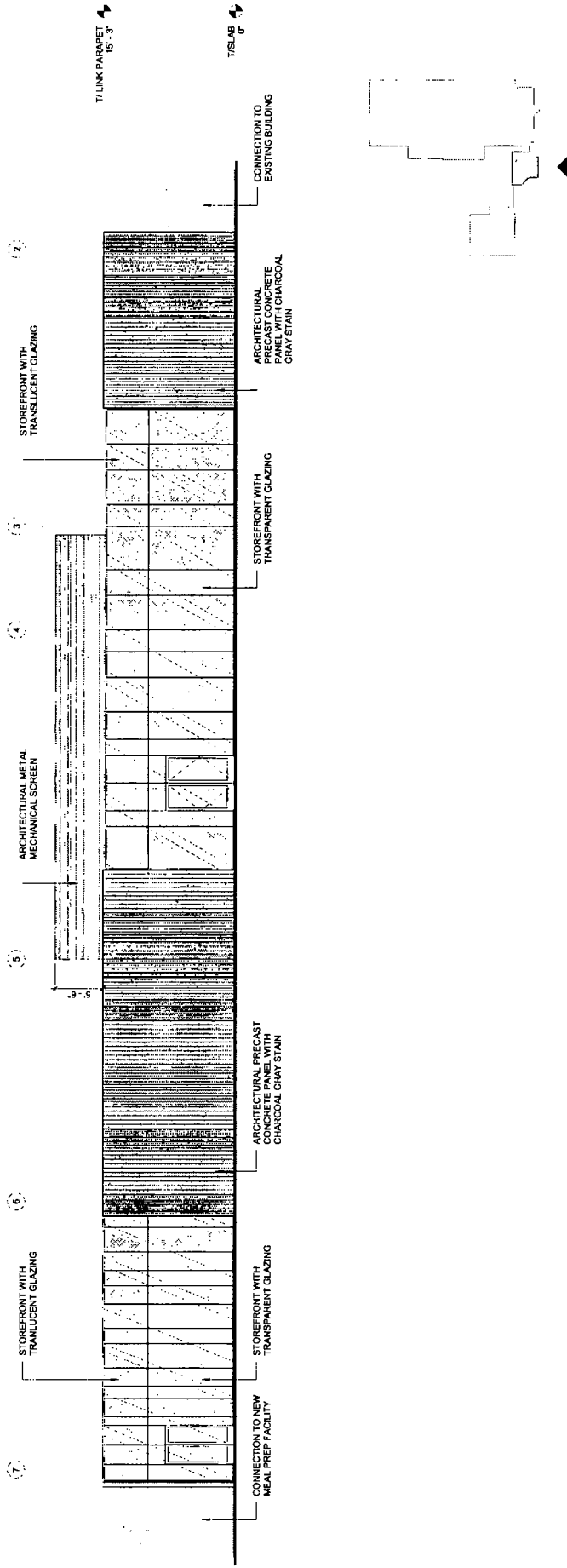

LINK BUILDING

APPLICANT: Greater Chicago Food Depository
 ADDRESS: 4100-4230 West Ann Lurie Place / 4044-4210 South Karlov Avenue, Chicago, IL
 INTRODUCED: November 13, 2019
 PLAN COMMISSION: TBD

LINK BUILDING - NORTH ELEVATION

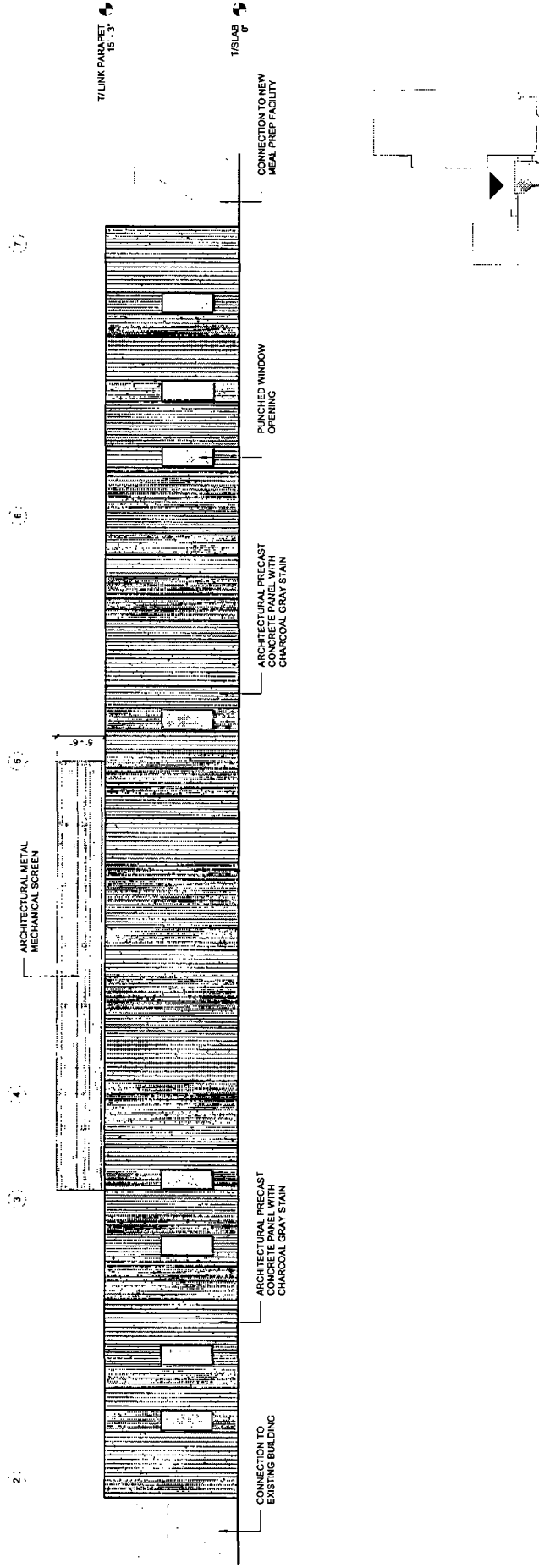

LINK BUILDING

APPLICANT: Greater Chicago Food Depository
 ADDRESS: 4100-4230 West Ann Lurie Place / 4044-4210 South Karlov Avenue, Chicago, IL
 INTRODUCED: November 13, 2019
 PLAN COMMISSION: TBD

FOOD PREP BUILDING PLAN

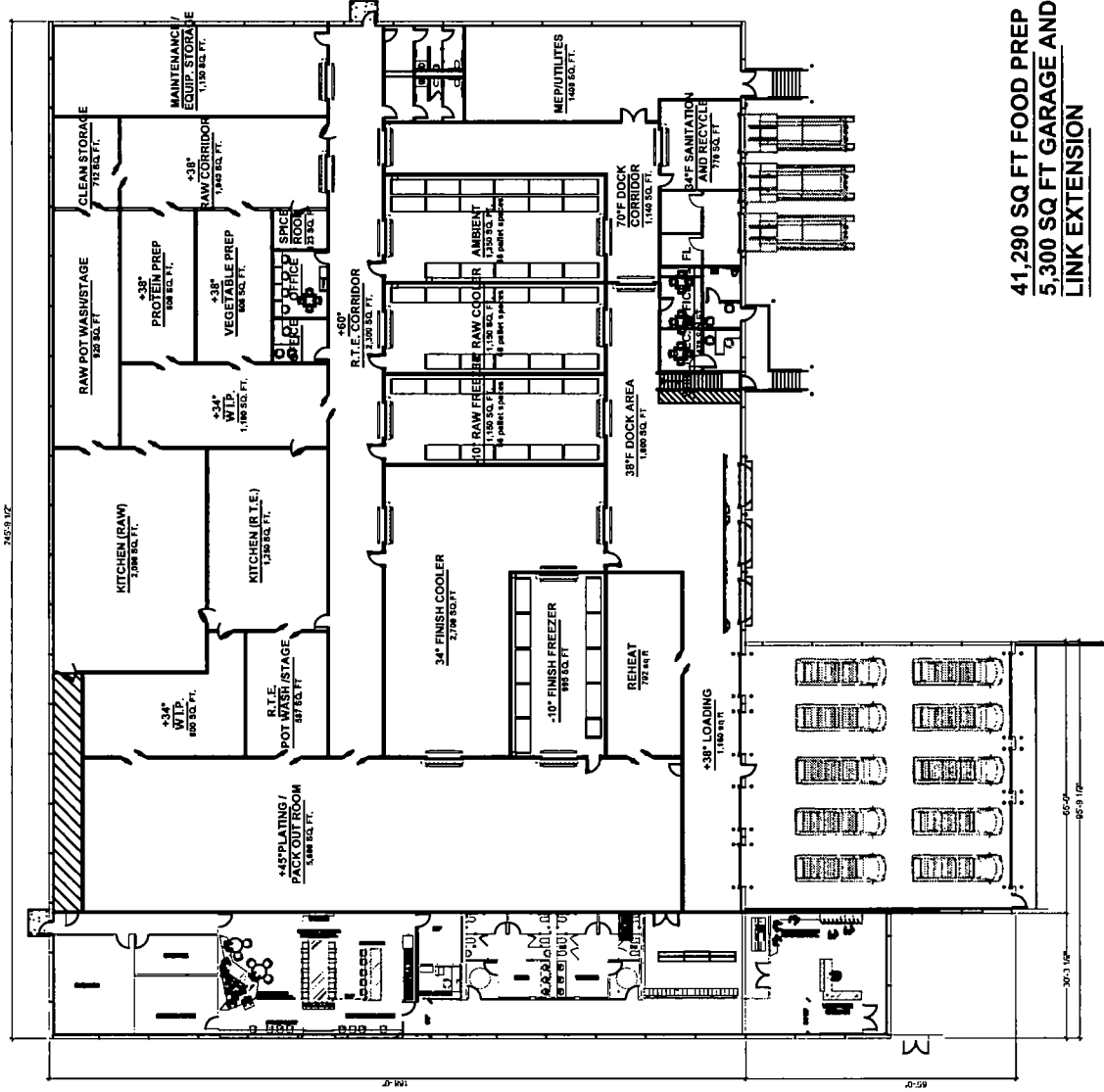

**41,290 SQ FT FOOD PREP
5,300 SQ FT GARAGE AND
LINK EXTENSION**



NORTH

APPLICANT: Greater Chicago Food Depository
ADDRESS: 4100-4230 West Ann Lane Place / 4044-4210 South Karlov Avenue, Chicago, IL
INTRODUCED: November 13, 2019
PLAN COMMISSION: TBD

PREP BUILDING - SOUTH ELEVATION

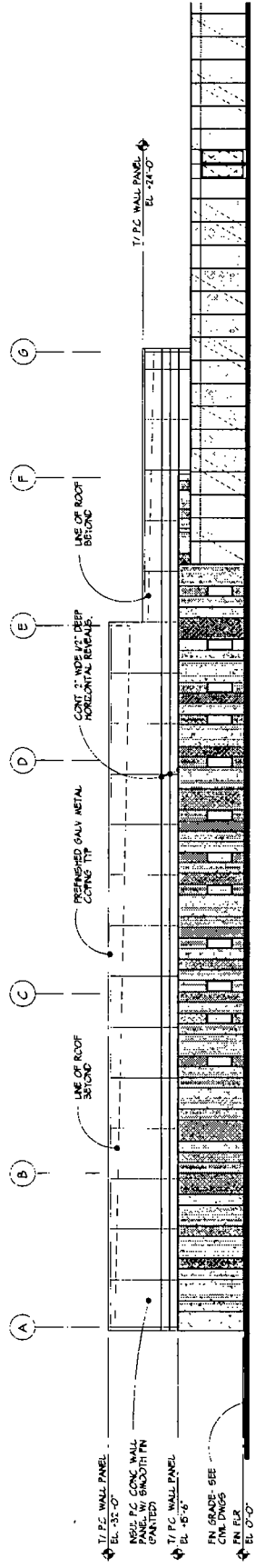

SOUTH BUILDING ELEVATION
SCALE 3/8\"/>

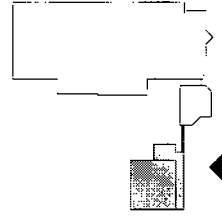

APPLICANT: Greater Chicago Food Depository
ADDRESS: 4100-4230 West Ann Lurie Place / 4044-4210 South Karlov Avenue, Chicago, IL
INTRODUCED: November 13, 2019
PLAN COMMISSION: TBD

PREP BUILDING - WEST ELEVATION

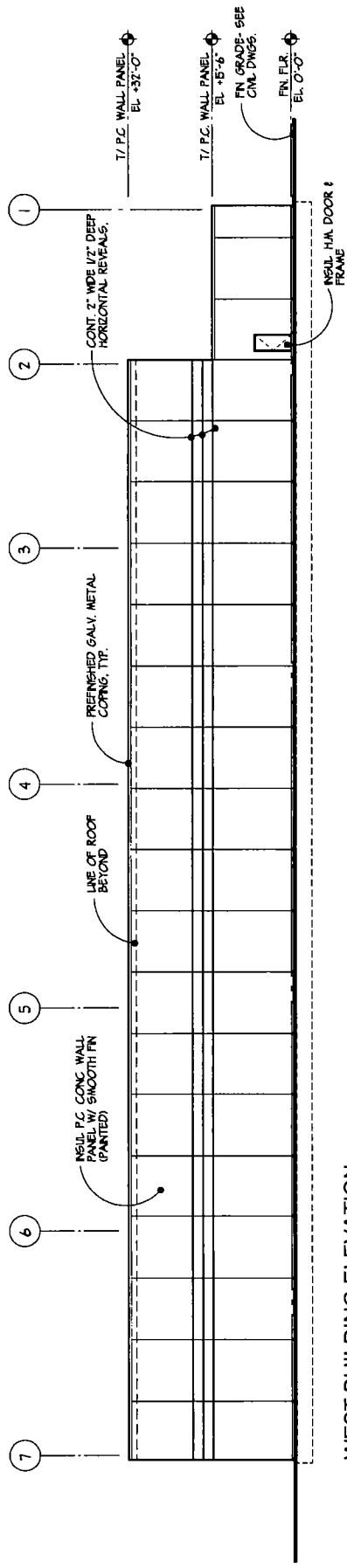

WEST BUILDING ELEVATION
SCALE 3/32"=1'-0"

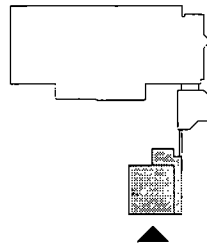

APPLICANT: Greater Chicago Food Depository
 ADDRESS: 4100-4230 West Ann Lurie Place / 4044-4210 South Karlov Avenue, Chicago, IL
 INTRODUCED: November 13, 2019
 PLAN COMMISSION: TBD

PREP BUILDING - NORTH ELEVATION

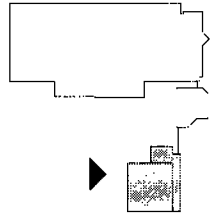
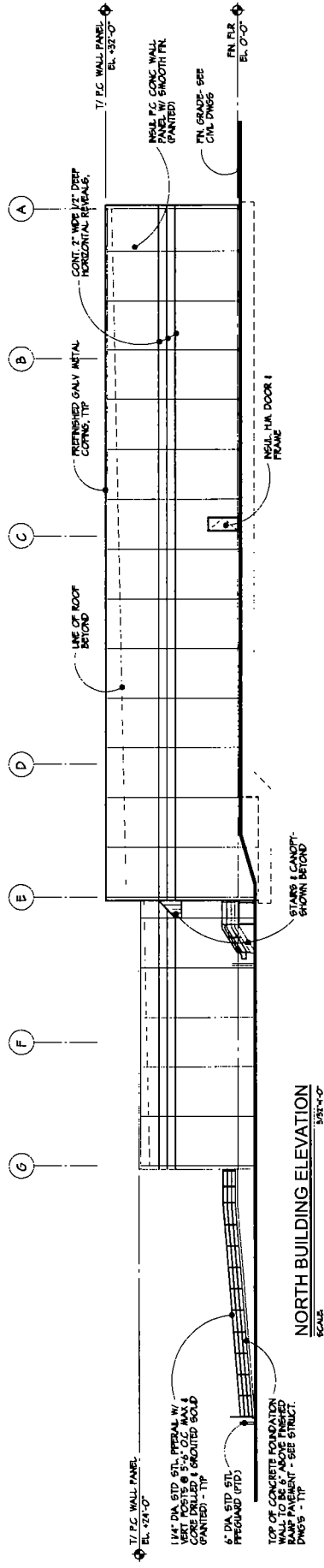

APPLICANT: Greater Chicago Food Depository
ADDRESS: 4100-4230 West Ann Lurie Place / 4044-4210 South Karlov Avenue, Chicago, IL
INTRODUCED: November 13, 2019
PLAN COMMISSION: TBD

PREP BUILDING - EAST ELEVATION

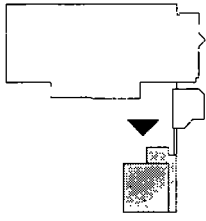
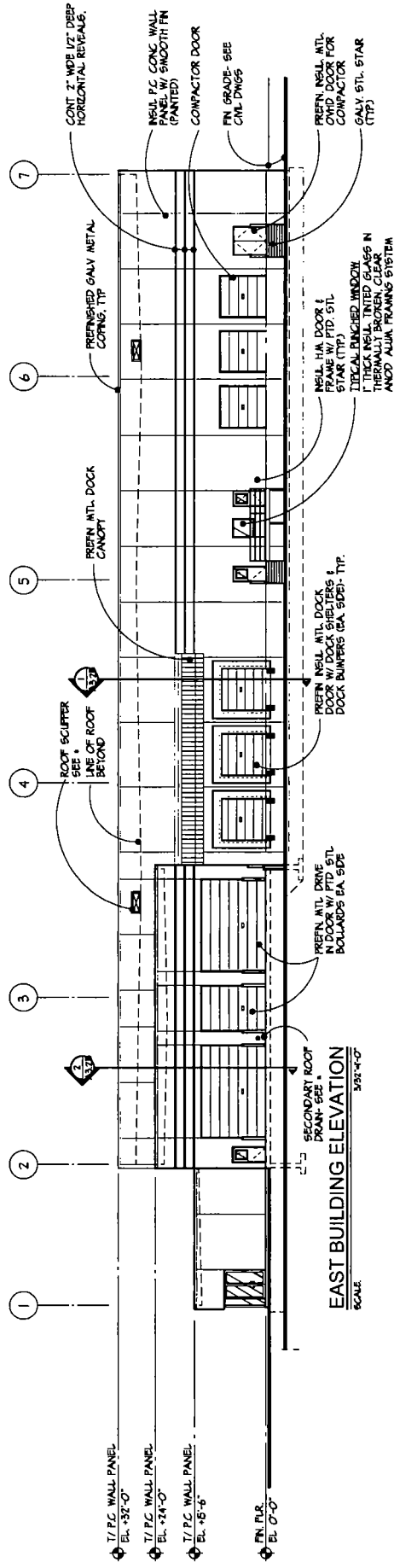

EAST BUILDING ELEVATION
SCALE: 3/8" = 1'-0"

APPLICANT: Greater Chicago Food Depository
 ADDRESS: 4100-4230 West Ann Lurie Place / 4044-4210 South Karlov Avenue, Chicago, IL
 INTRODUCED: November 13, 2019
 PLAN COMMISSION: TBD

PLAT OF SURVEY
OF

Greater Chicago Food Depository
4100 W Ann Lurie Pl, Chicago, IL

THAT PART OF LOT 8 IN CHICAGO COURT PARTITION OF THAT PART SOUTH OF THE CHICAGO RIVER OF THE 100TH WEST QUARTER IN SECTION 15, TOWNSHIP 37 NORTH, RANGE 12 EAST OF THE THIRD PRINCIPAL MERIDIAN ACCORDING TO THE PLAT OF RECORDED SURVEY IN BOOK 18, PAGE 154, CHICAGO RECORDS, WHICH SAYS IN PART: 'THAT PART OF SAID LOT 8 WHICH IS BOUND BY THE SOUTHWEST CORNER OF SAID QUARTER AND THE WEST LINE OF SAID QUARTER AND THE WEST LINE OF SAID QUARTER AND THE WEST LINE OF SAID QUARTER' AND SAID PART OF SAID LOT 8 IS SHOWN BY SAID PLAT AS BEING 100 FEET BY 100 FEET AND SAID PART OF SAID LOT 8 IS SHOWN BY SAID PLAT AS BEING 100 FEET BY 100 FEET AND SAID PART OF SAID LOT 8 IS SHOWN BY SAID PLAT AS BEING 100 FEET BY 100 FEET AND SAID PART OF SAID LOT 8 IS SHOWN BY SAID PLAT AS BEING 100 FEET BY 100 FEET

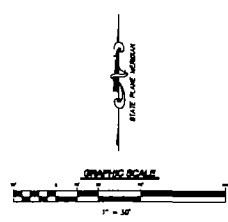
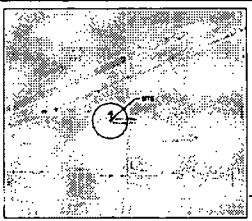

VICINITY MAP
NOT TO SCALE

AREA
0.9711 AC FT
0.38 MP ACAB

BASES OF MEASUREMENT
THE BASIS OF MEASUREMENT FOR THE LINES, CURVES, COORDINATE SYSTEMS AND ANGLES SHOWN ON THIS PLAT IS THE NATIONAL GRID SYSTEM OF 1983 WITH THE DATUM OF 1983. THE BASIS OF MEASUREMENT FOR THE DISTANCES SHOWN ON THIS PLAT IS THE NATIONAL GRID SYSTEM OF 1983 WITH THE DATUM OF 1983. ALL MEASUREMENTS ARE IN FEET AND DECIMALS THEREOF. CORRECTIONS FOR CURVATURE AND REFRACTION HAVE BEEN MADE. ALL MEASUREMENTS ARE BASED ON THE OPEN COURSE.

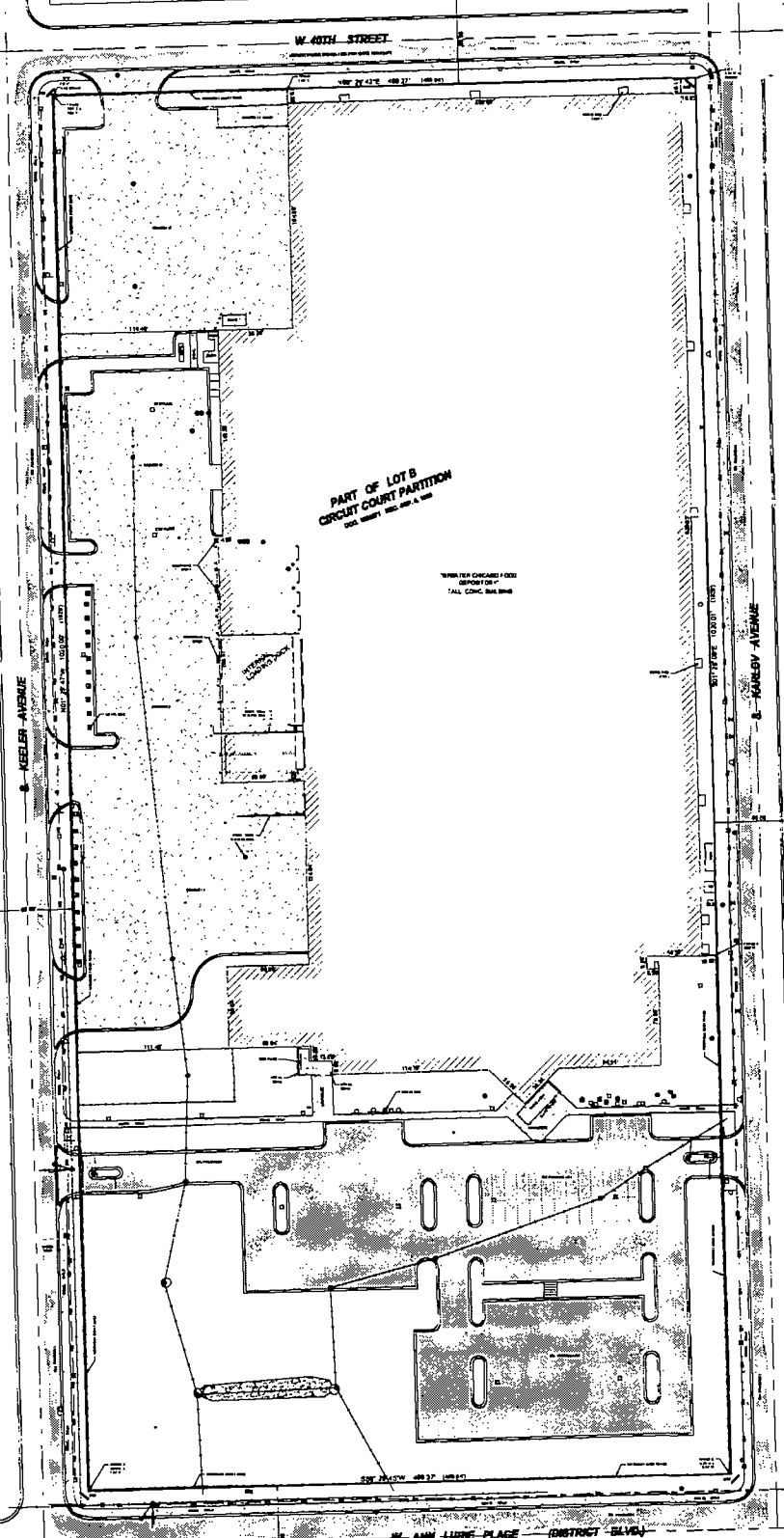

LEGEND

1. ...

2. ...

3. ...

4. ...

5. ...

6. ...

7. ...

8. ...

9. ...

10. ...

11. ...

12. ...

13. ...

14. ...

15. ...

16. ...

17. ...

18. ...

19. ...

20. ...

21. ...

22. ...

23. ...

24. ...

25. ...

26. ...

27. ...

28. ...

29. ...

30. ...

31. ...

32. ...

33. ...

34. ...

35. ...

36. ...

37. ...

38. ...

39. ...

40. ...

41. ...

42. ...

43. ...

44. ...

45. ...

46. ...

47. ...

48. ...

49. ...

50. ...

51. ...

52. ...

53. ...

54. ...

55. ...

56. ...

57. ...

58. ...

59. ...

60. ...

61. ...

62. ...

63. ...

64. ...

65. ...

66. ...

67. ...

68. ...

69. ...

70. ...

71. ...

72. ...

73. ...

74. ...

75. ...

76. ...

77. ...

78. ...

79. ...

80. ...

81. ...

82. ...

83. ...

84. ...

85. ...

86. ...

87. ...

88. ...

89. ...

90. ...

91. ...

92. ...

93. ...

94. ...

95. ...

96. ...

97. ...

98. ...

99. ...

100. ...

GENERAL NOTES

1. CONTAIN THE PLAT, LEGAL DESCRIPTION AND ALL SURVEY POINTS AND MONUMENTS BEFORE ANY CONSTRUCTION AND IMMEDIATELY REPORT ANY DISCREPANCIES TO SURVEYOR.
2. SHOW SCALE DIMENSIONS FROM THIS PLAT.
3. THE LOCATION OF THE PROPERTY LINES SHOWN ON THE FACE OF THIS PLAT ARE BASED UPON THE DESCRIPTION AND INFORMATION FURNISHED BY THE CLIENT TOGETHER WITH THE FIELD NOTES OF THE SURVEY. THE SURVEYOR HAS CONDUCTED VISUAL CHECKS OF THE ACTUAL DIMENSIONS BUT DOES NOT GUARANTEE THE ACCURACY OF THE INFORMATION FOR CONSTRUCTION PURPOSES. CONSULT YOUR TITLE COMPANY.
4. UNDERGROUND UTILITY LINES SHOWN HEREON ARE BASED ON FIELD LOCATED STRUCTURES IN CONNECTION WITH ADJACENT PROPERTIES. THE SURVEYOR HAS CONDUCTED VISUAL CHECKS OF THE UTILITY STRUCTURES AND HAS FOUND THEM TO BE IN THE GENERAL LOCATION SHOWN ON THE PLAT. THE SURVEYOR DOES NOT GUARANTEE THE LOCATION OR DEPTH OF ANY UTILITY STRUCTURES SHOWN HEREON.
5. THE SURVEYOR HAS NOT CONDUCTED VISUAL CHECKS OF ANY UTILITY STRUCTURES SHOWN HEREON. THE SURVEYOR HAS NOT CONDUCTED VISUAL CHECKS OF ANY UTILITY STRUCTURES SHOWN HEREON.
6. THE SURVEYOR HAS NOT CONDUCTED VISUAL CHECKS OF ANY UTILITY STRUCTURES SHOWN HEREON. THE SURVEYOR HAS NOT CONDUCTED VISUAL CHECKS OF ANY UTILITY STRUCTURES SHOWN HEREON.
7. THE SURVEYOR HAS NOT CONDUCTED VISUAL CHECKS OF ANY UTILITY STRUCTURES SHOWN HEREON. THE SURVEYOR HAS NOT CONDUCTED VISUAL CHECKS OF ANY UTILITY STRUCTURES SHOWN HEREON.
8. THE SURVEYOR HAS NOT CONDUCTED VISUAL CHECKS OF ANY UTILITY STRUCTURES SHOWN HEREON. THE SURVEYOR HAS NOT CONDUCTED VISUAL CHECKS OF ANY UTILITY STRUCTURES SHOWN HEREON.
9. THE SURVEYOR HAS NOT CONDUCTED VISUAL CHECKS OF ANY UTILITY STRUCTURES SHOWN HEREON. THE SURVEYOR HAS NOT CONDUCTED VISUAL CHECKS OF ANY UTILITY STRUCTURES SHOWN HEREON.
10. THE SURVEYOR HAS NOT CONDUCTED VISUAL CHECKS OF ANY UTILITY STRUCTURES SHOWN HEREON. THE SURVEYOR HAS NOT CONDUCTED VISUAL CHECKS OF ANY UTILITY STRUCTURES SHOWN HEREON.
11. THE SURVEYOR HAS NOT CONDUCTED VISUAL CHECKS OF ANY UTILITY STRUCTURES SHOWN HEREON. THE SURVEYOR HAS NOT CONDUCTED VISUAL CHECKS OF ANY UTILITY STRUCTURES SHOWN HEREON.
12. THE SURVEYOR HAS NOT CONDUCTED VISUAL CHECKS OF ANY UTILITY STRUCTURES SHOWN HEREON. THE SURVEYOR HAS NOT CONDUCTED VISUAL CHECKS OF ANY UTILITY STRUCTURES SHOWN HEREON.
13. THE SURVEYOR HAS NOT CONDUCTED VISUAL CHECKS OF ANY UTILITY STRUCTURES SHOWN HEREON. THE SURVEYOR HAS NOT CONDUCTED VISUAL CHECKS OF ANY UTILITY STRUCTURES SHOWN HEREON.
14. THE SURVEYOR HAS NOT CONDUCTED VISUAL CHECKS OF ANY UTILITY STRUCTURES SHOWN HEREON. THE SURVEYOR HAS NOT CONDUCTED VISUAL CHECKS OF ANY UTILITY STRUCTURES SHOWN HEREON.
15. THE SURVEYOR HAS NOT CONDUCTED VISUAL CHECKS OF ANY UTILITY STRUCTURES SHOWN HEREON. THE SURVEYOR HAS NOT CONDUCTED VISUAL CHECKS OF ANY UTILITY STRUCTURES SHOWN HEREON.
16. THE SURVEYOR HAS NOT CONDUCTED VISUAL CHECKS OF ANY UTILITY STRUCTURES SHOWN HEREON. THE SURVEYOR HAS NOT CONDUCTED VISUAL CHECKS OF ANY UTILITY STRUCTURES SHOWN HEREON.
17. THE SURVEYOR HAS NOT CONDUCTED VISUAL CHECKS OF ANY UTILITY STRUCTURES SHOWN HEREON. THE SURVEYOR HAS NOT CONDUCTED VISUAL CHECKS OF ANY UTILITY STRUCTURES SHOWN HEREON.
18. THE SURVEYOR HAS NOT CONDUCTED VISUAL CHECKS OF ANY UTILITY STRUCTURES SHOWN HEREON. THE SURVEYOR HAS NOT CONDUCTED VISUAL CHECKS OF ANY UTILITY STRUCTURES SHOWN HEREON.
19. THE SURVEYOR HAS NOT CONDUCTED VISUAL CHECKS OF ANY UTILITY STRUCTURES SHOWN HEREON. THE SURVEYOR HAS NOT CONDUCTED VISUAL CHECKS OF ANY UTILITY STRUCTURES SHOWN HEREON.
20. THE SURVEYOR HAS NOT CONDUCTED VISUAL CHECKS OF ANY UTILITY STRUCTURES SHOWN HEREON. THE SURVEYOR HAS NOT CONDUCTED VISUAL CHECKS OF ANY UTILITY STRUCTURES SHOWN HEREON.

SURVEYOR'S CERTIFICATE

STATE OF ILLINOIS)
COUNTY OF DUKE)

I, CHRISTOPHER D. SHIPLEY, AN ELIGIBLE PROFESSIONAL LAND SURVEYOR, HEREBY CERTIFY THAT I HAVE SURVEYED THE ABOVE DESCRIBED PROPERTY AND THAT THE PLAT IS A TRUE AND CORRECT REPRESENTATION THEREOF. ALL MEASUREMENTS ARE MADE IN FEET AND DECIMALS THEREOF. CORRECTED TO THE NATIONAL GRID SYSTEM OF 1983 WITH THE DATUM OF 1983.
THE PROFESSIONAL SERVICE CONFORMS TO THE CURRENT ILLINOIS SURVEYING ACT AND RULES FOR SURVEYING SURVEYS.
FIELD WORK COMPLETED ON OCTOBER 1, 2018
DATED THIS 20th DAY OF OCTOBER A.D. 2018

Christopher D. Shipley
Professional Land Surveyor No. 183-088
1171 Lakeshore Drive, Suite 300
Chicago, IL 60606
The Original Survey Record Available at:
www.dps.state.il.us



Engineers
Surveyors
3733 James Avenue, Suite 100
Woodridge, IL 60517
630 724 9200 voice
630 724 9336 fax
v3co.com

Prepared by:
Petersen by Design
360 West Erie Street, Suite 800
Chicago, IL 60610
312.648.1111

NO.	DATE	DESCRIPTION	NO.	DATE	DESCRIPTION

PLAT OF SURVEY
Greater Chicago Food Depository - 4100 W Ann Lurie Pl, Chicago, IL
Project No. 1723.1
Sheet No. 003.1
Drawing Date 10/1/18
Field Work Completed 10/1/18
Checked by: [Signature]
Scale: 1" = 30'

VACATION OF PORTION OF S. KEELER AVE., BETWEEN W. 40TH ST. AND
W. DISTRICT BLVD.

[O2019-5742]

The Committee on Transportation and Public Way submitted the following report:

CHICAGO, September 18, 2019.

To the President and Members of the City Council:

Your Committee on Transportation and Public Way begs leave to report and recommend that Your Honorable Body *Pass* the proposed ordinance transmitted herewith for a proposed vacation of South Keeler Avenue, between West District Boulevard and West 40th Street. This ordinance was referred to the committee on July 24, 2019.

This recommendation was concurred in unanimously by a viva voce vote of the members of the committee, with no dissenting vote.

Respectfully submitted,

(Signed) HOWARD BROOKINS, JR.,
Chairman.

On motion of Alderman Brookins, the said proposed ordinance transmitted with the foregoing committee report was *Passed* by yeas and nays as follows:

Yeas -- Aldermen La Spata, Hopkins, Dowell, King, Hairston, Sawyer, Mitchell, Harris, Beale, Sadlowski Garza, Thompson, Cárdenas, Quinn, Burke, Lopez, Coleman, Moore, Curtis, O'Shea, Taylor, Brookins, Rodriguez, Tabares, Scott, Sigcho-Lopez, Maldonado, Burnett, Ervin, Taliaferro, Reboyras, Cardona, Waguespack, Rodriguez-Sanchez, Austin, Ramirez-Rosa, Villegas, Mitts, Sposato, Nugent, Vasquez, Napolitano, Reilly, Smith, Tunney, Gardiner, Cappleman, Martin, Osterman, Hadden, Silverstein -- 50.

Nays -- None.

Alderman Thompson moved to reconsider the foregoing vote. The motion was lost.

The following is said ordinance as passed:

WHEREAS, The City of Chicago ("City") is a home rule unit of local government pursuant to Article VII, Section 6(a) of the 1970 Constitution of the State of Illinois and, as such, may exercise any power and perform any function pertaining to its government and affairs; and

WHEREAS, The City wishes to support the charitable, educational and philanthropic activities of established not-for-profit corporations and encourage the continued viability and growth of such activities; and

WHEREAS, Many not-for-profit corporations own property that adjoins streets and alleys that are no longer required for public use and might more productively be used in furtherance of such activities; and

WHEREAS, The City would benefit from the vacation of these streets and alleys by reducing City expenditures on maintenance, repair and replacement; by reducing fly-dumping, vandalism and other criminal activity; and by providing support for such charitable, educational and philanthropic activities; and

WHEREAS, The City can promote strong communities by facilitating services to the public, and increase the City's job base through the vacation of public way for no compensation; and

WHEREAS, The properties at 4044 -- 4210 South Keeler Avenue and 4045 -- 4211 South Keeler Avenue are owned by Greater Chicago Food Depository, an Illinois not-for-profit corporation ("Developer"); and

WHEREAS, The Developer proposes to use the portion of the public street to be vacated herein for a connection between their existing plant and a new meal preparation facility, a demonstration garden and accessory parking; and

WHEREAS, The City Council of the City, after due investigation and consideration, has determined that the nature and extent of the public use and the public interest to be subserved is such as to warrant the vacation of parts of the public street described in this ordinance; now, therefore,

Be It Ordained by the City Council of the City of Chicago:

SECTION 1. Vacation of that part of South Keeler Avenue, 66-foot wide right-of-way, in the east half of the northeast quarter of Section 3, Township 38 North, Range 13, East of the Third Principal Meridian, as dedicated per Document Number 92443410, recorded June 18, 1992; said part of South Keeler Avenue is bound to the north by the south right-of-way line of West 40th Street and bound to the south by the north right-of-way line of West District Boulevard (also known as West Ann Lurie Place), all in Cook County, Illinois, said above described parcel containing 67,320 square feet or 1.545 acres, more or less, as shaded and legally described by the words "Hereby Vacated" on the plat hereto attached as Exhibit A, which drawing for greater clarity, is hereby made a part of this ordinance, be and the same is hereby vacated and closed, inasmuch as the same is no longer required for public use and the public interest will be subserved by such vacation.

SECTION 2. The Commissioner of the Chicago Department of Transportation is hereby authorized to accept and approve a redevelopment agreement or similar instrument restricting the use and improvement of the public way vacated in Section 1 of this

ordinance to social service purposes which include, but shall not be limited to, the processing, preparation and charitable distribution of foodstuffs, and for such use and improvements that are accessory, as that term is defined in the Chicago Zoning Ordinance, to such social service purposes, such uses and improvements to be owned and operated by a not-for-profit corporation, subject to the approval of the Corporation Counsel as to form and legality. The restriction on use and improvement in the redevelopment agreement or similar instrument shall be for a term of forty (40) years and upon breach of such restriction the public way herein vacated shall revert to the City and be subject to the terms and conditions of the dedication by which it has been heretofore held by the City.

SECTION 3 The vacation herein provided is made upon the express condition that the Developer abandon, at its sole cost and expense, the (i) one 8-inch water main ("Water Main") within the to be vacated area that was installed in 1940; (ii) three fire hydrants; (iii) two 6-inch valves; (iv) two 8-inch valves; and (v) three 12-inch valves, all associated with the Water Main and subject to the conditions memorialized in the Chicago Department of Water Management's June 27, 2019 letter ("Water Department's June 27, 2019 Letter") attached hereto and made a part hereof as Exhibit B.

SECTION 4. The vacation herein provided is made upon the express condition that, subject to the conditions memorialized in the Water Department's June 27, 2019 Letter, attached hereto and made a part hereof as Exhibit B, the Developer shall (1) maintain as private sewers, at its sole cost and expense, the one 15-inch sewer main and appurtenances on South Keeler Avenue extending from West 40th Street approximately 92 feet south; and the one 15-inch to 21-inch sewer main and appurtenances on South Keeler Avenue extending from West Ann Lurie Place approximately 756 feet; and (2) that the to be vacated shall be subject to the Chicago Stormwater Regulation requirements upon development; and (3) any Developer abandonment of the sewer facilities on South Keeler Avenue must (i) meet the Sewer Section's requirements; and (ii) any abandonment must be approved by the Sewer Section all at the Developer's sole cost and expense.

SECTION 5. The City hereby reserves for the benefit of Commonwealth Edison and AT&T/SBC, and their successors or assigns, a non-exclusive utility easement to operate, maintain, construct, replace and renew overhead wires, poles, and associated equipment and underground conduit, cables, and associated equipment for the transmission and distribution of electrical energy, and for telephonic and associated services, under, over and along the street herein vacated, with the right of ingress and egress. The grade of the vacated public way shall not be altered in a manner so as to interfere with the operation and maintenance of Commonwealth Edison and/or AT&T/SBC facilities. No construction, buildings, permanent structures or obstructions shall occur or be placed over the area herein vacated without the express written release of easement by the aforementioned involved utility(ies). Any future relocation of facilities lying within the area herein vacated that is requested or necessitated by the Developer or its successors or assigns will be accomplished by the involved utility, and be done at the expense of the Developer, its successors or assigns.

SECTION 6. The vacation herein provided for is made upon the express condition that within 180 days after the passage of this ordinance, the Developer shall deposit in the City Treasury of the City, a sum sufficient to defray the costs of removing paving and curb returns, and constructing sidewalk in accordance with the most current version of the Chicago Department of Transportation's Regulations for Opening, Repair and Construction in the Public Way and its appendices.

SECTION 7. The vacation herein provided for is made upon the express condition that within 180 days after the passage of this ordinance the Developer shall file or cause to be filed in the Office of the Recorder of Deeds of Cook County, Illinois, a certified copy of this ordinance, together with a redevelopment agreement or similar instrument complying with Section 2 of this ordinance, and approved by the Corporation Counsel, and the attached plat as approved by the Superintendent of Maps and Plats.

SECTION 8. This ordinance shall take effect and be in force from and after its passage and publication. The vacation and plat shall take effect and be in force from and after their recording.

Vacation Approved:

(Signed) Thomas Carney
Acting Commissioner of
Transportation

Approved as to Form and Legality:

(Signed) Arthur Dolinsky
Senior Counsel

Introduced By:

(Signed) Edward M. Burke
Alderman, 14th Ward

[Exhibit "A" referred to in this ordinance printed on
pages 6155 and 6156 of this *Journal*.]

Exhibit "B" referred to in this ordinance reads as follows:

Exhibit "B".

DEPARTMENT OF WATER MANAGEMENT
CITY OF CHICAGO

June 27, 2019

City of Chicago
Department of Transportation
Division of Infrastructure Management
Office of Underground Coordination
30 North LaSalle Street, 3rd Floor
Chicago, Illinois 60602

Attn: Mr. Jai Kalayil
Coordinator of Street Permits

Re: Proposed NFP Vacation Ordinance
14th Ward
For: Greater Chicago Food Depository

S. Keeler Avenue between W. 40th Street and W. Ann Lurie Place
(AKA W. District Boulevard)

OUC File No. 2019-87030
M&P Project No. 03-14-19-3896
Water Atlas Page 390
Sewer Atlas Page 38-3-65

Dear Mr. Kalayil:

This letter is in response to your inquiry dated March 22, 2019 concerning the proposed vacation. After reviewing our records, we have determined the following:

I) The Department of Water Management - Water Section

There is one 8-inch water main within the proposed vacation that was installed in 1940. There are also three fire hydrants, two 6-inch valves, two 8-inch valves and three 12-inch valves associated with this main.

These facilities must be abandoned at the owner's expense for the vacation to be approved by the Water Section, subject to the following conditions:

- a. Disconnecting the water main to be abandoned at W. 40th Street and at W. Ann Lurie Place, removing all three fire hydrants and abandoning the valve basins outside of the proposed vacation will be done by the Department of Water Management (DWM) at the owner's expense. Removal of the four valve basins within the proposed vacation are the responsibility of the owner.
- b. The DWM will perform the excavation, pipe work and backfilling to grade associated with the work described above. The owner will be responsible for obtaining all applicable permits and all restoration to CDOT standards.
- c. The estimated cost to do this work is \$40,800.00. This estimate is based on current rates for labor, materials, equipment and overhead charges, but actual costs will be billed to the owner upon DWM's completion of the work.

- d. The existing water main is not fully amortized. The total fixed unamortized cost for this water main is \$641.03.
- e. All water services no longer in use must be permanently terminated as part of the proposed development by permit per DWM Standards.
- f. Because the existing water main cannot be located within private property (the proposed vacation), this work must be done before the vacation can be approved.
- g. Detailed instructions for payment of the estimated cost of \$40,800.00 and the fixed unamortized cost of \$641.03 will follow under separate cover.

For questions regarding water facilities, please contact Andrew McFarland at (312) 742-7027.

II) **The Department of Water Management - Sewer Section**

The following sewer facilities are within the proposed vacation:

- a. One 15" public sewer main and appurtenances on S. Keeler Avenue extending from W. 40th Street approximately 92 feet south.
- b. One 15" to 21" public sewer main and appurtenances on S. Keeler Avenue extending from W. Ann Lurie Place approximately 756 feet north.

The Sewer Section has no objections to the proposed vacation, provided the following are part of the vacation ordinance:

- 1. The existing 15" public sewer main and appurtenances on S. Keeler Avenue extending south from W. 40th Street must become a private sewer maintained by the owner.
- 2. The existing 15" to 21" public sewer main and appurtenances on S. Keeler Avenue extending north from W. Ann Lurie Place must become a private sewer maintained by the owner.
- 3. The area to be vacated will be subject to the Stormwater Regulation requirements upon development.
- 4. If the owner wants to abandon any of the sewer facilities on S. Keeler Avenue, the abandonment plans must meet the Sewer Section's requirements. Abandonment of these facilities must be approved by the Sewer Section and installed at the owner's expense.

For questions regarding sewer facilities, please contact Anupam Verma at (312) 742-7108 or Sid Osakada at (312) 744-0344.

Very truly yours,



Randy Conner
Commissioner

Exhibit "A".
(Page 2 of 2)

PLAT OF VACATION

PROPERTY DESCRIPTION

THAT PART OF S. KEELER AVENUE 66 FOOT WIDE RIGHT OF WAY IN THE EAST HALF OF THE NORTHEAST QUARTER OF SECTION 3, TOWNSHIP 38 NORTH, RANGE 13, EAST OF THE THIRD PRINCIPLE MERIDIAN, AS DEDICATED PER DOCUMENT NUMBER 92443410, RECORDED JUNE 18, 1992; SAID PART OF S. KEELER AVENUE IS BOUND TO THE NORTH BY THE SOUTH RIGHT OF WAY LINE OF W. 40TH STREET AND BOUND TO THE SOUTH BY THE NORTH RIGHT OF WAY LINE OF W. DISTRICT BOULAVARD (AKA W. ANN LURIE PLACE), ALL IN COOK COUNTY, ILLINOIS, SAID ABOVE DESCRIBED PARCEL CONTAINING 67,320 SQUARE FEET OR 1.545 ACRES, FEET MORE OR LESS.

STATE OF ILLINOIS)
COUNTY OF COOK) SS

WE, SPACED, INC., AN ILLINOIS PROFESSIONAL DESIGN FIRM, NUMBER 184-00117 (EXPIRATION DATE 04/30/2021) DO HEREBY DECLARE THAT WE HAVE PREPARED THE PLAT HEREON DRAWN FOR THE PURPOSE OF VACATING A PUBLIC STREET AS SHOWN, AND THAT THE PLAT IS A TRUE AND CORRECT REPRESENTATION OF SAID VACATION.

ALL DIMENSIONS ARE IN FEET AND DECIMAL PARTS THEREOF. NO DISTANCES OR ANGLES SHOWN HEREON MAY BE ASSUMED BY SCALING.

THIS PROFESSIONAL SERVICE CONFORMS TO THE CURRENT ILLINOIS MINIMUM STANDARDS FOR A BOUNDARY SURVEY.

I HEREBY AUTHORIZE _____ OR THEIR AGENT TO FILE THIS PLAT OF VACATION WITH THE COOK COUNTY RECORDER'S OFFICE.

GIVEN UNDER OUR HAND AND SEAL THIS 16TH DAY OF JULY, 2019 IN ROSEMONT, ILLINOIS.

Gamela Ptasinska
GAMELA PTASINSKA, I.P.S., No. 033-1893
LICENSE EXPIRES 11-30-2020
2010 BIRN ILLINOIS 800106.COM

VALID ONLY IF EMBOSSED SEAL AFFIXED

COMPARE ALL DIMENSIONS BEFORE BUILDING AND REPORT ANY DISCREPANCIES AT ONCE. REFER TO SAID OR TITLE POLICY FOR BUILDING LINES AND EASEMENTS.

CDOT# 03-14-19-3896

SHEET: 2 OF 2

REVISION	DATE
07/11/2019	02/22/2019
07/16/2019	

N
 SCALE: N/A

SPACED INC.

CONTRACT NUMBER	DATE
15050000000000000000	02/22/2019
PROJECT NUMBER	JOB NO.
	10283
	FEEDBACK
	146-31

9575 W. Higgins Road, Suite 700 Rosemont, Illinois 60018 Phone: (847) 595-4262 Fax: (847) 676-4065	
--	--

4. V:\mch\128\NEWS\PTASINSKA\AC 01.dwg Detail User:masa

EXHIBIT "A"

PLAT OF VACATION

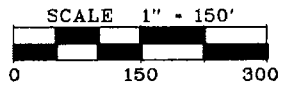

ADJACENT PINS
19-03-200-018
19-03-201-033
19-03-201-017

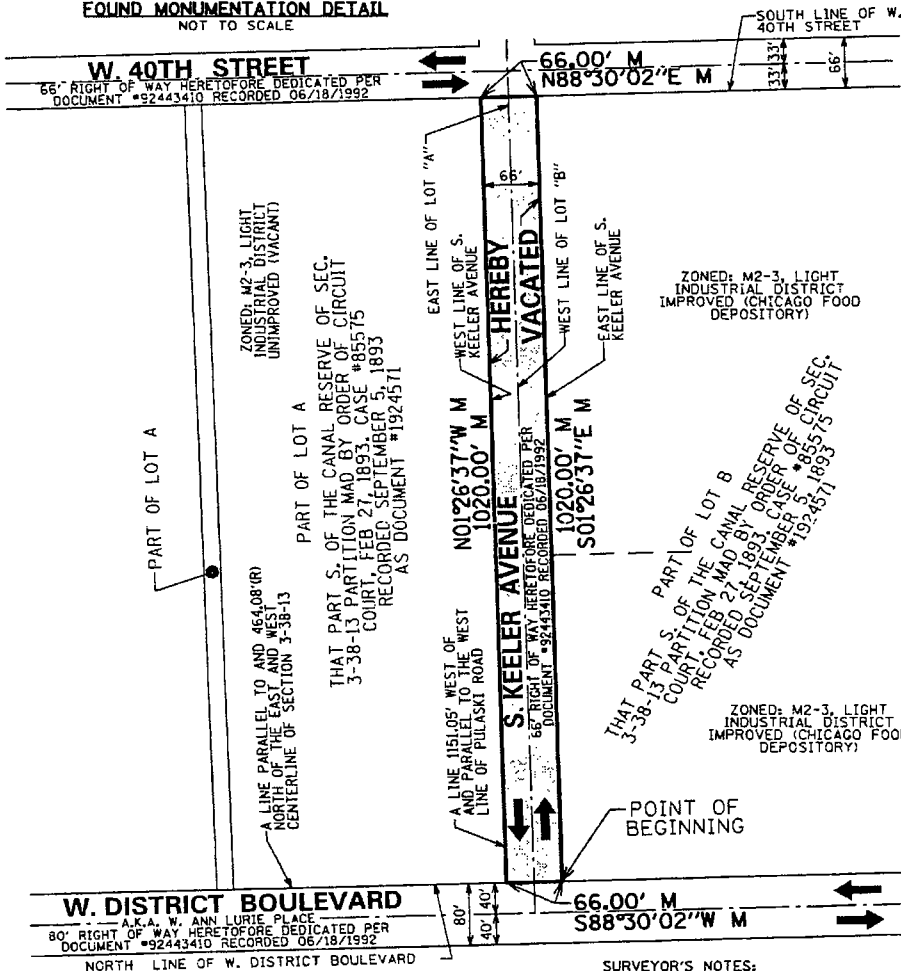
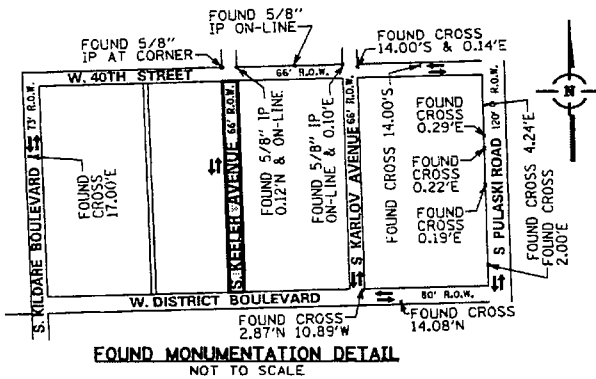

PART OF LOT A

ZONED: M2-3, LIGHT INDUSTRIAL DISTRICT UNIMPROVED (VACANT)

PART OF LOT A

THAT PART S. OF THE CANAL RESERVE OF SEC. 3-38-13 PARTITIONED BY ORDER OF CIRCUIT COURT, FEB. 27, 1893, CASE #85575 RECORDED SEPTEMBER 5, 1893 AS DOCUMENT #1924571

EAST LINE OF LOT "A"

WEST LINE OF S. KEELER AVENUE

HEREBY VACATED

WEST LINE OF LOT "B"

EAST LINE OF S. KEELER AVENUE

ZONED: M2-3, LIGHT INDUSTRIAL DISTRICT IMPROVED (CHICAGO FOOD DEPOSITORY)

PART OF LOT B

THAT PART S. OF THE CANAL RESERVE OF SEC. 3-38-13 PARTITIONED BY ORDER OF CIRCUIT COURT, FEB. 27, 1893, CASE #85575 RECORDED SEPTEMBER 5, 1893 AS DOCUMENT #1924571

ZONED: M2-3, LIGHT INDUSTRIAL DISTRICT IMPROVED (CHICAGO FOOD DEPOSITORY)

POINT OF BEGINNING

W. DISTRICT BOULEVARD

AKA: W. ANN LURIE PLACE
80' RIGHT OF WAY HERETOFORE DEDICATED PER DOCUMENT #92443410 RECORDED 06/18/1992

NORTH LINE OF W. DISTRICT BOULEVARD

SURVEYOR'S NOTES:

1. ALL DIMENSIONS SHOWN HEREON ARE MEASURED UNLESS NOTED.
2. BASIS OF BEARINGS: TRUE NORTH BASED ON GEODETIC OBSERVATION IL EAST ZONE.
3. NO DIMENSIONS SHOULD BE ASSUMED BY SCALE MEASUREMENTS UPON THE PLAT.
4. PREPARED FOR/AND MAIL TO: JLL, PROJECT AND DEVELOPMENT SERVICES 8755 WEST HIGGINS ROAD, SUITE 750 CHICAGO, IL 60631
5. LAST DATE OF FIELD WORK: DECEMBER 4, 2018
6. CURRENT ZONING: M2-3; LIGHT INDUSTRIAL DISTRICT

LEGEND

- BOUNDARY LINE
- EXISTING RIGHT-OF-WAY OR LOT LINE
- (00.00'R) = RECORD
- 00.00'M = MEASURED
- TRAFFIC FLOW DIRECTION
- PUBLIC RIGHT OF WAY HEREBY VACATED

CDOT# 03-14-19-3896

SHEET: 1 OF 3

REVISIONS:
07/12/2019
07/16/2019

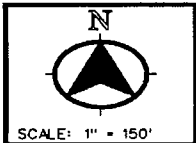

CONSULTING ENGINEERS
SITE DEVELOPMENT ENGINEERS
LAND SURVEYORS

9575 W Higgins Road, Suite 700, Rosemont, Illinois 60018
Phone: (847) 696-4060 Fax: (847) 696-4065

DATE:	02/22/2019
JOB NO:	10283
FILENAME:	VAC-01

PLAT OF VACATION

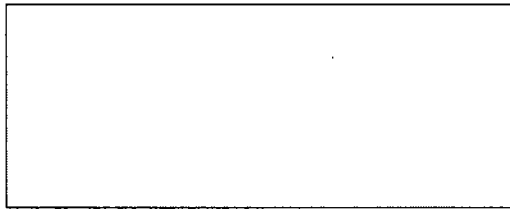

COOK CO.

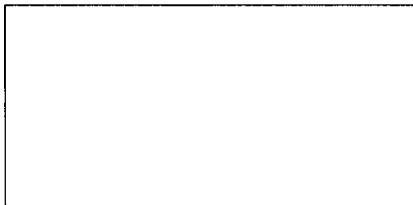

CITY - DEPARTMENT OF FINANCE

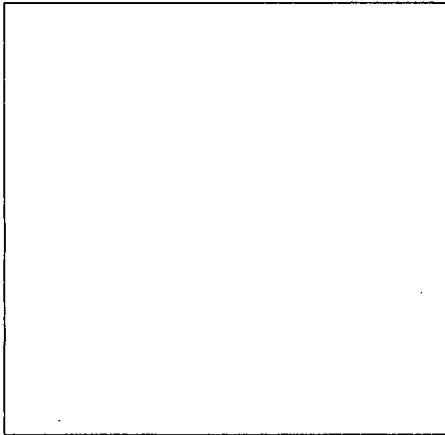

CDOT

PROPERTY DESCRIPTION

THAT PART OF S. KEELER AVENUE 66 FOOT WIDE RIGHT OF WAY IN THE EAST HALF OF THE NORTHEAST QUARTER OF SECTION 3, TOWNSHIP 38 NORTH, RANGE 13, EAST OF THE THIRD PRINCIPLE MERIDAIN, AS DEDICATED PER DOCUMENT NUMBER 92443410, RECORDED JUNE 18, 1992; SAID PART OF S. KEELER AVENUE IS BOUND TO THE NORTH BY THE SOUTH RIGHT OF WAY LINE OF W. 40TH STREET AND BOUND TO THE SOUTH BY THE NORTH RIGHT OF WAY LINE OF W. DISTRICT BOULAVARD (AKA W. ANN LURIE PLACE), ALL IN COOK COUNTY, ILLINOIS, SAID ABOVE DESCRIBED PARCEL CONTANING 67,320 SQUARE FEET OR 1.545 ACRES, FEET MORE OR LESS.

STATE OF ILLINOIS)
COUNTY OF COOK) SS

WE, SPACECO, INC., AN ILLINOIS PROFESSIONAL DESIGN FIRM, NUMBER 184-001157 (EXPIRATION DATE 04/30/2021) DO HEREBY DECLARE THAT WE HAVE PREPARED THE PLAT HEREON DRAWN FOR THE PURPOSE OF VACATING A PUBLIC STREET AS SHOWN, AND THAT THE PLAT IS A TRUE AND CORRECT REPRESENTATION OF SAID VACATION.

ALL DIMENSIONS ARE IN FEET AND DECIMAL PARTS THEREOF. NO DISTANCES OR ANGLES SHOWN HEREON MAY BE ASSUMED BY SCALING.

THIS PROFESSIONAL SERVICE CONFORMS TO THE CURRENT ILLINOIS MINIMUM STANDARDS FOR A BOUNDARY SURVEY.

I HEREBY AUTHORIZE _____ OR THEIR AGENT TO FILE THIS PLAT OF VACATION WITH THE COOK COUNTY RECORDER' OFFCE.

GIVEN UNDER OUR HAND AND SEAL THIS 16th DAY OF JULY, 2019 IN ROSEMONT, ILLINOIS.

Gabriela Ptasinska

GABRIELA PTASINSKA, I.P.L.S. No. 035-3893
LICENSE EXPIRES: 11-30-2020
gptasinska@spacecoinc.com

(VALID ONLY IF EMBOSSED SEAL AFFIXED)

COMPARE ALL DIMENSIONS BEFORE BUILDING AND REPORT ANY DISCREPANCIES AT ONCE. REFER TO DEED OR TITLE POLICY FOR BUILDING LINES AND EASEMENTS.

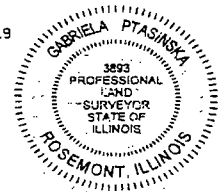

*Ref
July 17, 2019*

CDOT# 03-14-19-3896

SHEET: 2 OF 2

REVISIONS:
07/12/2019
07/16/2019

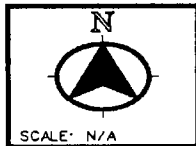

CONSULTING ENGINEERS
SITE DEVELOPMENT ENGINEERS
LAND SURVEYORS

9575 W Higgins Road, Suite 700,
Rosemont, Illinois 60018
Phone: (847) 696-4060 Fax: (847) 696-4065

DATE:	02/22/2019
JOB NO:	10283
FILENAME:	VAC-01



DLA Piper LLP (US)
444 West Lake Street, Suite 900
Chicago, Illinois 60606
www.dlapiper.com

Mariah F. DiGrino
mariah.digrino@us.dlapiper.com
T 312.368.7261

November 6, 2019

The Honorable Tom Tunney, Chairman
City of Chicago Committee on Zoning
Room 304, City Hall
121 North LaSalle Street
Chicago, Illinois 60602

**Re: Application for Industrial-Institutional Planned Development
4100-4230 West Ann Lurie Place / 4044-4210 South Karlov Avenue**

Dear Chairman Tunney:

The undersigned, Mariah F. DiGrino, an attorney with the law firm of DLA Piper LLP (US), which firm represents Greater Chicago Food Depository, the applicant for a proposal to rezone the subject property from the M2-3 Light Industry District to an Industrial-Institutional Planned Development certifies that she has complied with the requirements for Section 17-13-0107 of the Chicago Zoning Ordinance by sending written notice to such property owners who appear to be the owners of the property within the subject area not solely owned by the applicant, and to the owners of all property within 250 feet of each direction of the lot line of the subject property, exclusive of public roads, streets, alleys and other public ways. Said written notice was sent by First Class U.S. Mail, no more than 30 days before filing the application.

The undersigned certifies that the notice contained the address of the property sought to be rezoned; a statement of the intended use of the property; the name and address of the applicant; the name and address of the owner; a statement that the applicant intends to file the application for change in zoning on approximately November 6, 2019, and a source for additional information on the application.

The undersigned certifies that she has made a bona fide effort to determine the addresses of the parties to be notified under Section 17-13-0107 of the Chicago Zoning Ordinance, and that the accompanying list of names and addresses of surrounding property owners within 250 feet of the subject site is a complete list containing the names and addresses of the people required to be served.

Very truly yours,

DLA Piper LLP (US)

Mariah F. DiGrino

Subscribed and sworn to before me
This 12th day of November 2019.

Notary Public

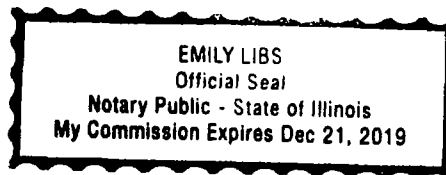



DLA Piper LLP (US)
444 W. Lake Street Suite 900
Chicago, Illinois 60606
www.dlapiper.com

Mariah F. DiGrino
mariah.digrino@us.dlapiper.com
T 312.368.7261

November 6, 2019

FIRST CLASS MAIL

Dear Sir or Madam:

In accordance with the requirements for an Amendment to the Chicago Zoning Ordinance, specifically Section 17-13-0107 of the Municipal Code of the City of Chicago, please be informed that on or about November 6, 2019, the undersigned, on behalf of Greater Chicago Food Depository (the "Applicant"), intends to file an application to rezone the property located at 4100-4230 West Ann Lurie Place / 4044-4210 South Karlov Avenue, Chicago, Illinois (the "Property") from the M2-3 Light Industry District to an Industrial-Institutional Planned Development. A map of the Property is printed on the reverse side of this letter.

A portion of the Property is improved with the Applicant's existing facility. The remainder of the Property is currently vacant, improved with a surface truck parking lot.. The Applicant requests a rezoning of the subject property from the M2-3 Light Industry District to an Industrial-Institutional Planned Development to permit the construction and operation of a meal preparation facility and ancillary improvements housing accessory office, food and beverage service, medical service, educational, community, volunteer and outreach uses, and accessory and incidental uses. The proposed development will contain 0 dwelling units, an existing building containing approximately 275,000 square feet of building area, and a new building containing approximately 60,000 square feet of building area and 306 vehicular parking spaces.

Please note that the Applicant is not seeking to rezone or purchase your property. You are receiving this notice as required by the Chicago Municipal Code because the assessor's tax records indicate that you own property within 250 feet of the Property.

I am an authorized representative of the Applicant and my address is 444 W. Lake Street, Suite 900, Chicago, IL 60606. The Applicant, Greater Chicago Food Depository, is the owner of the property and their address is 4100 W. Ann Lurie Place, Chicago, Illinois 60632.

Please contact me at 312-368-7261 with questions or to obtain additional information.

Very truly yours,

DLA Piper LLP (US)

A handwritten signature in black ink, appearing to read 'Mariah F. DiGrino', with a long horizontal flourish extending to the right.

Mariah F. DiGrino

#20259
INTRO DATE
Nov 13, 2019

CITY OF CHICAGO

APPLICATION FOR AN AMENDMENT TO
THE CHICAGO ZONING ORDINANCE

1. ADDRESS of the property Applicant is seeking to rezone:
4100-4230 West Ann Lurie Place / 4044-4210 South Karlov Avenue, Chicago, IL

2. Ward Number that property is located in: 14th Ward

3. APPLICANT Greater Chicago Food Depository

ADDRESS 4100 W. Ann Lurie Place

CITY Chicago STATE IL ZIP CODE 60632

PHONE 773-648-4948 EMAIL alutsey@gcfd.org

CONTACT PERSON Andrew Lutsey

Is the applicant the owner of the property? YES NO

If the applicant is not the owner of the property, please provide the following information regarding the owner and attach written authorization from the owner allowing the applicant to proceed.

OWNER Same as above.

ADDRESS _____

CITY _____ STATE _____ ZIP CODE _____

PHONE _____ EMAIL _____ CONTACT PERSON _____

4. If the Applicant/Owner of the property has obtained a lawyer as their representative for the rezoning, please provide the following information:

ATTORNEY Mariah DiGrino & Liz Butler - DLA Piper LLP (US)

ADDRESS 444 West Lake Street, Suite 900

CITY Chicago STATE IL ZIP CODE 60606

PHONE (312) 368-7261 / -4092 FAX (312) 236-7516

EMAIL mariah.digrino@dlapiper.com / elizabeth.butler@dlapiper.com

5. If the applicant is a legal entity (Corporation, LLC, Partnership, etc.) please provide the names of all owners as disclosed on the Economic Disclosure Statements:
See attached Economic Disclosure Statements
-
6. On what date did the owner acquire legal title to the subject property? 2001 and 2018
7. Has the present owner previously rezoned this property? If yes, when? No
8. Present Zoning District M2-3 Light Industry District
 Proposed Zoning District Industrial Institutional Planned Development
9. Lot size in square feet (or dimensions) +/- 880,300 square feet
10. Current Use of the Property A portion of the subject property is improved with the Applicant's existing facility. The remainder of the subject property is currently vacant, improved with a surface truck parking lot.
11. Reason for rezoning the property To authorize the construction and operation of a meal preparation facility, with accessory office, food and beverage service, medical service, educational, community, volunteer and outreach uses; Mandatory Planned Development pursuant to Section 17-8-0511 (Large Industrial Developments)
12. Describe the proposed use of the property after the rezoning. Indicate the number of dwelling units; number of parking spaces; approximate square footage of any commercial space; and height of the proposed building. (BE SPECIFIC)
The Applicant requests a rezoning of the subject property to an Industrial-Institutional Planned Development to permit the construction and operation of a meal preparation facility and ancillary improvements housing accessory office, food and beverage service, medical service, educational, community, volunteer and outreach uses, and accessory and incidental uses. The proposed development will contain 0 dwelling units, an existing building containing approximately 275,000 square feet of building area, and a new building containing approximately 60,000 square feet of building area and 306 vehicular parking spaces.
13. The Affordable Requirements Ordinance (ARO) that requires on-site affordable housing units and/or a financial contribution for residential housing projects with ten or more units that receive a zoning change which, among other triggers, increases the allowable floor area, or, for existing Planned Developments, increases the number of units (see attached fact sheet or visit www.cityofchicago.org/ARO for more information). Is this project subject to the ARO?
 YES _____ NO X _____

COUNTY OF COOK
STATE OF ILLINOIS

Dennis R. James, Chief Financial Officer of **GREATER CHICAGO FOOD DEPOSITORY**, being first duly sworn on oath, states that all of the above statements and the statements contained in the documents submitted herewith are true and correct.

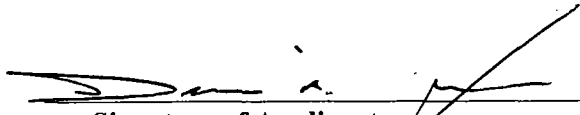

Signature of Applicant

Subscribed and Sworn to before me this
31 day of October, 2019.

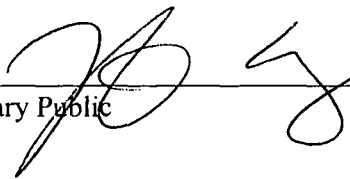

Notary Public

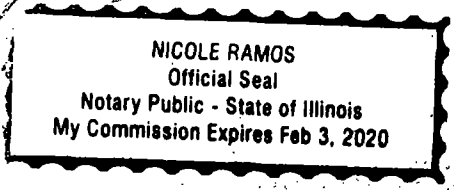

For Office Use Only

Date of Introduction: _____

File Number: _____

Ward: _____

THE UNIVERSITY OF CHICAGO
LIBRARY
540 EAST 57TH STREET
CHICAGO, ILL. 60637

**CITY OF CHICAGO
ECONOMIC DISCLOSURE STATEMENT
AND AFFIDAVIT**

SECTION I -- GENERAL INFORMATION

A. Legal name of the Disclosing Party submitting this EDS. Include d/b/a/ if applicable:

Greater Chicago Food Depository

Check ONE of the following three boxes:

Indicate whether the Disclosing Party submitting this EDS is:

1. the Applicant

OR

2. a legal entity currently holding, or anticipated to hold within six months after City action on the contract, transaction or other undertaking to which this EDS pertains (referred to below as the "Matter"), a direct or indirect interest in excess of 7.5% in the Applicant. State the Applicant's legal name: _____

OR

3. a legal entity with a direct or indirect right of control of the Applicant (see Section II(B)(1))
State the legal name of the entity in which the Disclosing Party holds a right of control:

B. Business address of the Disclosing Party: 4100 W. Ann Lurie Place
Chicago, IL 60632

C. Telephone: 773-843-5427 Fax: 773-843-6492 Email: djames@gcfd.org

D. Name of contact person: Dennis James

E. Federal Employer Identification No. (if you have one): _____

F. Brief description of the Matter to which this EDS pertains. (Include project number and location of property, if applicable):

Zoning Application for property generally located at 4100 West Ann Lurie Place, Chicago, Illinois

G. Which City agency or department is requesting this EDS? Department of Planning and Development

If the Matter is a contract being handled by the City's Department of Procurement Services, please complete the following:

Specification # _____ and Contract # _____

SECTION II -- DISCLOSURE OF OWNERSHIP INTERESTS

A. NATURE OF THE DISCLOSING PARTY

1. Indicate the nature of the Disclosing Party:

- Person
- Publicly registered business corporation
- Privately held business corporation
- Sole proprietorship
- General partnership
- Limited partnership
- Trust
- Limited liability company
- Limited liability partnership
- Joint venture
- Not-for-profit corporation
(Is the not-for-profit corporation also a 501(c)(3))?
 Yes No
- Other (please specify)

2. For legal entities, the state (or foreign country) of incorporation or organization, if applicable:

Illinois

3. For legal entities not organized in the State of Illinois: Has the organization registered to do business in the State of Illinois as a foreign entity?

- Yes
- No
- Organized in Illinois

B. IF THE DISCLOSING PARTY IS A LEGAL ENTITY:

1. List below the full names and titles, if applicable, of: (i) all executive officers and all directors of the entity; (ii) **for not-for-profit corporations**, all members, if any, which are legal entities (if there are no such members, write "no members which are legal entities"); (iii) **for trusts, estates or other similar entities**, the trustee, executor, administrator, or similarly situated party; (iv) **for general or limited partnerships, limited liability companies, limited liability partnerships or joint ventures**, each general partner, managing member, manager or any other person or legal entity that directly or indirectly controls the day-to-day management of the Applicant.

NOTE: Each legal entity listed below must submit an EDS on its own behalf.

Name	Title
------	-------

See attached.

2. Please provide the following information concerning each person or legal entity having a direct or indirect, current or prospective (i.e. within 6 months after City action) beneficial interest (including ownership) in excess of 7.5% of the Applicant. Examples of such an interest include shares in a corporation, partnership interest in a partnership or joint venture, interest of a member or manager in a

2018-2019 Greater Chicago Food Depository Board of Directors

i. Officers

Kate Maehr, Executive Director and CEO

Joan Chow, Chief Marketing Officer

Sheila Creghin, VP of Operations

Andrew Lutsey, VP of Strategic Initiatives

Valerie Parker, Chief People Officer

Nicole Robinson, VP of Community Impact

Dennis James, Chief Financial Officer

Jill Zimmerman, VP of Development

a. Directors

Rhonna Cass, Chair of the Board

Norman M. Leon, Vice Chair
DLA Piper LLP (US)

Monica Brown Moss
Trinity United Church of Christ

Scott Davis
Prophet

Christopher A. Deveny
J.P. Morgan Private Bank

Donald G. Fitzgerald

Clinton H. Hallman, Jr.
LBP Manufacturing LLC

Chris Happ
Goby, Inc.

Grace Hou
Woods Fund Chicago

John H. Idler
ABC 7 Chicago

Peter G. Johnson

Steve Koch

Peter Lantero
Northern Trust

Michael J. Locascio
Reinhart Foodservice, LLC

Jeff Malehorn
World Business Chicago

Patrick M. Mulhern
DMA

Marc Paulhus
Citizens Bank

Monica E. Peek, MD, MPH, MSc
The University of Chicago

Carlos San Jose

Gloria Santona

John Jay Shannon, MD
Cook County Health and Hospitals System

Sylvia Stein
Modine Manufacturing Company

Michael Thompson
Fair Oaks Farms, LLC

Vincent Tomkinson
Grant Thornton LLP

Leon Walker, Esq.
DL3 Realty, LP

limited liability company, or interest of a beneficiary of a trust, estate or other similar entity. If none, state "None."

NOTE: Each legal entity listed below may be required to submit an EDS on its own behalf.

Name	Business Address	Percentage Interest in the Applicant
None		

SECTION III -- INCOME OR COMPENSATION TO, OR OWNERSHIP BY, CITY ELECTED OFFICIALS

Has the Disclosing Party provided any income or compensation to any City elected official during the 12-month period preceding the date of this EDS? Yes No

Does the Disclosing Party reasonably expect to provide any income or compensation to any City elected official during the 12-month period following the date of this EDS? Yes No

If "yes" to either of the above, please identify below the name(s) of such City elected official(s) and describe such income or compensation:

Does any City elected official or, to the best of the Disclosing Party's knowledge after reasonable inquiry, any City elected official's spouse or domestic partner, have a financial interest (as defined in Chapter 2-156 of the Municipal Code of Chicago ("MCC")) in the Disclosing Party? Yes No

If "yes," please identify below the name(s) of such City elected official(s) and/or spouse(s)/domestic partner(s) and describe the financial interest(s).

SECTION IV -- DISCLOSURE OF SUBCONTRACTORS AND OTHER RETAINED PARTIES

The Disclosing Party must disclose the name and business address of each subcontractor, attorney, lobbyist (as defined in MCC Chapter 2-156), accountant, consultant and any other person or entity whom the Disclosing Party has retained or expects to retain in connection with the Matter, as well as the nature of the relationship, and the total amount of the fees paid or estimated to be paid. The Disclosing Party is not required to disclose employees who are paid solely through the Disclosing Party's regular payroll. If the Disclosing Party is uncertain whether a disclosure is required under this Section, the Disclosing Party must either ask the City whether disclosure is required or make the disclosure.

Name (indicate whether retained or anticipated to be retained)	Business Address	Relationship to Disclosing Party (subcontractor, attorney, lobbyist, etc.)	Fees (<u>indicate whether paid or estimated.</u>) NOTE: "hourly rate" or "t.b.d." is not an acceptable response.
--	------------------	--	--

DLA Piper LLP (US) (retained)	444 W. Lake, Ste. 900, Chicago, IL 60606	Attorney	\$0
-------------------------------	--	----------	-----

Space Co, Inc. (retained)	9575 W. Higgins, Ste. 700, Rosemont, IL 60018	Surveyor	\$ (est.)
---------------------------	---	----------	-----------

JLL (retained)	9755 W. Higgins, Ste. 700, Rosemont, IL 60018	Surveyor	\$ (est.)
----------------	---	----------	-----------

Check here if the Disclosing Party has not retained, nor expects to retain, any such persons or entities.

SECTION V -- CERTIFICATIONS

A. COURT-ORDERED CHILD SUPPORT COMPLIANCE

Under MCC Section 2-92-415, substantial owners of business entities that contract with the City must remain in compliance with their child support obligations throughout the contract's term.

Has any person who directly or indirectly owns 10% or more of the Disclosing Party been declared in arrearage on any child support obligations by any Illinois court of competent jurisdiction?

Yes No No person directly or indirectly owns 10% or more of the Disclosing Party.

If "Yes," has the person entered into a court-approved agreement for payment of all support owed and is the person in compliance with that agreement?

Yes No

B. FURTHER CERTIFICATIONS

1. [This paragraph 1 applies only if the Matter is a contract being handled by the City's Department of Procurement Services.] In the 5-year period preceding the date of this EDS, neither the Disclosing Party nor any Affiliated Entity [see definition in (5) below] has engaged, in connection with the performance of any public contract, the services of an integrity monitor, independent private sector inspector general, or integrity compliance consultant (i.e., an individual or entity with legal, auditing, investigative, or other similar skills, designated by a public agency to help the agency monitor the activity of specified agency vendors as well as help the vendors reform their business practices so they can be considered for agency contracts in the future, or continue with a contract in progress).

2. The Disclosing Party and its Affiliated Entities are not delinquent in the payment of any fine, fee, tax or other source of indebtedness owed to the City of Chicago, including, but not limited to, water and sewer charges, license fees, parking tickets, property taxes and sales taxes, nor is the Disclosing Party delinquent in the payment of any tax administered by the Illinois Department of Revenue.

3. The Disclosing Party and, if the Disclosing Party is a legal entity, all of those persons or entities identified in Section II(B)(1) of this EDS:

- a. are not presently debarred, suspended, proposed for debarment, declared ineligible or voluntarily excluded from any transactions by any federal, state or local unit of government;
- b. have not, during the 5 years before the date of this EDS, been convicted of a criminal offense, adjudged guilty, or had a civil judgment rendered against them in connection with: obtaining, attempting to obtain, or performing a public (federal, state or local) transaction or contract under a public transaction; a violation of federal or state antitrust statutes; fraud; embezzlement; theft; forgery; bribery; falsification or destruction of records; making false statements; or receiving stolen property;
- c. are not presently indicted for, or criminally or civilly charged by, a governmental entity (federal, state or local) with committing any of the offenses set forth in subparagraph (b) above;
- d. have not, during the 5 years before the date of this EDS, had one or more public transactions (federal, state or local) terminated for cause or default; and
- e. have not, during the 5 years before the date of this EDS, been convicted, adjudged guilty, or found liable in a civil proceeding, or in any criminal or civil action, including actions concerning environmental violations, instituted by the City or by the federal government, any state, or any other unit of local government.

4. The Disclosing Party understands and shall comply with the applicable requirements of MCC Chapters 2-56 (Inspector General) and 2-156 (Governmental Ethics).

5. Certifications (5), (6) and (7) concern:

- the Disclosing Party;
- any "Contractor" (meaning any contractor or subcontractor used by the Disclosing Party in connection with the Matter, including but not limited to all persons or legal entities disclosed under Section IV, "Disclosure of Subcontractors and Other Retained Parties");
- any "Affiliated Entity" (meaning a person or entity that, directly or indirectly: controls the Disclosing Party, is controlled by the Disclosing Party, or is, with the Disclosing Party, under common control of another person or entity). Indicia of control include, without limitation: interlocking management or ownership; identity of interests among family members, shared facilities and equipment; common use of employees; or organization of a business entity following the ineligibility of a business entity to do business with federal or state or local government, including the City, using substantially the same management, ownership, or principals as the ineligible entity. With respect to Contractors, the term Affiliated Entity means a person or entity that directly or indirectly controls the Contractor, is controlled by it, or, with the Contractor, is under common control of another person or entity;
- any responsible official of the Disclosing Party, any Contractor or any Affiliated Entity or any other official, agent or employee of the Disclosing Party, any Contractor or any Affiliated Entity, acting pursuant to the direction or authorization of a responsible official of the Disclosing Party, any Contractor or any Affiliated Entity (collectively "Agents").

Neither the Disclosing Party, nor any Contractor, nor any Affiliated Entity of either the Disclosing Party or any Contractor, nor any Agents have, during the 5 years before the date of this EDS, or, with respect to a Contractor, an Affiliated Entity, or an Affiliated Entity of a Contractor during the 5 years before the date of such Contractor's or Affiliated Entity's contract or engagement in connection with the Matter:

a. bribed or attempted to bribe, or been convicted or adjudged guilty of bribery or attempting to bribe, a public officer or employee of the City, the State of Illinois, or any agency of the federal government or of any state or local government in the United States of America, in that officer's or employee's official capacity;

b. agreed or colluded with other bidders or prospective bidders, or been a party to any such agreement, or been convicted or adjudged guilty of agreement or collusion among bidders or prospective bidders, in restraint of freedom of competition by agreement to bid a fixed price or otherwise; or

c. made an admission of such conduct described in subparagraph (a) or (b) above that is a matter of record, but have not been prosecuted for such conduct; or

d. violated the provisions referenced in MCC Subsection 2-92-320(a)(4)(Contracts Requiring a Base Wage); (a)(5)(Debarment Regulations); or (a)(6)(Minimum Wage Ordinance).

6. Neither the Disclosing Party, nor any Affiliated Entity or Contractor, or any of their employees, officials, agents or partners, is barred from contracting with any unit of state or local government as a result of engaging in or being convicted of (1) bid-rigging in violation of 720 ILCS 5/33E-3; (2) bid-rotating in violation of 720 ILCS 5/33E-4; or (3) any similar offense of any state or of the United States of America that contains the same elements as the offense of bid-rigging or bid-rotating.

7. Neither the Disclosing Party nor any Affiliated Entity is listed on a Sanctions List maintained by the United States Department of Commerce, State, or Treasury, or any successor federal agency.

8. [FOR APPLICANT ONLY] (i) Neither the Applicant nor any "controlling person" [see MCC Chapter 1-23, Article I for applicability and defined terms] of the Applicant is currently indicted or charged with, or has admitted guilt of, or has ever been convicted of, or placed under supervision for, any criminal offense involving actual, attempted, or conspiracy to commit bribery, theft, fraud, forgery, perjury, dishonesty or deceit against an officer or employee of the City or any "sister agency"; and (ii) the Applicant understands and acknowledges that compliance with Article I is a continuing requirement for doing business with the City. NOTE: If MCC Chapter 1-23, Article I applies to the Applicant, that Article's permanent compliance timeframe supersedes 5-year compliance timeframes in this Section V.

9. [FOR APPLICANT ONLY] The Applicant and its Affiliated Entities will not use, nor permit their subcontractors to use, any facility listed as having an active exclusion by the U.S. EPA on the federal System for Award Management ("SAM").

10. [FOR APPLICANT ONLY] The Applicant will obtain from any contractors/subcontractors hired or to be hired in connection with the Matter certifications equal in form and substance to those in Certifications (2) and (9) above and will not, without the prior written consent of the City, use any such

contractor/subcontractor that does not provide such certifications or that the Applicant has reason to believe has not provided or cannot provide truthful certifications.

11. If the Disclosing Party is unable to certify to any of the above statements in this Part B (Further Certifications), the Disclosing Party must explain below:

None

If the letters "NA," the word "None," or no response appears on the lines above, it will be conclusively presumed that the Disclosing Party certified to the above statements.

12. To the best of the Disclosing Party's knowledge after reasonable inquiry, the following is a complete list of all current employees of the Disclosing Party who were, at any time during the 12-month period preceding the date of this EDS, an employee, or elected or appointed official, of the City of Chicago (if none, indicate with "N/A" or "none").

None

13. To the best of the Disclosing Party's knowledge after reasonable inquiry, the following is a complete list of all gifts that the Disclosing Party has given or caused to be given, at any time during the 12-month period preceding the execution date of this EDS, to an employee, or elected or appointed official, of the City of Chicago. For purposes of this statement, a "gift" does not include: (i) anything made generally available to City employees or to the general public, or (ii) food or drink provided in the course of official City business and having a retail value of less than \$25 per recipient, or (iii) a political contribution otherwise duly reported as required by law (if none, indicate with "N/A" or "none"). As to any gift listed below, please also list the name of the City recipient.

None

C. CERTIFICATION OF STATUS AS FINANCIAL INSTITUTION

1. The Disclosing Party certifies that the Disclosing Party (check one)
 is is not

a "financial institution" as defined in MCC Section 2-32-455(b).

2. If the Disclosing Party IS a financial institution, then the Disclosing Party pledges:

"We are not and will not become a predatory lender as defined in MCC Chapter 2-32. We further pledge that none of our affiliates is, and none of them will become, a predatory lender as defined in MCC Chapter 2-32. We understand that becoming a predatory lender or becoming an affiliate of a predatory lender may result in the loss of the privilege of doing business with the City."

If the Disclosing Party is unable to make this pledge because it or any of its affiliates (as defined in MCC Section 2-32-455(b)) is a predatory lender within the meaning of MCC Chapter 2-32, explain here (attach additional pages if necessary):

If the letters "NA," the word "None," or no response appears on the lines above, it will be conclusively presumed that the Disclosing Party certified to the above statements.

D. CERTIFICATION REGARDING FINANCIAL INTEREST IN CITY BUSINESS

Any words or terms defined in MCC Chapter 2-156 have the same meanings if used in this Part D.

1. In accordance with MCC Section 2-156-110: To the best of the Disclosing Party's knowledge after reasonable inquiry, does any official or employee of the City have a financial interest in his or her own name or in the name of any other person or entity in the Matter?

Yes No

NOTE: If you checked "Yes" to Item D(1), proceed to Items D(2) and D(3). If you checked "No" to Item D(1), skip Items D(2) and D(3) and proceed to Part E.

2. Unless sold pursuant to a process of competitive bidding, or otherwise permitted, no City elected official or employee shall have a financial interest in his or her own name or in the name of any other person or entity in the purchase of any property that (i) belongs to the City, or (ii) is sold for taxes or assessments, or (iii) is sold by virtue of legal process at the suit of the City (collectively, "City Property Sale"). Compensation for property taken pursuant to the City's eminent domain power does not constitute a financial interest within the meaning of this Part D.

Does the Matter involve a City Property Sale?

Yes No

3. If you checked "Yes" to Item D(1), provide the names and business addresses of the City officials or employees having such financial interest and identify the nature of the financial interest:

Name	Business Address	Nature of Financial Interest
------	------------------	------------------------------

4. The Disclosing Party further certifies that no prohibited financial interest in the Matter will be acquired by any City official or employee.

E. CERTIFICATION REGARDING SLAVERY ERA BUSINESS

Please check either (1) or (2) below. If the Disclosing Party checks (2), the Disclosing Party must disclose below or in an attachment to this EDS all information required by (2). Failure to comply with these disclosure requirements may make any contract entered into with the City in connection with the Matter voidable by the City.

 x 1. The Disclosing Party verifies that the Disclosing Party has searched any and all records of the Disclosing Party and any and all predecessor entities regarding records of investments or profits from slavery or slaveholder insurance policies during the slavery era (including insurance policies issued to slaveholders that provided coverage for damage to or injury or death of their slaves), and the Disclosing Party has found no such records.

 2. The Disclosing Party verifies that, as a result of conducting the search in step (1) above, the Disclosing Party has found records of investments or profits from slavery or slaveholder insurance policies. The Disclosing Party verifies that the following constitutes full disclosure of all such records, including the names of any and all slaves or slaveholders described in those records:

SECTION VI -- CERTIFICATIONS FOR FEDERALLY FUNDED MATTERS

NOTE: If the Matter is federally funded, complete this Section VI. If the Matter is not federally funded, proceed to Section VII. For purposes of this Section VI, tax credits allocated by the City and proceeds of debt obligations of the City are not federal funding.

A. CERTIFICATION REGARDING LOBBYING

1. List below the names of all persons or entities registered under the federal Lobbying Disclosure Act of 1995, as amended, who have made lobbying contacts on behalf of the Disclosing Party with respect to the Matter: (Add sheets if necessary):

(If no explanation appears or begins on the lines above, or if the letters "NA" or if the word "None" appear, it will be conclusively presumed that the Disclosing Party means that NO persons or entities registered under the Lobbying Disclosure Act of 1995, as amended, have made lobbying contacts on behalf of the Disclosing Party with respect to the Matter.)

2. The Disclosing Party has not spent and will not expend any federally appropriated funds to pay any person or entity listed in paragraph A(1) above for his or her lobbying activities or to pay any person or entity to influence or attempt to influence an officer or employee of any agency, as defined by applicable federal law, a member of Congress, an officer or employee of Congress, or an employee

of a member of Congress, in connection with the award of any federally funded contract, making any federally funded grant or loan, entering into any cooperative agreement, or to extend, continue, renew, amend, or modify any federally funded contract, grant, loan, or cooperative agreement.

3. The Disclosing Party will submit an updated certification at the end of each calendar quarter in which there occurs any event that materially affects the accuracy of the statements and information set forth in paragraphs A(1) and A(2) above.

4. The Disclosing Party certifies that either: (i) it is not an organization described in section 501(c)(4) of the Internal Revenue Code of 1986; or (ii) it is an organization described in section 501(c)(4) of the Internal Revenue Code of 1986 but has not engaged and will not engage in "Lobbying Activities," as that term is defined in the Lobbying Disclosure Act of 1995, as amended.

5. If the Disclosing Party is the Applicant, the Disclosing Party must obtain certifications equal in form and substance to paragraphs A(1) through A(4) above from all subcontractors before it awards any subcontract and the Disclosing Party must maintain all such subcontractors' certifications for the duration of the Matter and must make such certifications promptly available to the City upon request.

B. CERTIFICATION REGARDING EQUAL EMPLOYMENT OPPORTUNITY

If the Matter is federally funded, federal regulations require the Applicant and all proposed subcontractors to submit the following information with their bids or in writing at the outset of negotiations.

Is the Disclosing Party the Applicant?

Yes No

If "Yes," answer the three questions below:

1. Have you developed and do you have on file affirmative action programs pursuant to applicable federal regulations? (See 41 CFR Part 60-2.)

Yes No

2. Have you filed with the Joint Reporting Committee, the Director of the Office of Federal Contract Compliance Programs, or the Equal Employment Opportunity Commission all reports due under the applicable filing requirements?

Yes No Reports not required

3. Have you participated in any previous contracts or subcontracts subject to the equal opportunity clause?

Yes No

If you checked "No" to question (1) or (2) above, please provide an explanation:

SECTION VII -- FURTHER ACKNOWLEDGMENTS AND CERTIFICATION

The Disclosing Party understands and agrees that:

- A. The certifications, disclosures, and acknowledgments contained in this EDS will become part of any contract or other agreement between the Applicant and the City in connection with the Matter, whether procurement, City assistance, or other City action, and are material inducements to the City's execution of any contract or taking other action with respect to the Matter. The Disclosing Party understands that it must comply with all statutes, ordinances, and regulations on which this EDS is based.
- B. The City's Governmental Ethics Ordinance, MCC Chapter 2-156, imposes certain duties and obligations on persons or entities seeking City contracts, work, business, or transactions. The full text of this ordinance and a training program is available on line at www.cityofchicago.org/Ethics, and may also be obtained from the City's Board of Ethics, 740 N. Sedgwick St., Suite 500, Chicago, IL 60610, (312) 744-9660. The Disclosing Party must comply fully with this ordinance.
- C. If the City determines that any information provided in this EDS is false, incomplete or inaccurate, any contract or other agreement in connection with which it is submitted may be rescinded or be void or voidable, and the City may pursue any remedies under the contract or agreement (if not rescinded or void), at law, or in equity, including terminating the Disclosing Party's participation in the Matter and/or declining to allow the Disclosing Party to participate in other City transactions. Remedies at law for a false statement of material fact may include incarceration and an award to the City of treble damages.
- D. It is the City's policy to make this document available to the public on its Internet site and/or upon request. Some or all of the information provided in, and appended to, this EDS may be made publicly available on the Internet, in response to a Freedom of Information Act request, or otherwise. By completing and signing this EDS, the Disclosing Party waives and releases any possible rights or claims which it may have against the City in connection with the public release of information contained in this EDS and also authorizes the City to verify the accuracy of any information submitted in this EDS.
- E. The information provided in this EDS must be kept current. In the event of changes, the Disclosing Party must supplement this EDS up to the time the City takes action on the Matter. If the Matter is a contract being handled by the City's Department of Procurement Services, the Disclosing Party must update this EDS as the contract requires. **NOTE:** With respect to Matters subject to MCC Chapter 1-23, Article I (imposing **PERMANENT INELIGIBILITY** for certain specified offenses), the information provided herein regarding eligibility must be kept current for a longer period, as required by MCC Chapter 1-23 and Section 2-154-020.

CERTIFICATION

Under penalty of perjury, the person signing below: (1) warrants that he/she is authorized to execute this EDS, and all applicable Appendices, on behalf of the Disclosing Party, and (2) warrants that all certifications and statements contained in this EDS, and all applicable Appendices, are true, accurate and complete as of the date furnished to the City.

Greater Chicago Food Depository
(Print or type exact legal name of Disclosing Party)

By: [Signature]
(Sign here)

DENNIS R. JAMES
(Print or type name of person signing)

CFO
(Print or type title of person signing)

Signed and sworn to before me on (date) 9-4-2019

at COOK County, IL (state).

[Signature]
Notary Public

Commission expires: 2-3-2020



My Commission Expires Feb 3 2020
Notary Public State of Illinois
Official Seal
MICOLE LAMON

**CITY OF CHICAGO
ECONOMIC DISCLOSURE STATEMENT AND AFFIDAVIT
APPENDIX A**

**FAMILIAL RELATIONSHIPS WITH ELECTED CITY OFFICIALS
AND DEPARTMENT HEADS**

This Appendix is to be completed only by (a) the Applicant, and (b) any legal entity which has a direct ownership interest in the Applicant exceeding 7.5%. It is not to be completed by any legal entity which has only an indirect ownership interest in the Applicant.

Under MCC Section 2-154-015, the Disclosing Party must disclose whether such Disclosing Party or any "Applicable Party" or any Spouse or Domestic Partner thereof currently has a "familial relationship" with any elected city official or department head. A "familial relationship" exists if, as of the date this EDS is signed, the Disclosing Party or any "Applicable Party" or any Spouse or Domestic Partner thereof is related to the mayor, any alderman, the city clerk, the city treasurer or any city department head as spouse or domestic partner or as any of the following, whether by blood or adoption: parent, child, brother or sister, aunt or uncle, niece or nephew, grandparent, grandchild, father-in-law, mother-in-law, son-in-law, daughter-in-law, stepfather or stepmother, stepson or stepdaughter, stepbrother or stepsister or half-brother or half-sister.

"Applicable Party" means (1) all executive officers of the Disclosing Party listed in Section II.B.1 a., if the Disclosing Party is a corporation; all partners of the Disclosing Party, if the Disclosing Party is a general partnership; all general partners and limited partners of the Disclosing Party, if the Disclosing Party is a limited partnership; all managers, managing members and members of the Disclosing Party, if the Disclosing Party is a limited liability company; (2) all principal officers of the Disclosing Party; and (3) any person having more than a 7.5% ownership interest in the Disclosing Party. "Principal officers" means the president, chief operating officer, executive director, chief financial officer, treasurer or secretary of a legal entity or any person exercising similar authority.

Does the Disclosing Party or any "Applicable Party" or any Spouse or Domestic Partner thereof currently have a "familial relationship" with an elected city official or department head?

Yes

No

If yes, please identify below (1) the name and title of such person, (2) the name of the legal entity to which such person is connected; (3) the name and title of the elected city official or department head to whom such person has a familial relationship, and (4) the precise nature of such familial relationship.

**CITY OF CHICAGO
ECONOMIC DISCLOSURE STATEMENT AND AFFIDAVIT
APPENDIX B**

BUILDING CODE SCOFFLAW/PROBLEM LANDLORD CERTIFICATION

This Appendix is to be completed only by (a) the Applicant, and (b) any legal entity which has a direct ownership interest in the Applicant exceeding 7.5% (an "Owner"). It is not to be completed by any legal entity which has only an indirect ownership interest in the Applicant.

1. Pursuant to MCC Section 2-154-010, is the Applicant or any Owner identified as a building code scofflaw or problem landlord pursuant to MCC Section 2-92-416?

Yes No

2. If the Applicant is a legal entity publicly traded on any exchange, is any officer or director of the Applicant identified as a building code scofflaw or problem landlord pursuant to MCC Section 2-92-416?

Yes No The Applicant is not publicly traded on any exchange.

3. If yes to (1) or (2) above, please identify below the name of each person or legal entity identified as a building code scofflaw or problem landlord and the address of each building or buildings to which the pertinent code violations apply.

**CITY OF CHICAGO
ECONOMIC DISCLOSURE STATEMENT AND AFFIDAVIT
APPENDIX C**

PROHIBITION ON WAGE & SALARY HISTORY SCREENING - CERTIFICATION

This Appendix is to be completed only by an Applicant that is completing this EDS as a “contractor” as defined in MCC Section 2-92-385. That section, which should be consulted (www.amlegal.com), generally covers a party to any agreement pursuant to which they: (i) receive City of Chicago funds in consideration for services, work or goods provided (including for legal or other professional services), or (ii) pay the City money for a license, grant or concession allowing them to conduct a business on City premises.

On behalf of an Applicant that is a contractor pursuant to MCC Section 2-92-385, I hereby certify that the Applicant is in compliance with MCC Section 2-92-385(b)(1) and (2), which prohibit: (i) screening job applicants based on their wage or salary history, or (ii) seeking job applicants’ wage or salary history from current or former employers. I also certify that the Applicant has adopted a policy that includes those prohibitions.

Yes

No

N/A – I am not an Applicant that is a “contractor” as defined in MCC Section 2-92-385.

This certification shall serve as the affidavit required by MCC Section 2-92-385(c)(1).

If you checked “no” to the above, please explain.
