



# City of Chicago



SO2020-788

Office of the City Clerk

## Document Tracking Sheet

**Meeting Date:** 2/19/2020

**Sponsor(s):** Misc. Transmittal

**Type:** Ordinance

**Title:** Zoning Reclassification Map No. 9-K at 4200 W Belmont Ave, 3202 N Kildare Ave and 4157 W Melrose St - App No. 20350

**Committee(s) Assignment:** Committee on Zoning, Landmarks and Building Standards

FINAL FOR  
PUBLICATION

ORDINANCE

#20350  
INTRO DATE  
FEB 19, 2020

**BE IT ORDAINED BY THE CITY COUNCIL OF THE CITY OF CHICAGO:**

**SECTION 1.** Title 17, of the Municipal Code of Chicago, the Chicago Zoning Ordinance be amended by changing all the Commercial Planned Development No. 409 symbols and indications as shown on Map No. 9-K in the area bounded by

West Melrose Street; a line 84.93 feet east of and parallel to North Keeler Avenue; the alley next south of and parallel to West Melrose Street; North Keeler Avenue; West Belmont Avenue; a line from a point 100.70 feet west of North Kildare Avenue as measured along the north line of West Belmont Avenue to a point 123.5 feet west North Kildare Avenue and 65.90 feet north of West Belmont Avenue; a line 65.90 feet north of West Belmont Avenue; North Kildare Avenue; the alley next north of and parallel to West Belmont Avenue and North Kildare Avenue,

to those of a B2-2 Neighborhood Mixed Use District and a corresponding use district is hereby established in the area above described.

**SECTION 2.** That the Chicago Zoning Ordinance be amended by changing all the B2-2 Neighborhood Mixed-Use District symbols and indications within the area hereinabove described to the designation of Residential Planned Development No. 409 as Amended, which is hereby established in the area above described, subject to such use and bulk regulations as are set forth in the Plan of Development herewith attached and made a part thereof and to no others.

**SECTION 3.** This ordinance shall be in force and effect from and after its passage and due publication.

Applicant: Noah Properties  
Addresses: 4200 West Belmont Avenue, 3202 North Kildare Avenue  
and 4157 West Melrose Street  
Introduction Date: February 11, 2020  
Plan Commission:

# FINAL FOR PUBLICATION

## STANDARD PLANNED DEVELOPMENT STATEMENTS

1. The area delineated herein as Planned Development No. 409, as Amended (Planned Development), consists of approximately 103,679 square feet of gross land area which is depicted on the attached Planned Development Boundary and Property Line Map (Property). Noah Properties, LLC, is the “Applicant” for this Planned Development pursuant to authorization from the property owner.
2. The requirements, obligations and conditions contained within this Planned Development shall be binding upon the Applicant, its successors and assigns and, if different than the Applicant, the legal title holders and any ground lessors. All rights granted hereunder to the Applicant shall inure to the benefit of the Applicant’s successors and assigns and, if different than the Applicant, the legal title holder and any ground lessors. Furthermore, pursuant to the requirements of Section 17-8-0400 of the Chicago Zoning Ordinance, the Property, at the time of application for amendments, modifications or changes (administrative, legislative or otherwise) to this Planned Development are made, shall be under single ownership or designated control. Single designated control is defined in Section 17-8-0400.
3. All applicable official reviews, approvals or permits are required to be obtained by the Applicant or its successors, assignees or grantees. Any dedication or vacation of streets or alleys or grants of easements or any adjustment of the right-of-way shall require a separate submittal to the Department of Transportation on behalf of the Applicant or its successors, assigns or grantees.

Any requests for grants of privilege, or any items encroaching on the public way, shall be in compliance with the Planned Development.

Ingress or egress shall be pursuant to the Planned Development and may be subject to the review and approval of the Departments of Planning and Development and Transportation. Closure of all or any public street or alley during demolition or construction shall be subject to the review and approval of the Department of Transportation.

Pursuant to a negotiated and executed Perimeter Restoration Agreement (“Agreement”) by and between the Department of Transportation’s Division of Infrastructure Management and the Applicant, the Applicant shall provide improvements and restoration of all public way adjacent to the property, which may include, but not be limited to, the following as shall be reviewed and determined by the Department of Transportation’s Division of Infrastructure Management:

- Full width of streets
- Full width of alleys
- Curb and gutter
- Pavement markings
- Sidewalks
- ADA crosswalk ramps

Applicant: Noah Properties, LLC  
Address: 4200 W. Belmont, 3202 N. Kildare, and 4157 W. Melrose  
Introduced: February 19, 2020  
Plan Commission: May 21, 2020

# FINAL FOR PUBLICATION

- Parkway & landscaping

The Perimeter Restoration Agreement must be executed prior to any Department of Transportation and Planned Development Part II review permitting. The Agreement shall reflect that all work must comply with current Rules and Regulations and must be designed and constructed in accordance with the Department of Transportation's Construction Standards for work in the Public Way and in compliance with the Municipal Code of Chicago Chapter 10-20. Design of said improvements should follow the Department of Transportation's Rules and Regulations for Construction in the Public Way as well as The Street and Site Plan Design Guidelines. Any variation in scope or design of public way improvements and restoration must be approved by the Department of Transportation.

Prior to Part II Approval, the Applicant shall submit and the Department of Transportation shall approve a traffic study. If the traffic study identifies infrastructure upgrades or improvements that are warranted by and attributed to the project, the Applicant will be required to fund and install such upgrades and improvements to CDOT standards.

4. This Plan of Development consists of seventeen (17) Statements: a Bulk Regulations Table; an Existing Zoning Map; an Existing Land-Use Map; a Planned Development Boundary and Property Line Map; Site Plan; Site Section & Plan Detail; Roof Plan & Open Space Plan; Enlarged Common Open Space Plan; Landscape Plan (East & West); 3202 Kildare & 4155 Melrose Landscape Plan; Landscape Details; Floor Plans; and, Building Elevations (North, South, East and West) prepared by Jon Splitt Architects and dated May 21, 2020, submitted herein. In any instance where a provision of this Planned Development conflicts with the Chicago Building Code, the Building Code shall control. This Planned Development conforms to the intent and purpose of the Chicago Zoning Ordinance, and all requirements thereto, and satisfies the established criteria for approval as a Planned Development. In case of a conflict between the terms of this Planned Development Ordinance and the Chicago Zoning Ordinance, this Planned Development shall control.
5. The following uses are permitted within the area delineated herein as a Planned Development No. 409, as Amended: Dwelling Units located above the ground floor; Multi-Unit Residential dwelling units; Townhouse; accessory uses; and off-street parking and loading.
6. On-Premise signs and temporary signs, such as construction and marketing signs, shall be permitted within the Planned Development, subject to the review and approval of the Department of Planning and Development. Off-Premise signs are prohibited within the boundary of the Planned Development.
7. For purposes of height measurement, the definitions in the Chicago Zoning Ordinance shall apply. The height of any building shall also be subject to height limitations, if any, established by the Federal Aviation Administration.
8. The maximum permitted floor area ratio (FAR) for the Property shall be in accordance with the attached Bulk Regulations and Data Table. For the purpose of FAR calculations and

Applicant: Noah Properties, LLC

Address: 4200 W. Belmont, 3202 N. Kildare, and 4157 W. Melrose

Introduced: February 19, 2020

Plan Commission. May 21, 2020

## FINAL FOR PUBLICATION

measurements, the definitions in the Zoning Ordinance shall apply. The permitted FAR identified in the Bulk Regulations and Data Table has been determined using a net site area of 95,935 square feet. The resulting maximum FAR shall be 1.51 within the Planned Development.

9. Upon review and determination, Part II Review, pursuant to Section 17-13-0610, a Part II Review Fee shall be assessed by the Department of Planning and Development. The fee, as determined by staff at the time, is final and binding on the Applicant and must be paid to the Department of Revenue prior to the issuance of any Part II approval.
10. The Site and Landscape Plans shall be in substantial conformance with the Landscape Ordinance and any other corresponding regulations and guidelines, including Section 17-13-0800. Final landscape plan review and approval will be by the Department of Planning and Development. Any interim reviews associated with site plan review or Part II reviews, are conditional until final Part II approval.
11. The Applicant shall comply with Rules and Regulations for the Maintenance of Stockpiles promulgated by the Commissioners of the Departments of Streets and Sanitation and Assets, Information, and Services, under Section 13-32-085, or any other provision of the Municipal Code of Chicago.
12. The terms and conditions of development under this Planned Development ordinance may be modified administratively, pursuant to Section 17-13-0611-A, by the Zoning Administrator upon the application for such a modification by the Applicant, its successors and assigns and, if different than the Applicant, the legal title holders and any ground lessors.
13. The Applicant acknowledges that it is in the public interest to design, construct and maintain the project in a manner which promotes, enables and maximizes universal access throughout the Property. Plans for all buildings and improvements on the Property shall be reviewed and approved by the Mayor's Office for People with Disabilities to ensure compliance with all applicable laws and regulations related to access for persons with disabilities and to promote the highest standard of accessibility.
14. The Applicant acknowledges that it is in the public interest to design, construct, renovate and maintain all buildings in a manner that provides healthier indoor environments, reduces operating costs and conserves energy and natural resources. The Applicant shall obtain the number of points necessary to meet the requirements of the Chicago Sustainable Development Policy, in effect at the time the Part II review process is initiated for each improvement that is subject to the aforementioned Policy and must provide documentation verifying compliance.
15. The Applicant acknowledges and agrees that the rezoning of the Property from Planned Development No. 409 to Planned Development No. 409, as Amended, triggers the requirements of Section 2-44-080 of the Municipal Code (the "Affordable Requirements Ordinance" or "ARO"). Any developer of a "residential housing project" within the meaning

Applicant: Noah Properties, LLC

Address: 4200 W. Belmont, 3202 N. Kildare, and 4157 W. Melrose

Introduced: February 19, 2020

Plan Commission: May 21, 2020

## FINAL FOR PUBLICATION

of the ARO must: (i) set aside 10% of the housing units in the residential housing project ("ARO Units") as affordable units, or with the approval of the commissioner of the Department of Housing ("DOH") (subject to the transition provisions of Section 2-44-040(c)), in consultation with the commissioner of the Department of Planning and Development ("DPD") as appropriate; (ii) pay a fee in lieu of the development of the ARO Units (Cash Payment); or (iii) any combination of (i) and (ii); provided, however, that residential housing projects with 20 or more units must provide at least 25% of the ARO Units on-site or off-site (Required Units). If the developer elects to provide ARO Units off-site, the off-site ARO Units must be located within a two-mile radius from the residential housing project and in the same or a different higher income area or downtown district. The Property is located in a higher income area within the meaning of the ARO, and the project has a total of 67 units. As a result, the Applicant's affordable housing obligation is 7 ARO Units (10% of 67 rounded up), 2 of which are Required Units (25% of 67, rounded up). Applicant has agreed to satisfy its affordable housing obligation by providing 7 ARO Units in the for sale buildings to be constructed in the Planned Development, to be approved by the Department of Housing in consultation with DPD as appropriate, as set forth in the Affordable Housing Profile Form attached hereto as an Exhibit. The Applicant agrees that the ARO for sale Units must be affordable to households earning no more than 100% of the Chicago Primary Metropolitan Statistical Area Median Income (AMI), as updated annually by the City of Chicago. If the Applicant subsequently reduces (or increases) the number of ARO Units in the Planned Development, the Applicant shall update and resubmit the Affordable Housing Profile Form to the Department of Housing for review and approval, and DOH may adjust the number of required ARO Units without amending the Planned Development. Prior to the issuance of any building permits for any residential building in the Planned Development, including, without limitation, excavation or foundation permits, the Applicant must execute and record an affordable housing agreement in accordance with Section 2-44-080(L). The terms of the affordable housing agreement and any amendments thereto are incorporated herein by this reference. The Applicant acknowledges and agrees that the affordable housing agreement will be recorded against the Planned Development, or the applicable portion thereof, and will constitute a lien against such property. The Commissioner of DOI may enforce remedies for any breach of this Statement 15, including any breach of any affordable housing agreement, and enter into settlement agreements with respect to any such breach, subject to the approval of the Corporation Counsel, without amending the Planned Development.

16. The Applicant acknowledges that it is the policy of the City to maximize opportunities for Minority and Women-owned Business Enterprises ("M/WBEs") and city residents to compete for contracts and jobs on construction projects approved through the planned development process. To assist the city in promoting and tracking such M/WBE and city resident participation, an applicant for planned development approval shall provide information at three points in the city approval process. First, the applicant must submit to DPD, as part of its application for planned development approval, an M/WBE Participation Proposal. The M/WBE Participation Proposal must identify the applicant's goals for participation of certified M/WBE firms in the design, engineering and construction of the project, and of city residents in the construction work. The city encourages goals of 26%

Applicant: Noah Properties, LLC

Address: 4200 W. Belmont, 3202 N. Kildare, and 4157 W. Melrose

Introduced: February 19, 2020

Plan Commission: May 21, 2020

## FINAL FOR PUBLICATION

MBE and 6% WBE participation (measured against the total construction budget for the project or any phase thereof), and (ii) 50% city resident hiring (measured against the total construction work hours for the project or any phase thereof). The M/WBE Participation Proposal must include a description of the Applicant's proposed outreach plan designed to inform M/WBEs and city residents of job and contracting opportunities. Second, at the time of the Applicant's submission for Part II permit review for the project or any phase thereof, the Applicant must submit to DPD (a) updates (if any) to the Applicant's preliminary outreach plan, (b) a description of the Applicant's outreach efforts and evidence of such outreach, including, without limitation, copies of certified letters to M/WBE contractor associations and the ward office of the alderman in which the project is located and receipts thereof; (c) responses to the Applicant's outreach efforts, and (d) updates (if any) to the applicant's M/WBE and city resident participation goals. Third, prior to issuance of a Certificate of Occupancy for the project or any phase thereof, the Applicant must provide DPD with the actual level of M/WBE and city resident participation in the project or any phase thereof, and evidence of such participation. In addition to the forgoing, DPD may request such additional information as the department determines may be necessary or useful in evaluating the extent to which M/WBEs and city residents are informed of and utilized in planned development projects. All such information will be provided in a form acceptable to the Zoning Administrator. DPD will report the data it collects regarding projected and actual employment of M/WBEs and city residents in planned development projects twice yearly to the Chicago Plan Commission and annually to the Chicago City Council and the Mayor.

17. This Planned Development shall be governed by Section 17-13-0612. Should this Planned Development ordinance lapse, the Zoning Administrator shall initiate a Zoning Map Amendment to rezone the subject property from Planned Development No. 409, as Amended to a B2-2 Neighborhood Mixed-Use Zoning District.

FINAL FOR  
PUBLICATION

PLANNED DEVELOPMENT NO. 409, AS AMENDED

BULK REGULATIONS AND DATA TABLE

Common Address:	4200 W. Belmont Ave; 3202 N. Kildare; 4157 W. Melrose
Gross Site Area:	103,679 square feet
Area in Public ROW:	7,744 square feet
Net Site Area:	95,935 square feet (2.202 acres)
Maximum Floor Area Ratio	1.51 FAR (combined total for all three parcels)
Maximum Number Residential Units for PD:	67 dwelling units
Minimum Number of Off-Street Parking Spaces to be provided within PD:	115 off-street (vehicle) parking spaces
Minimum Number of Bicycle Parking Spaces to be Provided within PD:	20 bicycle parking spaces
Setbacks from Property Line:	Per Site plans
Maximum Building Height allowed within PD:	36 feet

Applicant: Noah Properties, LLC  
Address: 4200 W. Belmont, 3202 N. Kildare, and 4157 W. Melrose  
Introduced: February 19, 2020  
Plan Commission: May 21, 2020



# ARO Affordable Housing Profile Form (AHP)

FINAL FOR PUBLICATION

Submit this form for projects that are subject to the 2015 ARO (all projects submitted to City Council after October 13, 2015). More information is online at [www.cityofchicago.org/ARO](http://www.cityofchicago.org/ARO).

This completed form should be returned to the Department of Housing (DOH), 121 N LaSalle Street, 10th Floor, Chicago, IL 60602. E-mail: [ARO@cityofchicago.org](mailto:ARO@cityofchicago.org)

Date: 04.28.2020

## DEVELOPMENT INFORMATION

Development Name: 4200 Belmont

Development Address: 4200 W. Belmont Ave Chicago IL

Zoning Application Number, if applicable:

Ward:

If you are working with a Planner at the City, what is his/her name?

### Type of City Involvement

check all that apply

City Land

Planned Development (PD)

Financial Assistance

Transit Served Location (TSL) project

Zoning increase

**REQUIRED ATTACHMENTS:** the AHP will not be reviewed until all required docs are received

- ARO Web Form completed and attached - or submitted online on
- ARO "Affordable Unit Details and Square Footage" worksheet completed and attached (*Excel*)
- If ARO units proposed, Dimensioned Floor Plans with affordable units highlighted are attached (*pdf*)
- If ARO units proposed are off-site, required attachments are included (see next page)
- If ARO units are CHA/Authorized Agency units, signed acceptance letter is attached (*pdf*)

## DEVELOPER INFORMATION

Developer Name Bart Przyjemski

Developer Contact 773-202-9819

Developer Address 3901 25th Ave Schiller Park IL 60176

Email [noahproperties2@gmail.com](mailto:noahproperties2@gmail.com)

Developer Phone 773-202-9819

Attorney Name Nick Ftikas

Attorney Phone 312-782-1983

## TIMING

Estimated date marketing will begin December 2020

Estimated date of building permit\* June 2020

Estimated date ARO units will be complete February 2021

\*the in-lieu fee, recorded covenant and \$5,000 per unit administration fee (for off-site units) are required prior to the issuance of any building permits, including the foundation permit.

**PROPOSED UNITS MEET REQUIREMENTS** (to be executed by Developer & ARO Project Manager)

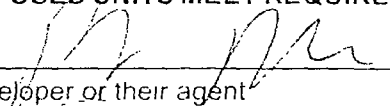
  
Developer or their agent

04.28.2020

Date

Justin Roof or Denise Roman, DOH

4/30/2020

Date





**Applicant Contact Information**

Name: bart przyjemski

Email: noahproperties2@gmail.com

**Development Information**

Are you rezoning to downtown?: No

Is your project subject to the ARO Pilots?: 2015 ARO REQUIREMENTS APPLY

**Address**

**Submitted Date: 04/28/2020**

Number From :4200    Number To: N/A    Direction: W

Street Number:Belmont                      Postal Code: 60641

**Development Name**

4200 Belmont

**Information**

Ward :30

ARO Zone: Higher Income

**Details**

ARO trigger :Zoning change and planned development

Total units: 67

Development type: Sale

TSL Project : TSL-or FAR doesn't exceed 3.5

Submitted date: 04/28/2020

**Requirements**

Affordable units :7    \*On-site aff. Units: 0

How do you intend to meet your required obligation

On-Site: 7    Off-Site: 0

On-Site to CHA or Authorized agency: 0    Off-Site to CHA or Authorized agency: 0

Total Units: 7    In-Lieu Fee Owed: 0

# FINAL FOR PUBLICATION

All projects with proposed ARO units must complete this tab

		Summary				ARO		affordable v. market square footage*	
		market rate	ARO	market rate	ARO	market rate	ARO	market rate	ARO
Market/Rate Units	Affordable Units	unit type	how many?	% of total	avg. square footage	how many?*	% of total	avg. square footage	v. market square footage*
Parking	YES	studio	0	#VALUE!	#DIV/0!	0	#VALUE!	#DIV/0!	#DIV/0!
Laundry	YES	five-bed	4	7%	4,155	0	0%	#DIV/0!	#DIV/0!
Appliances		two-bed	3	5%	1,500	0	0%	#DIV/0!	#DIV/0!
Refrigerator		three-bed	35	58%	1,921	7	100%	1,654	86%
Dishwasher		four-bed	18	30%	2,329	0	0%	#DIV/0!	#DIV/0!
Stove/Oven									
Microwave									
Bathroom(s)									
Half bath? Full bath?									
Kitchen countertops									
Flooring material									
HVAC									
Other									

Project Name: 4200 W. Belmont Ave  
 Zoning Application number, if applicable: \_\_\_\_\_  
 Address: 4200 W. Belmont Ave  
 Is this a For Sale or Rental Project? For Sale  
 Anticipated average psf rent/price?\*

Total Units in Project	67
Total Affordable units	7

FINAL FOR PUBLICATION

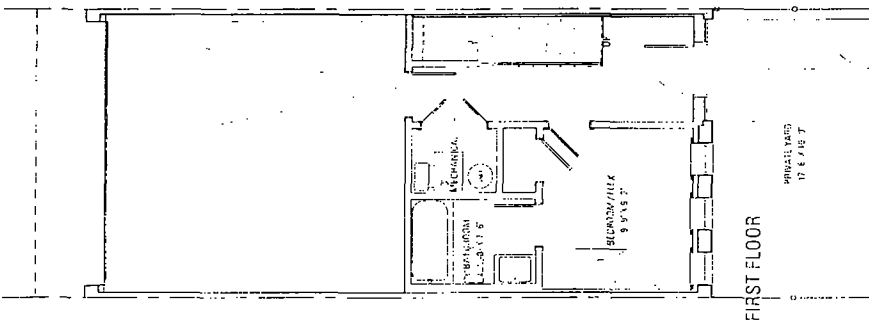
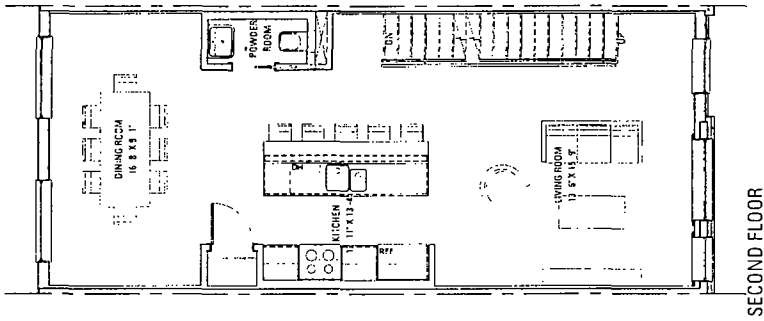
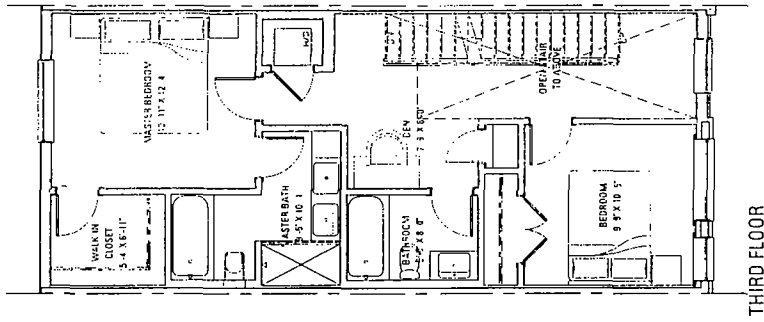
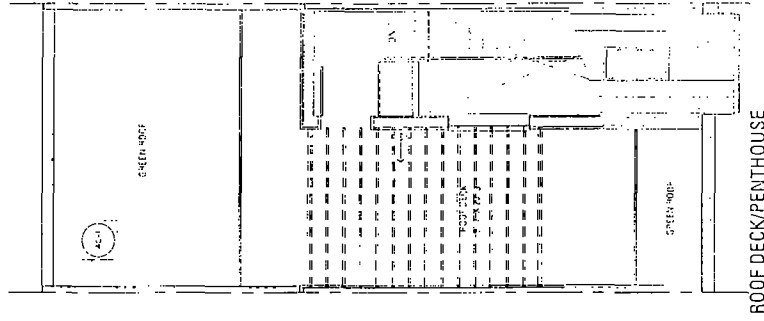

1,950 SQUARE FEET  
3 BEDROOM, 3 BATHROOM  
2 CAR GARAGE

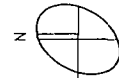

TOWNHOUSE UNIT A PLANS  
5/32" = 1'-0"

**jSa**  
jonathan SPLITT architects ltd  
4001 north ravenwood avenue  
suite 601  
chicago illinois 60613-2576  
773 883 1017 fax 773 883 3081

proj 1931  
RESIDENTIAL PLANNED DEVELOPMENT  
4200 W BELMONT AVE  
CHICAGO IL 60641

description 04 13 20 ISSUED FOR REVIEW

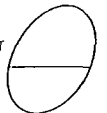

FINAL FOR PUBLICATION

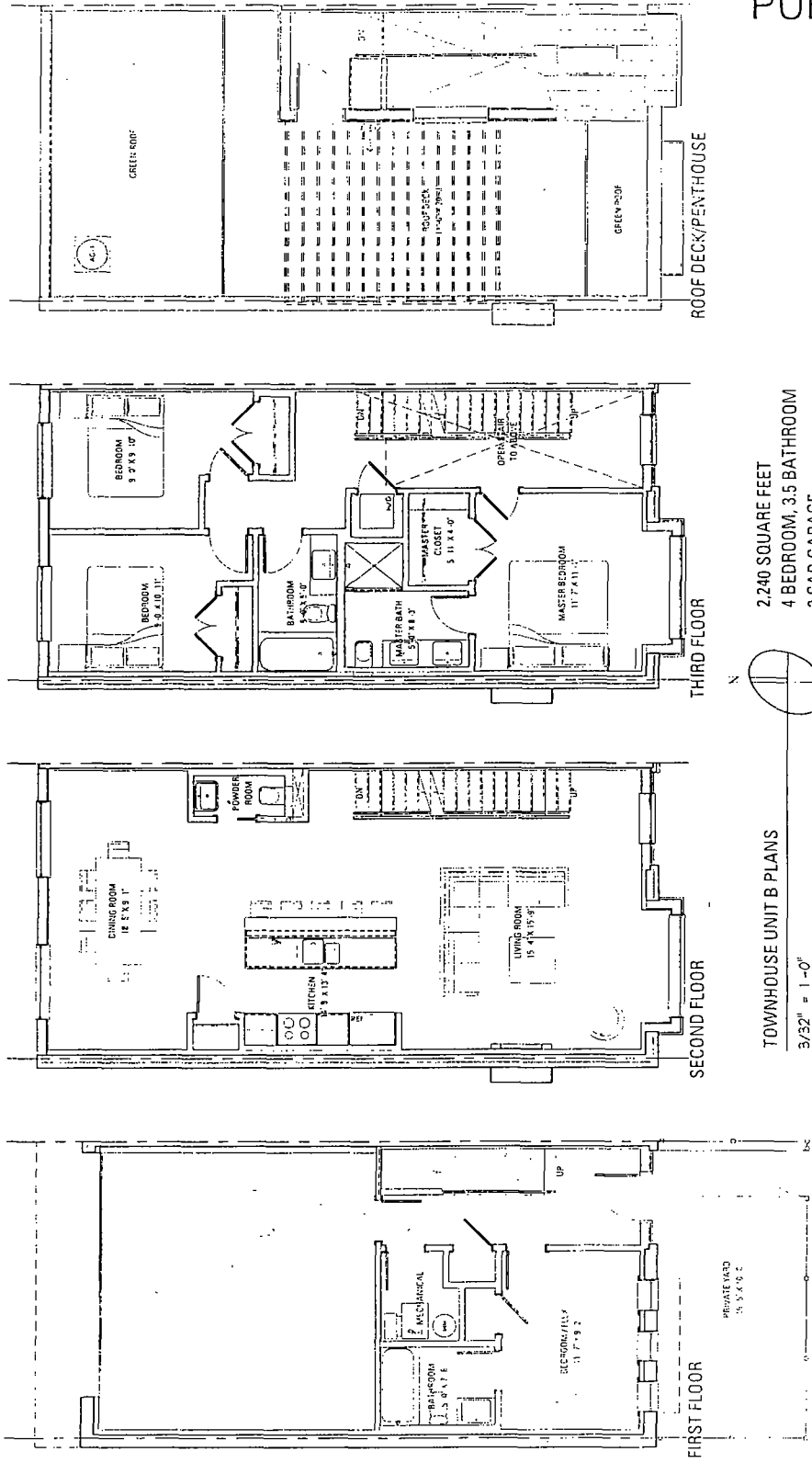

2,240 SQUARE FEET  
4 BEDROOM, 3.5 BATHROOM  
2 CAR GARAGE

TOWNHOUSE UNIT B PLANS  
3/32" = 1'-0"

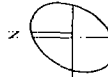

**jsa**  
Jonathan SPLITT architects ltd.  
4001 north ravenwood avenue  
suite 601  
chicago illinois 60613-2576  
773 863 1017 fax 773 863 3081

proj. 1931  
RESIDENTIAL PLANNED DEVELOPMENT  
4200 W BELMONT AVF  
CHICAGO IL 60641

description 04/3/20 ISSUED FOR REVIEW

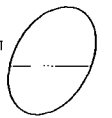

FINAL FOR  
PUBLICATION

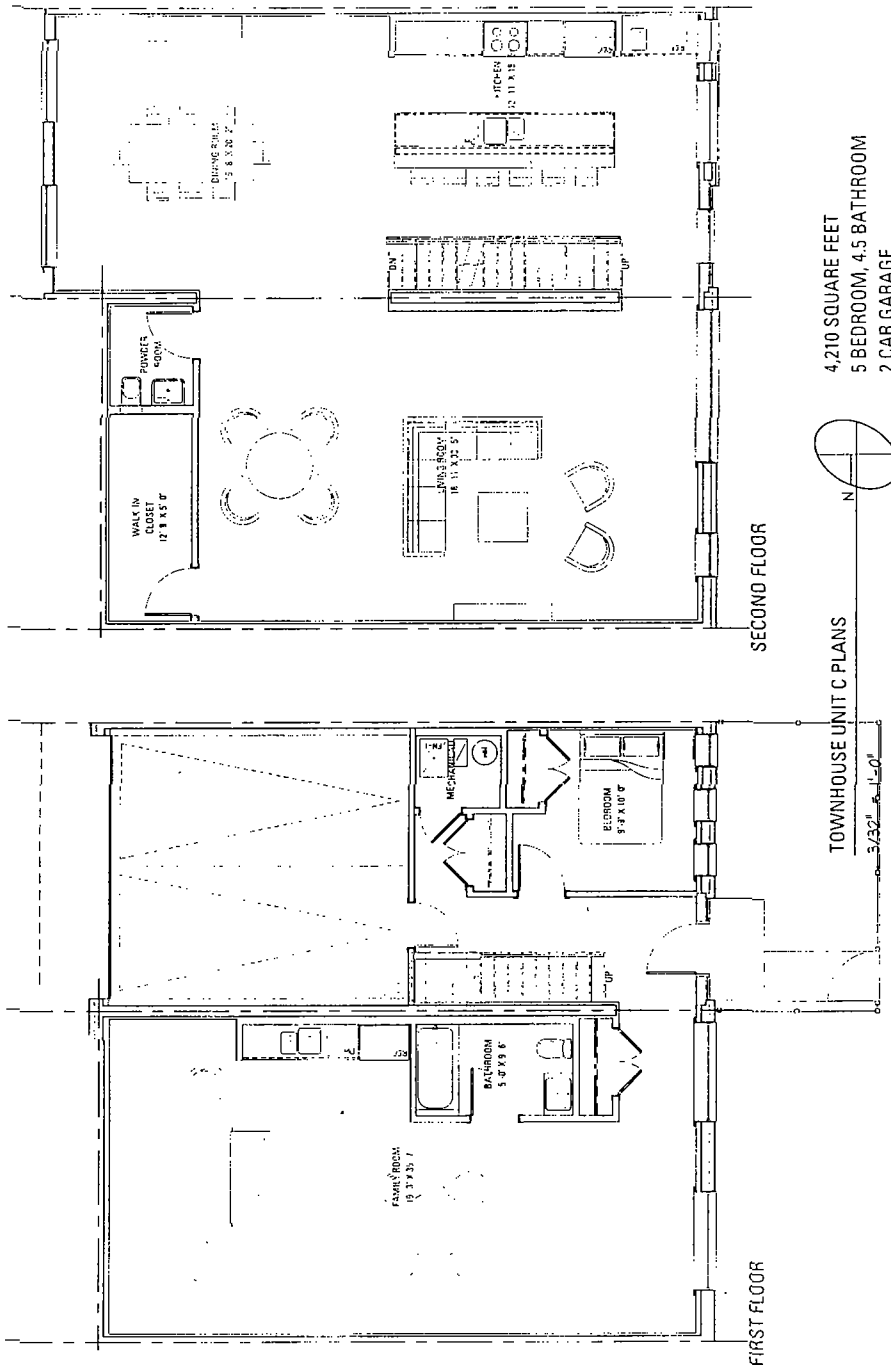

4,210 SQUARE FEET  
5 BEDROOM, 4.5 BATHROOM  
2 CAR GARAGE

TOWNHOUSE UNIT C PLANS  
5/32" = 1'-0"

SECOND FLOOR

FIRST FLOOR

**jsa**  
Jonathan SPLITT architects ltd  
4001 north ravenwood avenue  
suite 501  
chicago illinois 60613-2576  
773 863 1017 fax 773 863 3061

proj. 1931  
RESIDENTIAL PLANNED DEVELOPMENT  
4200 W BELMONT AVE  
CHICAGO IL 60641

description 04-1999, ISSUED FOR REVIEW

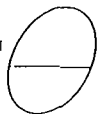

FINAL FOR  
PUBLICATION

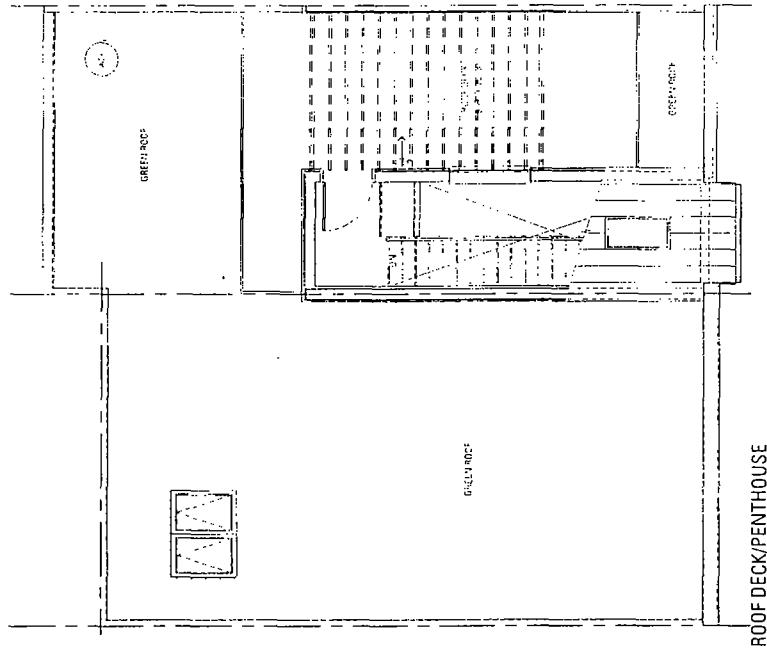

ROOF DECK/PENTHOUSE

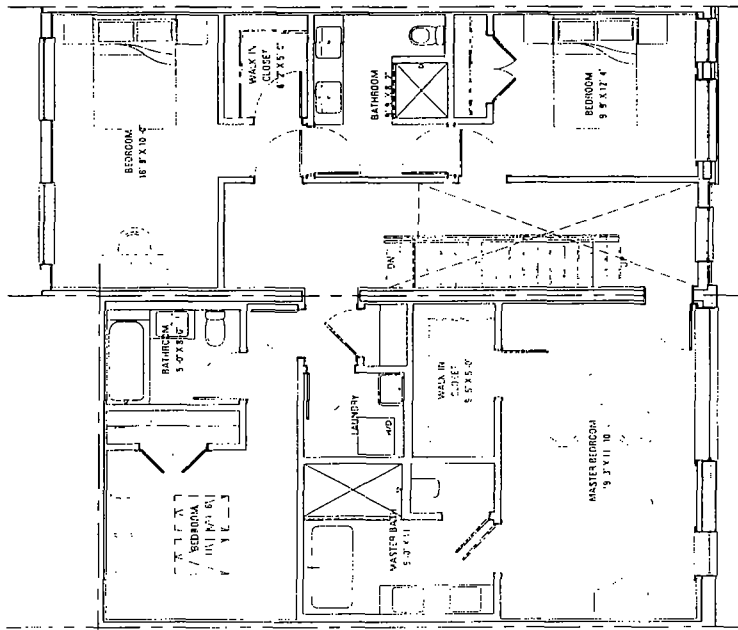

THIRD FLOOR

4,210 SQUARE FEET  
5 BEDROOM, 4.5 BATHROOM  
2 CAR GARAGE



TOWNHOUSE UNIT C PLANS

3/32" = 1'-0"

**jsa**  
Jonathan SPLITT architects ltd  
4001 north ravenwood avenue  
suite 601  
chicago illinois 60613-2576  
773 863 1617 (A) 773 863 3081

proj. 193:  
RESIDENTIAL PLANNED DEVELOPMENT  
4200 W BELLMONT AVE  
CHICAGO IL 60641

description 04/13/00, ISSUED FOR REVIEW

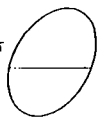



FINAL FOR  
PUBLICATION

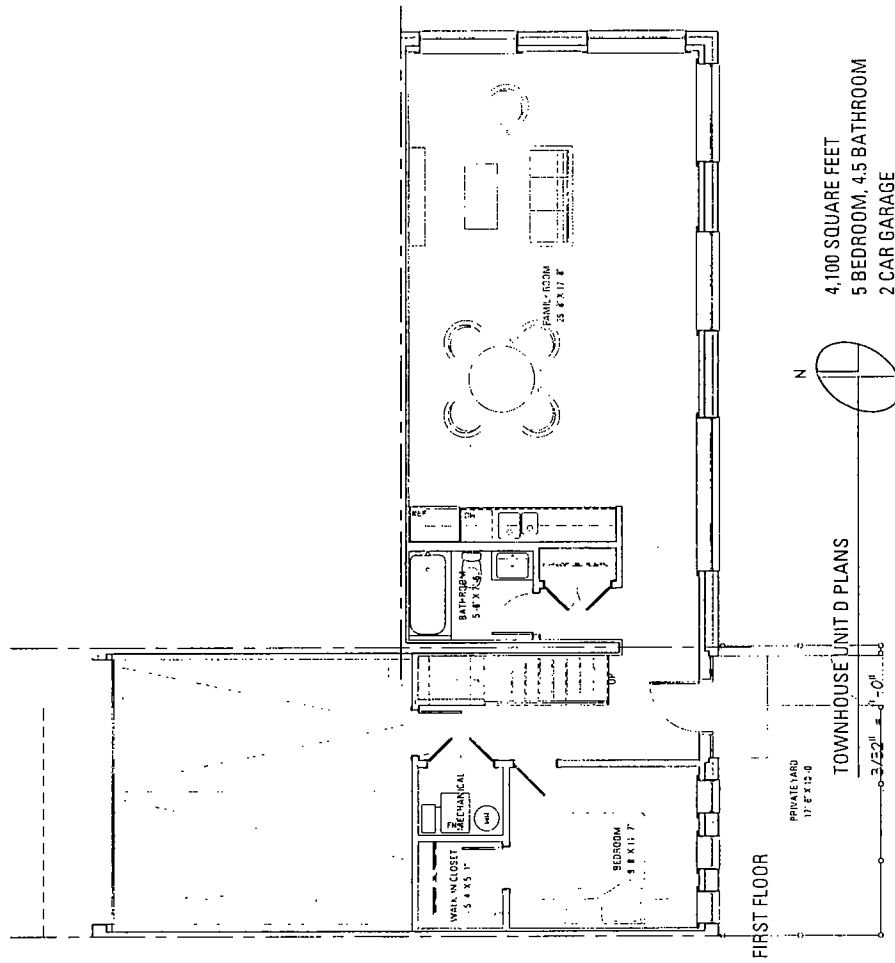

4,100 SQUARE FEET  
5 BEDROOM, 4.5 BATHROOM  
2 CAR GARAGE

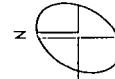

TOWNHOUSE UNIT D PLANS

FIRST FLOOR

**jSa**

Jonathan SPLITT architects Ltd

4001 north ravenwood avenue  
suite 601  
chicago illinois 60613-2576  
773 863 1017 fax 773 863 3001

proj. 1931  
RESIDENTIAL PLANNED DEVELOPMENT  
4200 W BELMONT AVE  
CHICAGO IL 60641

description 02-11-20 ISSUED FOR REVIEW

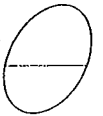

FINAL FOR  
PUBLICATION

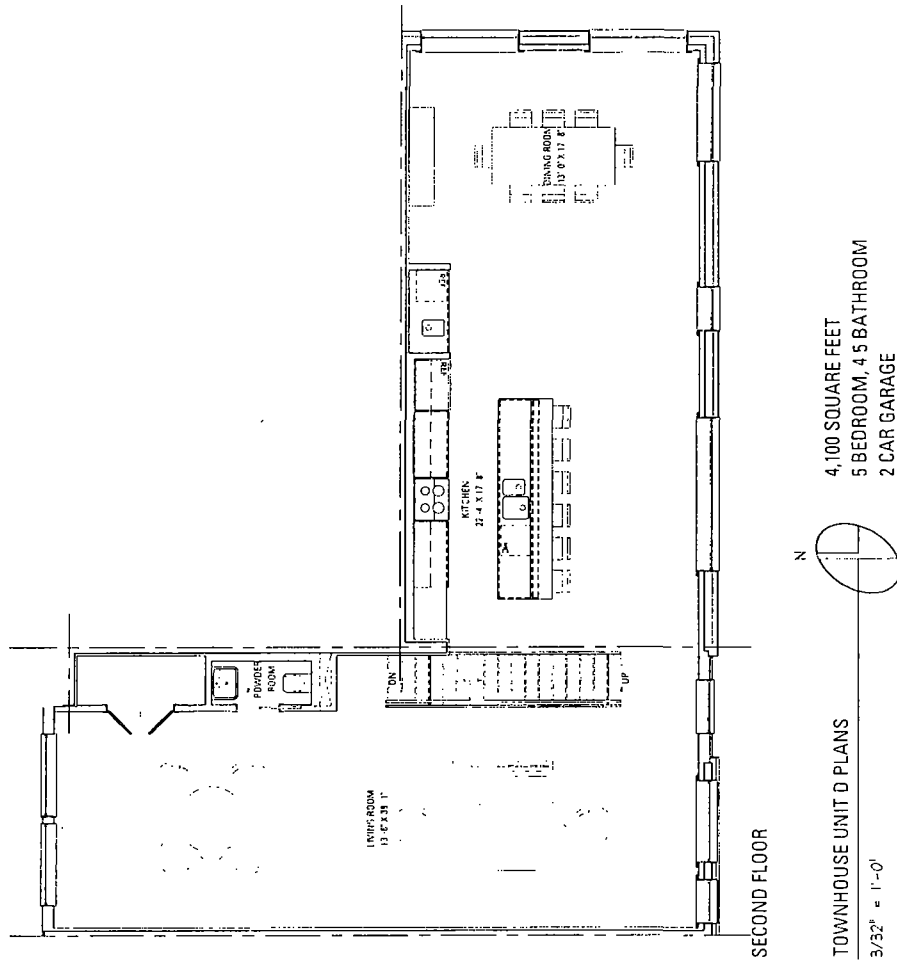

SECOND FLOOR

4,100 SQUARE FEET  
5 BEDROOM, 4.5 BATHROOM  
2 CAR GARAGE

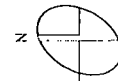

TOWNHOUSE UNIT D PLANS

3/52" = 1'-0"

**jSa**

Jonathan SPLITT architects Ltd.  
4001 North Ravenswood Avenue  
Suite 601  
Chicago Illinois 60613-2576  
773 883 1017 fax 773 883 3081

proj. 1931  
RESIDENTIAL PLANNED DEVELOPMENT  
4200 W. BE. MONT AVE  
CHICAGO IL 60641

description 04/13/20 ISSUED FOR REVIEW

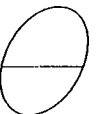

FINAL FOR  
PUBLICATION

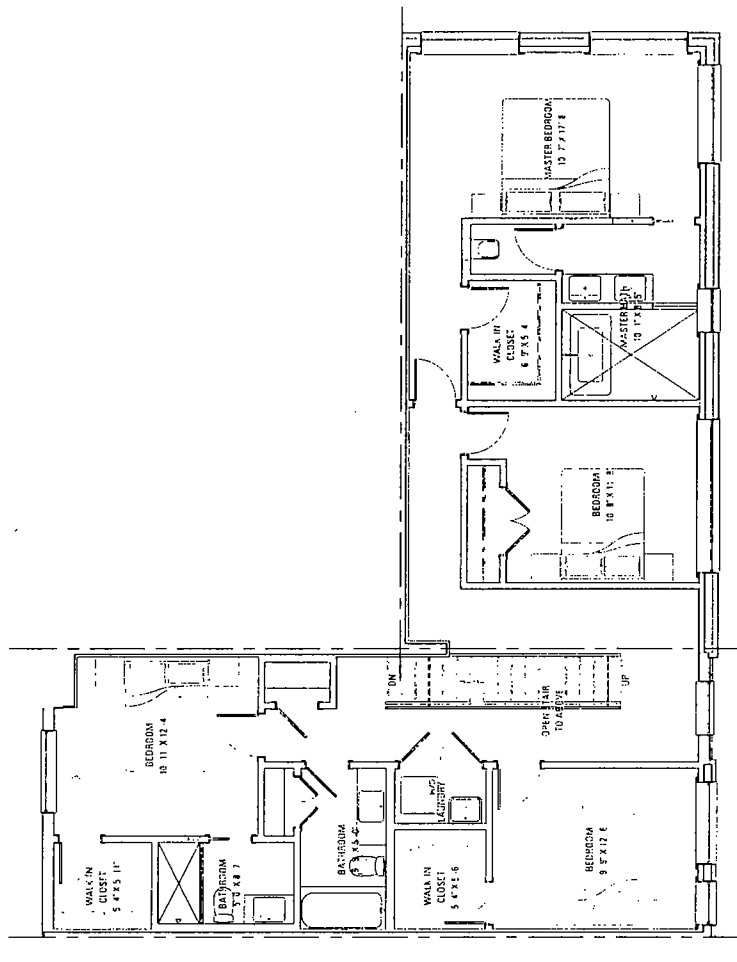

THIRD FLOOR

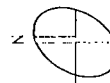

4,100 SQUARE FEET  
5 BEDROOM, 4.5 BATHROOM  
2 CAR GARAGE

TOWNHOUSE UNIT D PLANS

3/32" = 1'-0"

**jsa**  
Jonathan SPLITT architects Ltd.  
4001 north ravenwood avenue  
suite 601  
chicago illinois 60613-2576  
773 883 1017 fax 773 883 3081

proj. 1931  
RESIDENTIAL PLANNED DEVELOPMENT  
4200 W BELMONT AVE  
CHICAGO IL 60641

description 04/13/00, ISSUED FOR REVIEW

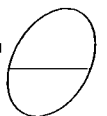

FINAL FOR  
PUBLICATION

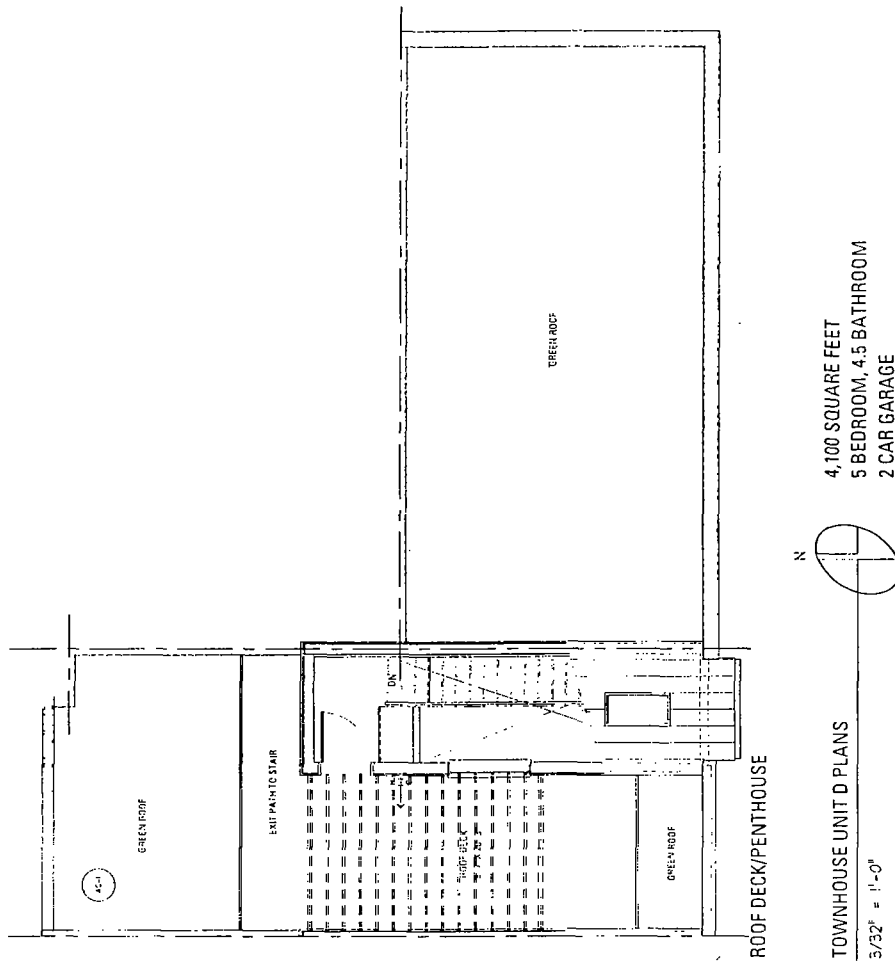

**jSa**

Jonathan SPLITT architects ltd  
4001 north ravenwood avenue  
suite 601  
chicago illinois 60613-2576  
773 883 1017 fax 773 883 3081

proj. 1931  
RESIDENTIAL PLANNED DEVELOPMENT  
4200 W BELMONT AVE  
CHICAGO IL 60641

description 04 13/20. ISSUED FOR REVIEW

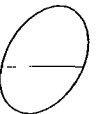

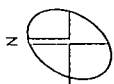
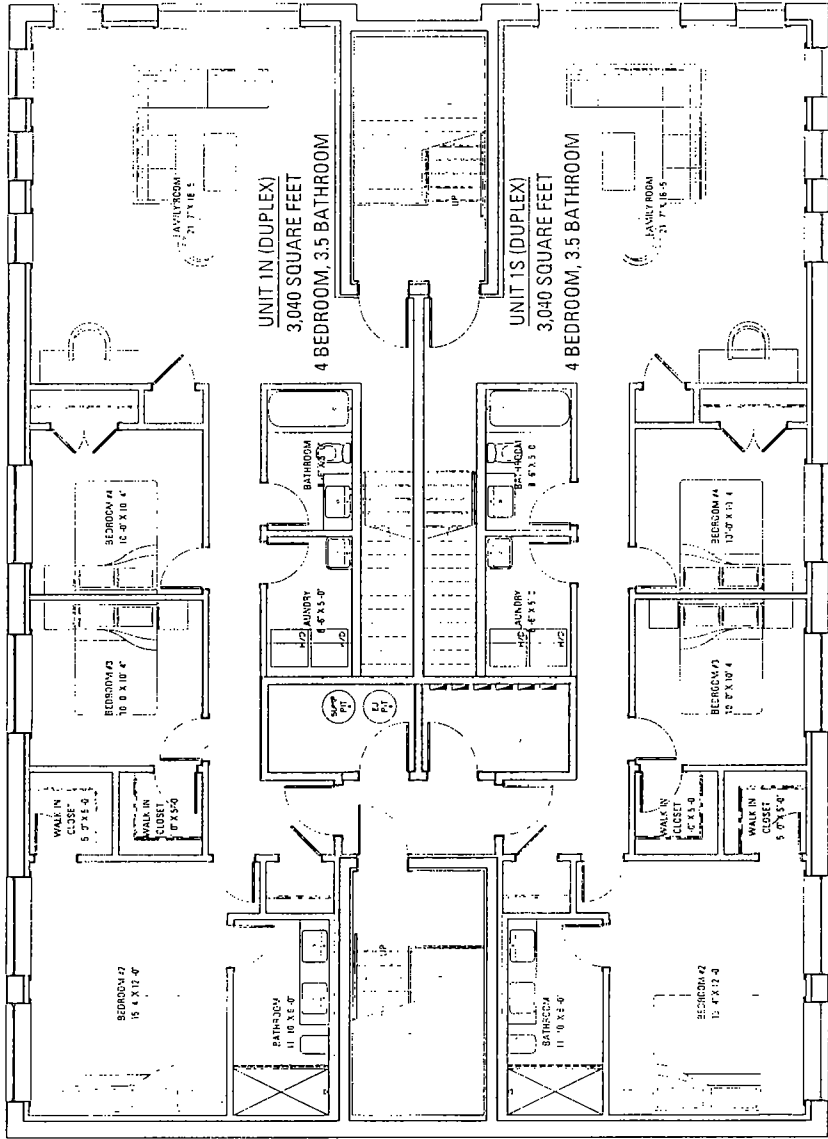

BASEMENT  
3202 N KILDARE PLANS  
3/22" = 1'-0"

**jSa**  
Jonathan SPLITT architects ltd  
4001 north ravenwood avenue  
suite 601  
chicago illinois 60613-2576  
773 683 1017 fax 773 683 0087

proj. 1931  
RESIDENTIAL PLANNED DEVELOPMENT  
4200 W BELMONT AVE  
CHICAGO IL 60641  
description 04/13/20 ISSUED FOR REVIEW

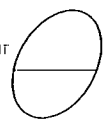

FINAL FOR  
PUBLICATION

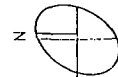
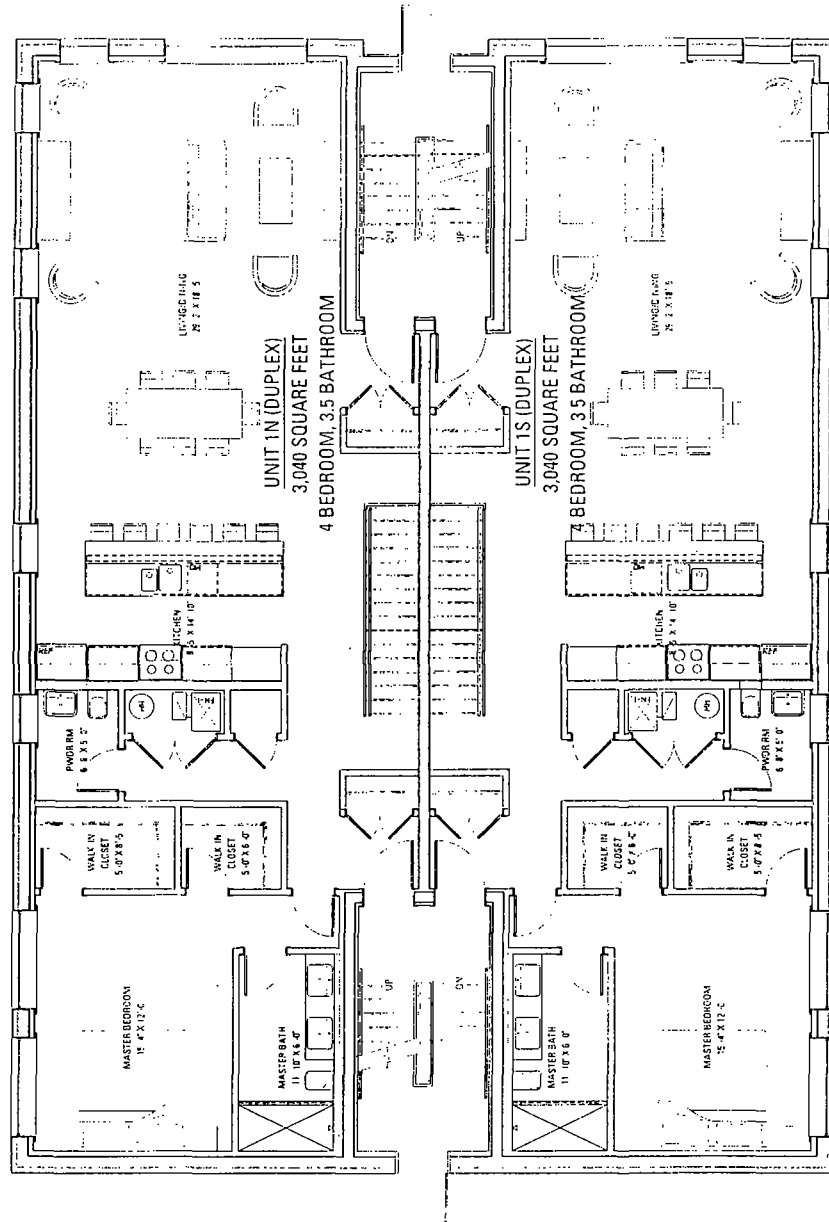

FIRST FLOOR  
3202 N KILDARE PLANS  
3/32' = 1'-0"

**jSa**  
Jonathan SPLITT architects ltd  
4001 north ravenwood avenue  
suite 601  
chicago illinois 60613-2575  
773 983 1017 fax 773 993 3087

proj. 1931  
RESIDENTIAL PLANNED DEVELOPMENT  
4200 W BELMONT AVE  
CHICAGO IL 60641  
description 04/13/20 ISSUED FOR REVIEW

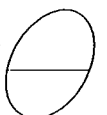

Units 2N, 2S and 3N only

FINAL FOR PUBLICATION

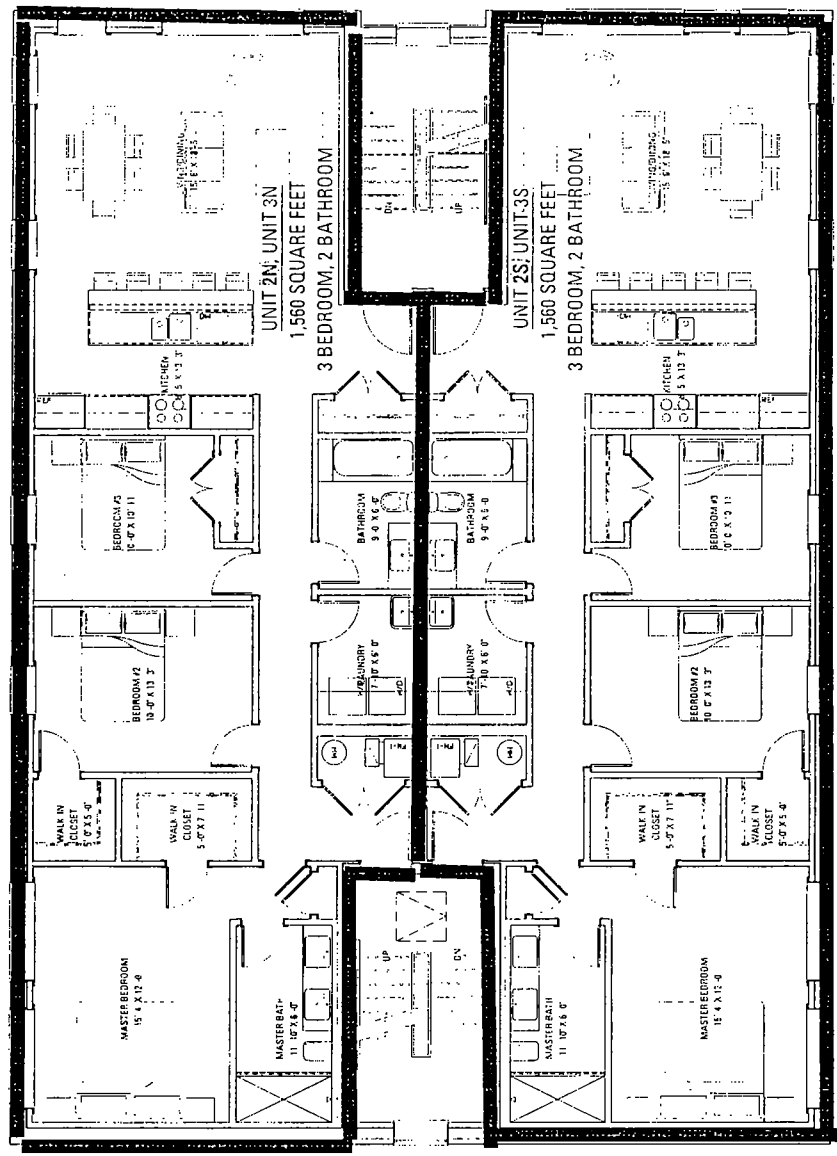

SECOND/THIRD FLOOR  
 3202 N KILDARE PLANS  
 3/32" = 1'-0"

**jSa**  
 Jonathan SPLITT architects ltd  
 4001 north ravenwood avenue  
 suite 601  
 chicago illinois 60613-2576  
 773 883 1017 fax 773 883 3081

proj. 1931  
 RESIDENTIAL PLANNED DEVELOPMENT  
 4200 W BELMONT AVE  
 CHICAGO, IL 60641  
 description 04 1320 ISSUED FOR REVIEW

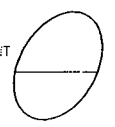

Units 1W, 1S ONLY

FINAL FOR PUBLICATION

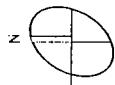
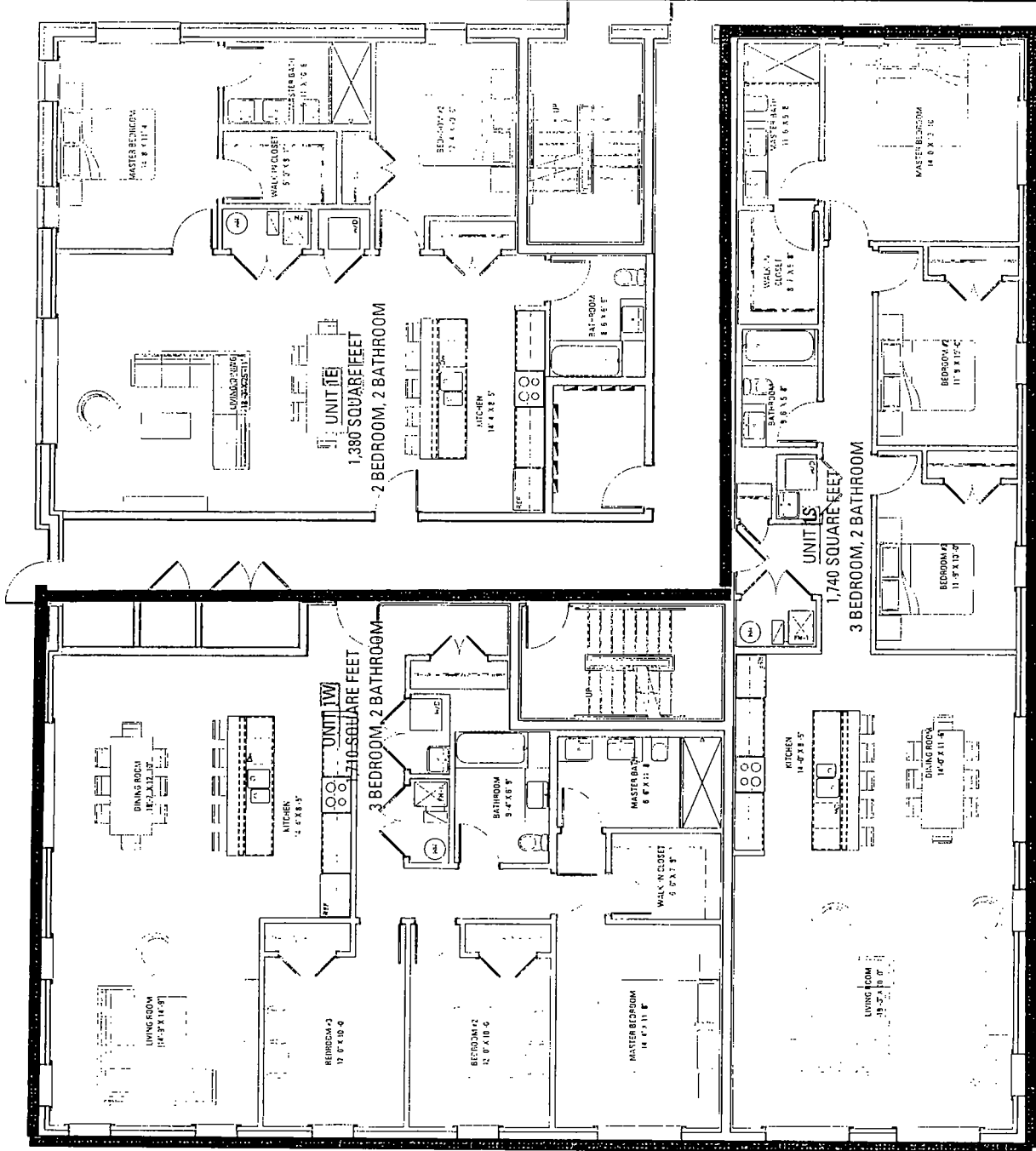

FIRST FLOOR  
4155 W MELROSE PLANS  
3/22" = 1'-0"

jSa

Jonathan SPLITT architects ltd  
4001 north ravenwood avenue  
suite 601  
chicago illinois 60613-2576  
773 883 1017 fax 773 883 3081

proj. \*931  
RESIDENTIAL PLANNED DEVELOPMENT  
4200 W BELMONT AVE  
CHICAGO IL 60641

description 041120 ISSUED FOR REVIEW

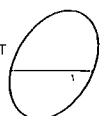



Units 2W and 2S only

FINAL FOR PUBLICATION

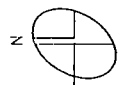
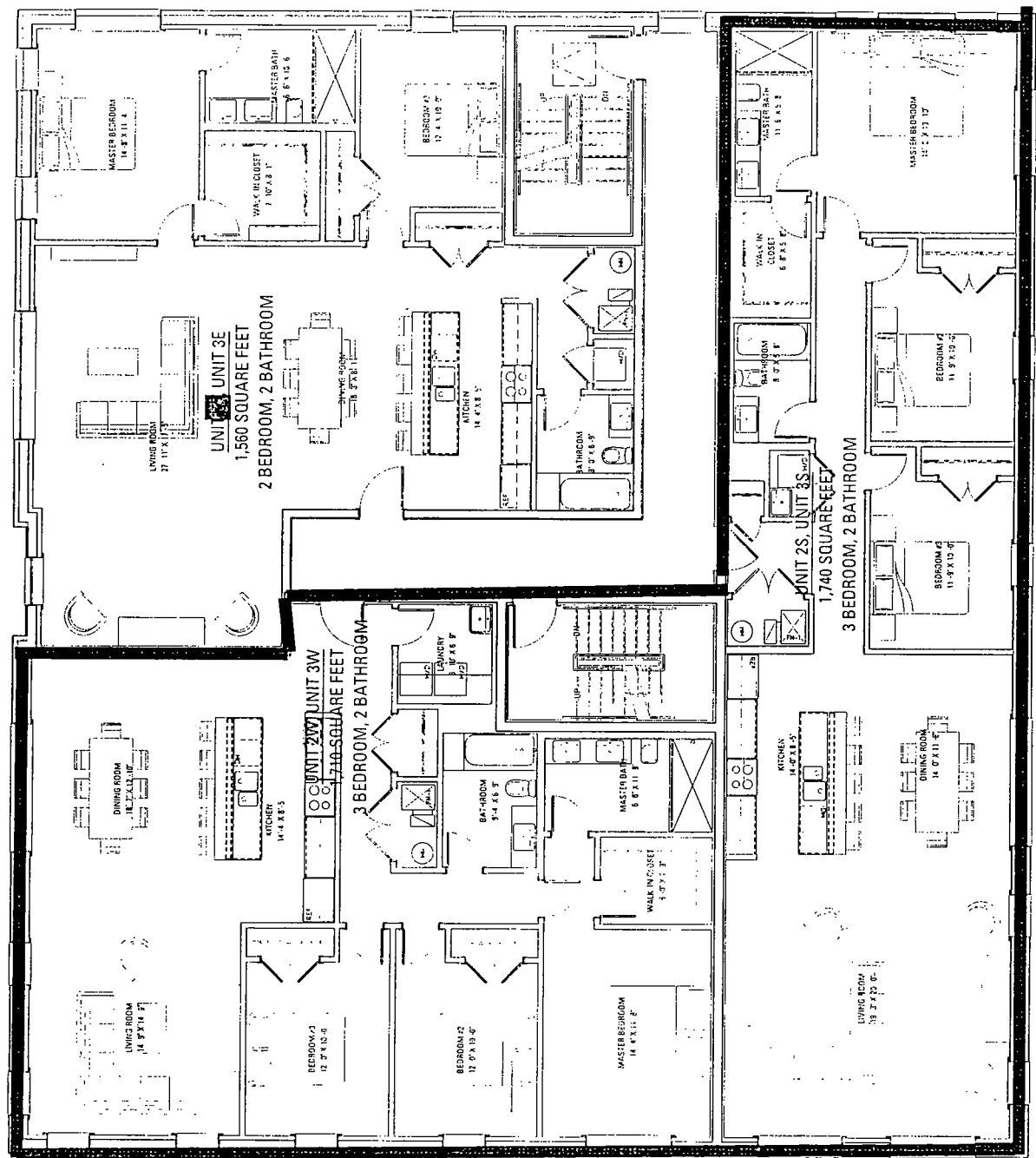

SECOND/THIRD FLOOR  
4155 W MELROSE PLANS  
3/32" = 1'-0"

jSa  
Jonathan SPLITT Architects Ltd  
4001 north ravenwood avenue  
suite 601  
chicago illinois 60613-2576  
773 883 1017 fax 773 883 3081

proj. 1931  
RESIDENTIAL PLANNED DEVELOPMENT  
4200 W BELMONT AVE  
CHICAGO IL 60641  
description 04/13/20 ISSUED FOR REVIEW

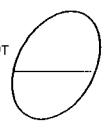

FINAL FOR PUBLICATION

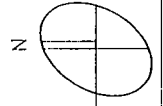
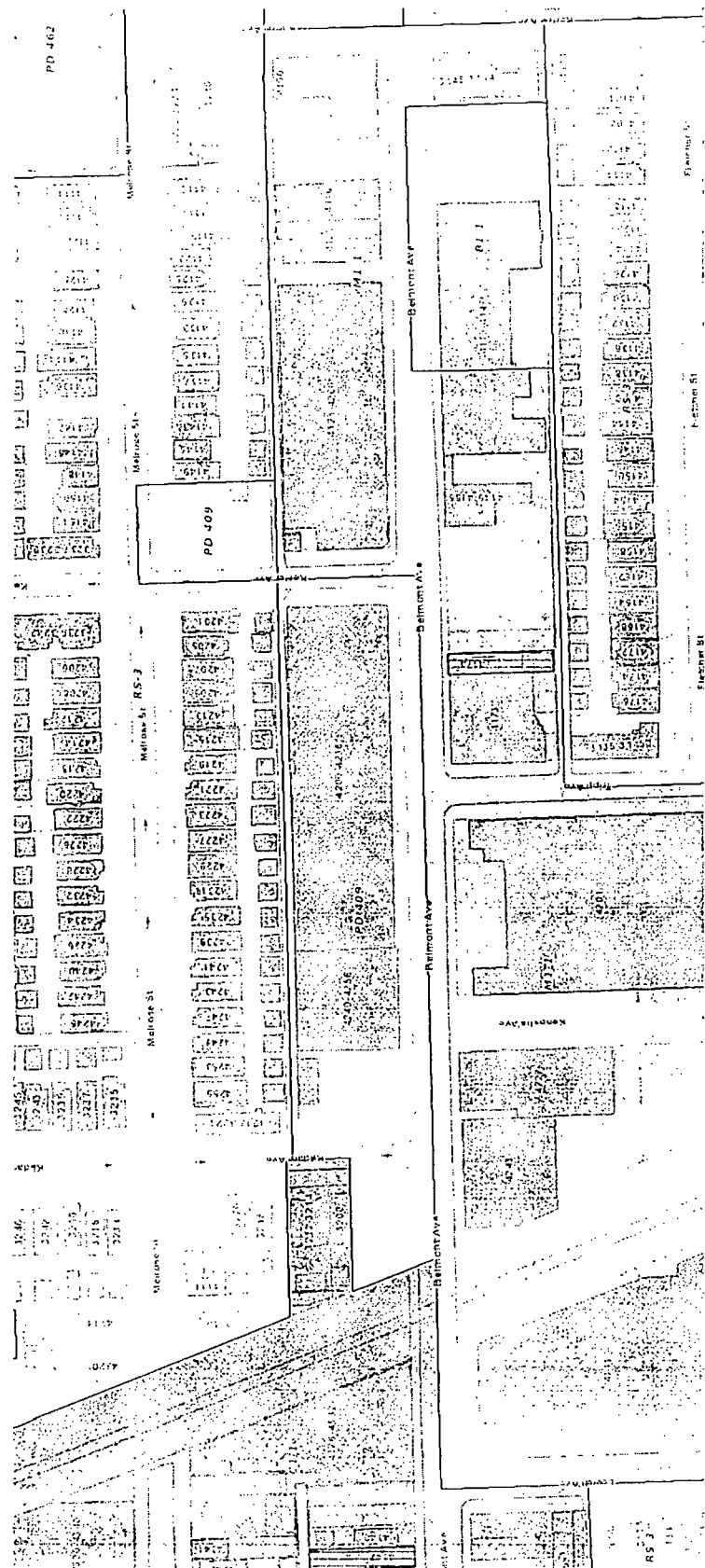

ZONING MAP

N.T.S.

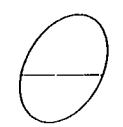

**jsa**  
 jonathan SPLITT architects ltd.  
 4001 north ravenwood avenue  
 suite 601  
 chicago illinois 60613-2576  
 773 893 1017 fax 773 893 3081

applicant  
 address

NOAH PROPERTIES, LLC  
 4200 W BELMONT AVE  
 3202 N KILDARE AVE  
 4157 W MELROSE ST  
 CHICAGO IL 60641

intro date  
 plan commission date

02/19/2020  
 05/21/2020

FINAL FOR PUBLICATION

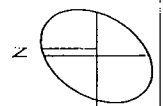
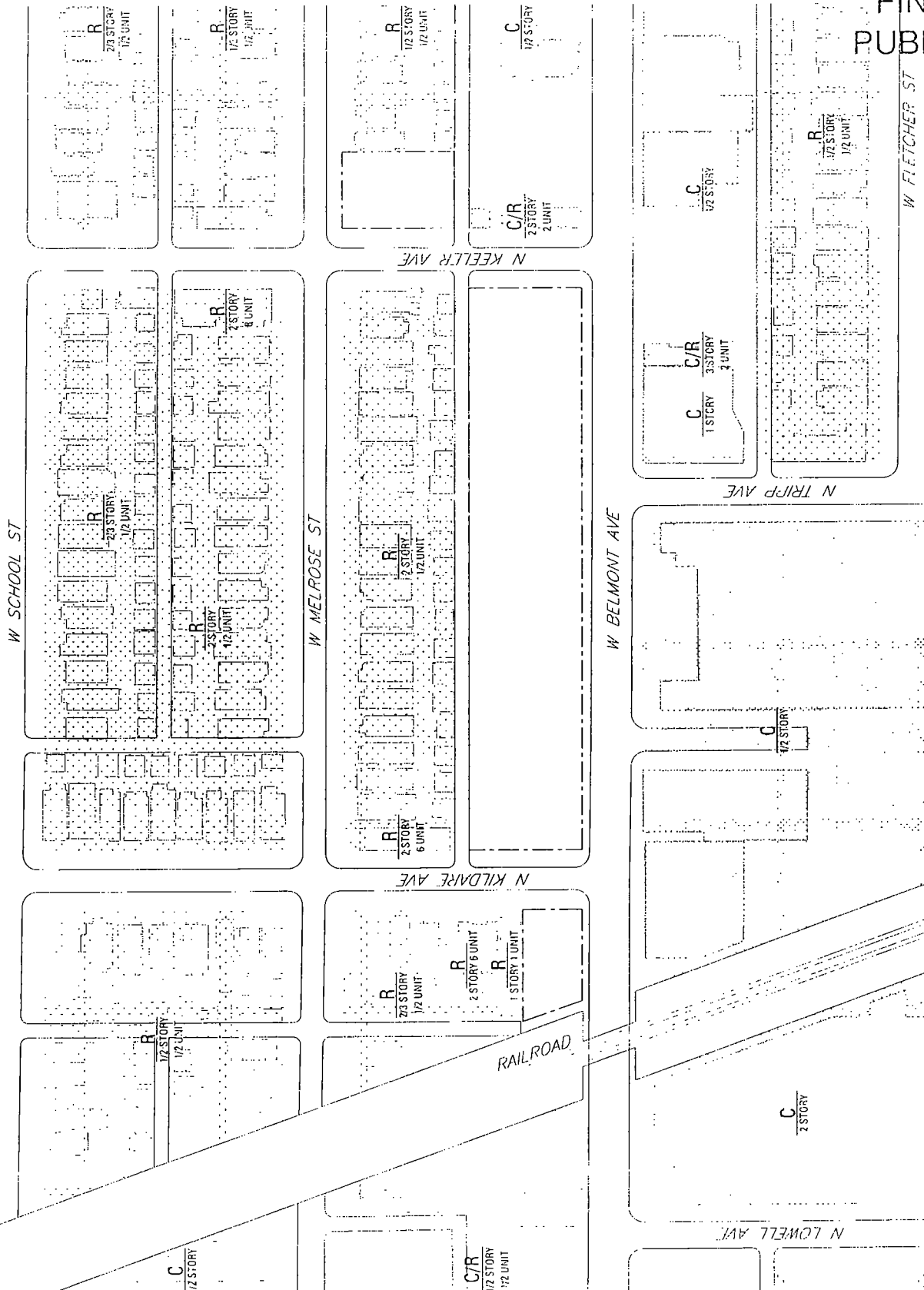

SURROUNDING LAND USE MAP

1" = 150'-0"

**jSa**  
 jonathan SPLITT architects ltd  
 4001 north ravenswood avenue  
 suite 601  
 chicago illinois 60613-2576  
 773 883 1017 fax 773 883 3081

applicant	NOAH PROPERTIES, LLC
address	4200 W BELMONT AVE 3202 N KILDARE AVE 4157 W MELROSE ST CHICAGO IL 60641
intro date	02/19/2020
plan commission date	05/21/2020

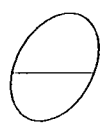

FINAL FOR PUBLICATION

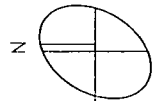
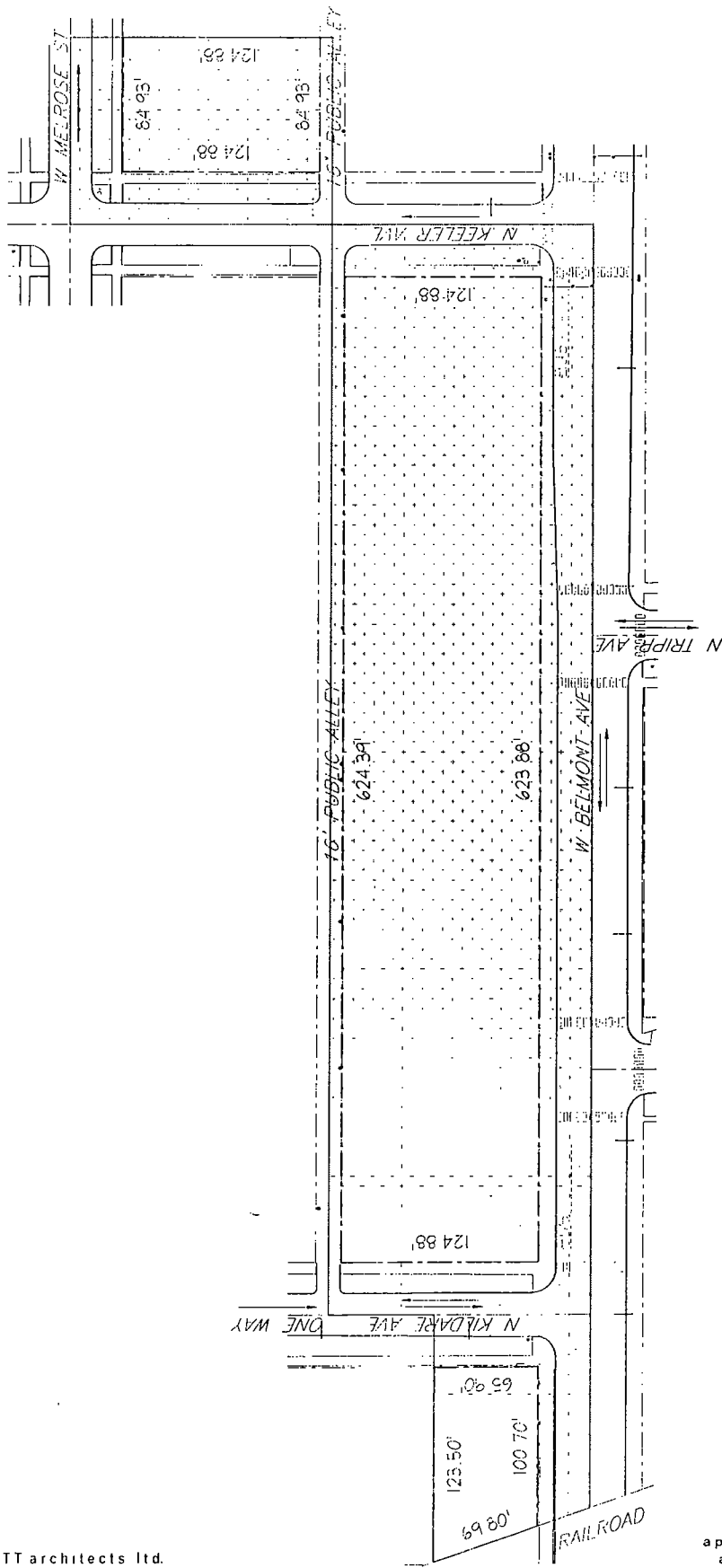

PROPERTY LINES & PD BOUNDARY MAP

1" = 100'-0"

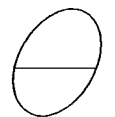

**jsa**

Jonathan SPLITT architects Ltd.  
 4001 north ravenwood avenue  
 suite 801  
 chic ago illinois 60613-2576  
 773 883 1017 fax 773 883 3081

applicant  
 address

NOAH PROPERTIES, LLC  
 4200 W BELMONT AVE  
 3202 N KILDARE AVE  
 4157 W MELROSE ST  
 CHICAGO IL 60641

intro date  
 plan commission date

02/19/2020  
 05/21/2020

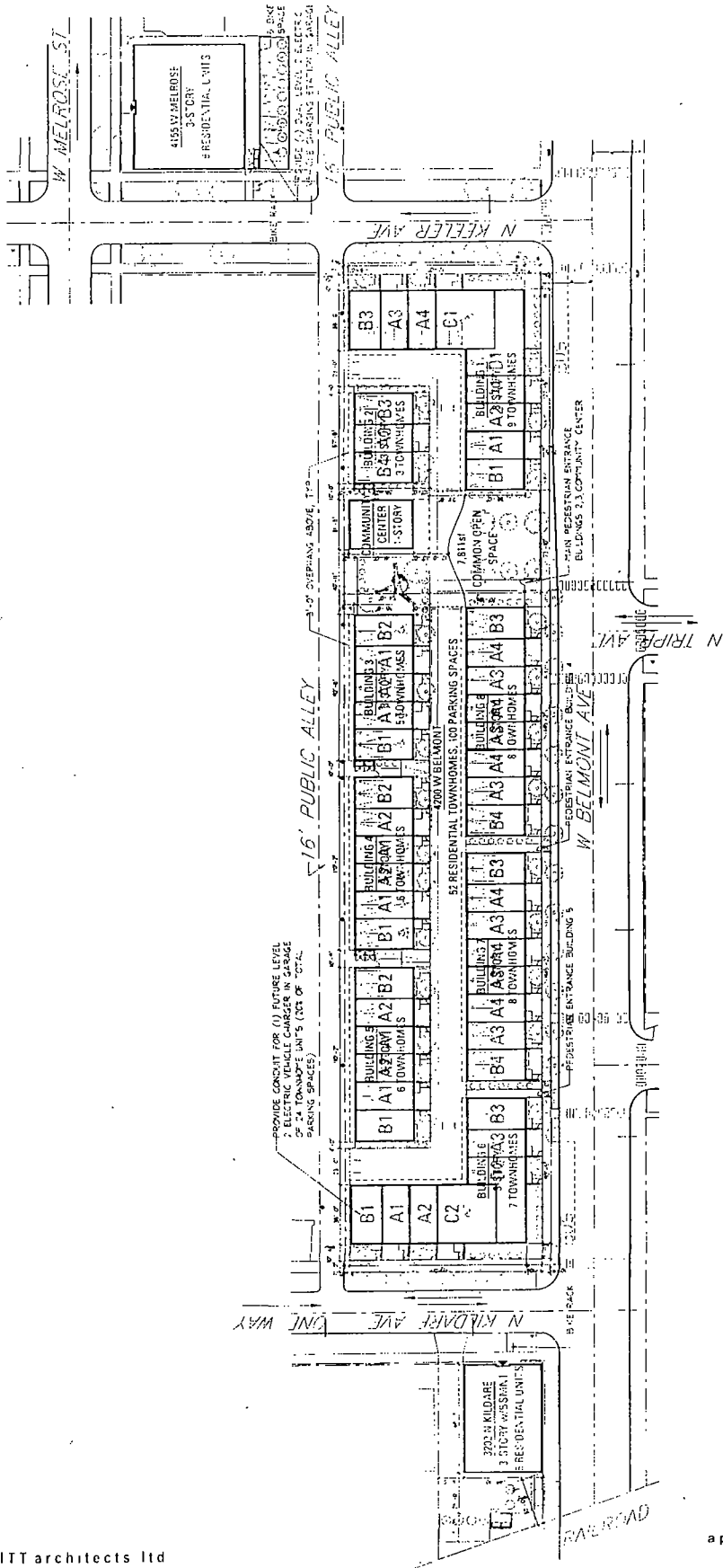

SITE PLAN

1" = 100'-0"

**jSa**  
 jonathan SPLITT architects ltd  
 4001 north ravenwood avenue  
 suite 601  
 chicago illinois 60613-2576  
 773 883 1017 fax 773 883 3081

applicant  
 address

NOAH PROPERTIES LLC  
 4200 W BELMONT AVE  
 3202 N KILDARE AVE  
 4157 W MELROSE ST  
 CHICAGO, IL 60641

intro date  
 plan commission date

02/19/2020  
 05/21/2020

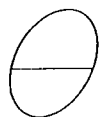

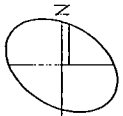
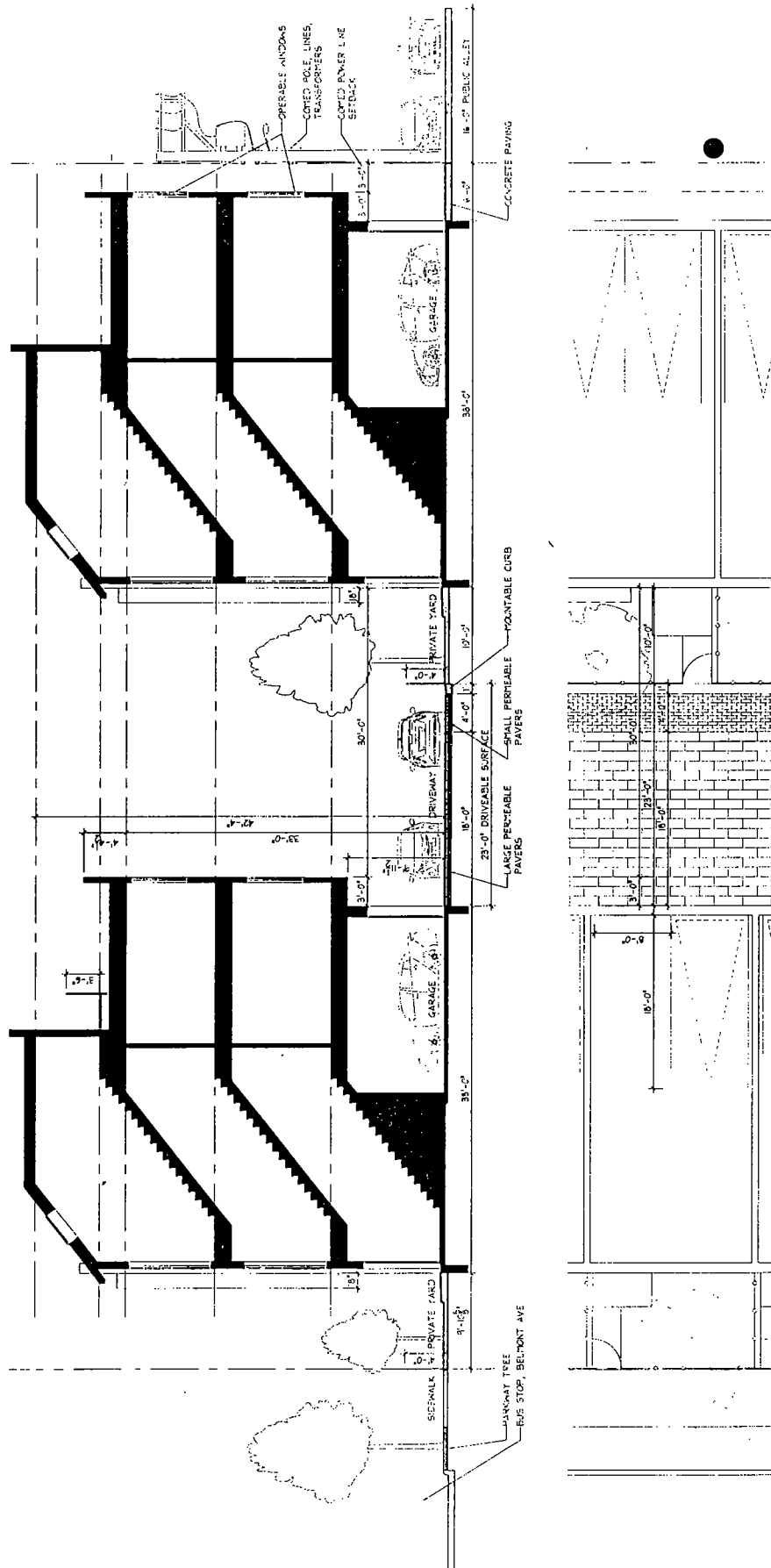

SITE SECTION & PLAN DETAIL

1/16" = 1'-0"

FINAL FOR  
PUBLICATION

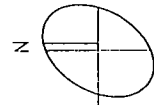
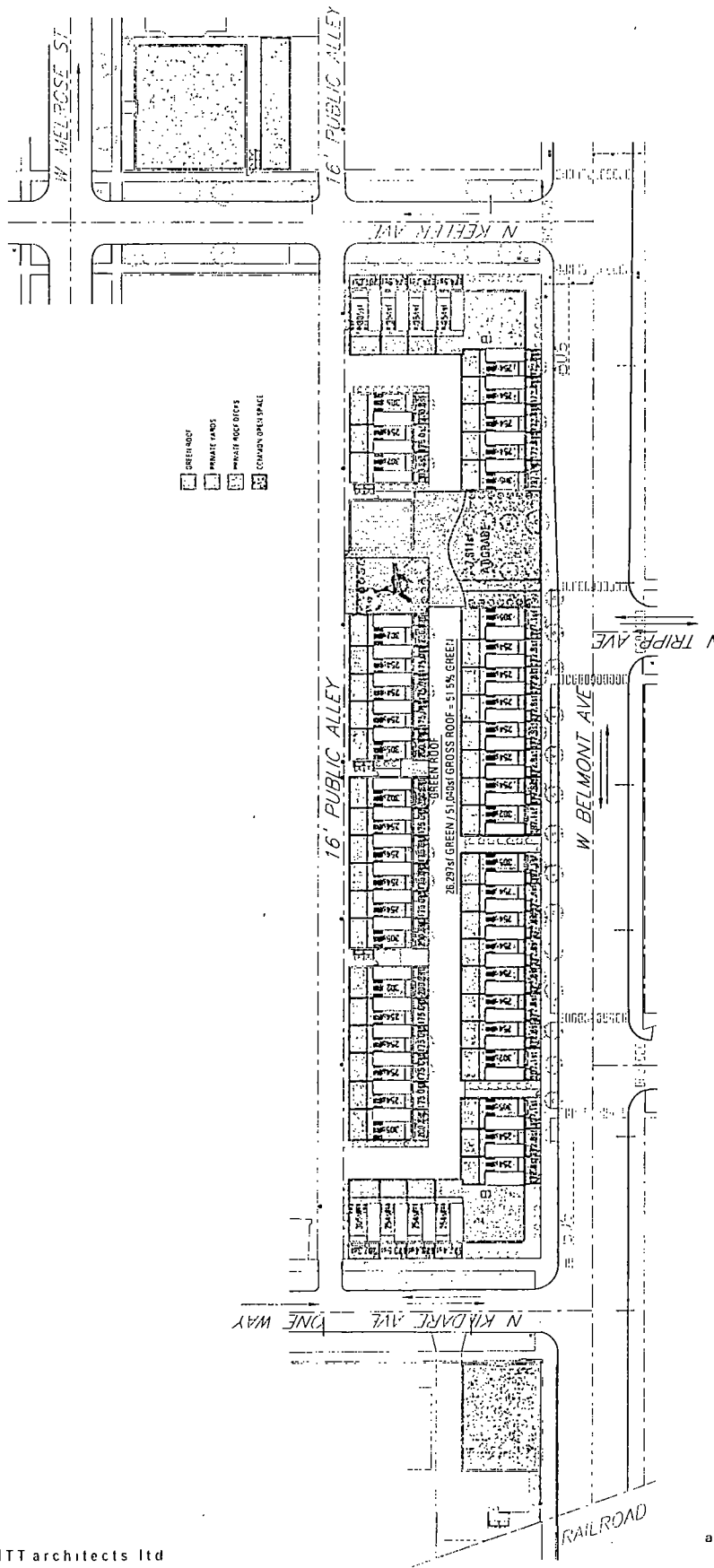

ROOF PLAN & OPEN SPACE PLAN

1" = 100'-0"

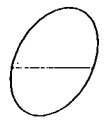

**jsa**  
Jonathan SPLITT architects ltd  
400: north ravenwood avenue  
suite 601  
chicago illinois 60613-2576  
773 883 1017 fax 773 883 3081

applicant  
address

NOAH PROPERTIES, LLC  
4206 W BELMONT AVE  
3202 N KILDARE AVE  
4157 W MELROSE ST  
CHICAGO, IL 60641

intro date  
plan commission date

02/19/2020  
05/21/2020

FINAL FOR PUBLICATION

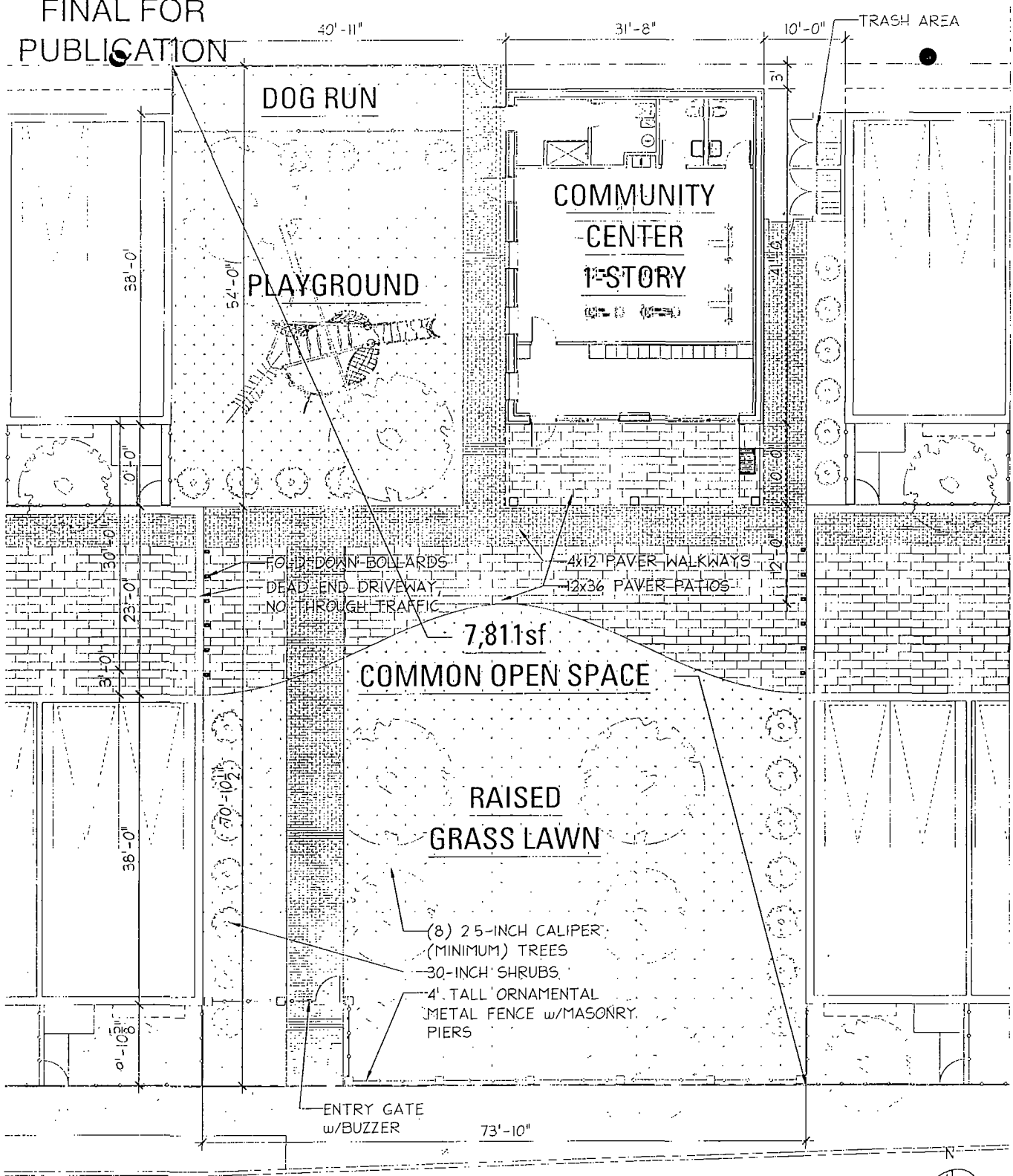

ENLARGED COMMON OPEN SPACE PLAN

1/16" = 1'-0"

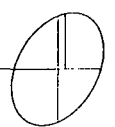

**jsa**  
 jonathan SPLITT architects ltd  
 4001 north ravenwood avenue  
 suite 501  
 chicago illinois 60613-2576  
 773 883 1017 fax 773 883 3081

applicant address

NOAH PROPERTIES, LLC  
 4200 W BFLMONT AVE  
 3202 N KILDARE AVE  
 4157 W MELROSE ST  
 CHICAGO IL 60641

intro date  
 plan commission date

02/19/2020  
 05/21/2020

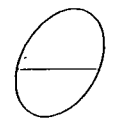



FINAL FOR PUBLICATION

16' PUBLIC

N KILDARE AVE ONE WAY

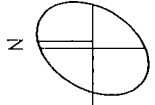
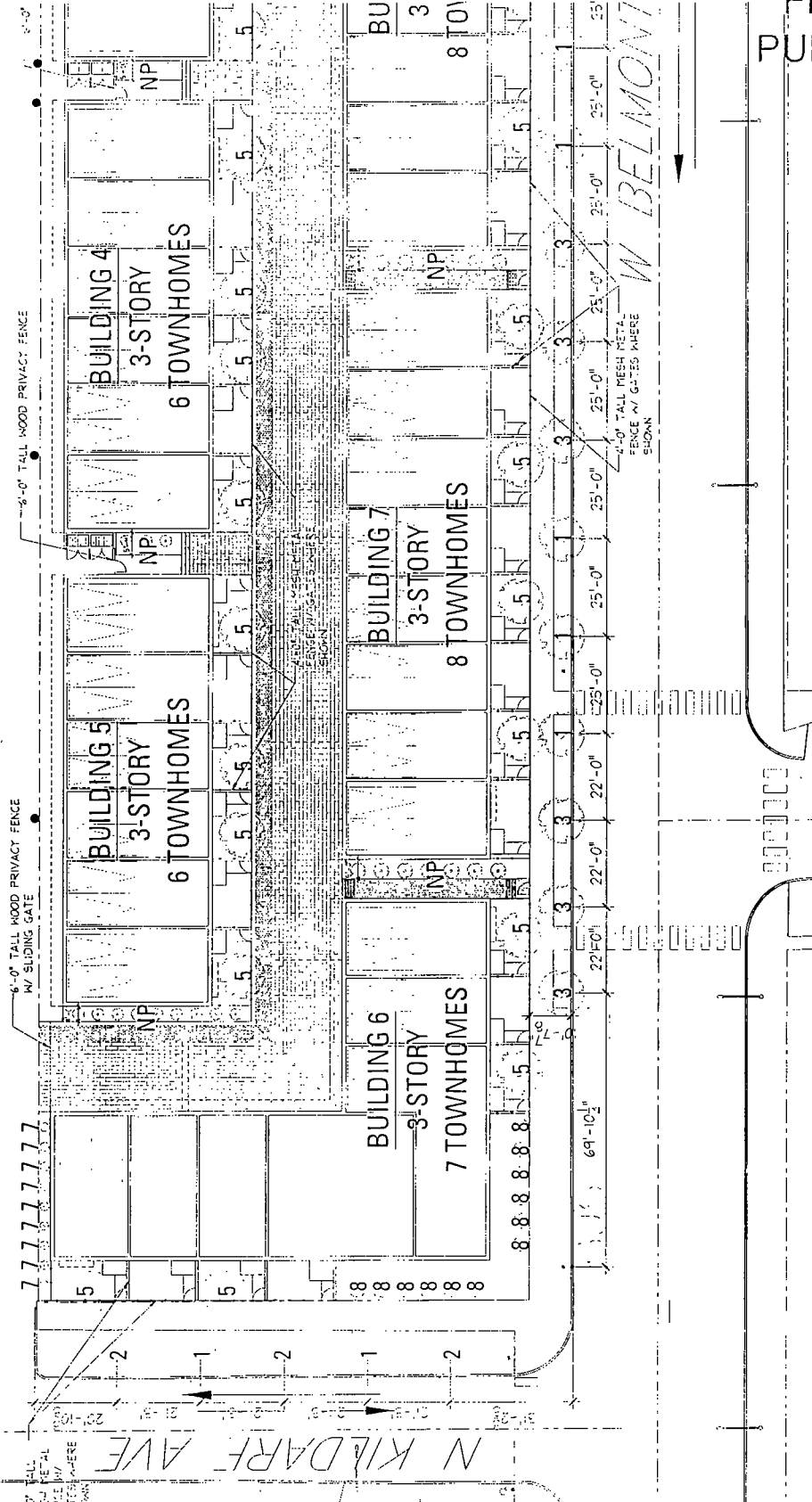

4200 BELMONT WEST LANDSCAPE PLAN

1" = 40'-0"

jSa  
 jonathan SPLITT architects ltd  
 4601 north ravenwood avenue  
 suite 601  
 Chicago Illinois 60613-2576  
 773 883 1017 fax 773 883 3081

applicant address NOAH PROPERTIES, LLC  
 4200 W BELMONT AVE  
 3202 N KILDARE AVE  
 4157 W MELROSE ST  
 CHICAGO IL 60641

intro date 02/19/2020  
 plan commission date 05/21/2020

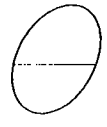

FINAL FOR PUBLICATION

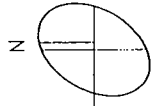
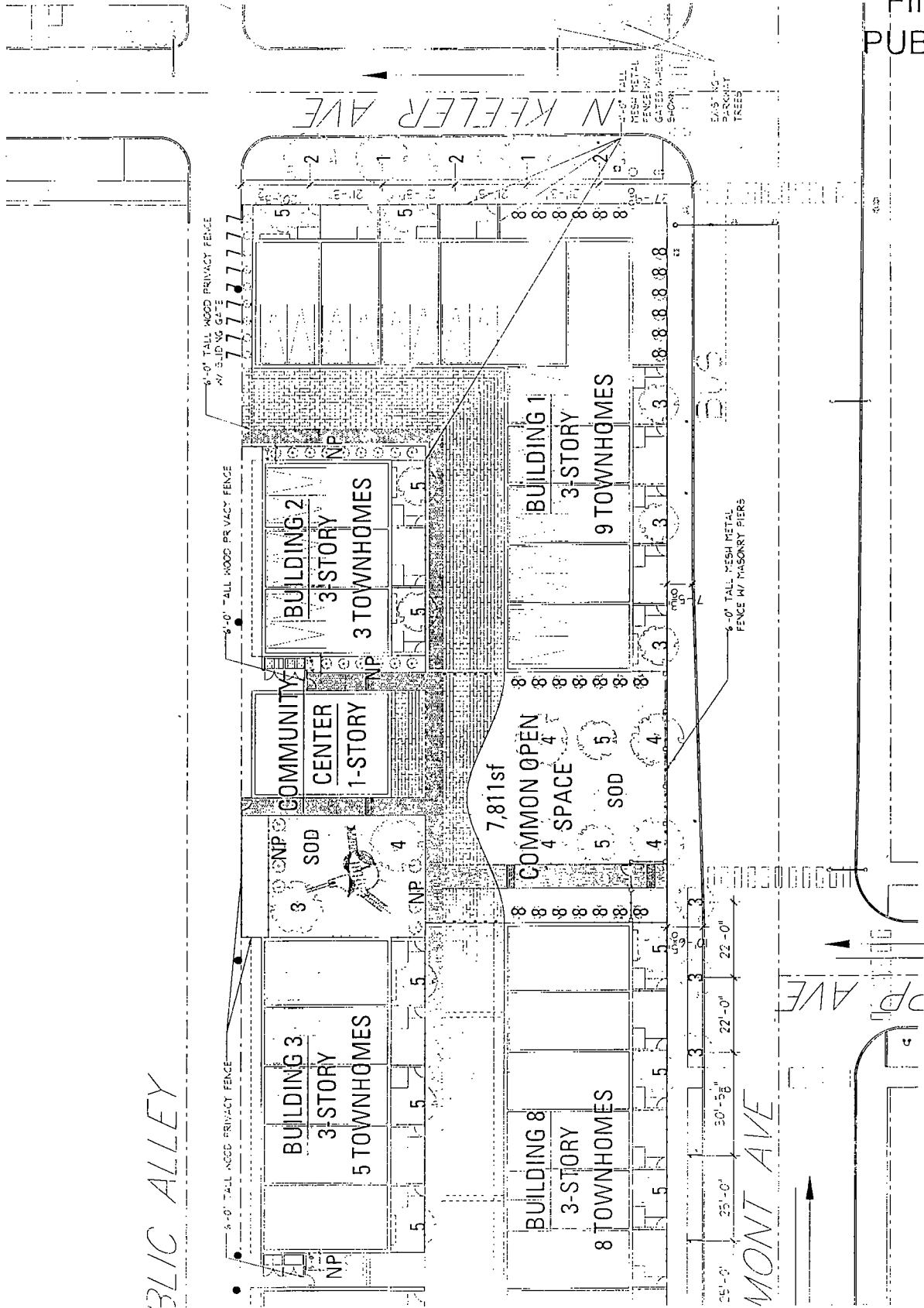

4200 BELMONT EAST LANDSCAPE PLAN

1" = 40'-0"

**jsa**  
 jonathan SPLITT architects ltd  
 4001 north ravenwood avenue  
 suite 601  
 chicago illinois 60613-2576  
 773 883 1017 fax 773 883 3081

applicant  
 address

NOAH PROPERTIES, LLC  
 4200 W BELMONT AVE  
 3202 N KILDARE AVE  
 4157 W MELROSE ST  
 CHICAGO IL 60641

intro date  
 plan commission date

02/19/2020  
 05/21/2020

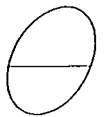

FINAL FOR PUBLICATION

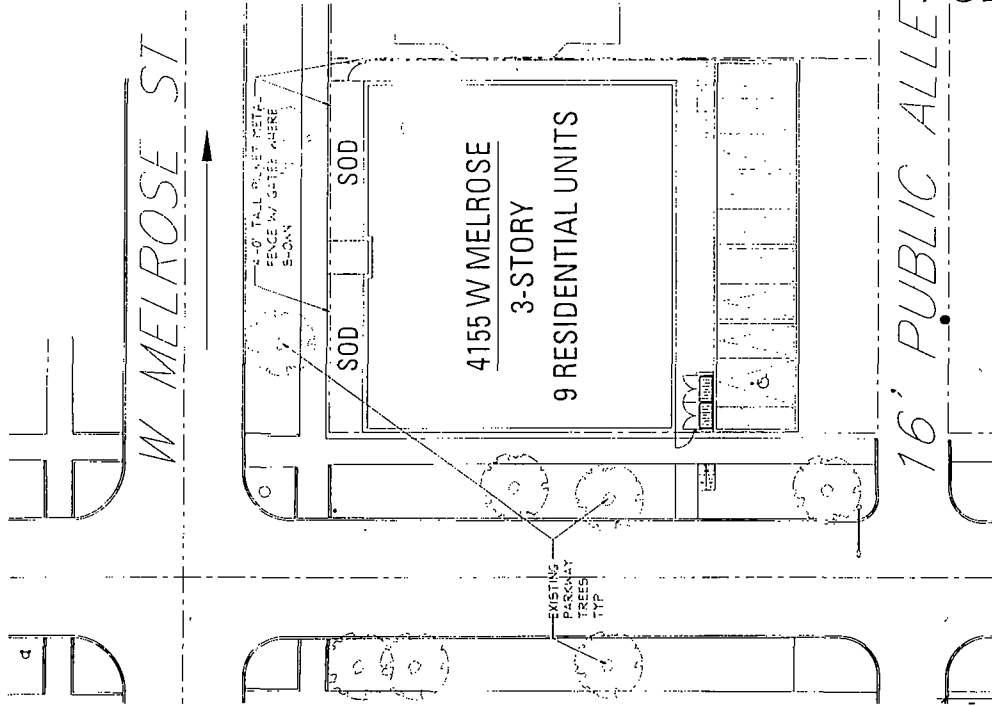
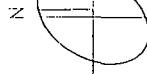

4155 MELROSE LANDSCAPE PLAN

1" = 40'-0"

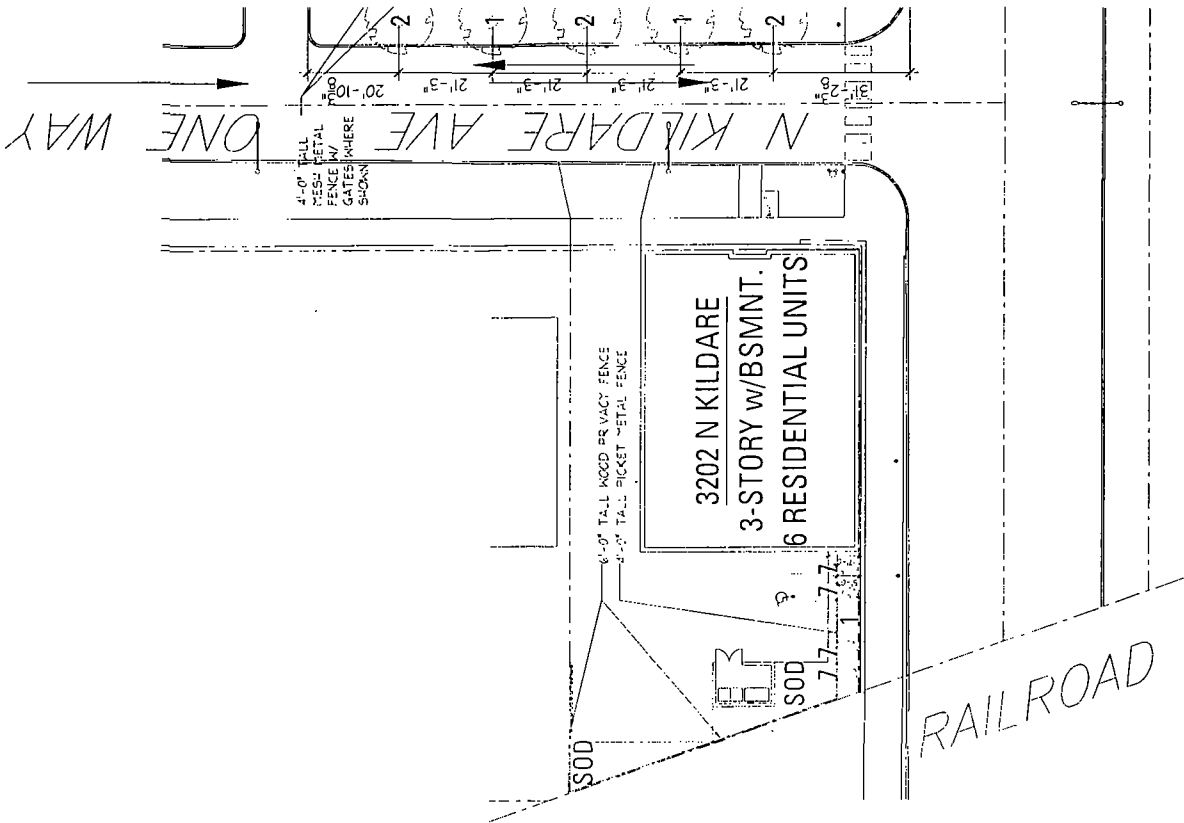

3202 KILDARE LANDSCAPE PLAN

1" = 40'-0"

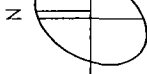

**jSa**  
 jonathan SPLITT architects ltd  
 4001 north ravenwood avenue  
 suite 501  
 chicago illinois 60613-2576  
 773 883 1017 fax 773 883 3081

applicant  
 address

NOAH PROPERTIES, LLC  
 4200 W SHLMONT AVE  
 3202 N KILDARE AVE  
 4157 W MELROSE ST  
 CHICAGO IL 60641

intro date  
 plan commission date

02/19/2020  
 05/21/2020

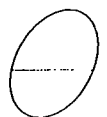

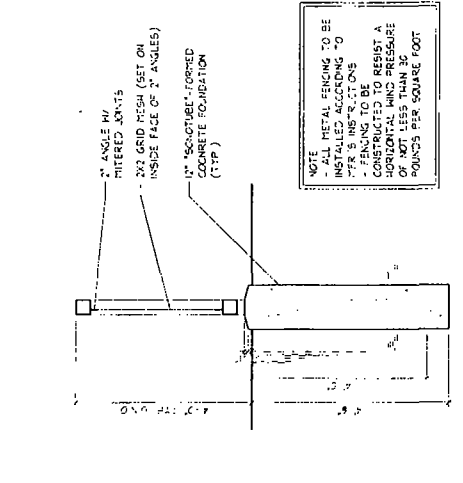
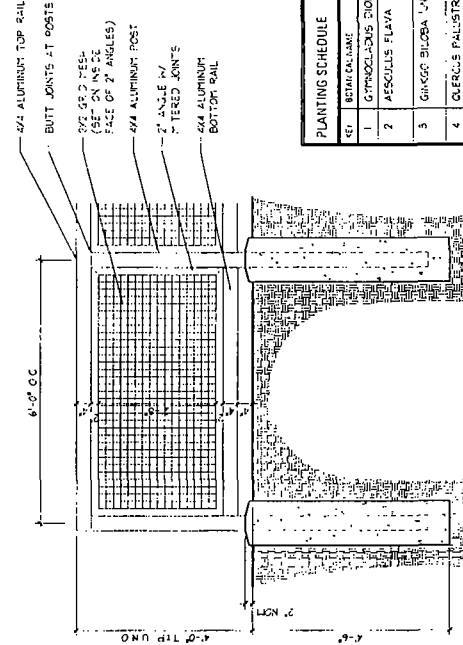
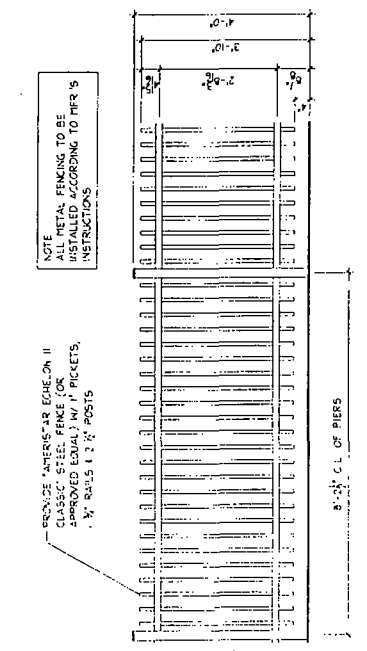
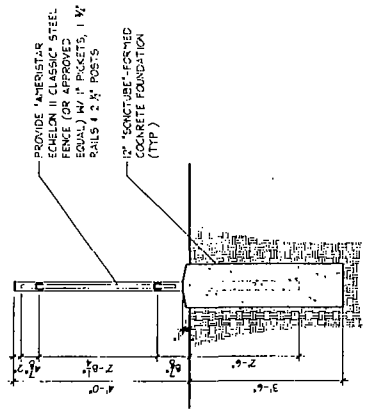

REV	DESCRIPTION	DATE	BY	CHK'D BY
1	STARTLY MANSE (KENTUCKY COFFEE)	60"	TALL	30" WIDE
2	YELLOW BUCKEYE	50"	TALL	30" WIDE
3	SKY TOWER G-MAGN	50"	TALL	30" WIDE
4	FIN OAK	40"	TALL	30" WIDE
5	MONSIEUR LINDEN	70"	TALL	30" WIDE
6	LIAC	4"	TALL	5" WIDE
7	FORSTIA X INTEREDIA	4"	TALL	5" WIDE
8	NP NATIVE PLANTINGS			
9	SD GRASS SOD			

LANDSCAPE DETAILS

N T S

**jsa**  
Jonathan SPLITT architects Ltd.  
400' north ravenwood avenue  
suite 601  
chicago illinois 60613-2576  
773 883 1017 fax 773 883 3081

applicant address  
NOAH PROPERTIES LLC  
4200 W BELMONT AVE  
3202 N KILDARE AVE  
4157 W MELROSE ST  
CHICAGO, IL 60641

intro date  
02/19/2020

plan commission date  
05/21/2020

FINAL FOR PUBLICATION

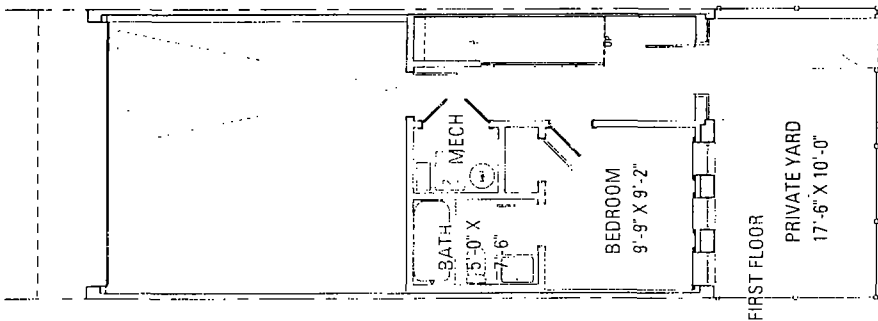
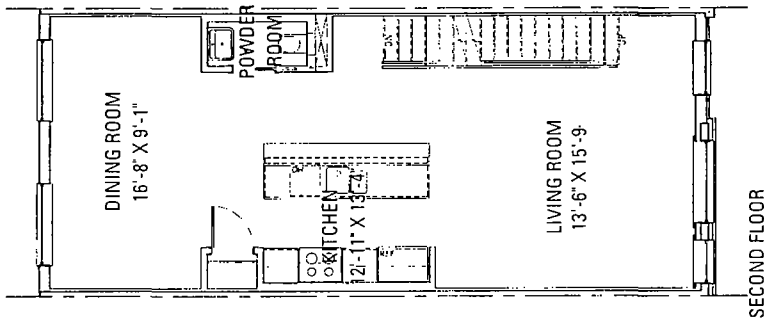
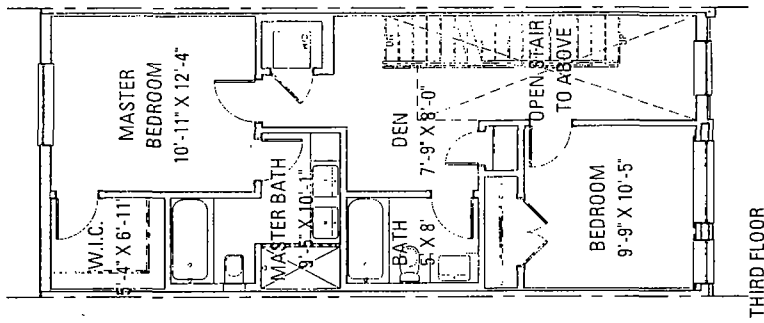
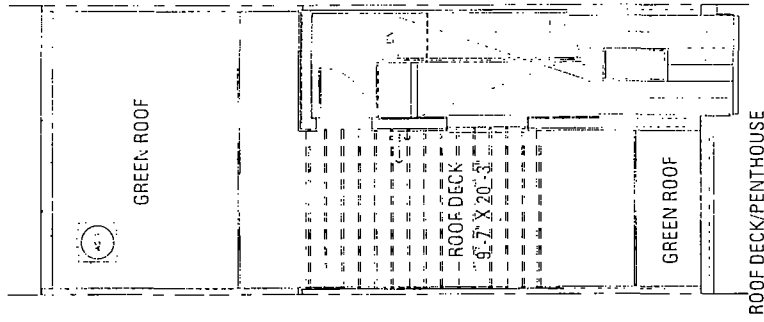

THIRD FLOOR

SECOND FLOOR

FIRST FLOOR

1,950 SQUARE FEET  
3 BEDROOM, 3.5 BATHROOM  
2 CAR GARAGE

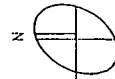

TOWNHOUSE UNIT A PLANS  
3/32" = 1'-0"

**jsa**  
jonathan SPLITT architects ltd  
4001 north ravenwood avenue  
suite 601  
chicago illinois 60613-2576  
773 883 1017 (ax 773 883 3081)

applicant NOAH PROPERTIES, LLC  
address 4200 W BELMONT AVE  
3202 N KILDARE AVE  
4157 W MELROSE ST  
CHICAGO IL 60641  
intro date 02/19/2020  
plan commission date 05/21/2020

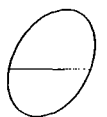

FINAL FOR  
PUBLICATION

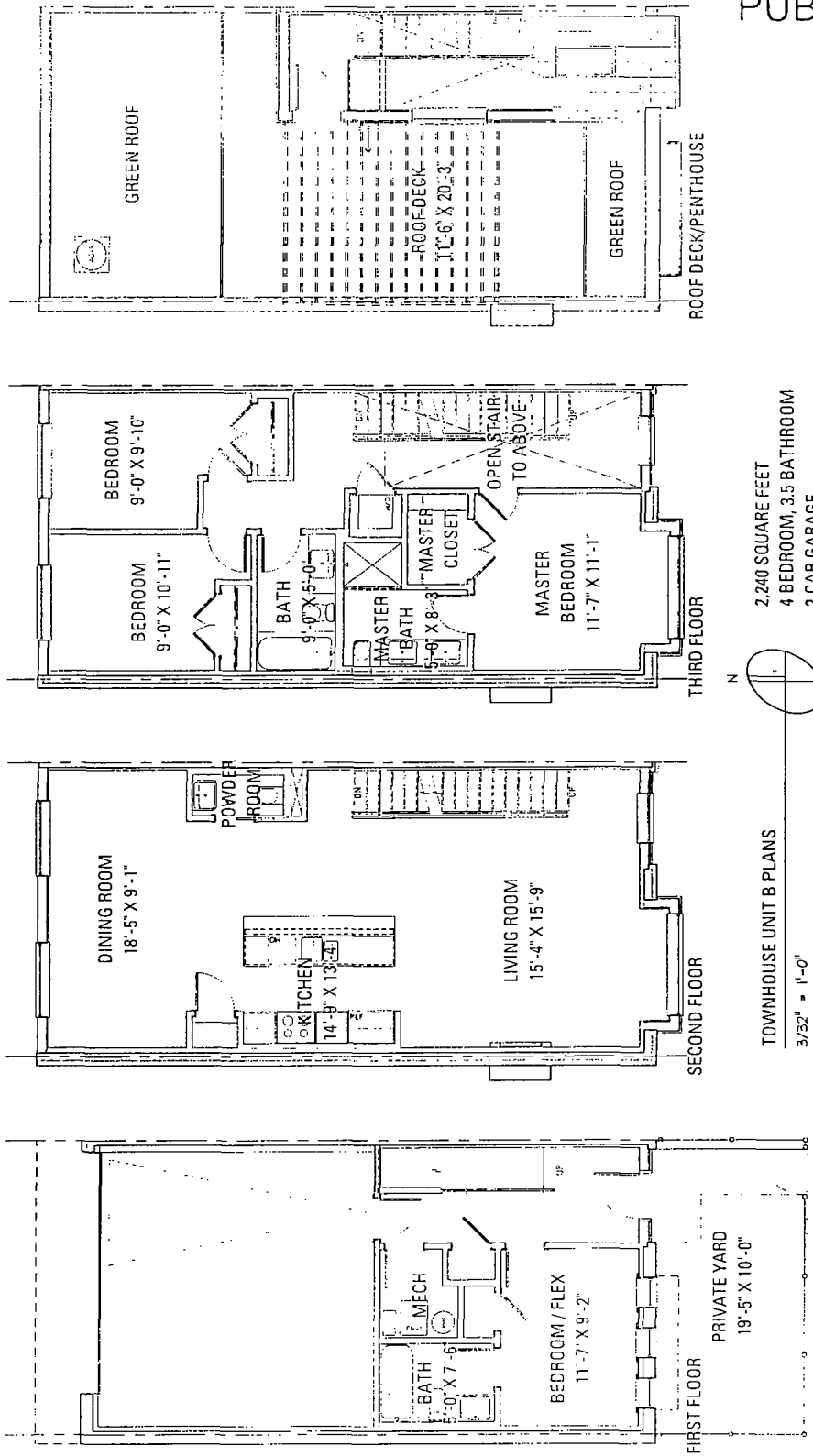

2,240 SQUARE FEET  
4 BEDROOM, 3.5 BATHROOM  
2 CAR GARAGE

TOWNHOUSE UNIT B PLANS  
3/32" = 1'-0"

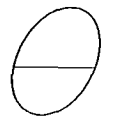
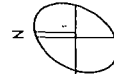

**jSa**  
Jonathan SPLITT architects Ltd.  
4001 north ravenwood avenue  
suite 601  
chicago illinois 60613-2576  
773 883 1017 fax 773 883 3081

applicant  
address

NOAH PROPERTIES, LLC  
4200 W BEECHMONT AVE  
3202 N KILDARE AVE  
4157 W MELROSE ST  
CHICAGO IL 60641

intro date  
plan commission date

02/19/2020  
05/21/2020

FINAL FOR  
PUBLICATION

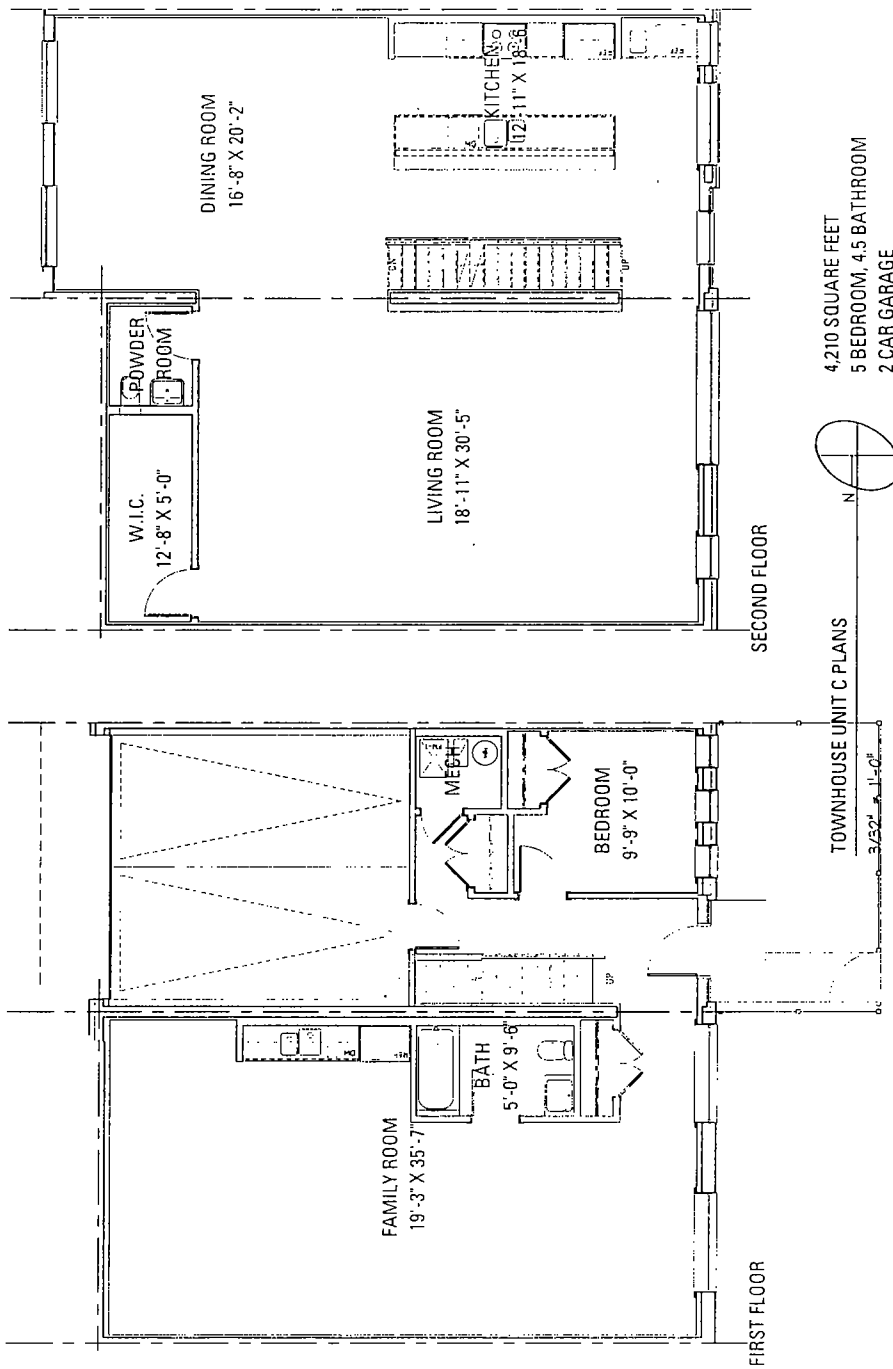

4,210 SQUARE FEET  
5 BEDROOM, 4.5 BATHROOM  
2 CAR GARAGE



TOWNHOUSE UNIT C PLANS  
3/5/20

**jsa**  
jonathan SPLITT architects ltd.  
4001 north ravenwood avenue  
suite 601  
chicago illinois 60613-2576  
773 883 1017 fax 773 883 3081

applicant	NOAH PROPERTIES, LLC
address	4200 W BELMONT AVE 3202 N KILDARE AVE 4157 W MELROSE ST CHICAGO IL 60641
intro date	02/15/2020
plan commission date	05/21/2020

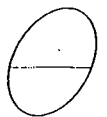

FINAL FOR PUBLICATION

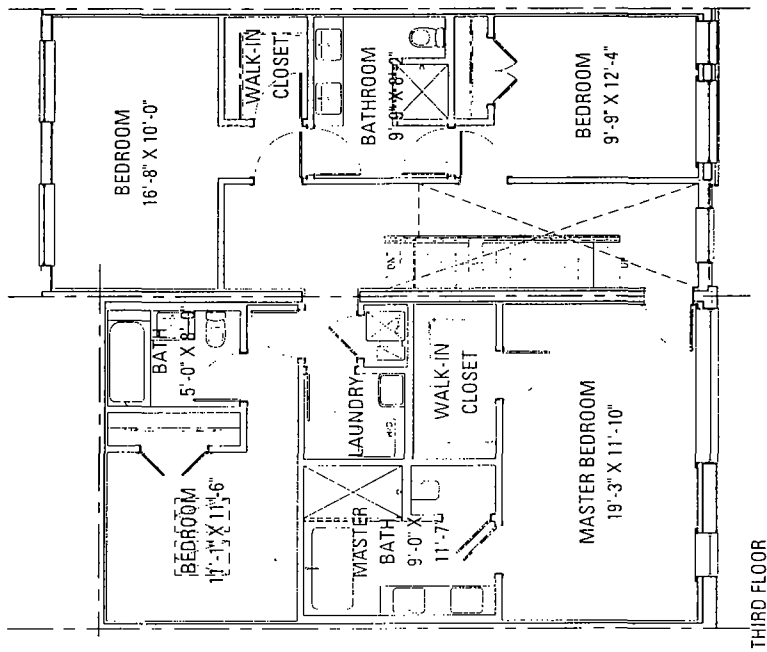
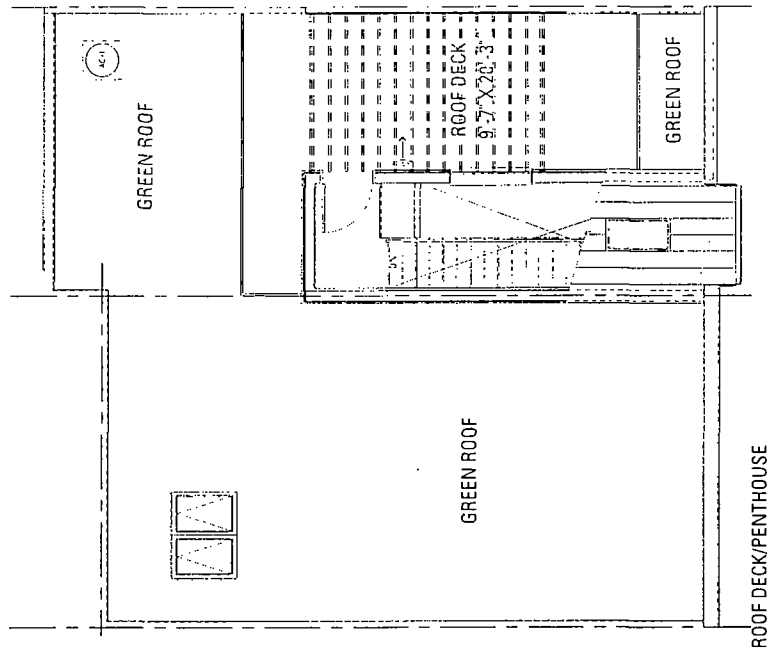

4,210 SQUARE FEET  
 5 BEDROOM, 4.5 BATHROOM  
 2 CAR GARAGE



TOWNHOUSE UNIT C PLANS  
 3/32" = 1'-0"

**jSa**  
 jonathan SPLITT architects ltd  
 400' north ravenwood avenue  
 suite 801  
 chicago illinois 60613-2576  
 773 883 1017 fax 773 883 3081

applicant NOAH PROPERTIES, LLC  
 address 4200 W BELMONT AV-  
 3202 N KILDARE AVE  
 4157 W MELHOSE ST  
 CHICAGO IL 60641  
 intro date 02/19/2020  
 plan commission date 05/21/2020

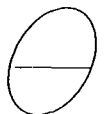



FINAL FOR  
PUBLICATION

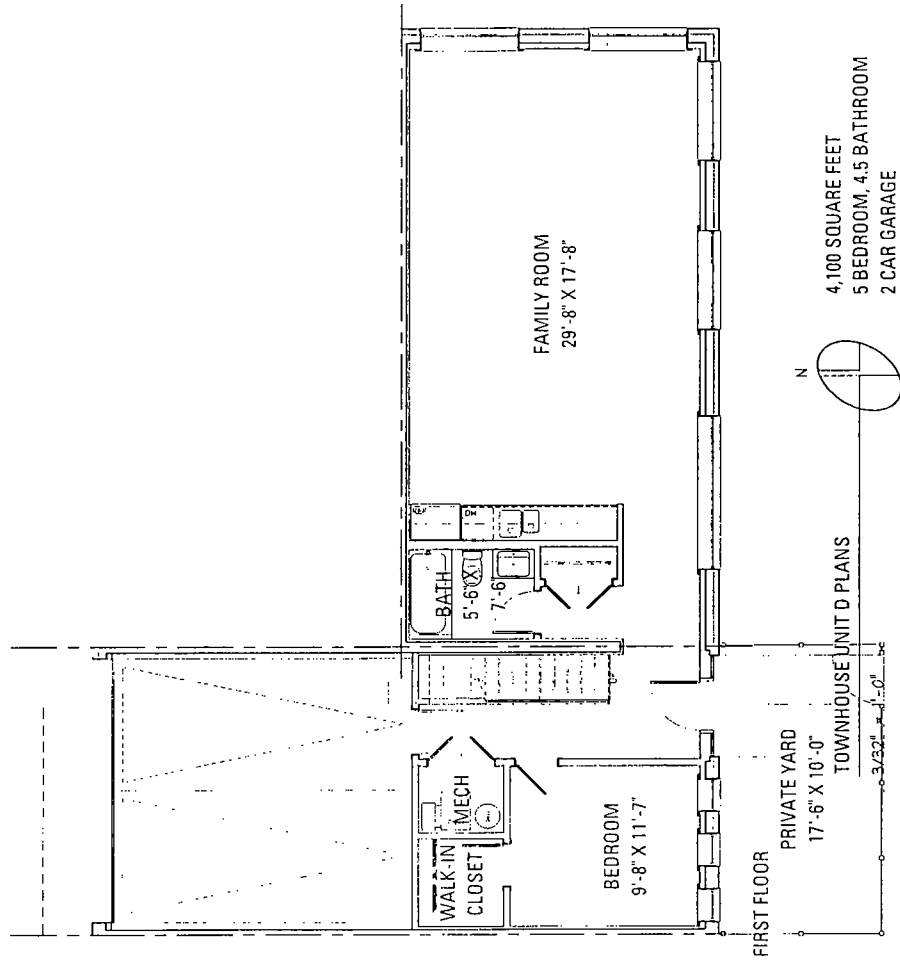

**jsa**  
Jonathan SPLITT architects ltd.  
4001 north ravenwood avenue  
suite 601  
chicago illinois 60613-2576  
773 883 1017 fax 773 883 3081

applicant address NOAH PROPERTIES, LLC  
4200 W BELMONT AVE  
3202 N KILDARE AVE  
4157 W MELROSE ST  
CHICAGO IL 60641

intro date 02/19/2020  
plan commission date 05/21/2020

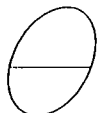

FINAL FOR  
PUBLICATION

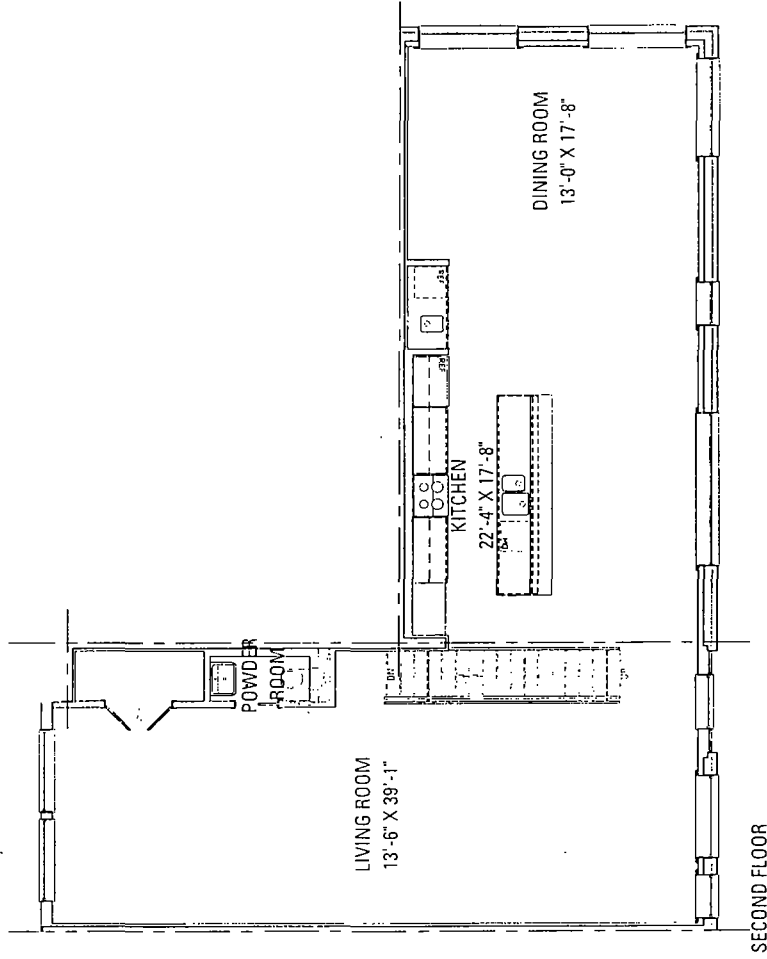

SECOND FLOOR

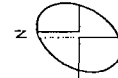

4,100 SQUARE FEET  
5 BEDROOM, 4.5 BATHROOM  
2 CAR GARAGE

TOWNHOUSE UNIT D PLANS

3/32" = 1'-0"

**jsa**

jonathan SPLITT architects ltd

4001 north ravenwood avenue  
suite 601

chicago illinois 60613-2576

773 883 1017 fax 773 883 3081

applicant  
address

NOAH PROPERTIES, LLC  
4200 W BELMONT AVE  
3202 N KILDARE AVE  
4157 W MELROSE ST  
CHICAGO IL 60641

intro date  
plan commission date

02/19/2020  
05/21/2020

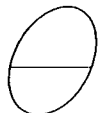

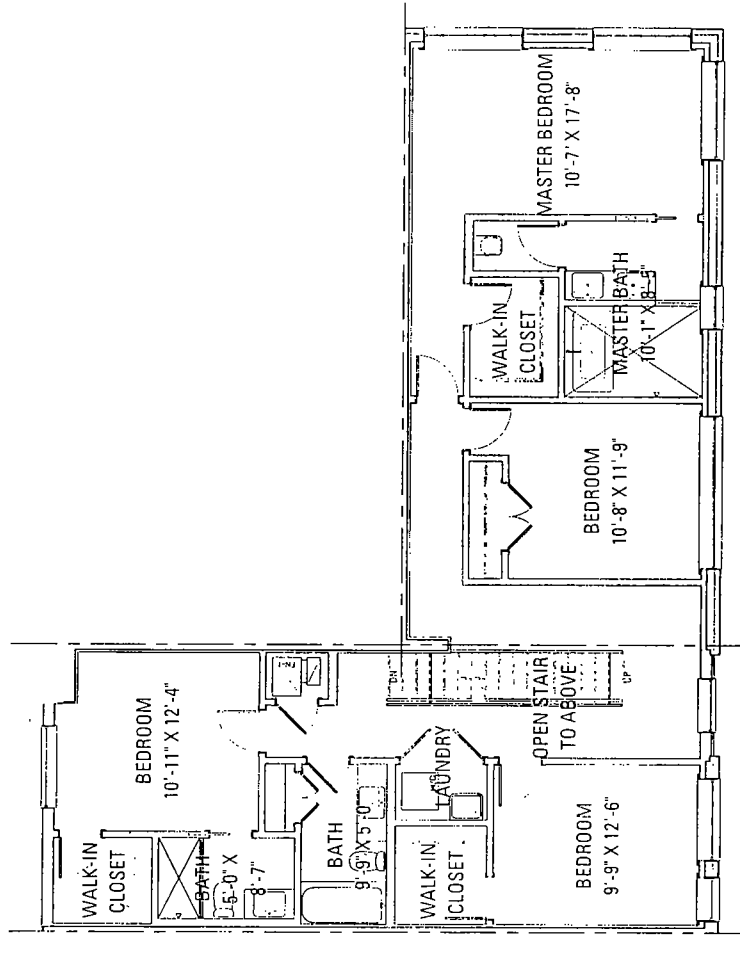

THIRD FLOOR

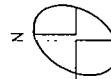

4,100 SQUARE FEET  
5 BEDROOM, 4.5 BATHROOM  
2 CAR GARAGE

TOWNHOUSE UNIT D PLANS

3/32" = 1'-0"

**jSa**  
Jonathan SPLITT architects Ltd.  
4001 north ravenwood avenue  
suite 501  
chicago illinois 60613-2576  
773 883 1017 fax 773 883 3081

applicant address NOAH PROPERTIES, LLC  
4200 W BELMONT AVE  
3202 N KILDARE AVE  
4157 W MELROSE ST  
CHICAGO IL 60641  
intro date 02/19/2020  
plan commission date 05/21/2020

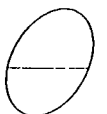

FINAL FOR  
PUBLICATION

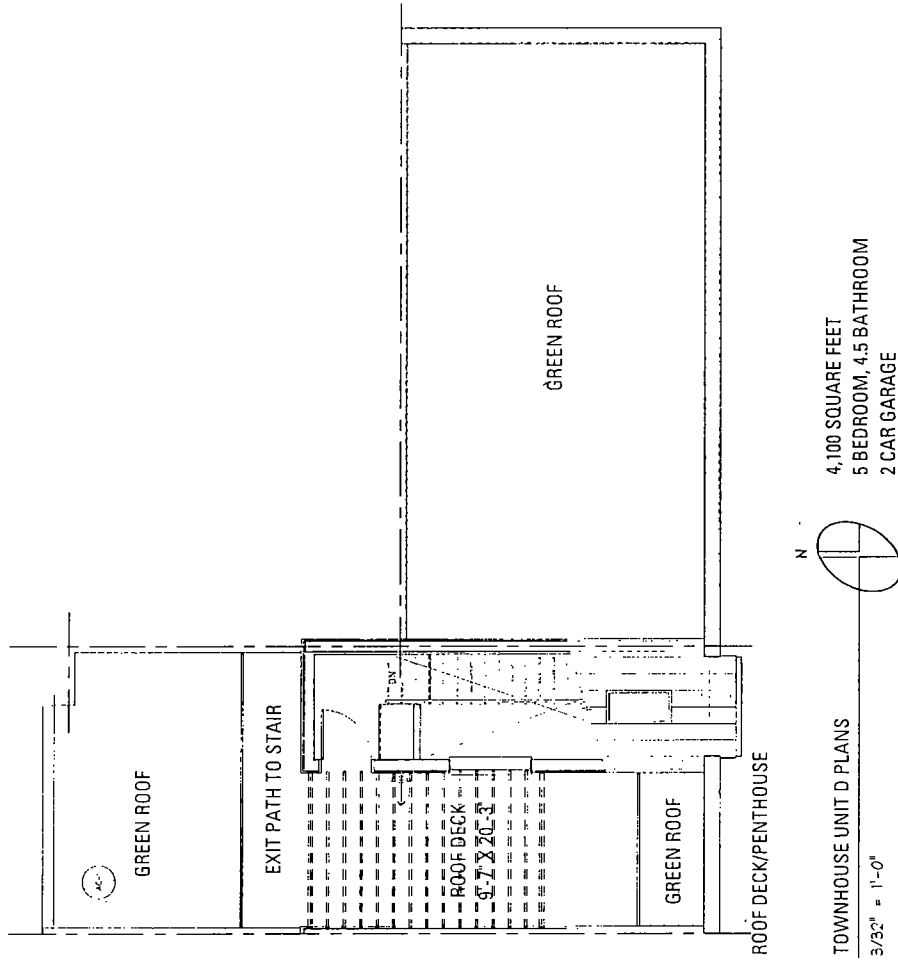

**jSa**  
 jonathan SPLITT architects ltd  
 4001 north ravenwood avenue  
 suite 601  
 chicago illinois 606132576  
 773 883 1017 fax 773 883 3081

applicant	NOAH PROPERTIES, LLC
address	4200 W BELMONT AVE 3202 N KIL DANE AVE 4157 W MELROSE ST CHICAGO IL 60641
intro date	02/19/2020
plan commission date	05/21/2020

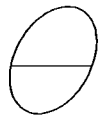

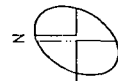
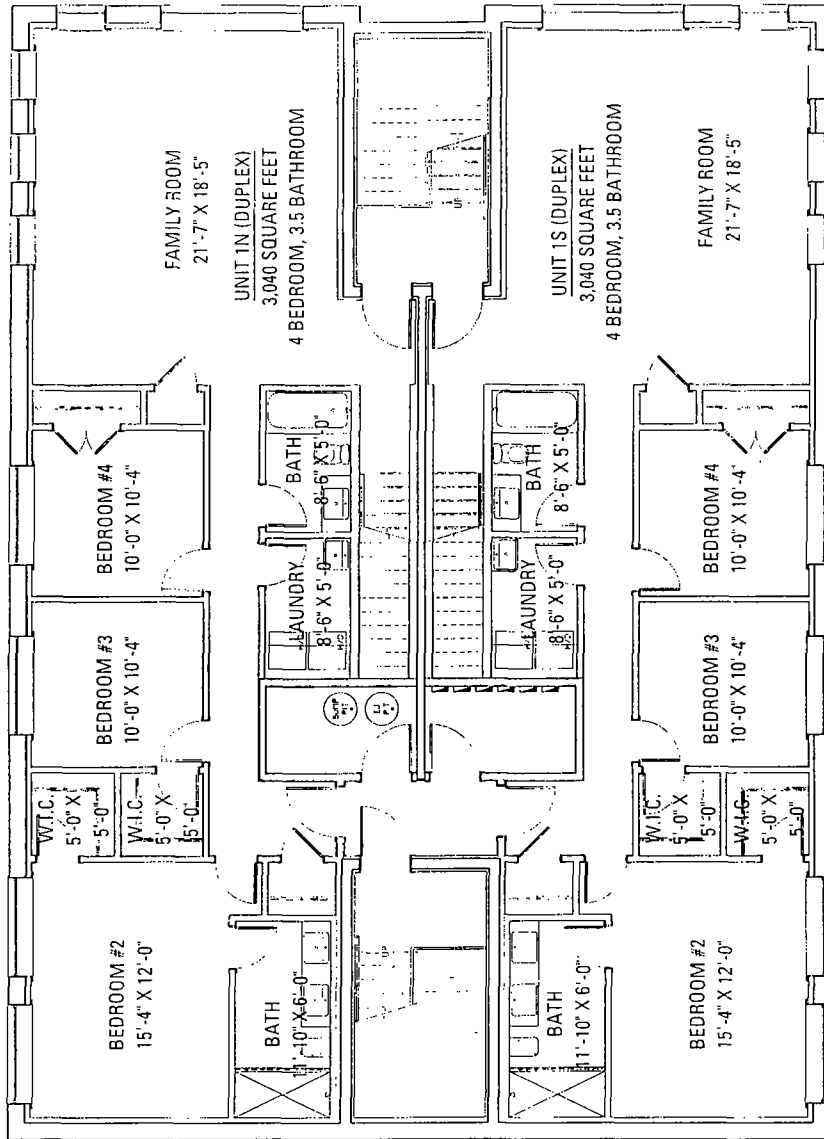

BASEMENT  
3202 N KILDARE PLANS  
5/32" = 1'-0"

**jSa**

Jonathan SPLITT architects ltd  
4081 north ravenwood avenue  
suite 601  
chicago illinois 60613-2576  
773 883 1017 fax 773 883 3081

applicant  
address

NOAH PROPERTIES, LLC  
4200 W BELMONT AVE  
3202 N KILDARE AVE  
4157 W MELROSE ST  
CHICAGO IL 60641

intro date  
plan commission date

02/19/2020  
05/21/2020

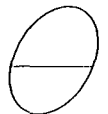

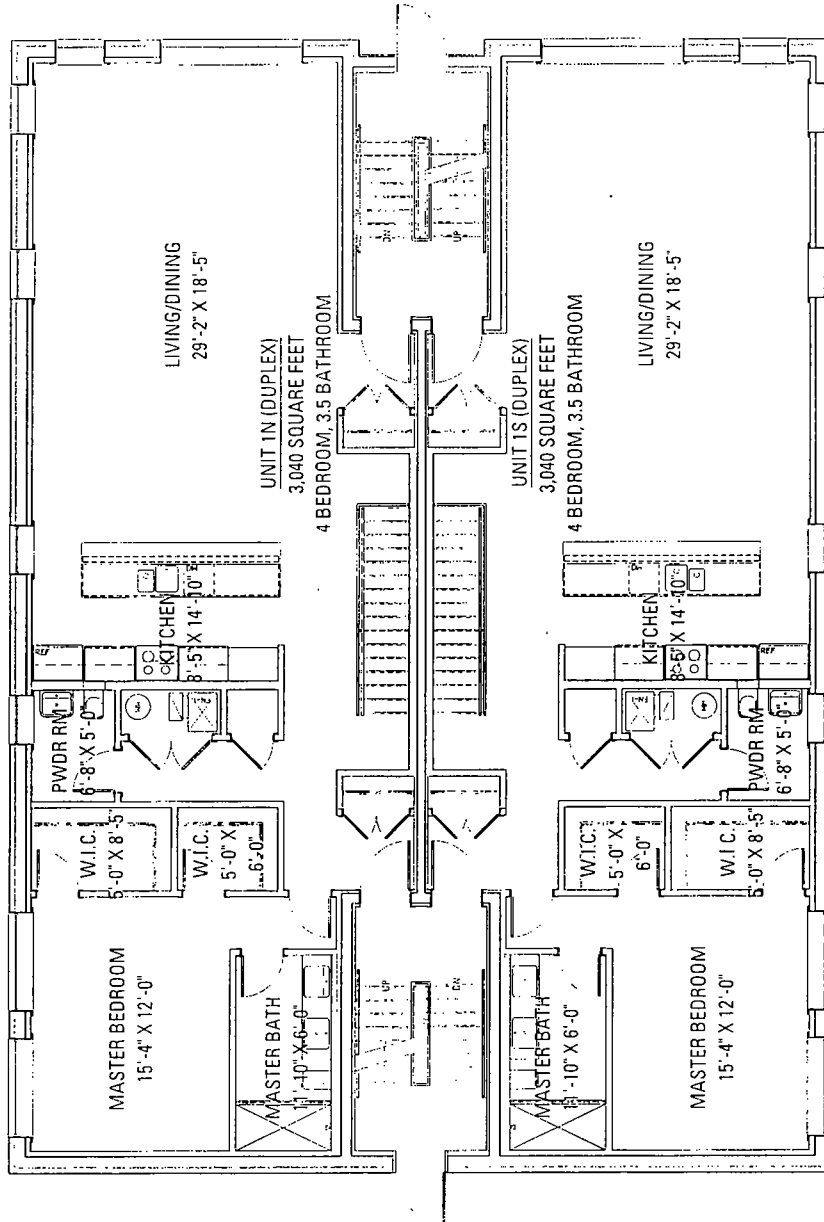

FIRST FLOOR  
3202 N KILDARE PLANS  
3/32" = 1'-0"

**jsa**  
jonathan SPLITT architects ltd.  
400: north ravenwood avenue  
suite 601  
chicago illinois 60613-2576  
773 883 1017 fax 773 883 3081

applicant address  
intro date  
plan commission date

NOAH PROPERTIES, LLC  
4200 W BELMONT AVE  
3202 N KILDARE AVE  
4157 W MELROSE ST  
CHICAGO IL 60641  
02/19/2020  
05/21/2020

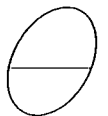

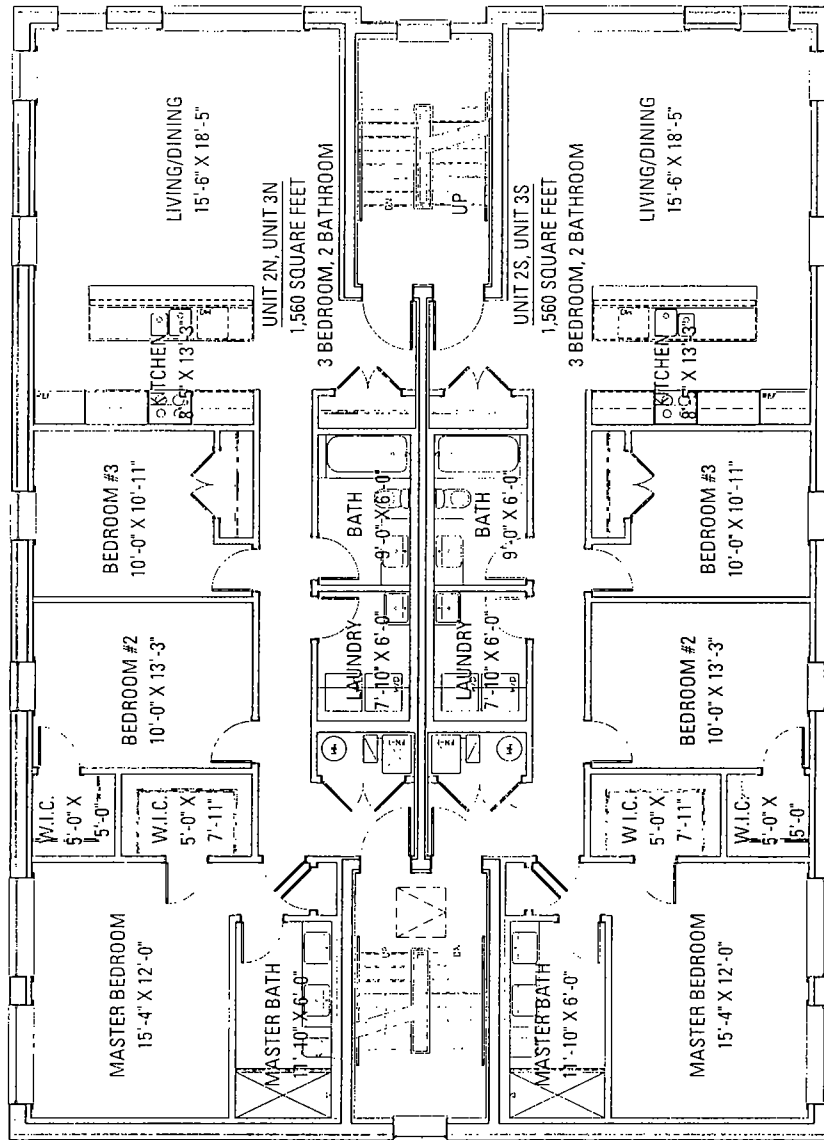

SECOND/THIRD FLOOR  
3202 N KILDARE PLANS  
3/32" = 1'-0"

**jSa**  
jonathan SPLITT architects ltd  
4001 north ravenwood avenue  
suite 601  
chicago illinois 60613-2576  
773 883 1017 fax 773 883 3081

applicant	NOAH PROPERTIES, LLC
address	4200 W BELMONT AVE 3202 N KILDARE AVE 4157 W MELROSE ST CHICAGO IL 60641
intro date	02/19/2020
plan commission date	05/21/2020

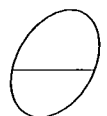

FINAL FOR  
PUBLICATION

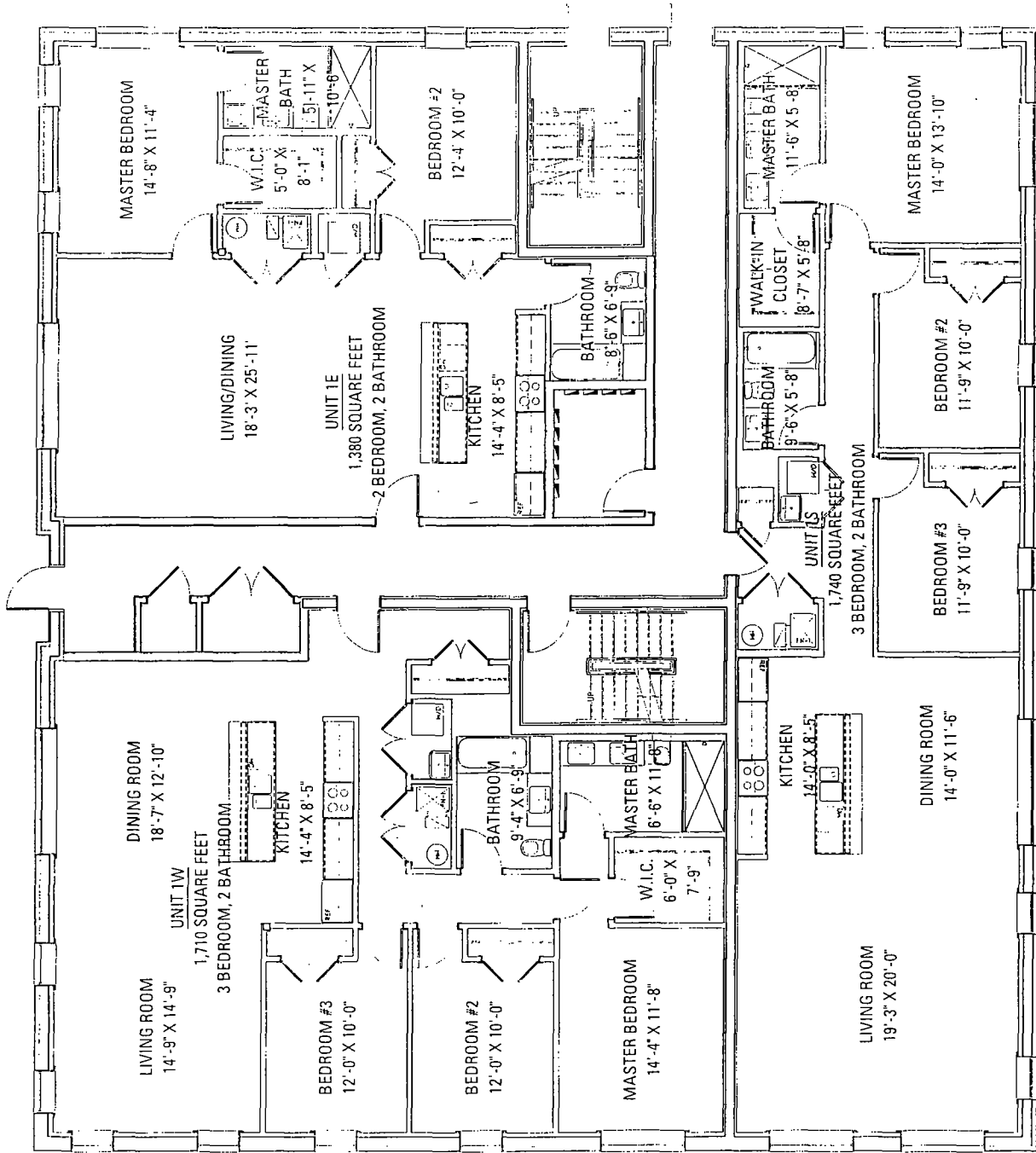

FIRST FLOOR  
4155 W MELROSE PLANS  
3/32" = 1'-0"

**jsa**  
Jonathan SPLITT architects ltd  
4001 north ravenwood avenue  
suite 501  
chicago illinois 60613-2576  
773 883 1017 fax 773 883 3081

applicant NOAH PROPERTIES, LLC  
address 4200 W BELMONT AVE  
3202 N KILDARE AVE  
4157 W MELROSE ST  
CHICAGO IL 60641  
intro date 02/19/2020  
plan commission date 05/21/2020

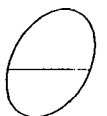



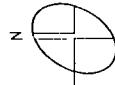
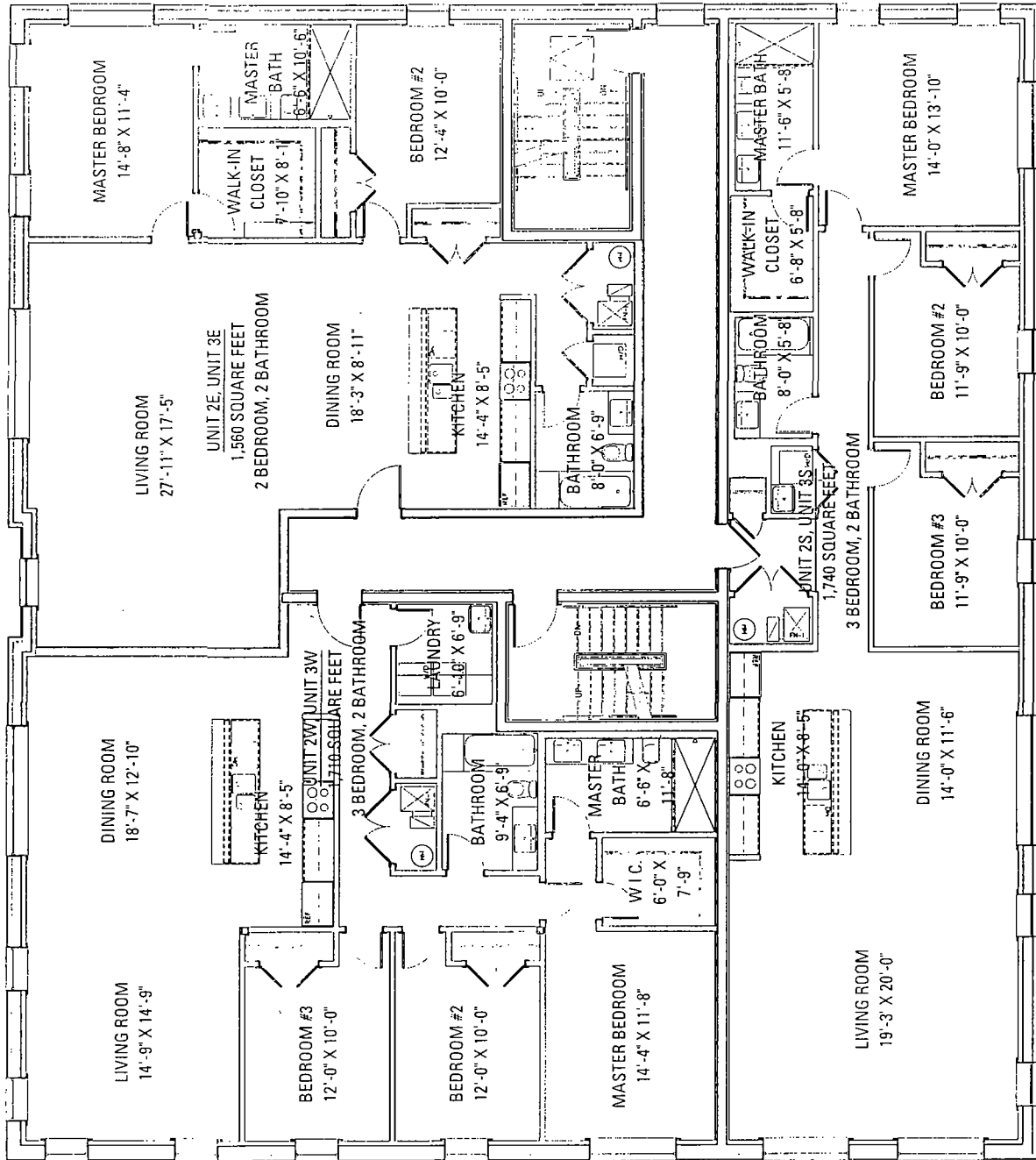

SECOND/THIRD FLOOR  
4155 W MELROSE PLANS  
3/22' = 1'-0"

**jSa**  
jonathan SPLITT architects ltd.  
4001 north raverswood avenue  
suite 601  
chicago illinois 60613-2576  
773 883 1017 fax 773 883 3081

applicant NOAH PROPERTIES, LLC  
address 4200 W BELMONT AVE  
3202 N KILDARE AVE  
4157 W MELROSE ST  
CHICAGO IL 60641  
Intro date 02/19/2020  
plan commission date 05/21/2020

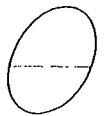

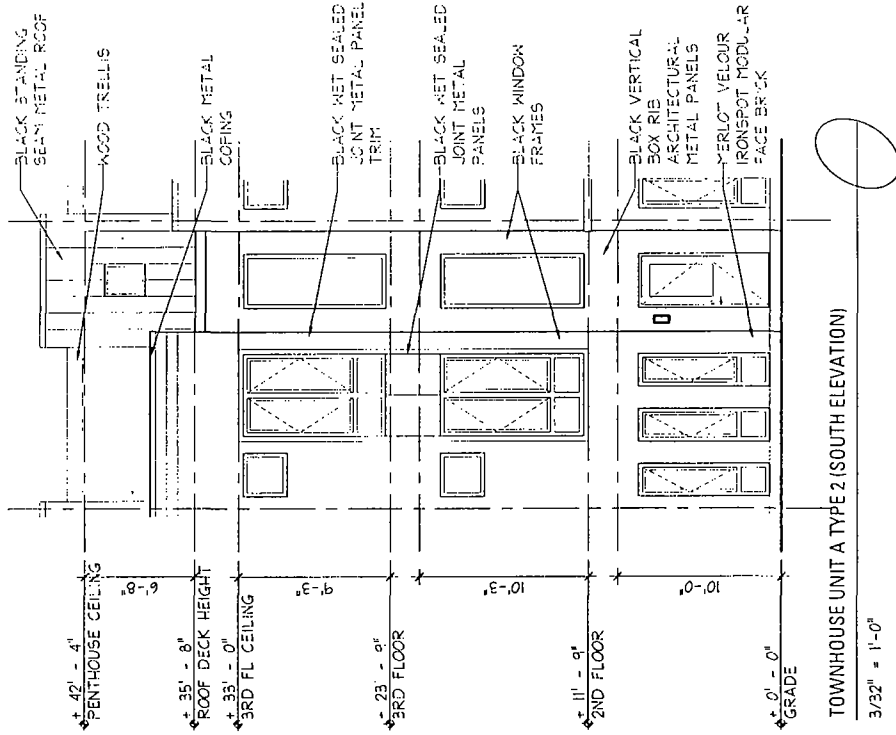

TOWNHOUSE UNIT A TYPE 2 (SOUTH ELEVATION)  
3/22" = 1'-0"

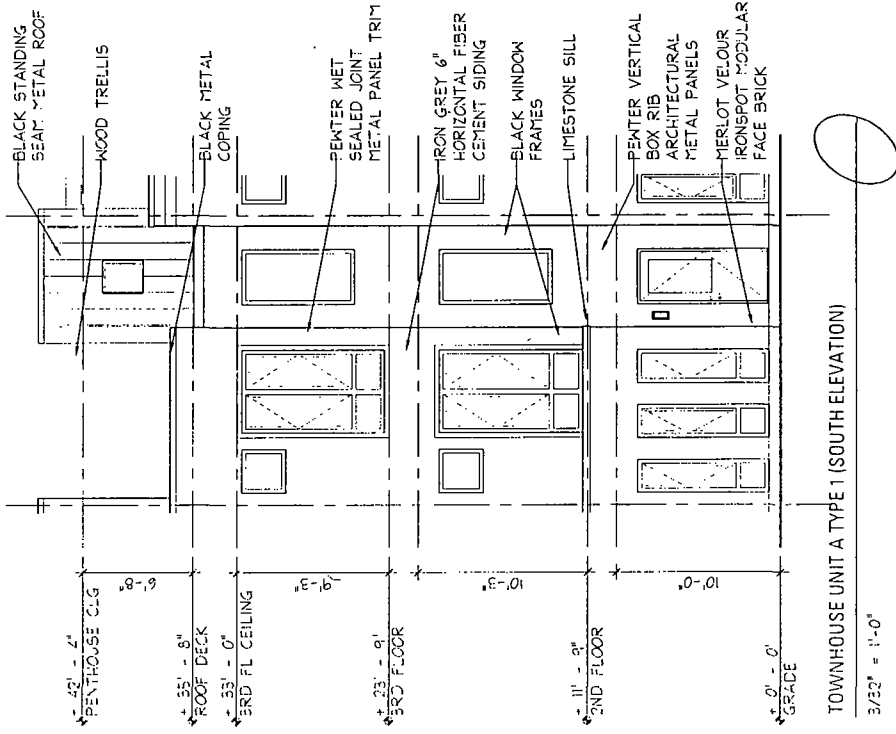

TOWNHOUSE UNIT A TYPE 1 (SOUTH ELEVATION)  
3/22" = 1'-0"

**jsa**  
 jonathan SPLITT architects ltd  
 4001 north ravenwood avenue  
 suite 601  
 chicago illinois 60613-2576  
 773 883 1017 fax 773 883 3081

applicant address NOAH PROPERTIES, I.L.C.  
 4200 W BELMONT AVE  
 3202 N KILDARE AVE  
 4157 W MELROSE ST  
 CHICAGO IL 60641  
 intro date 02/19/2020  
 plan commission date 05/21/2020

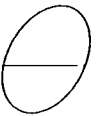

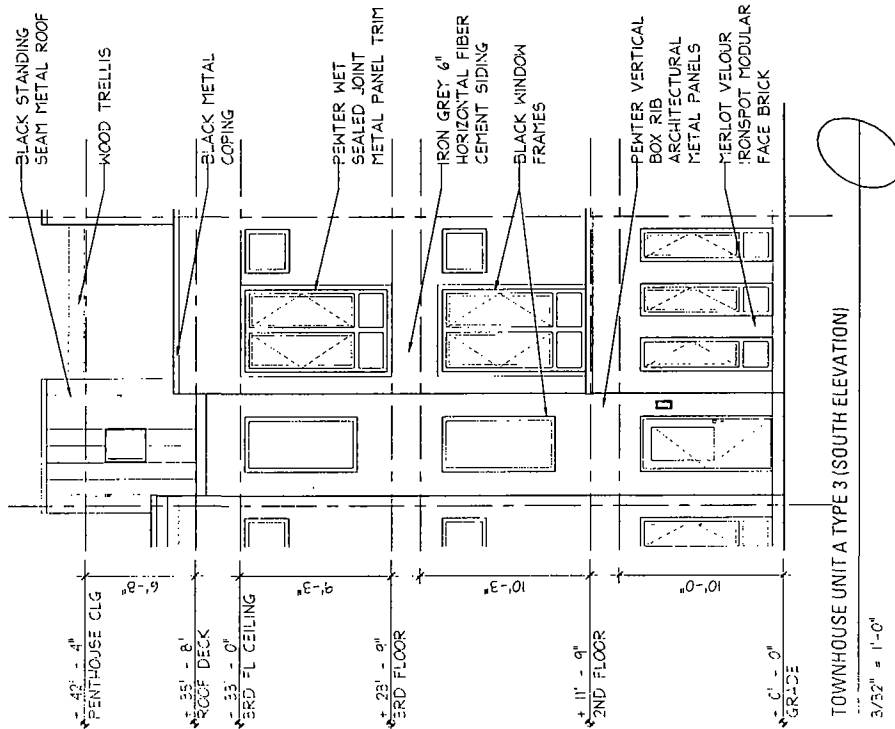
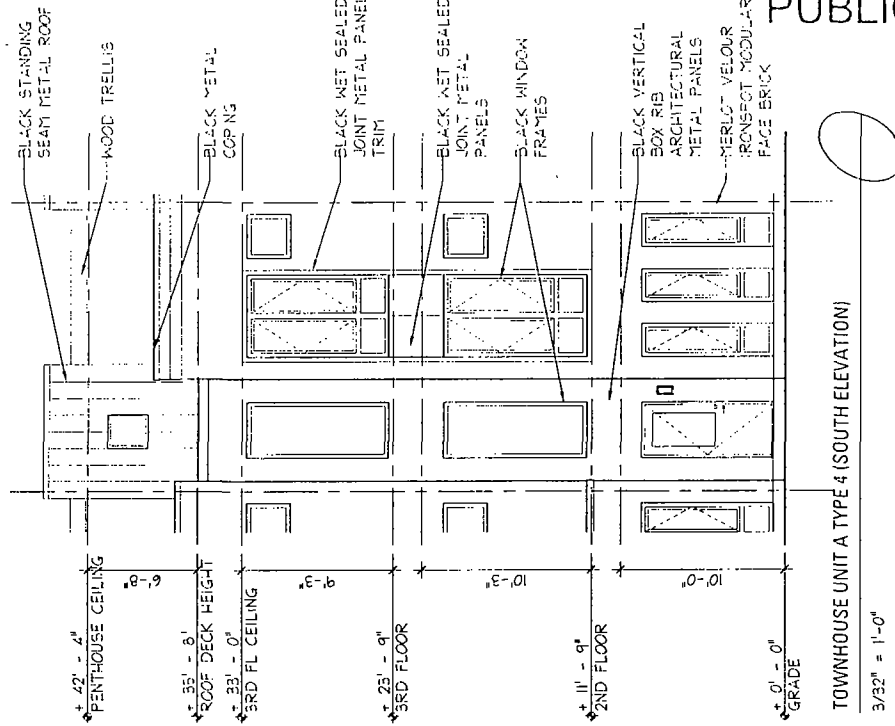

**jSa**  
 jonathan SPLITT architects ltd  
 4001 north ravenwood avenue  
 suite 601  
 chicago illinois 60613-2576  
 773 883 1017 fax 773 883 3081

applicant address NOAH PROPERTIES, L.L.C.  
 4200 W BELMONT AVE  
 3202 N KILDARE AVE  
 4157 W MELROSE ST  
 CHICAGO IL 60641  
 intro date 02/19/2020  
 plan commission date 05/21/2020

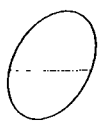

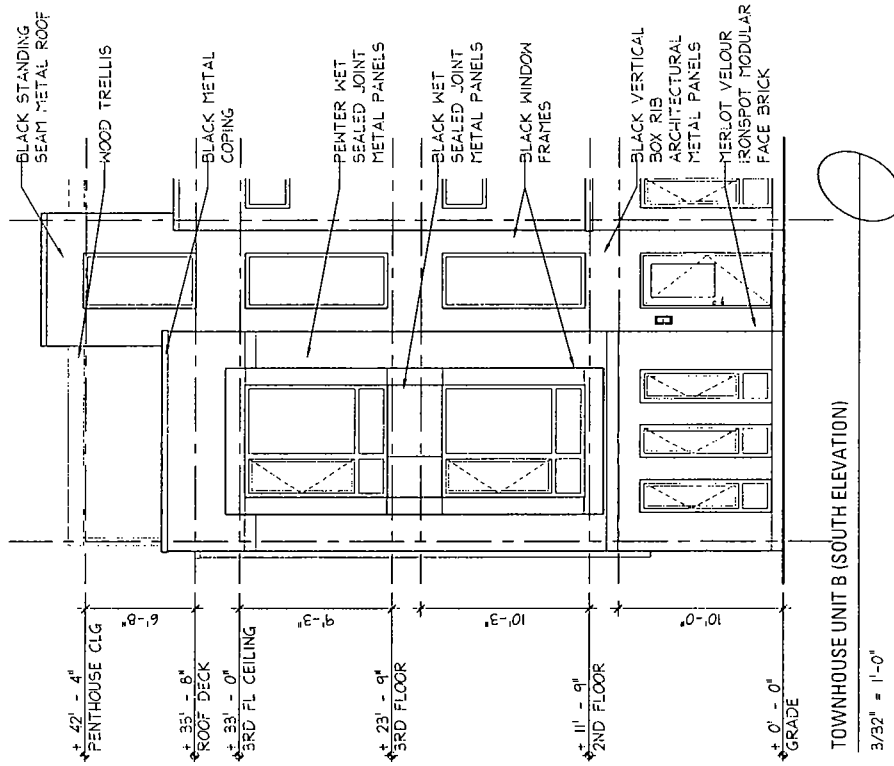

**JSa**

Jonathan SPLITT architects ltd  
4001 north Ravenswood avenue  
suite 601  
chicago illinois 60613-2576  
773 883 1017 fax 773 883 3081

applicant  
address

NOAH PROPERTIES, LLC  
4200 W BELMONT AVE  
3202 N KILDARE AVE  
4157 W MELROSE ST  
CHICAGO IL 60641

intro date  
plan commission date

02/19/2020  
05/21/2020

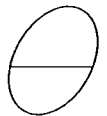

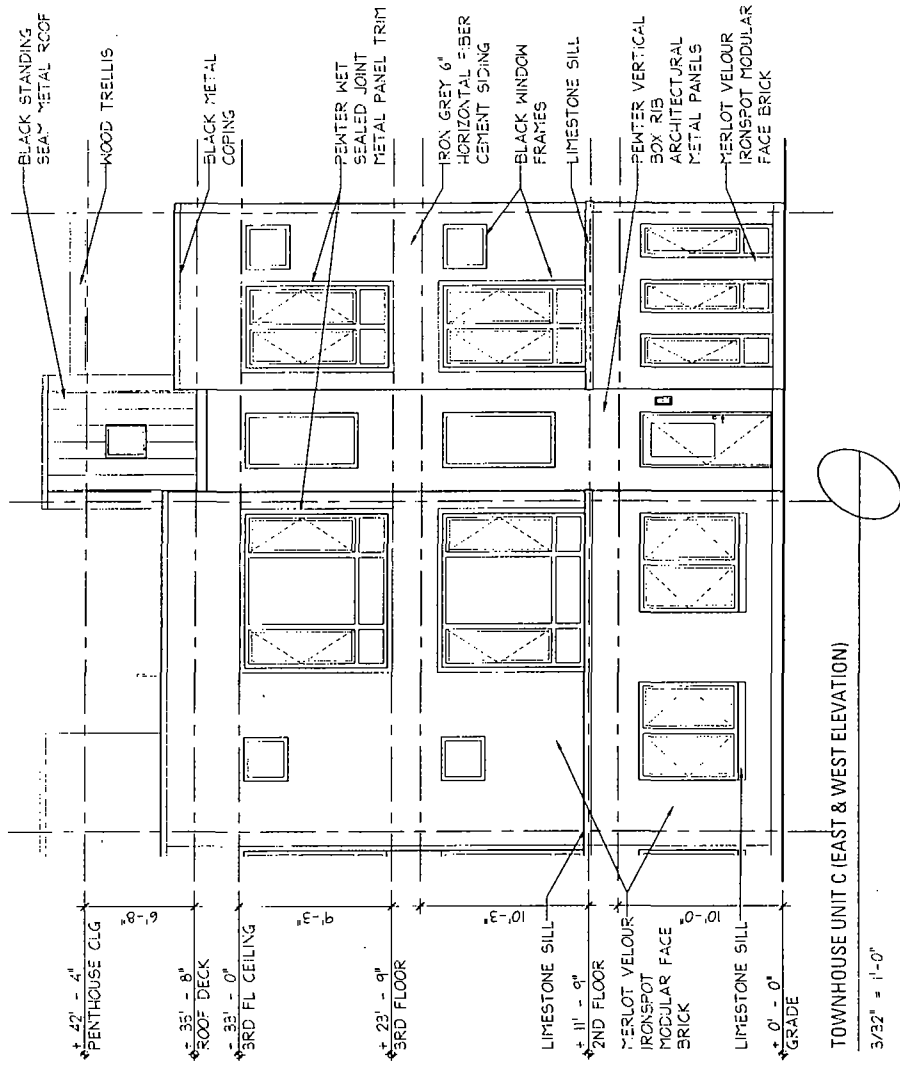

TOWNHOUSE UNIT C (EAST & WEST ELEVATION)

3/32" = 1'-0"

**jsa**  
jonathan SPLITT architects ltd  
4001 north ravenwood avenue  
suite 601  
chicago illinois 60613-2576  
773 883 1017 fax 773 883 3081

applicant	NOAH PROPERTIES, LLC
address	4200 W BELMONT AVE 3202 N WILDARE AVE 4157 W MELROSE ST CHICAGO IL 60641
intro date	02/19/2020
plan commission date	05/21/2020

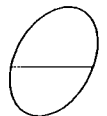

FINAL FOR PUBLICATION

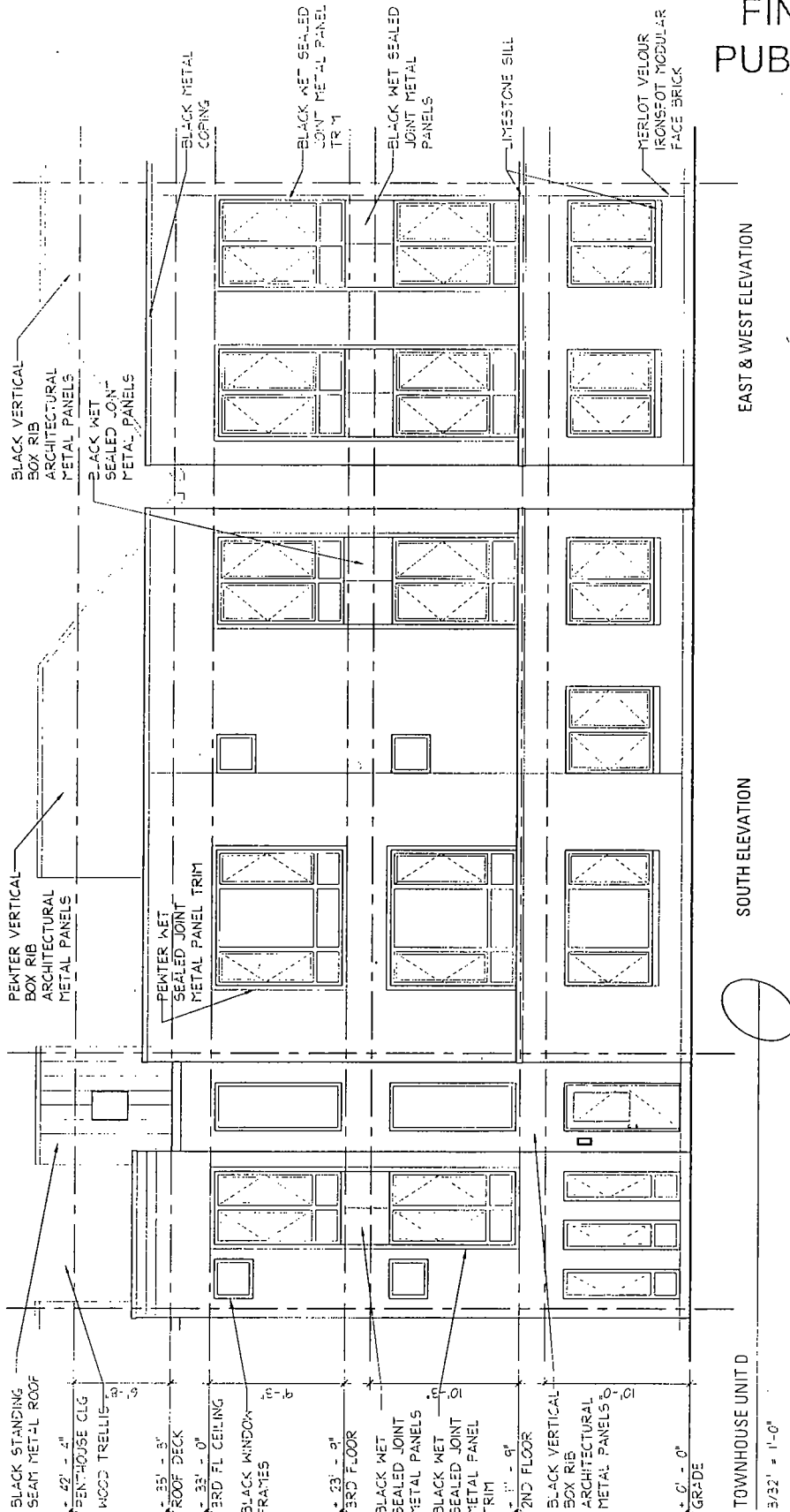

EAST & WEST ELEVATION

SOUTH ELEVATION

TOWNHOUSE UNIT D

3/32" = 1'-0"

jsa

Jonathan SPLITT architects Ltd.

4001 north ravenwood avenue  
 suite 501  
 ch.icago illinois 60613-2576  
 773 883 1017 fax 773 883 3081

applicant  
 address

NOAH PROPERTIES, LLC  
 4200 W BELMONT AVE  
 3202 N KILDARE AVE  
 4157 W MELROSE ST  
 CHICAGO IL 60641

intro date  
 plan commission date

02/19/2020  
 05/21/2020

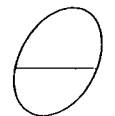

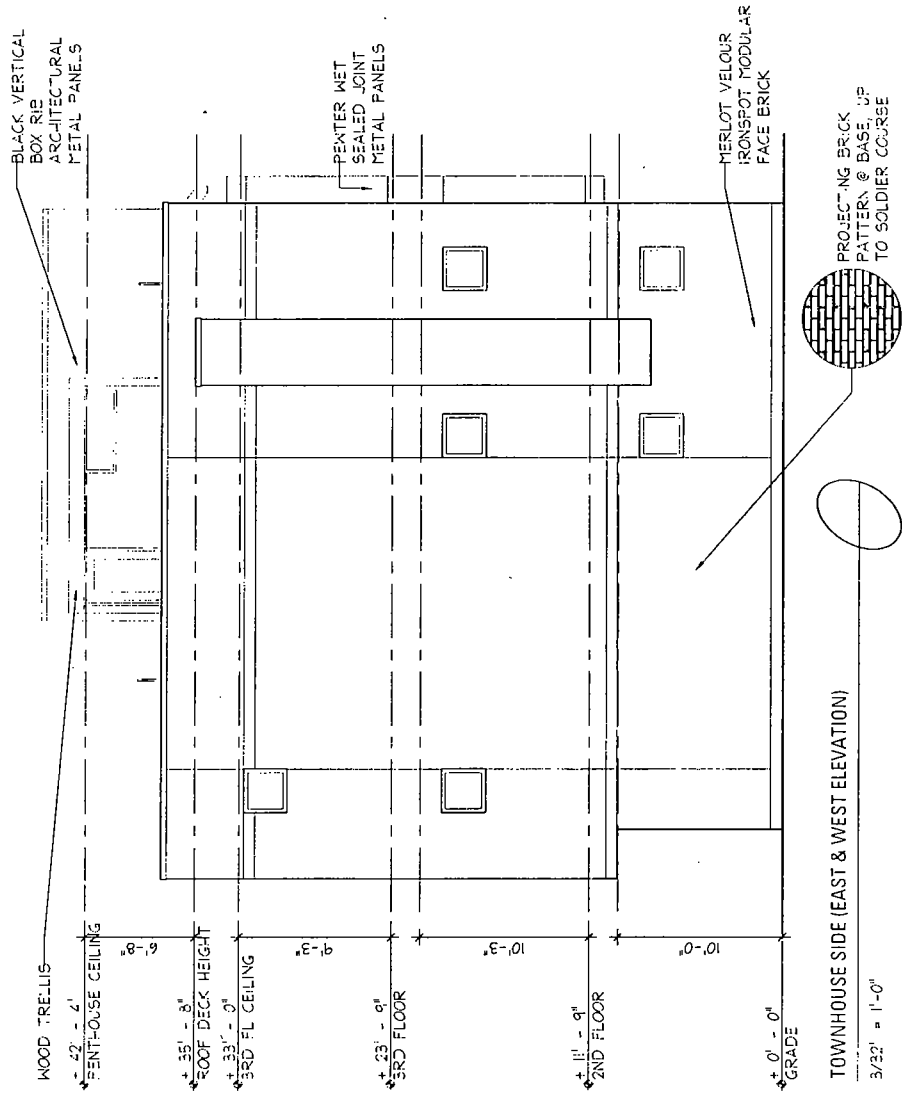

TOWNHOUSE SIDE (EAST & WEST ELEVATION)  
3/32" = 1'-0"

jSa

jonathan SPLITT architects ltd  
4001 north ravenwood avenue  
suite 601  
chicago illinois 60613-2576  
773 883 1017 fax 773 883 3081

applicant address

NOAH PROPERTIES, LLC  
4200 W BELMONT AVE  
3202 N KILDARE AVE  
4157 W MELROSE ST  
CHICAGO IL 60641

intro date 02/19/2020  
plan commission date 05/21/2020

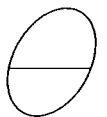

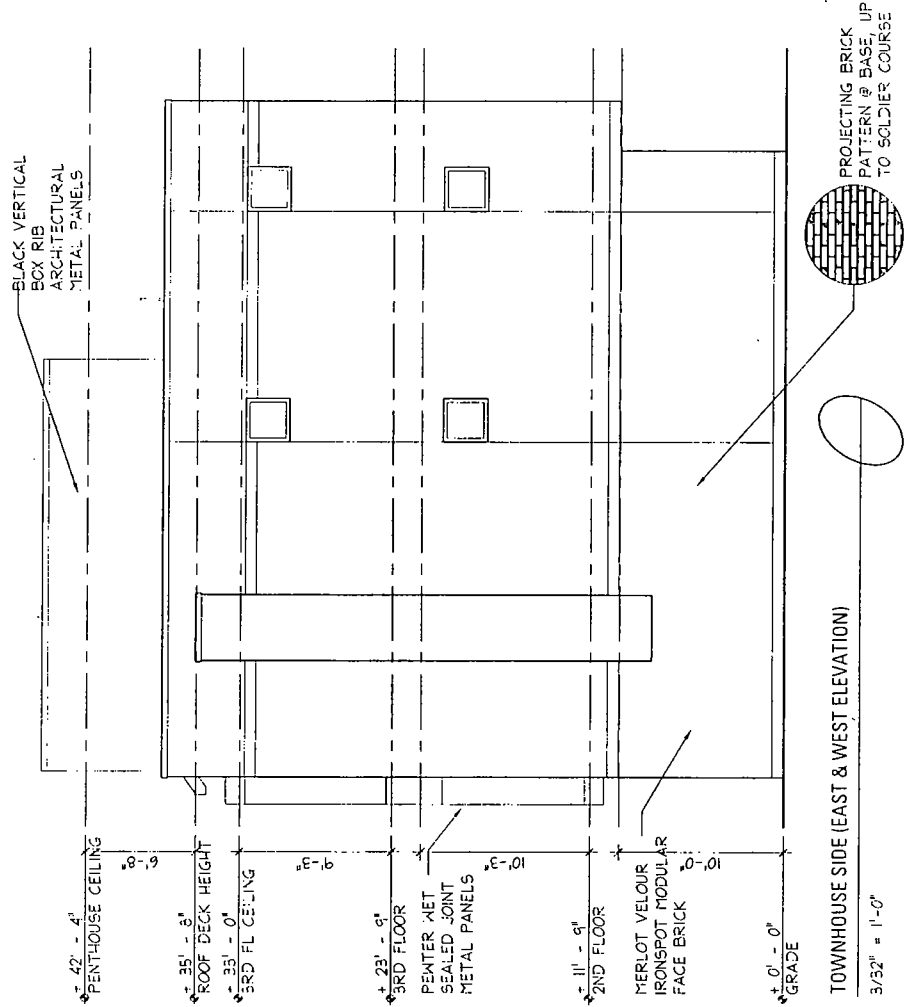

jSa

Jonathan SPLITT architects ltd  
4001 north ravenwood avenue  
suite 601  
chicago illinois 60613-2576  
773 883 1017 fax 773 883 3081

applicant  
address

NOAH PROPERTIES LLC  
4200 W BELMONT AVE  
3202 N KILDARE AVE  
4157 W MELROSE ST  
CHICAGO IL 60641

intro date

02/19/2020

plan commission date

05/21/2020

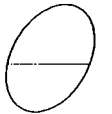



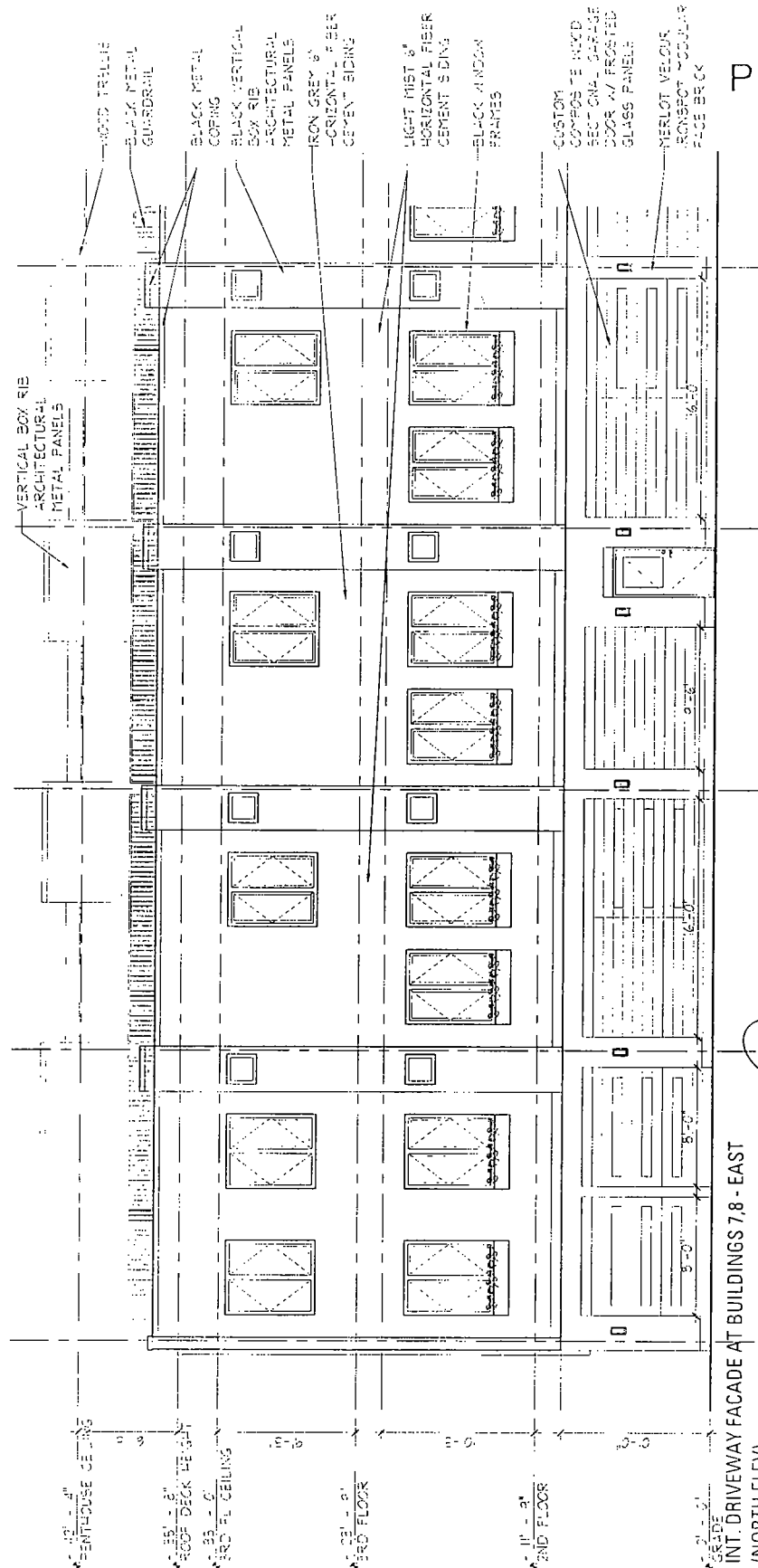

INT. DRIVEWAY FACADE AT BUILDINGS 7.8 - EAST  
(NORTH ELEV.)

1/2" = 1'-0"

**jsa**  
 jonathan SPLITT architects ltd  
 4001 north ravenwood avenue  
 suite 601  
 chicago illinois 60613-2576  
 773 883 1017 fax 773 883 3081

applicant address NOAH PROPERTIES, LLC  
 4200 W BELMONT AVE  
 3202 N KILDARE AVE  
 4157 W MELROSE ST  
 CHICAGO IL 60651  
 intro date 02/19/2020  
 plan commission date 05/21/2020

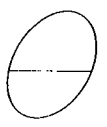

FINAL FOR PUBLICATION

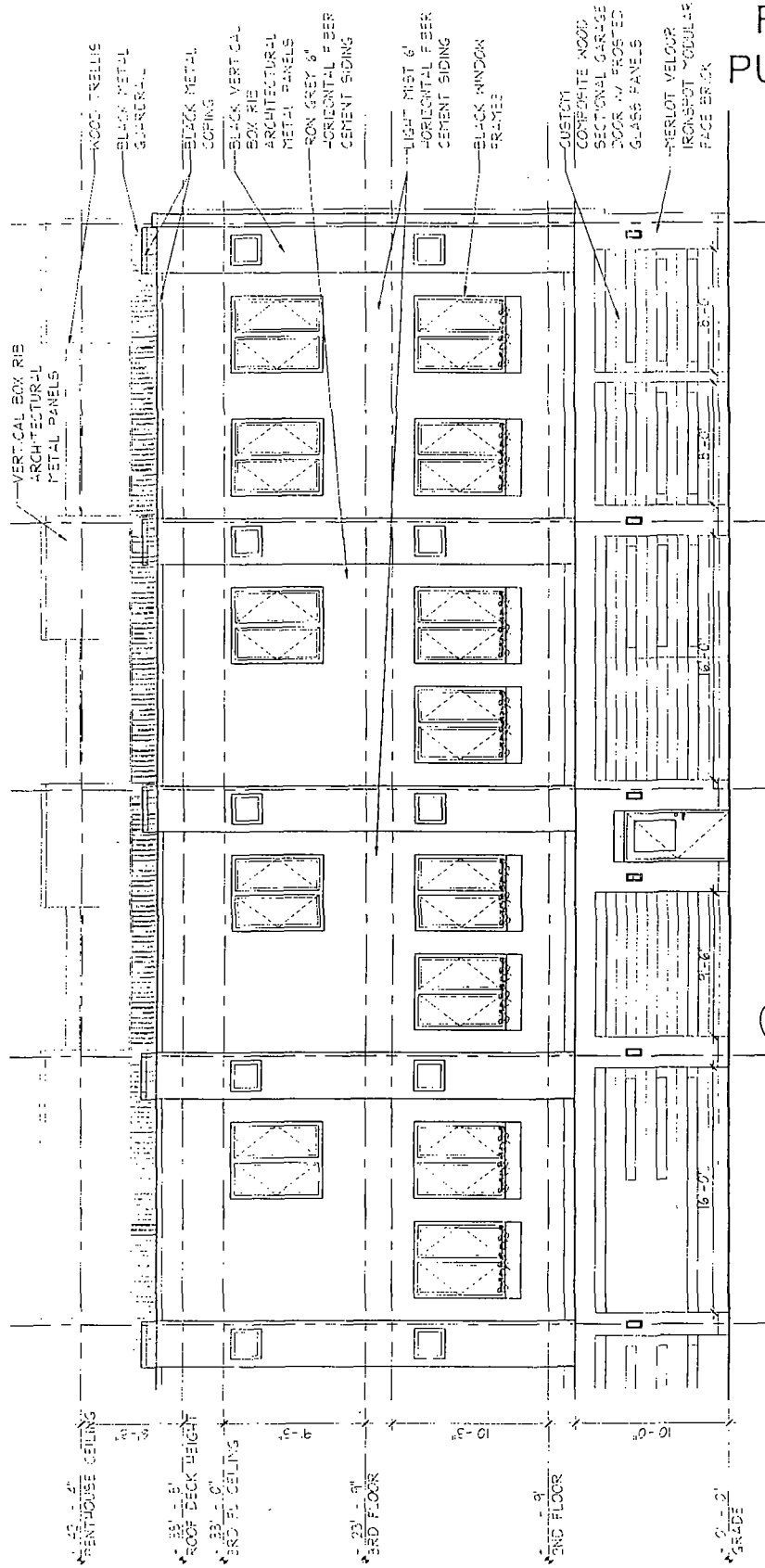

INT. DRIVEWAY FACADE AT BUILDINGS 7, 8 - WEST (NORTH ELEV)

1/8" = 1'-0"

**jsa**  
 Jonathan SPLITT architects Ltd.  
 400 North Ravenswood Avenue  
 Suite 601  
 Chicago Illinois 60613-2576  
 773 883 1017 fax 773 883 3081

applicant	NOAH PROPERTIES LLC
address	4200 W BELMONT AVE 3202 N KILDARE AVE 4157 W MELROSE ST CHICAGO IL 60651
intro date	02/19/2020
plan commission date	05/21/2020

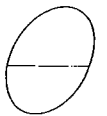

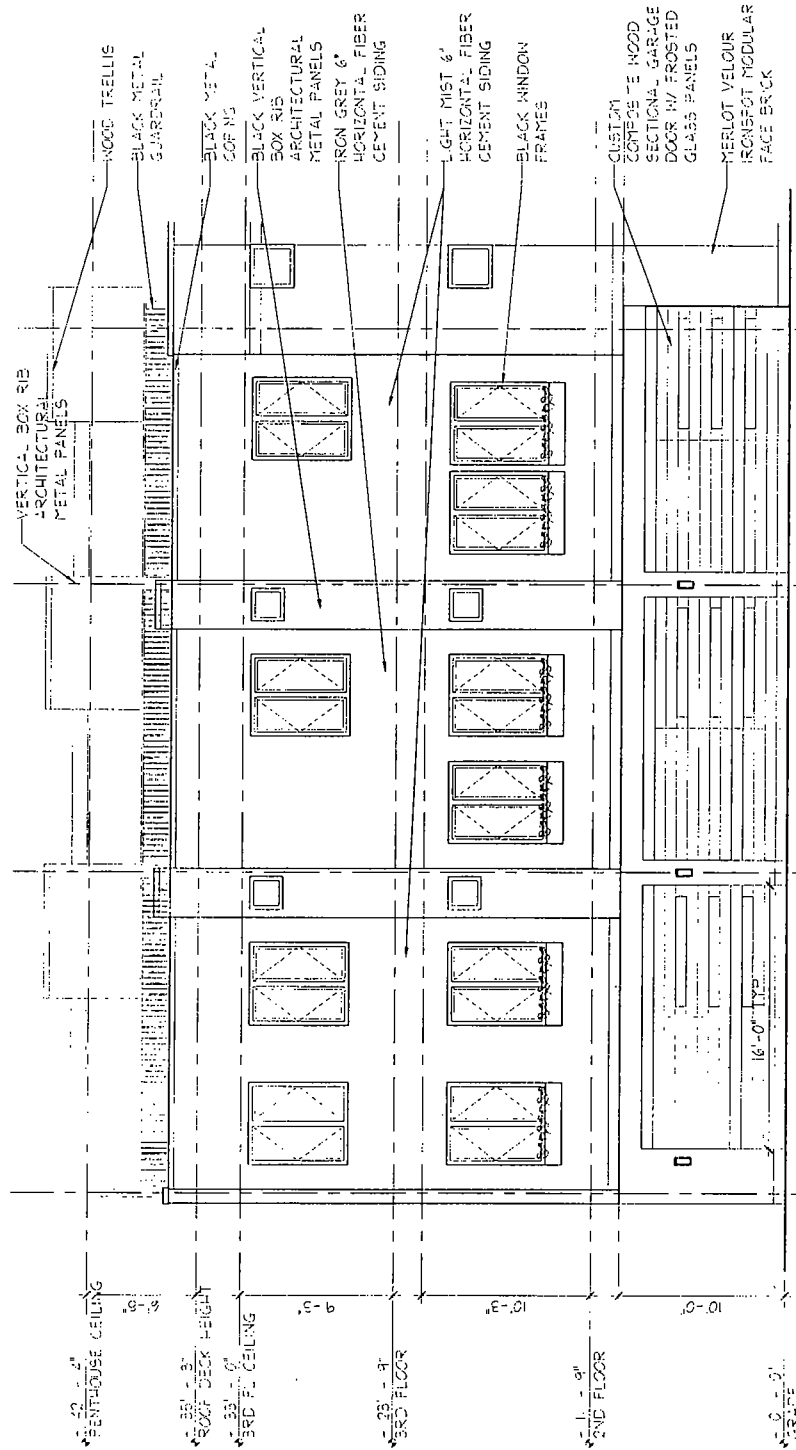

INTERIOR DRIVEWAY FACADE AT BUILDINGS 1, 6 (NORTH ELEV)  
 3/23' = 1'-0"

jsa  
 jonathan SPLITT architects ltd  
 4001 north ravenwood avenue  
 suite 601  
 chicago illinois 60613-2576  
 773 883 1017 fax 773 883 3081

applicant address NOAH PROPERTIES, LLC  
 4200 W BELMONT AVE  
 3202 N KILDAHE AVE  
 4157 W MELROSE ST  
 CHICAGO, IL 60641  
 intro date 02/19/2020  
 plan commission date 05/21/2020

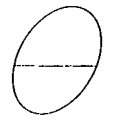

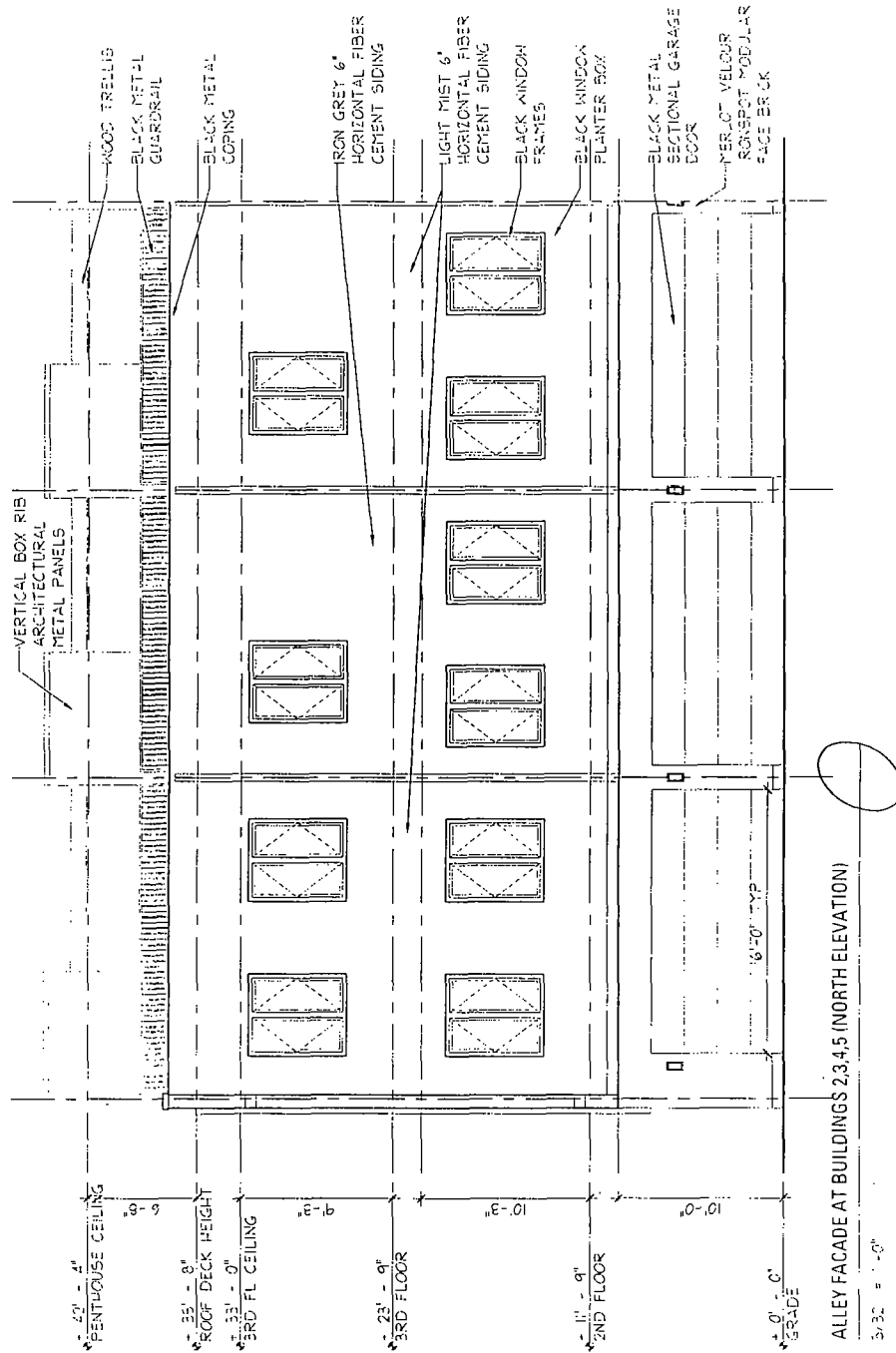

ALLEY FACADE AT BUILDINGS 2,3,4,5 (NORTH ELEVATION)

3'-32" = 1'-0"

**jsa**  
 jonathan SPLITT architects ltd  
 4001 north ravenwood avenue  
 suite 601  
 chicago illinois 60613-2576  
 773 883 1017 fax 773 883 3081

applicant	NOAH PROPERTIES LLC
address	4200 W BELMONT AVE 3202 N KILLBARE AVE 4157 W MELROSE ST CHICAGO IL 60621
intro date	02/19/2020
plan commission date	05/21/2020

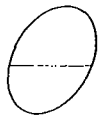

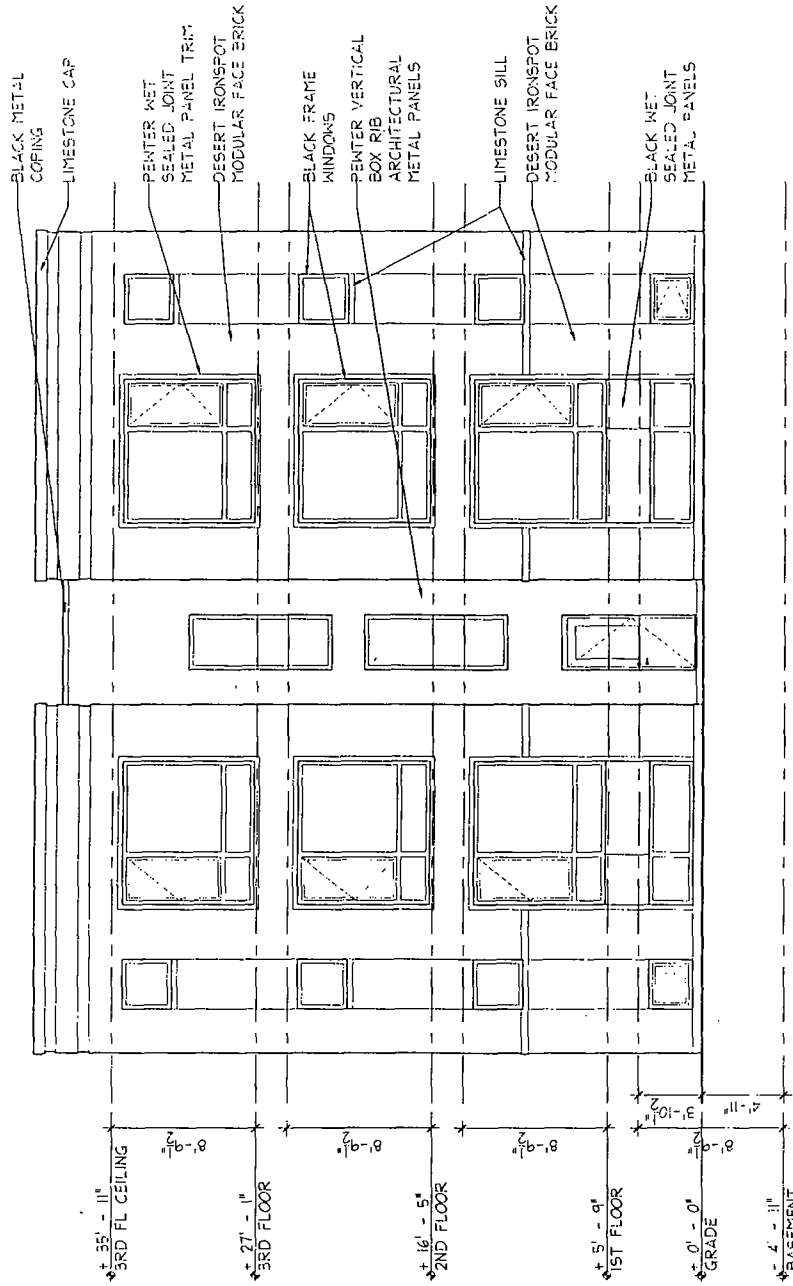

3202 N KILDARE EAST (FRONT)

3/32" = 1'-0"

**JSa**  
 jonathan SPLITT architects ltd  
 4001 north ravenswood avenue  
 suite 801  
 chicago illinois 60613-2576  
 773 883 1017 fax 773 883 3081

applicant	NOAH PROPERTIES LLC
address	4200 W BELMONT AVE 3202 N KILDARE AVE 4157 W MELROSE ST CHICAGO IL 60641
intro date	02/19/2020
plan commission date	05/21/2020

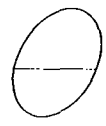

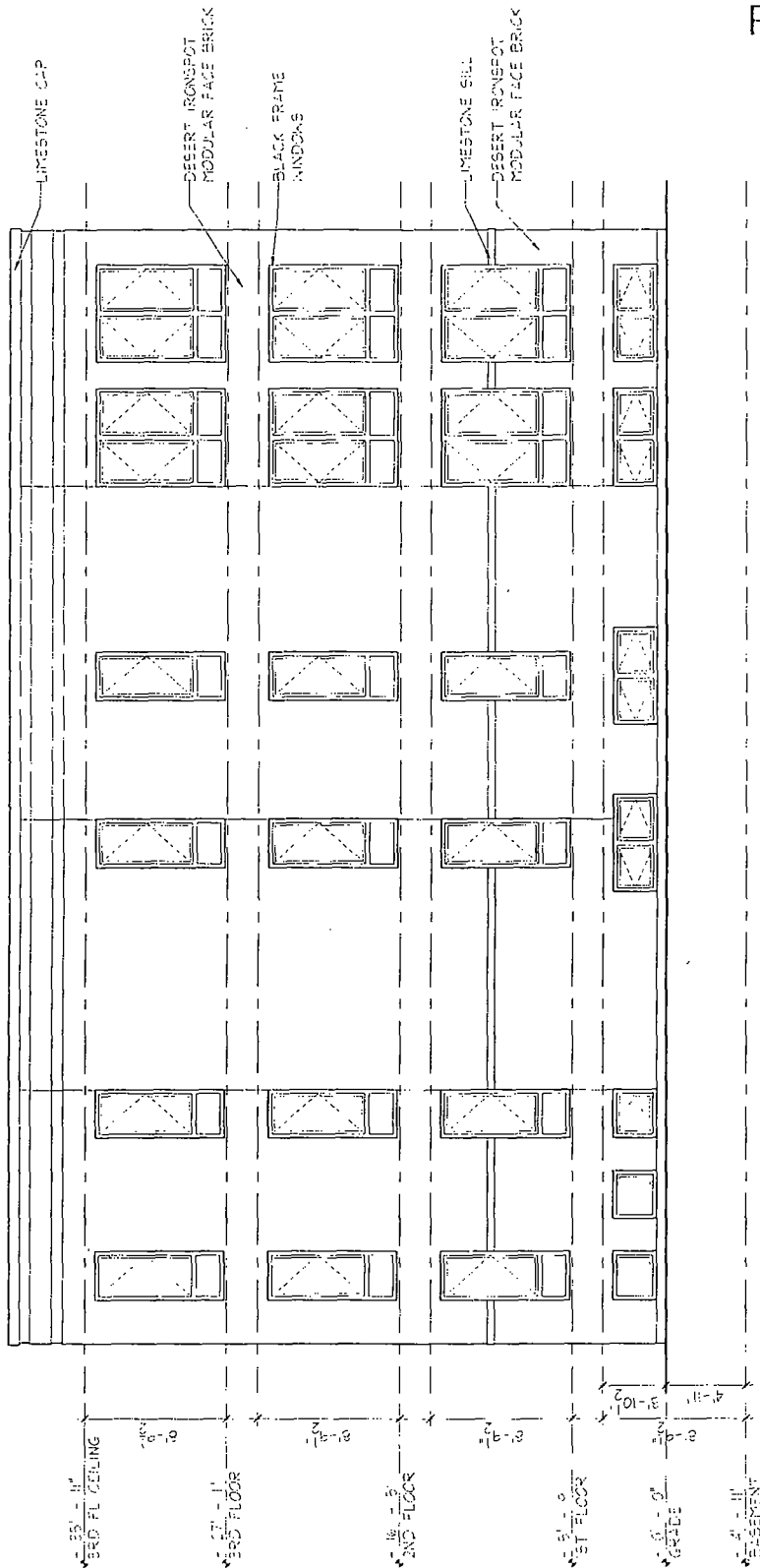

3202 N KILDARE NORTH  
1/2" = 1'-0"

**jSa**  
jonathan SPLITT architects ltd  
400 i north ravenswood avenue  
suite 60  
chicago illinois 60613-2575  
773 883 1017 fax 773 883 3081

applicant  
address

NOAH PROPERTIES LLC  
4200 W BELMONT AVE  
3202 N KILDARE AVE  
4157 W MELROSE ST  
CHICAGO IL 60641

intro date  
plan commission date

02/19/2020  
05/21/2020

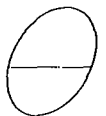

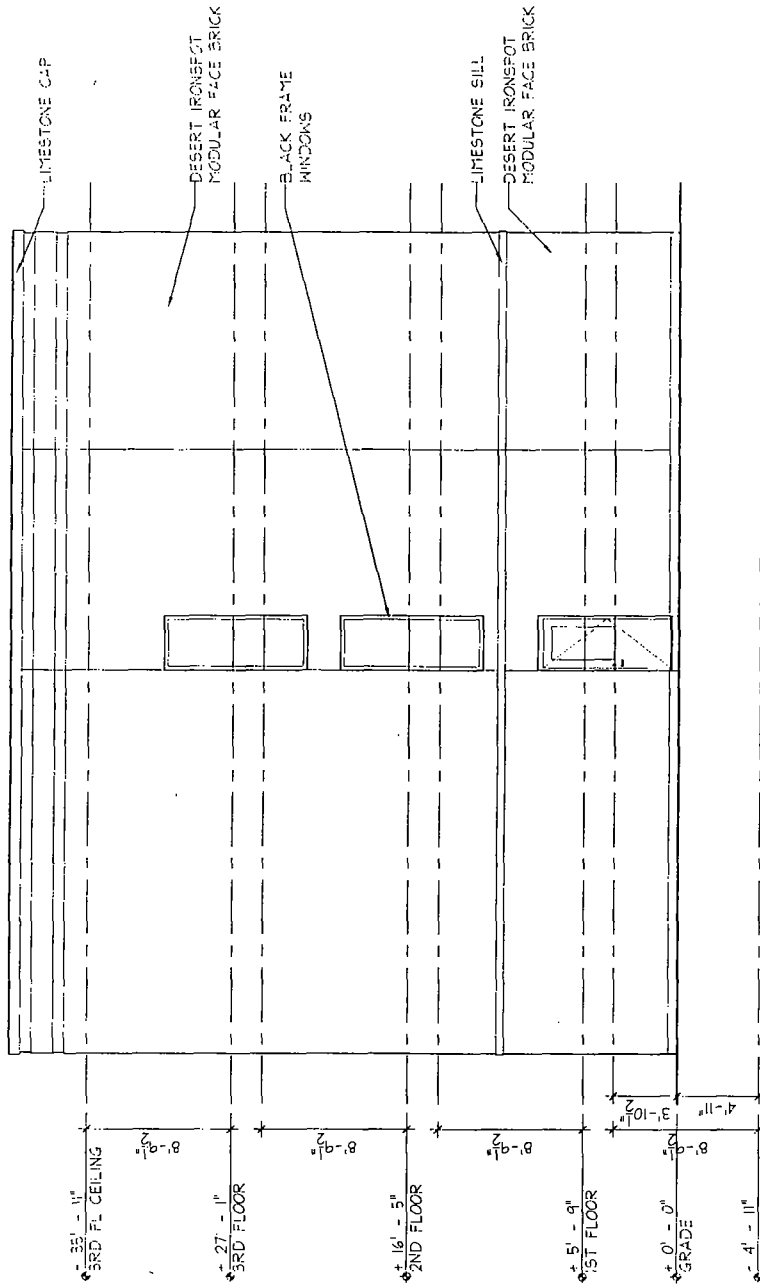

3202 N KILDARE WEST  
3/32" = 1'-0"

**jsa**  
Jonathan SPLITT architects ltd  
400' north ravenswood avenue  
suite 501  
chicago illinois 60613-2575  
773 883 1017 fax 773 883 3081

applicant address NOAH PROPERTIES, LLC  
4200 W BELMONT AVE  
3202 N KILDARE AVE  
4157 W MELROSE ST  
CHICAGO IL 60641  
intro date 02/19/2020  
plan commission date 05/21/2020

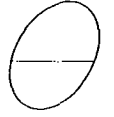

FINAL FOR PUBLICATION

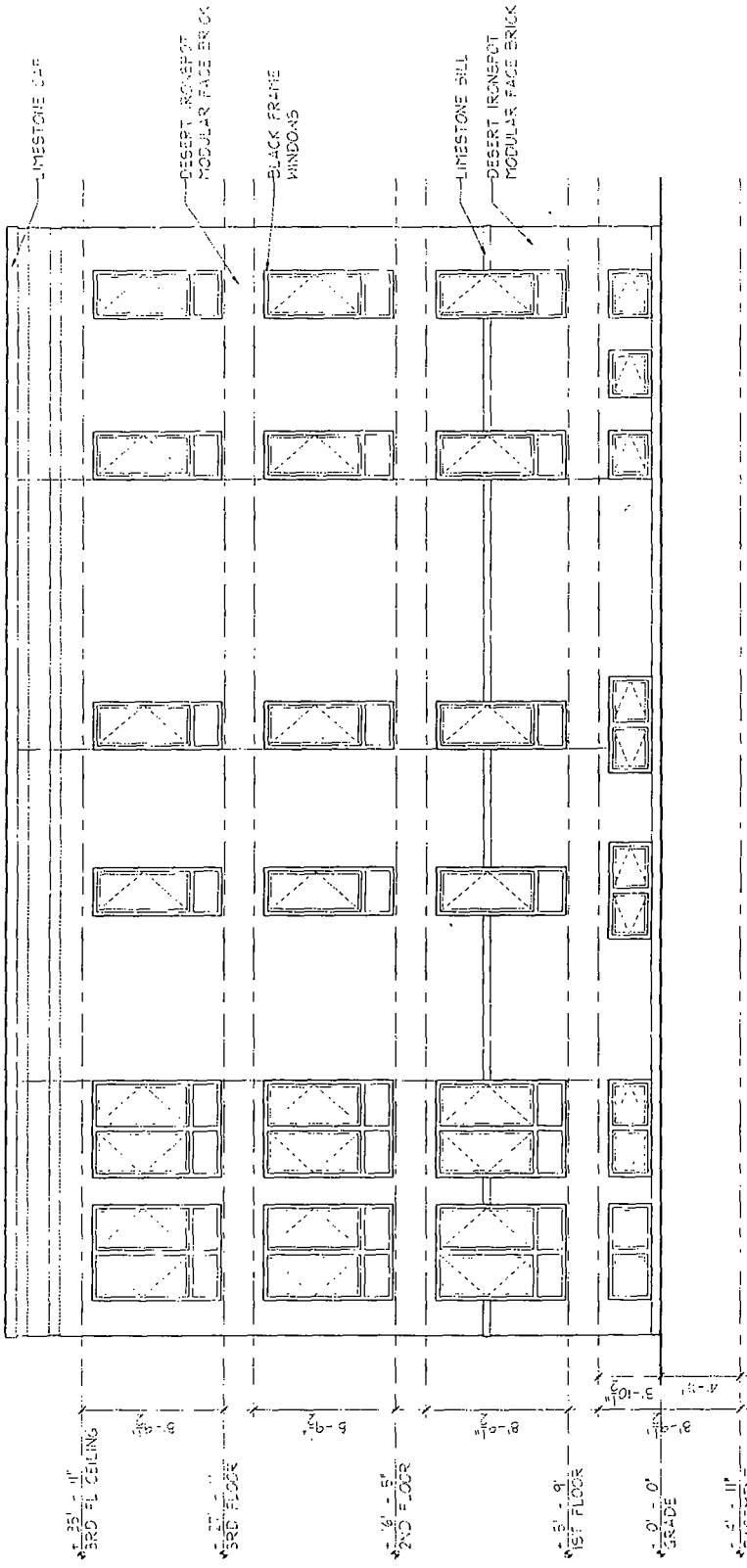

3202 N KILDARE SOUTH  
 2/52" = 1'-0"

**jSa**  
 jonathan SPLITT architects ltd  
 4001 north ravenwood avenue  
 suite 601  
 chicago illinois 60613-2576  
 773 883 1017 fax 773 883 3081

applicant address NOAH PROPERTIES LLC  
 4200 W BELMONT AVE  
 3202 N KILDARE AVE  
 4157 W MELROSE ST  
 CHICAGO, IL 60641  
 intro date 02/19/2020  
 plan commission date 05/21/2020

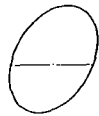



FINAL FOR PUBLICATION

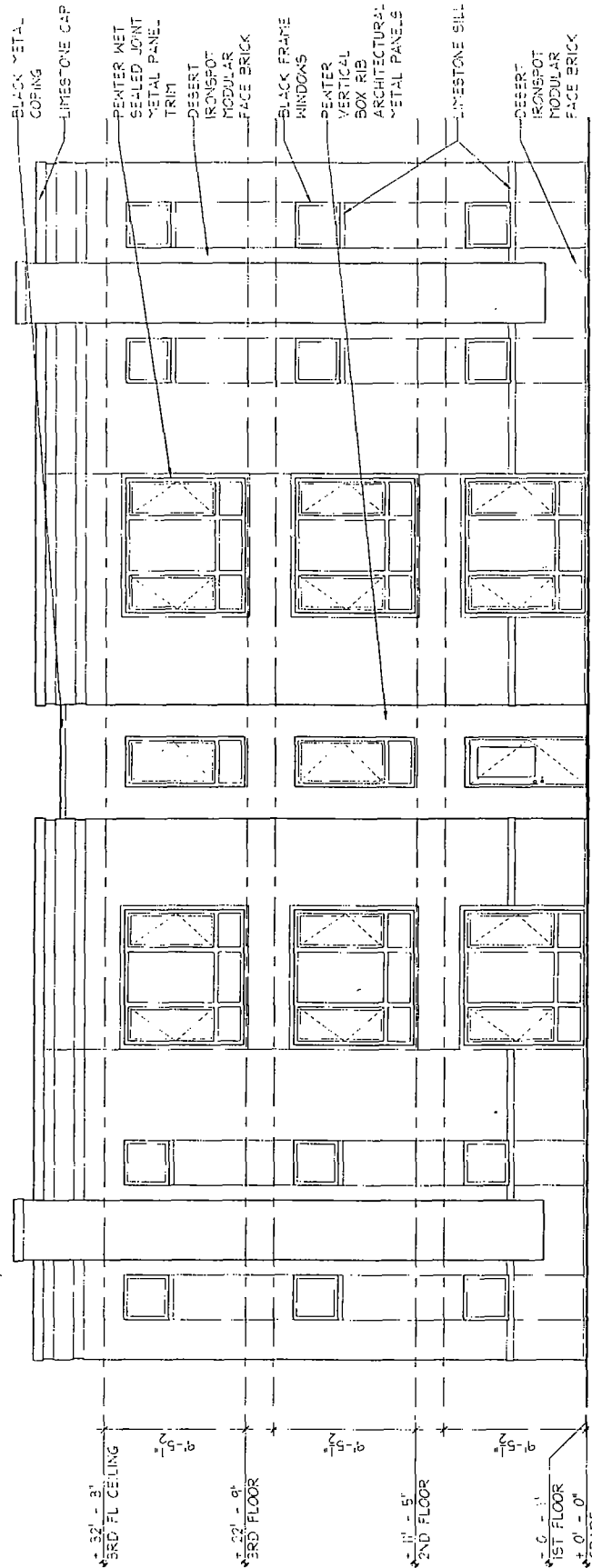

**jsa**  
 jonathan SPLITT architects ltd  
 4001 north ravenwood avenue  
 suite 601  
 chicago, Illinois 60613-2576  
 773 883 1017 fax 773 883 3081

applicant address  
 intro date  
 plan commission date

4155 W MELROSE NORTH (FRONT)

3/22' = 1'-0"

NOAH PROPERTIES, LLC  
 4200 W BELLAIR AVE  
 3202 N KILDARE AVE  
 4157 W MELROSE ST  
 CHICAGO IL 60641  
 02/19/2020  
 05/21/2020

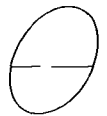

FINAL FOR PUBLICATION

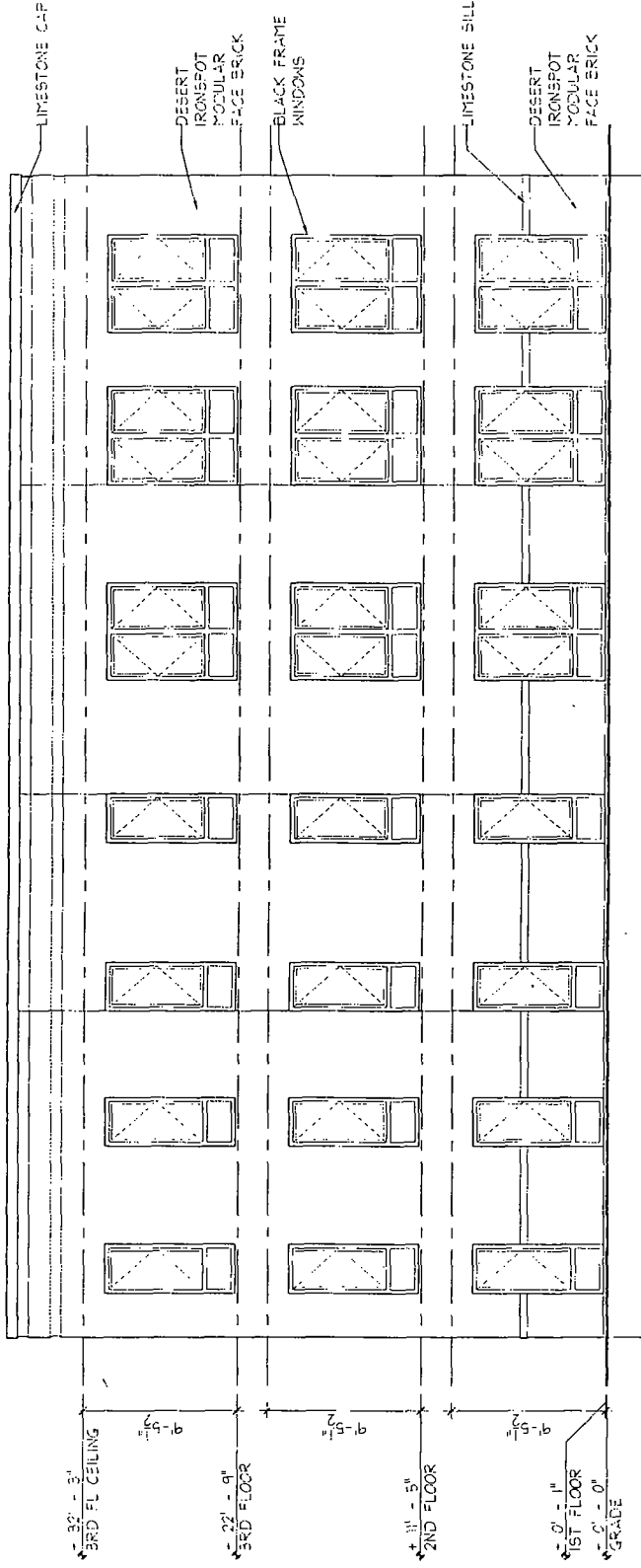

4155 W MELROSE WEST  
 3'-5" = 1'-0"

**jsa**  
 jonathan SPLITT architects ltd.  
 4001 north raverswood avenue  
 suite 601  
 chicago illinois 60613-2576  
 773 883 1017 fax 773 883 3081

applicant address NOAH PROPERTIES, LLC  
 4200 W BELMONT AVL  
 3202 N KILDARE AVE  
 4157 W MELROSE ST  
 CHICAGO IL 60641  
 intro date 02/19/2020  
 plan commission date 05/21/2020

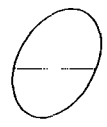

FINAL FOR PUBLICATION

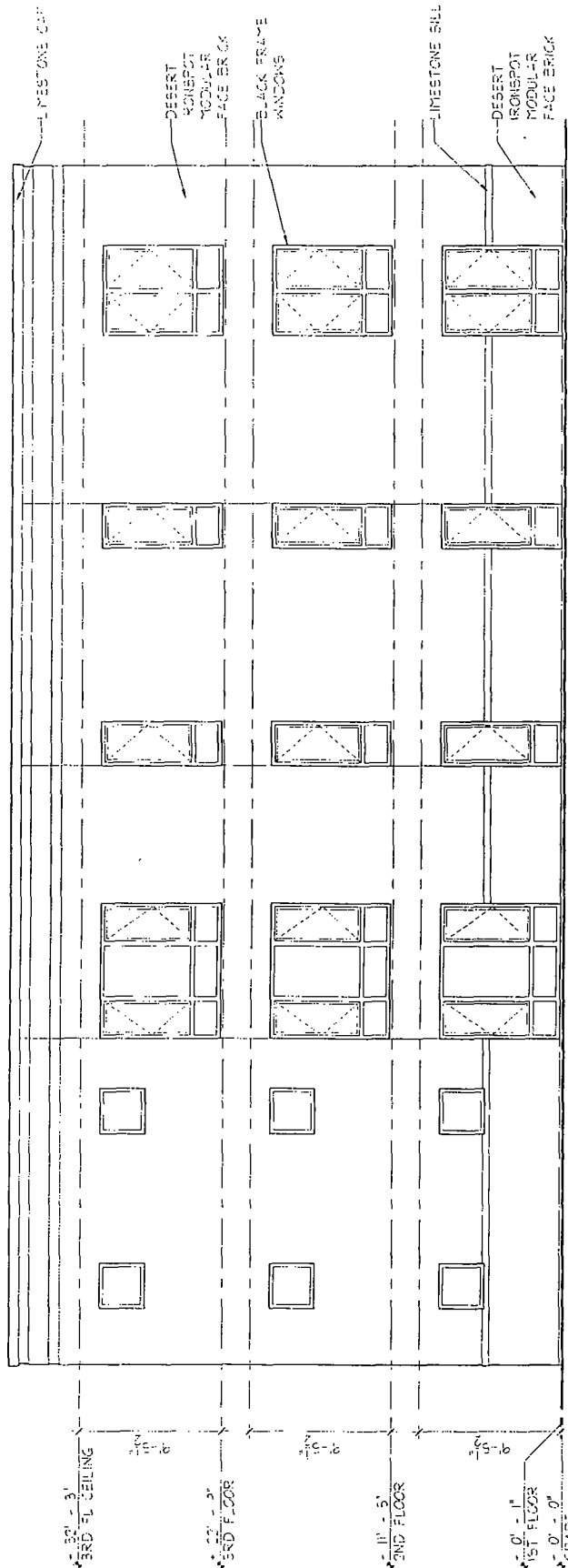

4155 W MELROSE SOUTH  
3/22" = 1'-0"

**jsa**  
 jonathan SPLITT architects ltd.  
 4001 north ravenwood avenue  
 suite 601  
 chicago illinois 60613-2576  
 773 883 1017 fax 773 883 3081

applicant  
 address

NOAH PROPERTIES LLC  
 4200 W BELMONT AVE  
 3202 N KILDARE AVE  
 4157 W MILLROSE ST  
 CHICAGO, IL 60641

intro date  
 plan commission date

02/19/2020  
 05/21/2020

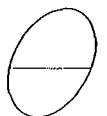

FINAL FOR PUBLICATION

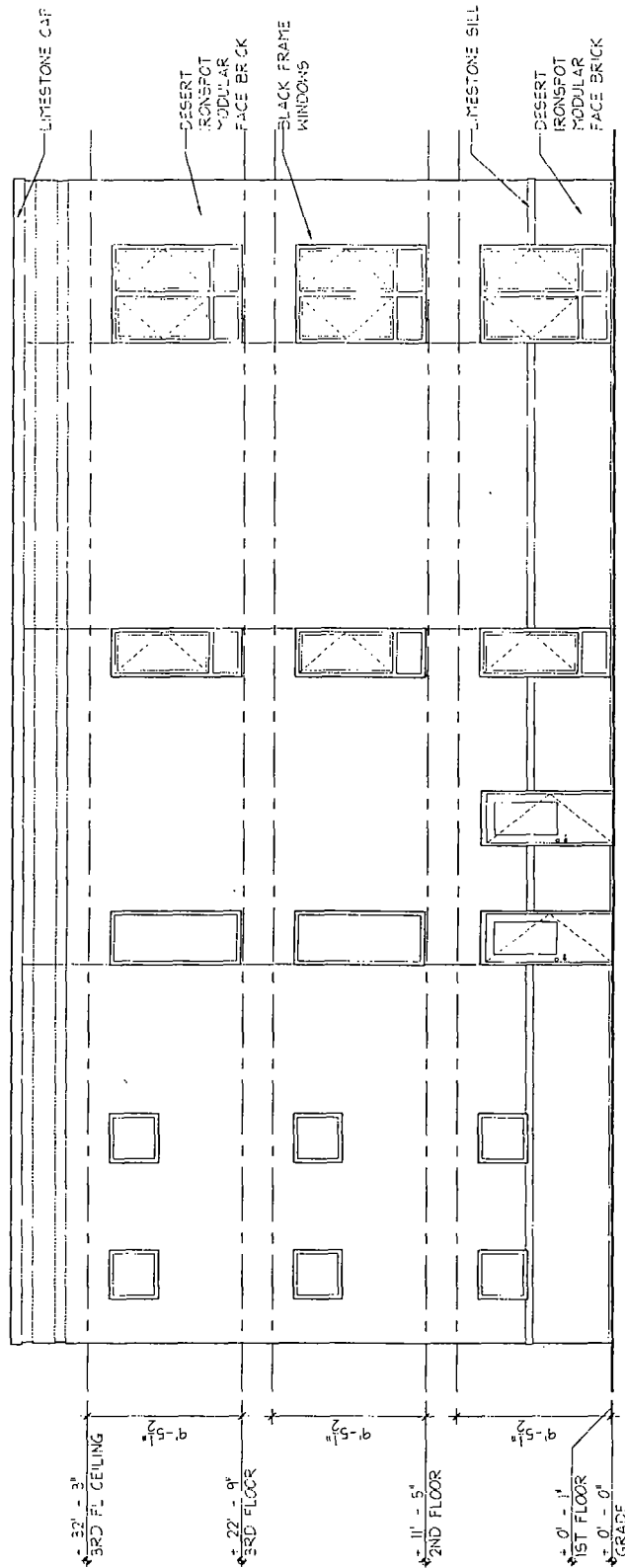

4155 W MELROSE EAST

3/22' = 1/8"

**jsa**  
 jonathan SPLITT architects ltd  
 4001 north ravenwood avenue  
 suite 601  
 chicago illinois 60613-2576  
 773 883 1017 fax 773 883 3081

applicant  
 address

NOAH PROPERTIES LLC  
 4200 W BELMONT AVE  
 3202 N KILDARE AVE  
 4157 W MELROSE ST  
 CHICAGO IL 60641

intro date  
 plan commission date

02/19/2020  
 05/12/2020

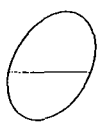



To: Clerk  
Application #: 20350

DEPARTMENT OF PLANNING AND DEVELOPMENT  
CITY OF CHICAGO

MEMORANDUM

To: Alderman Tom Tunney  
Chairman, City Council Committee on Zoning

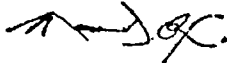
From:   
Maurice D. Cox  
Chicago Plan Commission

Date: May 21, 2020

Re: Proposed Amendment to Planned Development 409 (4200 W. Belmont)

---

On May 21, 2020, the Chicago Plan Commission recommended approval of the proposed amendment to Planned Development 409, submitted by Noah Properties, LLC. The applicant proposes to rezone the property to B2-2 (Neighborhood Mixed Use District) and establish Planned Development 409, as amended, to allow for the construction of 52 residential townhomes and 100 accessory parking spaces at 4200 West Belmont Avenue, 6 dwelling units in a multi-family building with 6 accessory parking spaces at 3202 North Kildare Avenue, and 9 dwelling units in a multi-family building with 9 accessory parking spaces at 4157 West Melrose Street. A copy of the proposed ordinance, planned development statements, bulk table and exhibits are attached. I would very much appreciate your assistance in having this introduced at the next possible City Council Committee on Zoning.

Also enclosed is a copy of the staff report to the Plan Commission which includes the Department of Planning and Development, Bureau of Zoning recommendation and a copy of the resolution. If you have any questions in this regard, please do not hesitate to contact Emily Thrun at 312-744-0756.

Cc: PD Master File (Original PD, copy of memo)