



Office of the City Clerk



O2012-8197

Office of the City Clerk

City Council Document Tracking Sheet

Meeting Date:	12/12/2012
Sponsor(s):	Mendoza, Susana A. (Clerk)
Type:	Ordinance
Title:	Zoning Reclassification App No. 17633 at 2232 N Clybourn Ave
Committee(s) Assignment:	Committee on Zoning, Landmarks and Building Standards

ORDINANCE

BE IT ORDAINED BY THE CITY COUNCIL OF THE CITY OF CHICAGO:

SECTION 1. Title 17 of the Municipal Code of Chicago, the Chicago Zoning Ordinance, is hereby amended by changing all of the M1-2 Manufacturing- Business Park District symbols and indications as shown on Map No. 5-G in the area bounded by

North Clybourn; a line 353.70 feet northwest of West Webster Avenue running for a distance of 120.00 feet; a line 120.00 feet southwest of and parallel to North Clybourn Avenue running for a distance of 35.00 feet; a line 388.70 feet northwest of West Webster Avenue running for a distance of 120.00 feet

to those of a C3-2 Commercial Manufacturing and Employment District.

SECTION 2. This ordinance takes effect after its passage and approval.

Common Address of Property: 2232 North Clybourn

CITY OF CHICAGO
APPLICATION FOR AN AMENDMENT TO
THE CHICAGO ZONING ORDINANCE

#17633

INTRO DATE:

12-12-12

1. ADDRESS of the property Applicant is seeking to rezone:

2232 North Clybourn

2. Ward Number that property is located in: 32

3. APPLICANT Drona Group, LLC

ADDRESS 1605 Half Day Road

CITY Bannockburn STATE IL ZIP CODE 60015

PHONE _____ CONTACT PERSON Vimal Bahuguna

4. Is the applicant the owner of the property? YES NO _____

If the applicant is not the owner of the property, please provide the following information regarding the owner and attach written authorization from the owner allowing the application to proceed.

OWNER Same as Applicant

ADDRESS _____

CITY _____ STATE _____ ZIP CODE _____

PHONE _____ CONTACT PERSON _____

5. If the Applicant/Owner of the property has obtained a lawyer as their representative for the rezoning, please provide the following information:

ATTORNEY Bernard I. Citron, Thompson Coburn, LLP

ADDRESS 55 East Monroe, 37th Floor CITY Chicago

PHONE 312-346-7500 FAX _____

6. If the applicant is a corporation please provide the names of all shareholders as disclosed on the Economic Disclosure Statements.

Vimal Bahuguna, Bulbul Bahuguna

7. On what date did the owner acquire legal title to the subject property? 2006

8. Has the present owner previously rezoned this property? If yes, when?
No

9. Present Zoning District M1-2 Proposed Zoning District C3-2

10. Lot size in square feet (or dimensions) 4,200 square feet

11. Current Use of the property vacant and office

12. Reason for rezoning the property To allow retail and office uses

13. Describe the proposed use of the property after the rezoning. Indicate the number of dwelling units; number of parking spaces; approximate square footage of any commercial space; and height of the proposed building. (BE SPECIFIC)

The approximately 15,000 square foot building will be leased to retail uses on ground floor and
Office uses above

14. On May 10, 2007, the Chicago City Council passed the Affordable Requirements Ordinance (ARO) that requires on-site affordable housing units or a financial contribution if residential housing projects receive a zoning change under certain circumstances. Based on the lot size of the project in question and the proposed zoning classification, is this project subject to the Affordable Requirements Ordinance? (See Fact Sheet for more information)

YES _____ NO X

COUNTY OF COOK
STATE OF ILLINOIS

V Bahuguna, being first duly sworn on oath, states that all of the above statements and the statements contained in the documents submitted herewith are true and correct.

Bahuguna
Signature of Applicant

Subscribed and Sworn to before me this
16th day of November, 2012.

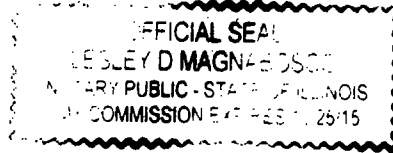

Wesley D. Magnalosa
Notary Public

For Office Use Only

Date of Introduction: _____

File Number: _____

Ward: _____

LIBRARY
OF THE
JAMES EARL RAY
FOUNDATION

"WRITTEN NOTICE"
FORM OF AFFIDAVIT
(Section 17-13-0107)

December 12, 2012

Honorable Daniel S. Solis
Chairman, Committee on Zoning
121 North LaSalle Street
Room 304, City Hall
Chicago, Illinois 60602

The undersigned, Bernard I. Citron, being first duly sworn on oath deposes and states the following:

The undersigned certifies that he has complied with the requirements of Section 17-13-0107 of the Chicago Zoning Ordinance, by sending written notice to such property owners who appear to be the owners of the property within the subject area not solely owned by the applicant, and to the owners of all property within 250 feet in each direction of the lot line of the subject property, exclusive of public roads, streets, alleys and other public ways, or a total distance limited to 400 feet. Said "written notice" was sent by First Class U.S. Mail, no more than 30 days before filing the application.

The undersigned certifies that the notice contained the address of the property sought to be rezoned; a statement of the intended use of the property; the name and address of the applicant; the name and address of the owner; and a statement that the applicant intends to file the application for a change in zoning on approximately December 12, 2012.

The undersigned certifies that the applicant has made a bona fide effort to determine the addresses of the parties to be notified under Section 17-13-0107 of the Chicago Zoning Ordinance, and that the accompanying list of names and addresses of surrounding property owners within 250 feet of the subject site is a complete list containing the names and addresses of the people required to be served.

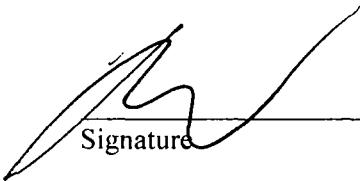

Signature

Subscribed and Sworn to before me this
12th day of December, 2012



Notary Public

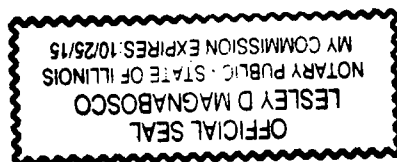

RECEIVED
JAN 19 1964
U.S. AIR FORCE
HEADQUARTERS
WASHINGTON, D.C.

December 12, 2012

Dear Property Owner:

In accordance with the requirements for an Amendment to the Chicago Zoning Ordinance, specifically Section 17-13-0107, please be informed that on or about December 12, 2012, the undersigned will file an application for a change in zoning from M1-2 District to C3-2 District on behalf of Drona Group, LLC for the property located at 2232 North Clybourn.

The applicant intends to use the existing building for retail uses on ground floor and office uses above in an approximately 15,000 square foot building.

The applicant and owner of the property is Drona Group, LLC is located at 1605 Half Day Road, Bannockburn, IL 60015. The contact person for this application is Bernard I. Citron, Thompson Coburn, LLP, 55 East Monroe, 37th Floor, Chicago, Illinois 60603, 312-346-7500.

Please note that the applicant is not seeking to rezone or purchase your property. The applicant is required by law to send this notice because you own property within 250 feet of the property to be rezoned.

Sincerely,

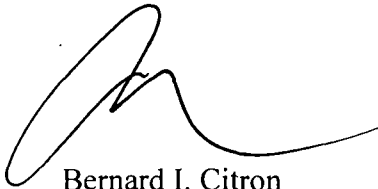
A handwritten signature in black ink, appearing to read "Bernard I. Citron". The signature is fluid and cursive, with a large initial "B" and "C".

Bernard I. Citron

Attorney for Applicant and Owner

**COMMERCIAL DEVELOPMENT
2232 N. Clybourn
REZONING TYPE 1 NARRATIVE
ZONING AND DEVELOPMENT ANALYSIS**

Lot Area:	4200 square feet
Maximum Floor Area:	2.0
Existing Floor Area (gross): (no change)	15150 s.f.
Existing Floor Area (net): (no change)	11,288 s.f.
Maximum Number of Residential Units:	0 units
Number of On-Site Accessory Parking Spaces:	5 spaces
Loading Spaces (no change):	0 spaces
Existing Building Height (no change):	48 feet
Existing Setbacks (no change):	North-East (Clybourn, front): 0 feet East (side): 0 feet West (side): 0 feet South-West (alley): 0 feet

PROJECT NARRATIVE: The approximately 15,000 square foot existing building will be leased to retail uses on the ground floor and office uses above. The building is currently vacant and not viable as a manufacturing building. The rezoning will allow the building to thrive as a retail and office building. Parking is provided. No physical changes to the building are proposed.

Commonly Known as: 2232 N. Clybourn, Chicago, Illinois

**CITY OF CHICAGO
ECONOMIC DISCLOSURE STATEMENT
AND AFFIDAVIT**

SECTION I -- GENERAL INFORMATION

A. Legal name of the Disclosing Party submitting this EDS. Include d/b/a/ if applicable:

Drona Group, LLC

Check ONE of the following three boxes:

Indicate whether the Disclosing Party submitting this EDS is:

1. the Applicant

OR

2. a legal entity holding a direct or indirect interest in the Applicant. State the legal name of the Applicant in which the Disclosing Party holds an interest: _____

OR

3. a legal entity with a right of control (see Section II.B.1.) State the legal name of the entity in which the Disclosing Party holds a right of control: _____

B. Business address of the Disclosing Party: 1605 Half Day Road

Bannockburn, IL 60015

C. Telephone: _____ Fax: _____ Email: _____

D. Name of contact person: Vimal Bahuguna

E. Federal Employer Identification No. (if you have one): _____

F. Brief description of contract, transaction or other undertaking (referred to below as the "Matter") to which this EDS pertains. (Include project number and location of property, if applicable):

Zoning Amendment at 2232 N. Clyborn

G. Which City agency or department is requesting this EDS? City of Chicago Department of Housing and Economic Development

If the Matter is a contract being handled by the City's Department of Procurement Services, please complete the following:

Specification # _____ and Contract # _____

SECTION II -- DISCLOSURE OF OWNERSHIP INTERESTS

A. NATURE OF THE DISCLOSING PARTY

1. Indicate the nature of the Disclosing Party:

- Person
- Publicly registered business corporation
- Privately held business corporation
- Sole proprietorship
- General partnership
- Limited partnership
- Trust
- Limited liability company
- Limited liability partnership
- Joint venture
- Not-for-profit corporation
- (Is the not-for-profit corporation also a 501(c)(3))?
- Yes
- No
- Other (please specify)

2. For legal entities, the state (or foreign country) of incorporation or organization, if applicable:

Illinois

3. For legal entities not organized in the State of Illinois: Has the organization registered to do business in the State of Illinois as a foreign entity?

- Yes
- No
- N/A

B. IF THE DISCLOSING PARTY IS A LEGAL ENTITY:

1. List below the full names and titles of all executive officers and all directors of the entity.

NOTE: For not-for-profit corporations, also list below all members, if any, which are legal entities. If there are no such members, write "no members." For trusts, estates or other similar entities, list below the legal titleholder(s).

If the entity is a general partnership, limited partnership, limited liability company, limited liability partnership or joint venture, list below the name and title of each general partner, managing member, manager or any other person or entity that controls the day-to-day management of the Disclosing Party.

NOTE: Each legal entity listed below must submit an EDS on its own behalf.

Name

Title

N/A

2. Please provide the following information concerning each person or entity having a direct or indirect beneficial interest (including ownership) in excess of 7.5% of the Disclosing Party. Examples of such an interest include shares in a corporation, partnership interest in a partnership or joint venture,

interest of a member or manager in a limited liability company, or interest of a beneficiary of a trust, estate or other similar entity. If none, state "None." **NOTE:** Pursuant to Section 2-154-030 of the Municipal Code of Chicago ("Municipal Code"), the City may require any such additional information from any applicant which is reasonably intended to achieve full disclosure.

Name	Business Address	Percentage Interest in the Disclosing Party
Vimal Bahuguna	1605 Half Day Road	50%
Bulbul Bahuguna	Bannockburn, IL 60015	50%

SECTION III -- BUSINESS RELATIONSHIPS WITH CITY ELECTED OFFICIALS

Has the Disclosing Party had a "business relationship," as defined in Chapter 2-156 of the Municipal Code, with any City elected official in the 12 months before the date this EDS is signed?

Yes No

If yes, please identify below the name(s) of such City elected official(s) and describe such relationship(s):

N/A

SECTION IV -- DISCLOSURE OF SUBCONTRACTORS AND OTHER RETAINED PARTIES

The Disclosing Party must disclose the name and business address of each subcontractor, attorney, lobbyist, accountant, consultant and any other person or entity whom the Disclosing Party has retained or expects to retain in connection with the Matter, as well as the nature of the relationship, and the total amount of the fees paid or estimated to be paid. The Disclosing Party is not required to disclose employees who are paid solely through the Disclosing Party's regular payroll.

“Lobbyist” means any person or entity who undertakes to influence any legislative or administrative action on behalf of any person or entity other than: (1) a not-for-profit entity, on an unpaid basis, or (2) himself. “Lobbyist” also means any person or entity any part of whose duties as an employee of another includes undertaking to influence any legislative or administrative action.

If the Disclosing Party is uncertain whether a disclosure is required under this Section, the Disclosing Party must either ask the City whether disclosure is required or make the disclosure.

Name (indicate whether retained or anticipated to be retained)	Business Address	Relationship to Disclosing Party (subcontractor, attorney, lobbyist, etc.)	Fees (indicate whether paid or estimated.) NOTE: "hourly rate" or "t.b.d." is not an acceptable response.
Bernard I. Citron	Thompson Coburn LLP 55 E. Monroe St., 37th Floor Chicago IL 60603	Attorney	Est. 12,000

(Add sheets if necessary)

Check here if the Disclosing Party has not retained, nor expects to retain, any such persons or entities.

SECTION V -- CERTIFICATIONS

A. COURT-ORDERED CHILD SUPPORT COMPLIANCE

Under Municipal Code Section 2-92-415, substantial owners of business entities that contract with the City must remain in compliance with their child support obligations throughout the contract's term.

Has any person who directly or indirectly owns 10% or more of the Disclosing Party been declared in arrears on any child support obligations by any Illinois court of competent jurisdiction?

Yes No No person directly or indirectly owns 10% or more of the Disclosing Party.

If "Yes," has the person entered into a court-approved agreement for payment of all support owed and is the person in compliance with that agreement?

Yes No

B. FURTHER CERTIFICATIONS

1. Pursuant to Municipal Code Chapter 1-23, Article I ("Article I")(which the Applicant should consult for defined terms (e.g., "doing business") and legal requirements), if the Disclosing Party submitting this EDS is the Applicant and is doing business with the City, then the Disclosing Party certifies as follows: (i) neither the Applicant nor any controlling person is currently indicted or charged with, or has admitted guilt of, or has ever been convicted of, or placed under supervision for, any criminal offense involving actual, attempted, or conspiracy to commit bribery, theft, fraud, forgery, perjury, dishonesty or deceit against an officer or employee of the City or any sister agency; and (ii) the Applicant understands and acknowledges that compliance with Article I is a continuing requirement for doing business with the City. NOTE: If Article I applies to the Applicant, the permanent compliance timeframe in Article I supersedes some five-year compliance timeframes in certifications 2 and 3 below.

2. The Disclosing Party and, if the Disclosing Party is a legal entity, all of those persons or entities identified in Section II.B.1. of this EDS:

- a. are not presently debarred, suspended, proposed for debarment, declared ineligible or voluntarily excluded from any transactions by any federal, state or local unit of government;
- b. have not, within a five-year period preceding the date of this EDS, been convicted of a criminal offense, adjudged guilty, or had a civil judgment rendered against them in connection with: obtaining, attempting to obtain, or performing a public (federal, state or local) transaction or contract under a public transaction; a violation of federal or state antitrust statutes; fraud; embezzlement; theft; forgery; bribery; falsification or destruction of records; making false statements; or receiving stolen property;
- c. are not presently indicted for, or criminally or civilly charged by, a governmental entity (federal, state or local) with committing any of the offenses set forth in clause B.2.b. of this Section V;
- d. have not, within a five-year period preceding the date of this EDS, had one or more public transactions (federal, state or local) terminated for cause or default; and
- e. have not, within a five-year period preceding the date of this EDS, been convicted, adjudged guilty, or found liable in a civil proceeding, or in any criminal or civil action, including actions concerning environmental violations, instituted by the City or by the federal government, any state, or any other unit of local government.

3. The certifications in subparts 3, 4 and 5 concern:

- the Disclosing Party;
- any "Contractor" (meaning any contractor or subcontractor used by the Disclosing Party in connection with the Matter, including but not limited to all persons or legal entities disclosed under Section IV, "Disclosure of Subcontractors and Other Retained Parties");
- any "Affiliated Entity" (meaning a person or entity that, directly or indirectly: controls the Disclosing Party, is controlled by the Disclosing Party, or is, with the Disclosing Party, under common control of another person or entity. Indicia of control include, without limitation: interlocking management or ownership; identity of interests among family members, shared facilities and equipment; common use of employees; or organization of a business entity following the ineligibility of a business entity to do business with federal or state or local government, including the City, using substantially the same management, ownership, or principals as the ineligible entity); with respect to Contractors, the term Affiliated Entity means a person or entity that directly or indirectly controls the Contractor, is controlled by it, or, with the Contractor, is under common control of another person or entity;
- any responsible official of the Disclosing Party, any Contractor or any Affiliated Entity or any other official, agent or employee of the Disclosing Party, any Contractor or any Affiliated Entity, acting pursuant to the direction or authorization of a responsible official of the Disclosing Party, any Contractor or any Affiliated Entity (collectively "Agents").

Neither the Disclosing Party, nor any Contractor, nor any Affiliated Entity of either the Disclosing Party or any Contractor nor any Agents have, during the five years before the date this EDS is signed, or, with respect to a Contractor, an Affiliated Entity, or an Affiliated Entity of a Contractor during the five years before the date of such Contractor's or Affiliated Entity's contract or engagement in connection with the Matter:

- a. bribed or attempted to bribe, or been convicted or adjudged guilty of bribery or attempting to bribe, a public officer or employee of the City, the State of Illinois, or any agency of the federal government or of any state or local government in the United States of America, in that officer's or employee's official capacity;
- b. agreed or colluded with other bidders or prospective bidders, or been a party to any such agreement, or been convicted or adjudged guilty of agreement or collusion among bidders or prospective bidders, in restraint of freedom of competition by agreement to bid a fixed price or otherwise; or
- c. made an admission of such conduct described in a. or b. above that is a matter of record, but have not been prosecuted for such conduct; or
- d. violated the provisions of Municipal Code Section 2-92-610 (Living Wage Ordinance).

4. Neither the Disclosing Party, Affiliated Entity or Contractor, or any of their employees, officials, agents or partners, is barred from contracting with any unit of state or local government as a result of engaging in or being convicted of (1) bid-rigging in violation of 720 ILCS 5/33E-3; (2) bid-rotating in violation of 720 ILCS 5/33E-4; or (3) any similar offense of any state or of the United States of America that contains the same elements as the offense of bid-rigging or bid-rotating.

5. Neither the Disclosing Party nor any Affiliated Entity is listed on any of the following lists maintained by the Office of Foreign Assets Control of the U.S. Department of the Treasury or the Bureau of Industry and Security of the U.S. Department of Commerce or their successors: the Specially Designated Nationals List, the Denied Persons List, the Unverified List, the Entity List and the Debarred List.

6. The Disclosing Party understands and shall comply with the applicable requirements of Chapters 2-55 (Legislative Inspector General), 2-56 (Inspector General) and 2-156 (Governmental Ethics) of the Municipal Code.

7. If the Disclosing Party is unable to certify to any of the above statements in this Part B (Further Certifications), the Disclosing Party must explain below:

N/A

If the letters "NA," the word "None," or no response appears on the lines above, it will be conclusively presumed that the Disclosing Party certified to the above statements.

8. To the best of the Disclosing Party's knowledge after reasonable inquiry, the following is a complete list of all current employees of the Disclosing Party who were, at any time during the 12-month period preceding the execution date of this EDS, an employee, or elected or appointed official, of the City of Chicago (if none, indicate with "N/A" or "none").

N/A

9. To the best of the Disclosing Party's knowledge after reasonable inquiry, the following is a complete list of all gifts that the Disclosing Party has given or caused to be given, at any time during the 12-month period preceding the execution date of this EDS, to an employee, or elected or appointed official, of the City of Chicago. For purposes of this statement, a "gift" does not include: (i) anything made generally available to City employees or to the general public, or (ii) food or drink provided in the course of official City business and having a retail value of less than \$20 per recipient (if none, indicate with "N/A" or "none"). As to any gift listed below, please also list the name of the City recipient.

N/A

C. CERTIFICATION OF STATUS AS FINANCIAL INSTITUTION

1. The Disclosing Party certifies that the Disclosing Party (check one)

is is not

a "financial institution" as defined in Section 2-32-455(b) of the Municipal Code.

2. If the Disclosing Party IS a financial institution, then the Disclosing Party pledges:

"We are not and will not become a predatory lender as defined in Chapter 2-32 of the Municipal Code. We further pledge that none of our affiliates is, and none of them will become, a predatory lender as defined in Chapter 2-32 of the Municipal Code. We understand that becoming a predatory lender or becoming an affiliate of a predatory lender may result in the loss of the privilege of doing business with the City."

If the Disclosing Party is unable to make this pledge because it or any of its affiliates (as defined in Section 2-32-455(b) of the Municipal Code) is a predatory lender within the meaning of Chapter 2-32 of the Municipal Code, explain here (attach additional pages if necessary):

N/A

If the letters "NA," the word "None," or no response appears on the lines above, it will be conclusively presumed that the Disclosing Party certified to the above statements.

D. CERTIFICATION REGARDING INTEREST IN CITY BUSINESS

Any words or terms that are defined in Chapter 2-156 of the Municipal Code have the same meanings when used in this Part D.

1. In accordance with Section 2-156-110 of the Municipal Code: Does any official or employee of the City have a financial interest in his or her own name or in the name of any other person or entity in the Matter?

Yes No

NOTE: If you checked "Yes" to Item D.1., proceed to Items D.2. and D.3. If you checked "No" to Item D.1., proceed to Part E.

2. Unless sold pursuant to a process of competitive bidding, or otherwise permitted, no City elected official or employee shall have a financial interest in his or her own name or in the name of any other person or entity in the purchase of any property that (i) belongs to the City, or (ii) is sold for taxes or assessments, or (iii) is sold by virtue of legal process at the suit of the City (collectively, "City Property Sale"). Compensation for property taken pursuant to the City's eminent domain power does not constitute a financial interest within the meaning of this Part D.

Does the Matter involve a City Property Sale?

Yes No

3. If you checked "Yes" to Item D.1., provide the names and business addresses of the City officials or employees having such interest and identify the nature of such interest:

Name	Business Address	Nature of Interest
N/A		

4. The Disclosing Party further certifies that no prohibited financial interest in the Matter will be acquired by any City official or employee.

E. CERTIFICATION REGARDING SLAVERY ERA BUSINESS

Please check either 1. or 2. below. If the Disclosing Party checks 2., the Disclosing Party must disclose below or in an attachment to this EDS all information required by paragraph 2. Failure to

comply with these disclosure requirements may make any contract entered into with the City in connection with the Matter voidable by the City.

X 1. The Disclosing Party verifies that the Disclosing Party has searched any and all records of the Disclosing Party and any and all predecessor entities regarding records of investments or profits from slavery or slaveholder insurance policies during the slavery era (including insurance policies issued to slaveholders that provided coverage for damage to or injury or death of their slaves), and the Disclosing Party has found no such records.

____ 2. The Disclosing Party verifies that, as a result of conducting the search in step 1 above, the Disclosing Party has found records of investments or profits from slavery or slaveholder insurance policies. The Disclosing Party verifies that the following constitutes full disclosure of all such records, including the names of any and all slaves or slaveholders described in those records:

SECTION VI -- CERTIFICATIONS FOR FEDERALLY FUNDED MATTERS

NOTE: If the Matter is federally funded, complete this Section VI. If the Matter is not federally funded, proceed to Section VII. For purposes of this Section VI, tax credits allocated by the City and proceeds of debt obligations of the City are not federal funding.

A. CERTIFICATION REGARDING LOBBYING

1. List below the names of all persons or entities registered under the federal Lobbying Disclosure Act of 1995 who have made lobbying contacts on behalf of the Disclosing Party with respect to the Matter: (Add sheets if necessary):

(If no explanation appears or begins on the lines above, or if the letters "NA" or if the word "None" appear, it will be conclusively presumed that the Disclosing Party means that NO persons or entities registered under the Lobbying Disclosure Act of 1995 have made lobbying contacts on behalf of the Disclosing Party with respect to the Matter.)

2. The Disclosing Party has not spent and will not expend any federally appropriated funds to pay any person or entity listed in Paragraph A.1. above for his or her lobbying activities or to pay any person or entity to influence or attempt to influence an officer or employee of any agency, as defined by applicable federal law, a member of Congress, an officer or employee of Congress, or an employee of a member of Congress, in connection with the award of any federally funded contract, making any federally funded grant or loan, entering into any cooperative agreement, or to extend, continue, renew, amend, or modify any federally funded contract, grant, loan, or cooperative agreement.

3. The Disclosing Party will submit an updated certification at the end of each calendar quarter in which there occurs any event that materially affects the accuracy of the statements and information set forth in paragraphs A.1. and A.2. above.

4. The Disclosing Party certifies that either: (i) it is not an organization described in section 501(c)(4) of the Internal Revenue Code of 1986; or (ii) it is an organization described in section 501(c)(4) of the Internal Revenue Code of 1986 but has not engaged and will not engage in "Lobbying Activities".

5. If the Disclosing Party is the Applicant, the Disclosing Party must obtain certifications equal in form and substance to paragraphs A.1. through A.4. above from all subcontractors before it awards any subcontract and the Disclosing Party must maintain all such subcontractors' certifications for the duration of the Matter and must make such certifications promptly available to the City upon request.

B. CERTIFICATION REGARDING EQUAL EMPLOYMENT OPPORTUNITY

If the Matter is federally funded, federal regulations require the Applicant and all proposed subcontractors to submit the following information with their bids or in writing at the outset of negotiations.

Is the Disclosing Party the Applicant?

Yes

No

If "Yes," answer the three questions below:

1. Have you developed and do you have on file affirmative action programs pursuant to applicable federal regulations? (See 41 CFR Part 60-2.)

Yes

No

2. Have you filed with the Joint Reporting Committee, the Director of the Office of Federal Contract Compliance Programs, or the Equal Employment Opportunity Commission all reports due under the applicable filing requirements?

Yes

No

3. Have you participated in any previous contracts or subcontracts subject to the equal opportunity clause?

Yes

No

If you checked "No" to question 1. or 2. above, please provide an explanation:

**SECTION VII -- ACKNOWLEDGMENTS, CONTRACT INCORPORATION,
COMPLIANCE, PENALTIES, DISCLOSURE**

The Disclosing Party understands and agrees that:

A. The certifications, disclosures, and acknowledgments contained in this EDS will become part of any contract or other agreement between the Applicant and the City in connection with the Matter, whether procurement, City assistance, or other City action, and are material inducements to the City's execution of any contract or taking other action with respect to the Matter. The Disclosing Party understands that it must comply with all statutes, ordinances, and regulations on which this EDS is based.

B. The City's Governmental Ethics and Campaign Financing Ordinances, Chapters 2-156 and 2-164 of the Municipal Code, impose certain duties and obligations on persons or entities seeking City contracts, work, business, or transactions. The full text of these ordinances and a training program is available on line at www.cityofchicago.org/Ethics, and may also be obtained from the City's Board of Ethics, 740 N.

Sedgwick St., Suite 500, Chicago, IL 60610, (312) 744-9660. The Disclosing Party must comply fully with the applicable ordinances.

C. If the City determines that any information provided in this EDS is false, incomplete or inaccurate, any contract or other agreement in connection with which it is submitted may be rescinded or be void or voidable, and the City may pursue any remedies under the contract or agreement (if not rescinded or void), at law, or in equity, including terminating the Disclosing Party's participation in the Matter and/or declining to allow the Disclosing Party to participate in other transactions with the City. Remedies at law for a false statement of material fact may include incarceration and an award to the City of treble damages.

D. It is the City's policy to make this document available to the public on its Internet site and/or upon request. Some or all of the information provided on this EDS and any attachments to this EDS may be made available to the public on the Internet, in response to a Freedom of Information Act request, or otherwise. By completing and signing this EDS, the Disclosing Party waives and releases any possible rights or claims which it may have against the City in connection with the public release of information contained in this EDS and also authorizes the City to verify the accuracy of any information submitted in this EDS.

E. The information provided in this EDS must be kept current. In the event of changes, the Disclosing Party must supplement this EDS up to the time the City takes action on the Matter. If the Matter is a contract being handled by the City's Department of Procurement Services, the Disclosing Party must update this EDS as the contract requires. **NOTE:** With respect to Matters subject to Article I of Chapter 1-23 of the Municipal Code (imposing **PERMANENT INELIGIBILITY** for certain specified offenses), the information provided herein regarding eligibility must be kept current for a longer period, as required by Chapter 1-23 and Section 2-154-020 of the Municipal Code.

The Disclosing Party represents and warrants that:

F.1. The Disclosing Party is not delinquent in the payment of any tax administered by the Illinois Department of Revenue, nor are the Disclosing Party or its Affiliated Entities delinquent in paying any fine, fee, tax or other charge owed to the City. This includes, but is not limited to, all water charges, sewer charges, license fees, parking tickets, property taxes or sales taxes.

F.2 If the Disclosing Party is the Applicant, the Disclosing Party and its Affiliated Entities will not use, nor permit their subcontractors to use, any facility listed by the U.S. E.P.A. on the federal Excluded Parties List System ("EPLS") maintained by the U. S. General Services Administration.

F.3 If the Disclosing Party is the Applicant, the Disclosing Party will obtain from any contractors/subcontractors hired or to be hired in connection with the Matter certifications equal in form and substance to those in F.1. and F.2. above and will not, without the prior written consent of the City, use any such contractor/subcontractor that does not provide such certifications or that the Disclosing Party has reason to believe has not provided or cannot provide truthful certifications.

NOTE: If the Disclosing Party cannot certify as to any of the items in F.1., F.2. or F.3. above, an explanatory statement must be attached to this EDS.

CERTIFICATION

Under penalty of perjury, the person signing below: (1) warrants that he/she is authorized to execute this EDS and Appendix A (if applicable) on behalf of the Disclosing Party, and (2) warrants that all certifications and statements contained in this EDS and Appendix A (if applicable) are true, accurate and complete as of the date furnished to the City.

Drona Group, LLC

(Print or type name of Disclosing Party)

By: *Chayuna*
(Sign here)

(Print or type name of person signing)

(Print or type title of person signing)

Signed and sworn to before me on (date) 10/25/2012,
at Cook County, IL (state).

Lesley D Magnabosco Notary Public.

Commission expires: 10/25/2015.

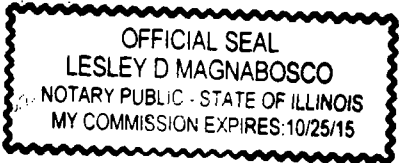

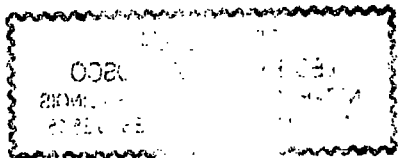

**CITY OF CHICAGO
ECONOMIC DISCLOSURE STATEMENT AND AFFIDAVIT
APPENDIX A**

FAMILIAL RELATIONSHIPS WITH ELECTED CITY OFFICIALS AND DEPARTMENT HEADS

This Appendix is to be completed only by (a) the Applicant, and (b) any legal entity which has a direct ownership interest in the Applicant exceeding 7.5 percent. It is not to be completed by any legal entity which has only an indirect ownership interest in the Applicant.

Under Municipal Code Section 2-154-015, the Disclosing Party must disclose whether such Disclosing Party or any "Applicable Party" or any Spouse or Domestic Partner thereof currently has a "familial relationship" with any elected city official or department head. A "familial relationship" exists if, as of the date this EDS is signed, the Disclosing Party or any "Applicable Party" or any Spouse or Domestic Partner thereof is related to the mayor, any alderman, the city clerk, the city treasurer or any city department head as spouse or domestic partner or as any of the following, whether by blood or adoption: parent, child, brother or sister, aunt or uncle, niece or nephew, grandparent, grandchild, father-in-law, mother-in-law, son-in-law, daughter-in-law, stepfather or stepmother, stepson or stepdaughter, stepbrother or stepsister or half-brother or half-sister.

"Applicable Party" means (1) all executive officers of the Disclosing Party listed in Section II.B.1.a., if the Disclosing Party is a corporation; all partners of the Disclosing Party, if the Disclosing Party is a general partnership; all general partners and limited partners of the Disclosing Party, if the Disclosing Party is a limited partnership; all managers, managing members and members of the Disclosing Party, if the Disclosing Party is a limited liability company; (2) all principal officers of the Disclosing Party; and (3) any person having more than a 7.5 percent ownership interest in the Disclosing Party. "Principal officers" means the president, chief operating officer, executive director, chief financial officer, treasurer or secretary of a legal entity or any person exercising similar authority.

Does the Disclosing Party or any "Applicable Party" or any Spouse or Domestic Partner thereof currently have a "familial relationship" with an elected city official or department head?

Yes

No

If yes, please identify below (1) the name and title of such person, (2) the name of the legal entity to which such person is connected; (3) the name and title of the elected city official or department head to whom such person has a familial relationship, and (4) the precise nature of such familial relationship.

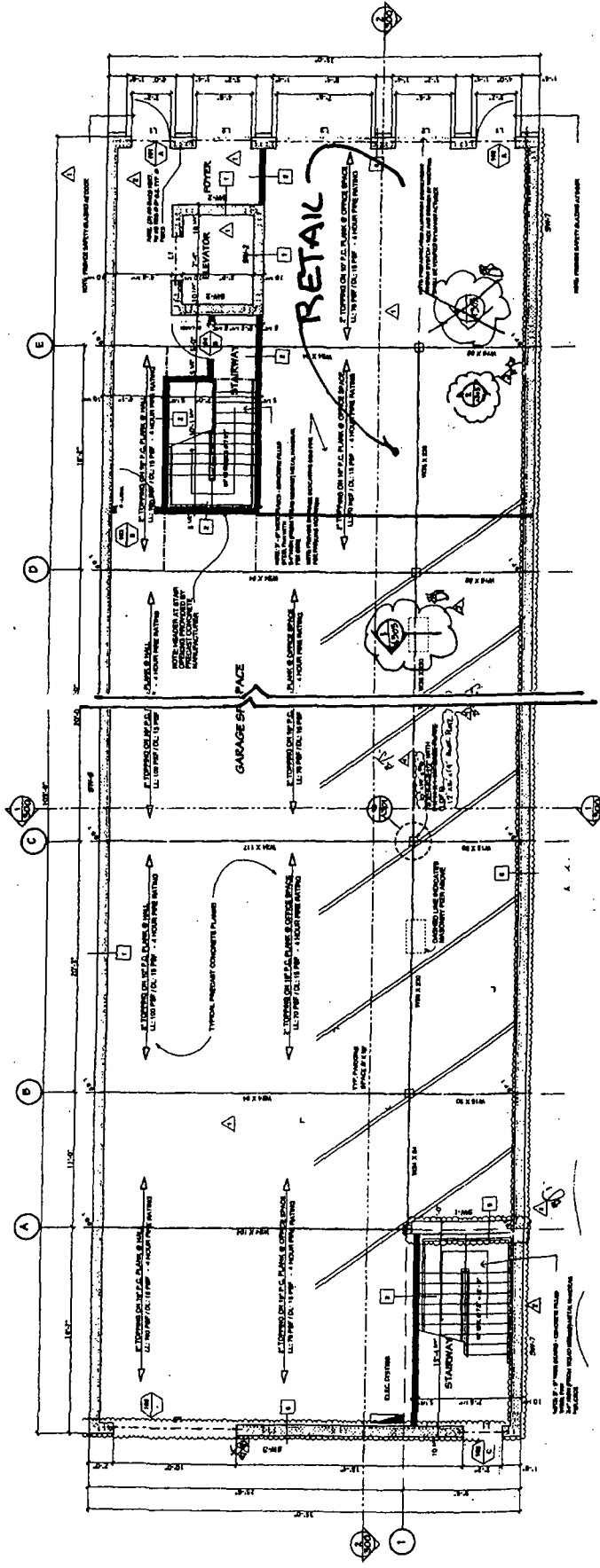

F



1/4" = 1'-0"

1 A101 FIRST FLOOR PLAN
N.C.

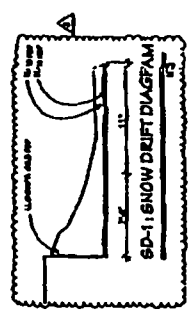
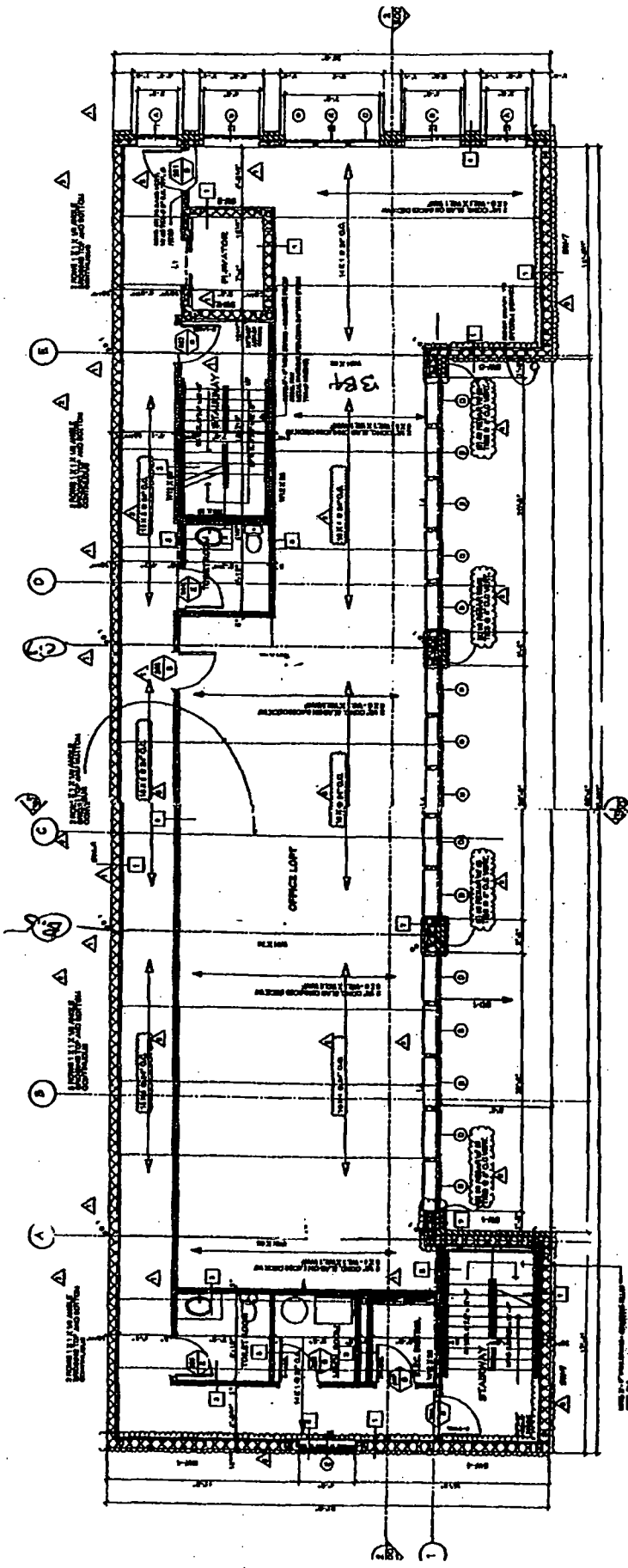

SECOND FLOOR (N.C.)

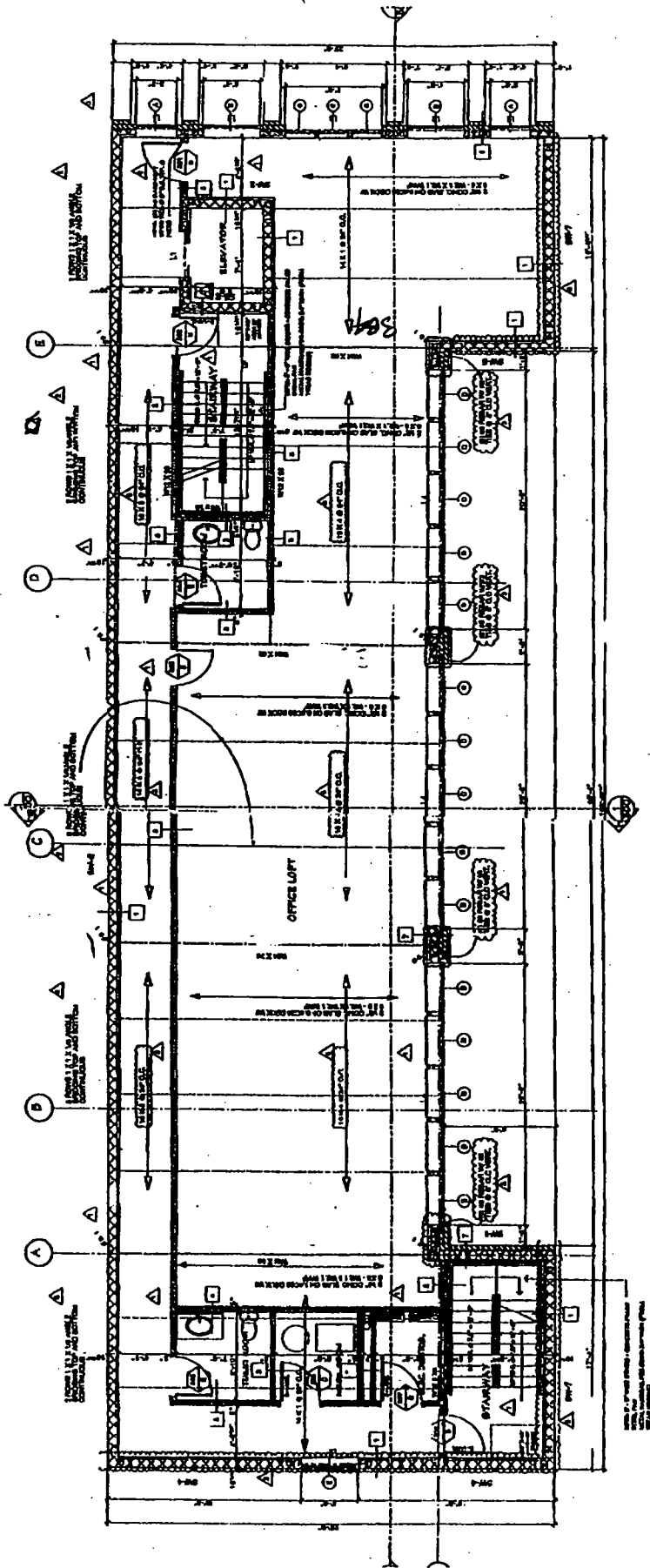

THIRD FLOOR (N.C.)

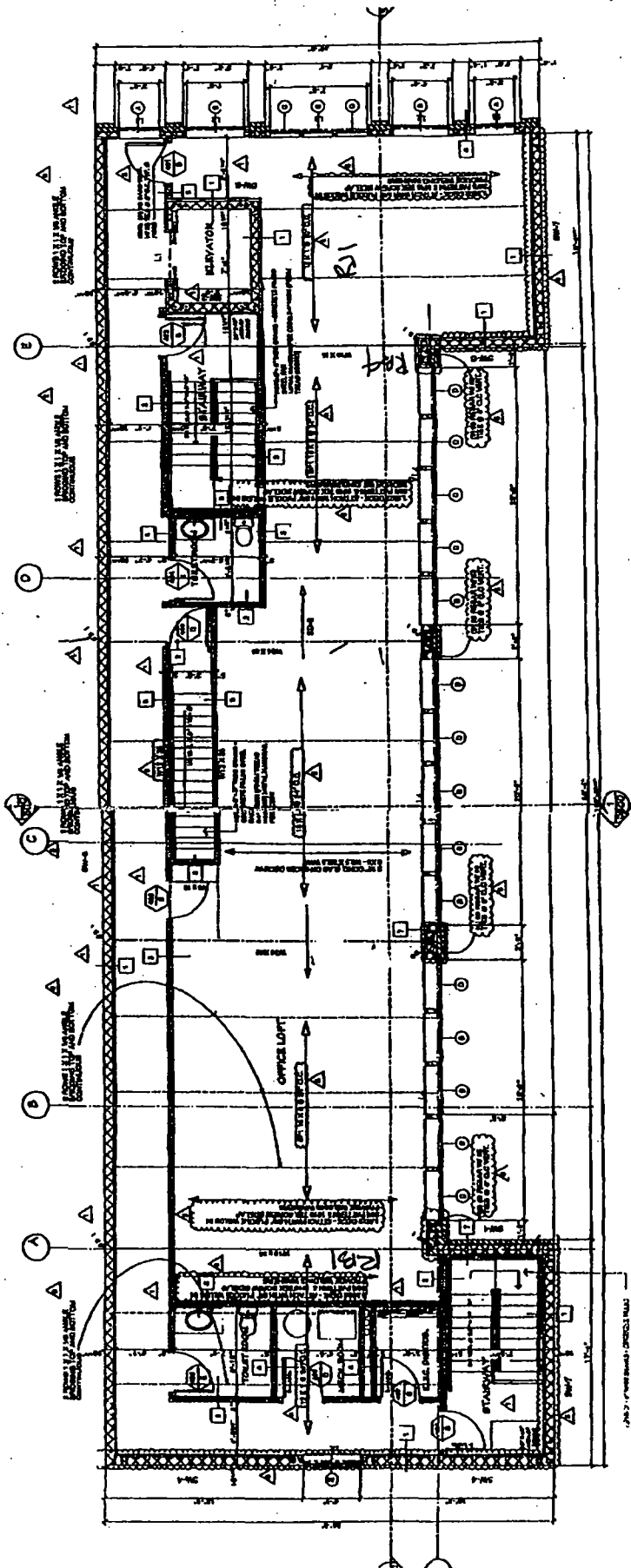

FOURTH FLOOR (N.C.)

MECHANICAL PENTHOUSE (N.C.)

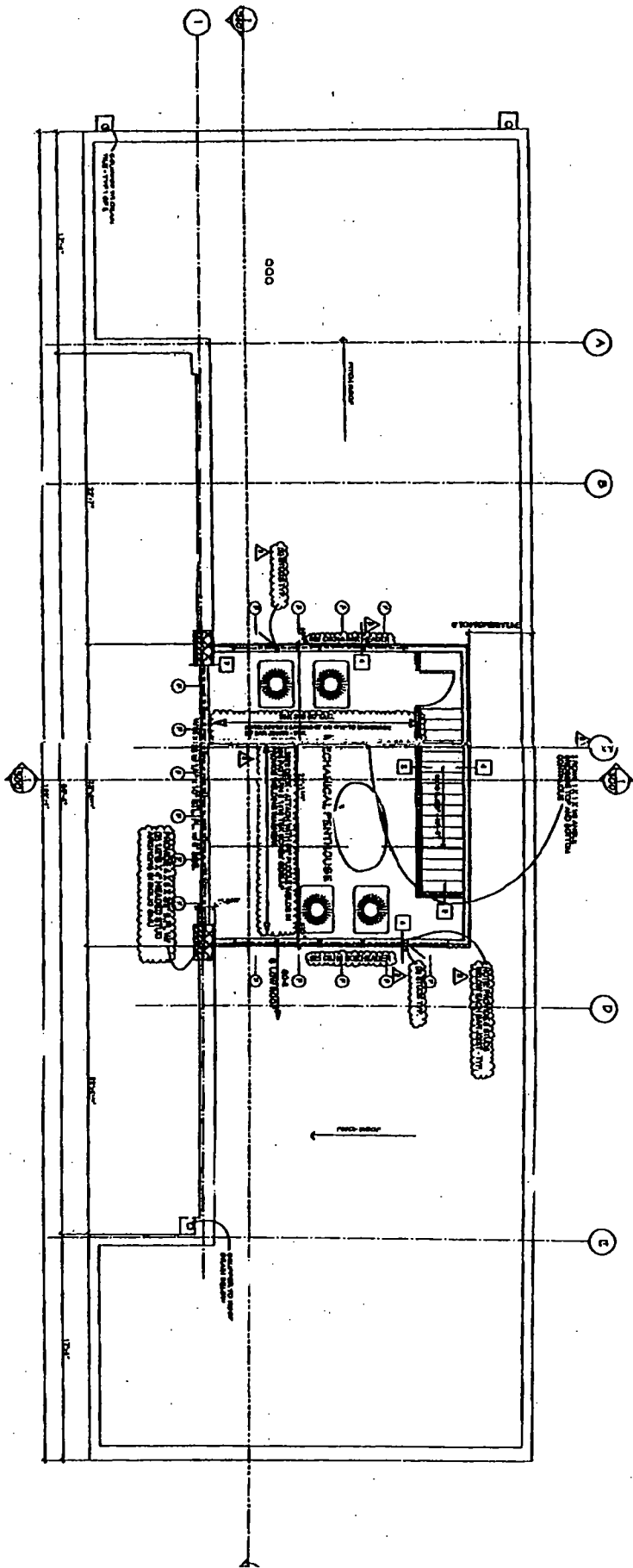

NO CHANGE TO ELEVATION

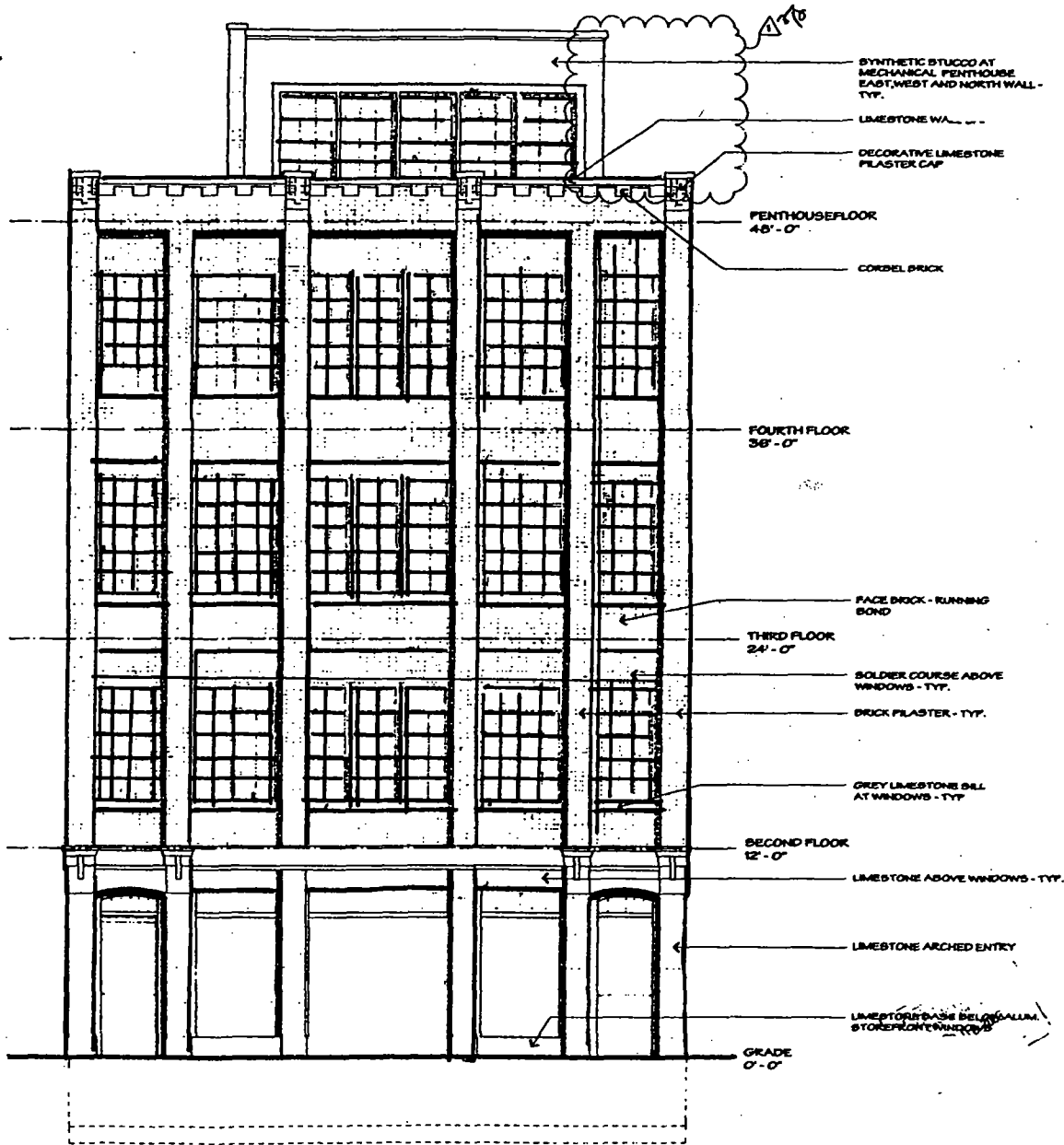

SYNTHETIC STUCCO AT MECHANICAL PENTHOUSE EAST, WEST AND NORTH WALL - TYP.
 LIMESTONE WALL - TYP.
 DECORATIVE LIMESTONE PLASTER CAP

PENTHOUSE FLOOR
 48'-0"

CORDEL BRICK

FOURTH FLOOR
 36'-0"

FACE BRICK - RUNNING BOND

THIRD FLOOR
 24'-0"

SOLDIER COURSE ABOVE WINDOWS - TYP.

BRICK PLASTER - TYP.

GREY LIMESTONE SILL AT WINDOWS - TYP.

SECOND FLOOR
 12'-0"

LIMESTONE ABOVE WINDOWS - TYP.

LIMESTONE ARCHED ENTRY

LIMESTONE BASE BELOW GALLUM STOREFRONT WINDOWS

GRADE
 0'-0"

P . R . O . J . E . C . T

2232 N. CLYBOURN
 2232 N. CLYBOURN
 CHICAGO, ILL.

COPYRIGHT
 1920-1921
 1922-1923
 1924-1925
 1926-1927
 1928-1929
 1930-1931
 1932-1933
 1934-1935
 1936-1937
 1938-1939
 1940-1941
 1942-1943
 1944-1945
 1946-1947
 1948-1949
 1950-1951
 1952-1953
 1954-1955
 1956-1957
 1958-1959
 1960-1961
 1962-1963
 1964-1965
 1966-1967
 1968-1969
 1970-1971
 1972-1973
 1974-1975
 1976-1977
 1978-1979
 1980-1981
 1982-1983
 1984-1985
 1986-1987
 1988-1989
 1990-1991
 1992-1993
 1994-1995
 1996-1997
 1998-1999
 2000-2001
 2002-2003
 2004-2005
 2006-2007
 2008-2009
 2010-2011
 2012-2013
 2014-2015
 2016-2017
 2018-2019
 2020-2021

REVISION:
 1. 11-15-20 PERMITTED

2
 A200

EAST ELEVATION
 CLYBOURN

1/4" = 1'-0"

EXISTING
ELEVATIONS N.C.

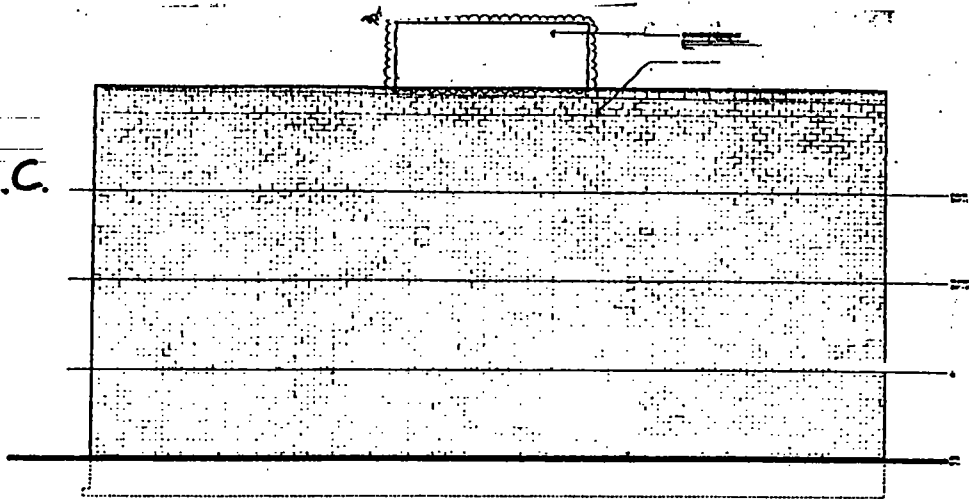

2 NORTH ELEVATION

7'-10'-0"

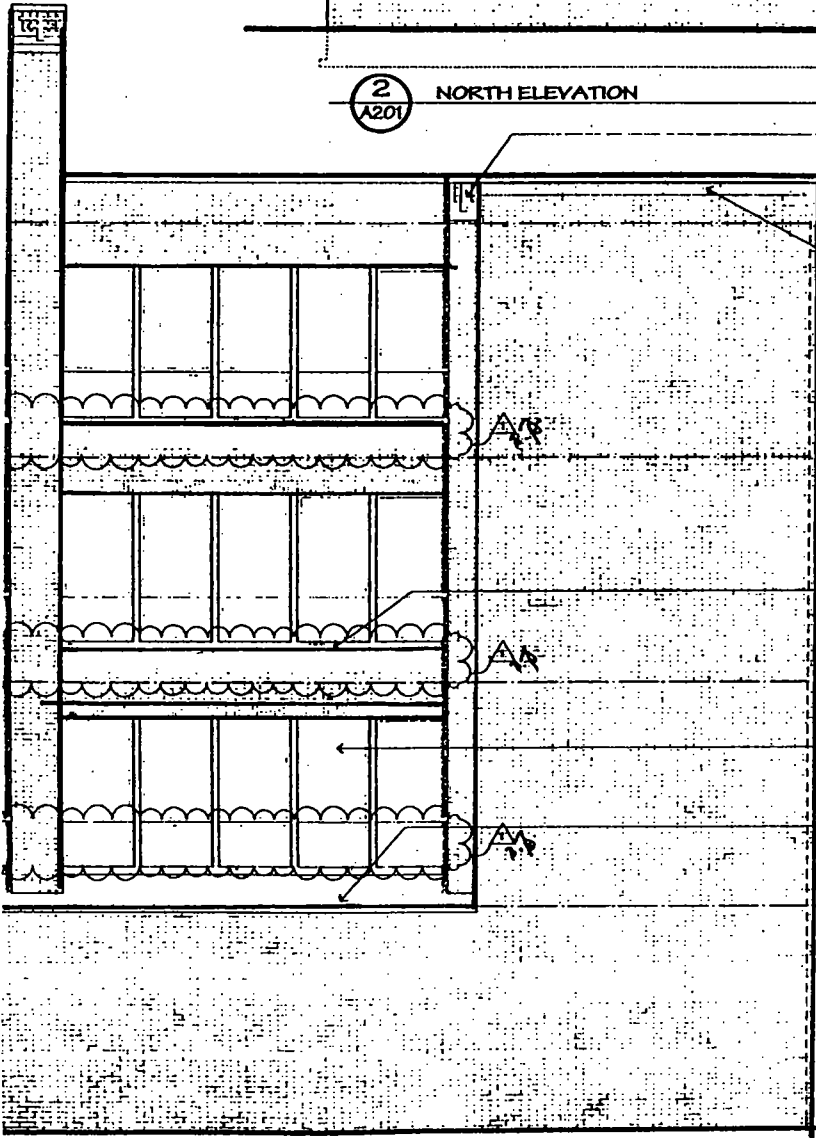

DECORATIVE LIMESTONE
PLASTER CAP

PENTHOUSE FLOOR
45'-0"

BOLDER COURSE OVER
WINDOWS - TYP.

FOURTH FLOOR
36'-0"

LIMESTONE SILL AT WINDOW -
TYP.

THIRD FLOOR
24'-0"

FIXED ALUMINUM WINDOW
WITH OPERABLE HOPPER
WINDOW BELOW

EPDM ROOF - FITTED
TOWARD SIDE LOT

SECOND FLOOR
12'-0"

GRADE
0'-0"

NORTH ELEVATION

P . R . O . J . E . C . T

2232 N. CLYBOURN

888 N. CLYBOURN
CHICAGO, IL

COPYRIGHT

© 1998 BY SCHUBERT ASSOCIATES, INC.

ALL RIGHTS RESERVED.

NO PART OF THIS DOCUMENT IS TO BE REPRODUCED OR TRANSMITTED IN ANY FORM OR BY ANY MEANS, ELECTRONIC OR MECHANICAL, INCLUDING PHOTOCOPYING, RECORDING, OR BY ANY INFORMATION STORAGE AND RETRIEVAL SYSTEM, WITHOUT PERMISSION IN WRITING FROM SCHUBERT ASSOCIATES, INC.

REVISION:

Δ 11.15.00. PER. INSET.

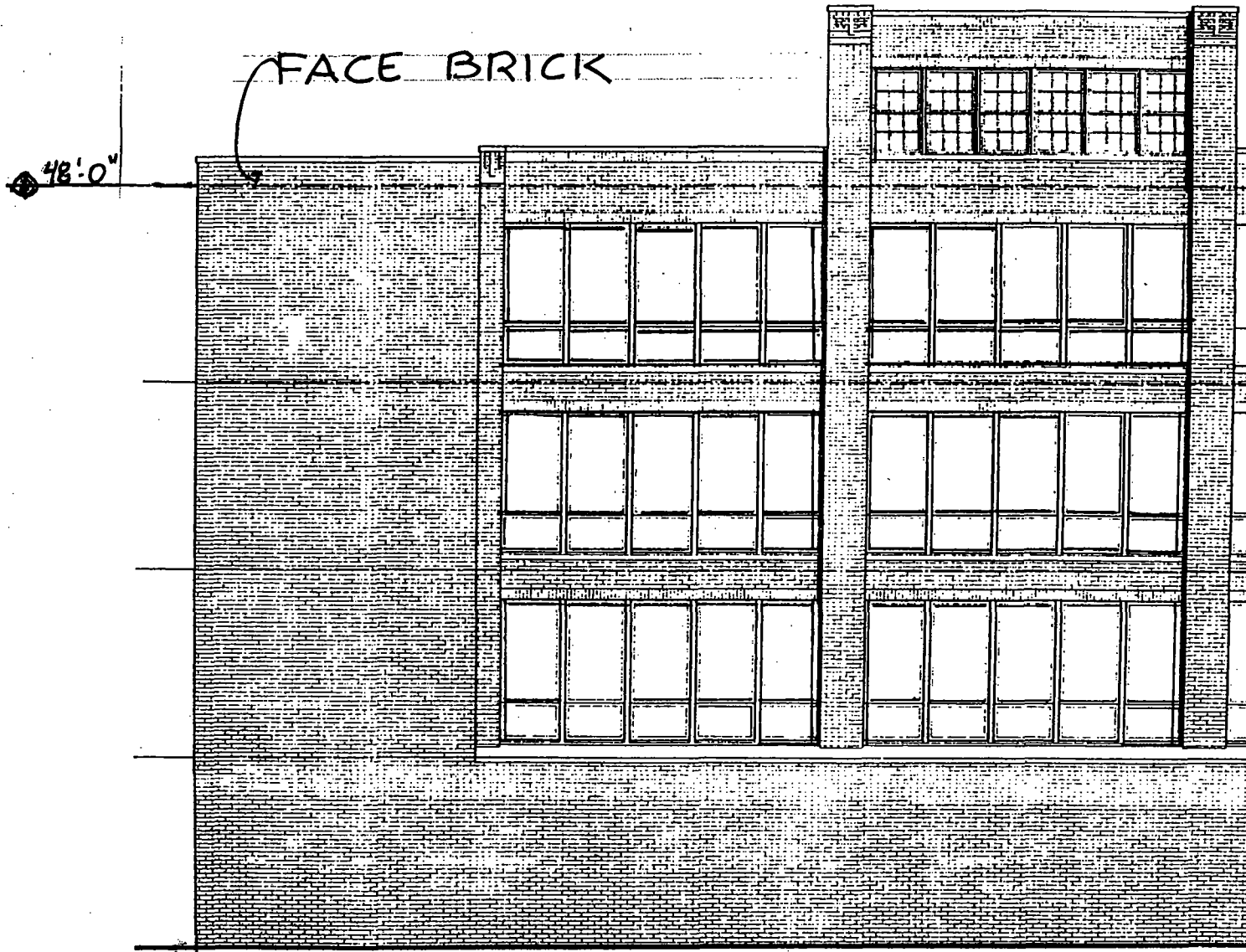

① SOUTH ELEVATION

1/4" = 1'-0"

EXISTING ELEVATION N.C.

NO CHANGE TO ELEVATION

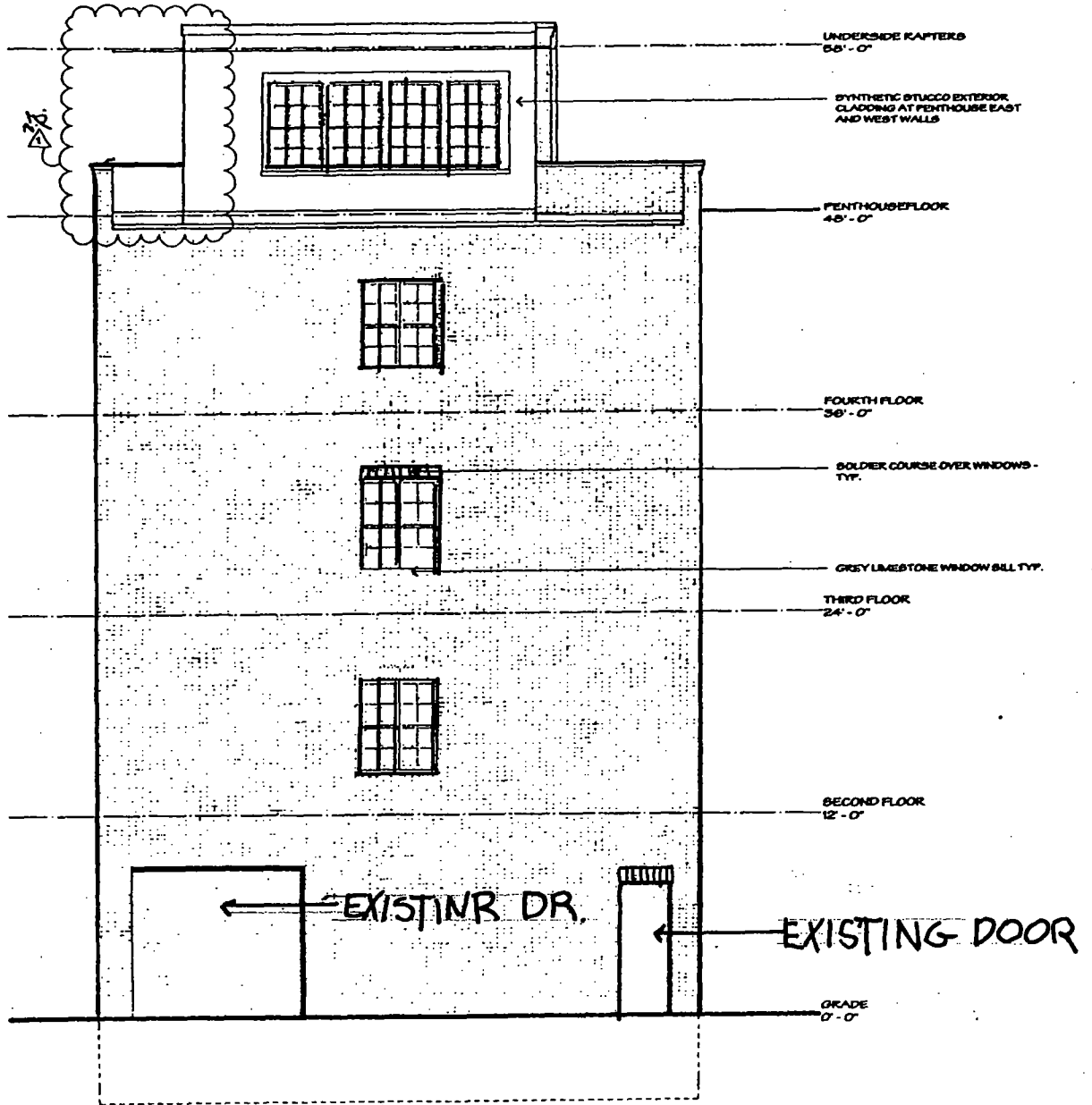

1
A200

WEST ELEVATION

1/4" = 1'-0"

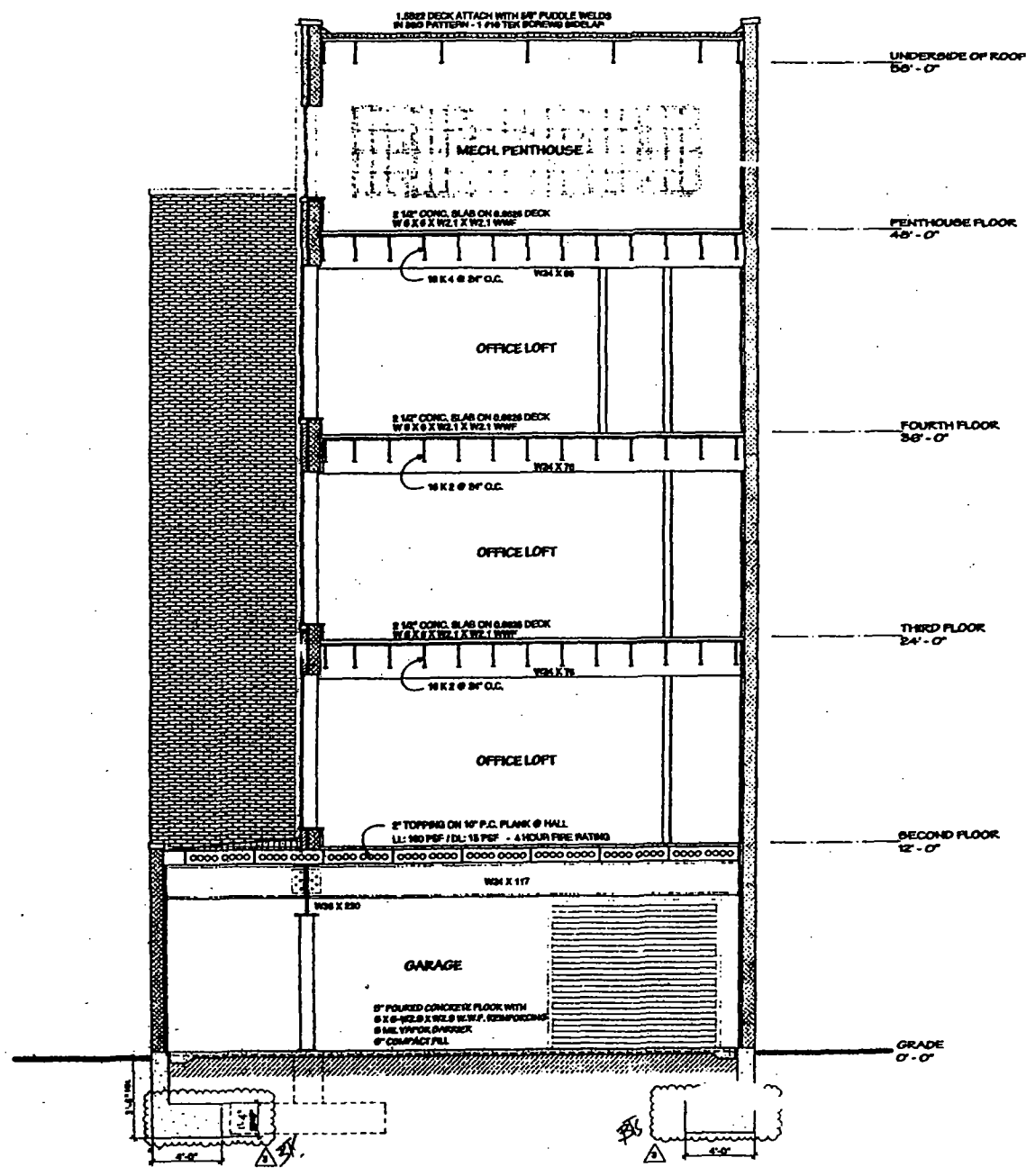

1
A300

BUILDING SECTION

1/4" = 1'-0"

PROFESSIONALS ASSOCIATED SURVEY, INC.

PROFESSIONAL DESIGN FIRM NO. 184-003023

7100 N. TRIPP AVENUE
LINCOLNWOOD, ILLINOIS 60712
www.professionalsassociated.com

TEL: (847) 675-3000
FAX: (847) 675-2167
e-mail: pa@professionalsassociated.com

PLAT OF SURVEY

OF

THE NORTHWESTERLY 13 FEET OF LOT 12 AND THE SOUTHEASTERLY 22 FEET OF LOT 13 IN BLOCK 4 IN NICKERSON'S ADDITION TO CHICAGO, A SUBDIVISION OF THE WEST 1/2 OF BLOCK 15 AND SUB BLOCK 5 OF THE EAST 1/2 OF BLOCK 15 IN SHEFFIELDS ADDITION TO CHICAGO, COOK COUNTY, ILLINOIS.

LAND TOTAL AREA: = 4,199.98 SQ.FT. = 0.096 ACRES.

COMMONLY KNOWN AS: 2232 NORTH CLYBOURN AVENUE, CHICAGO, ILLINOIS.

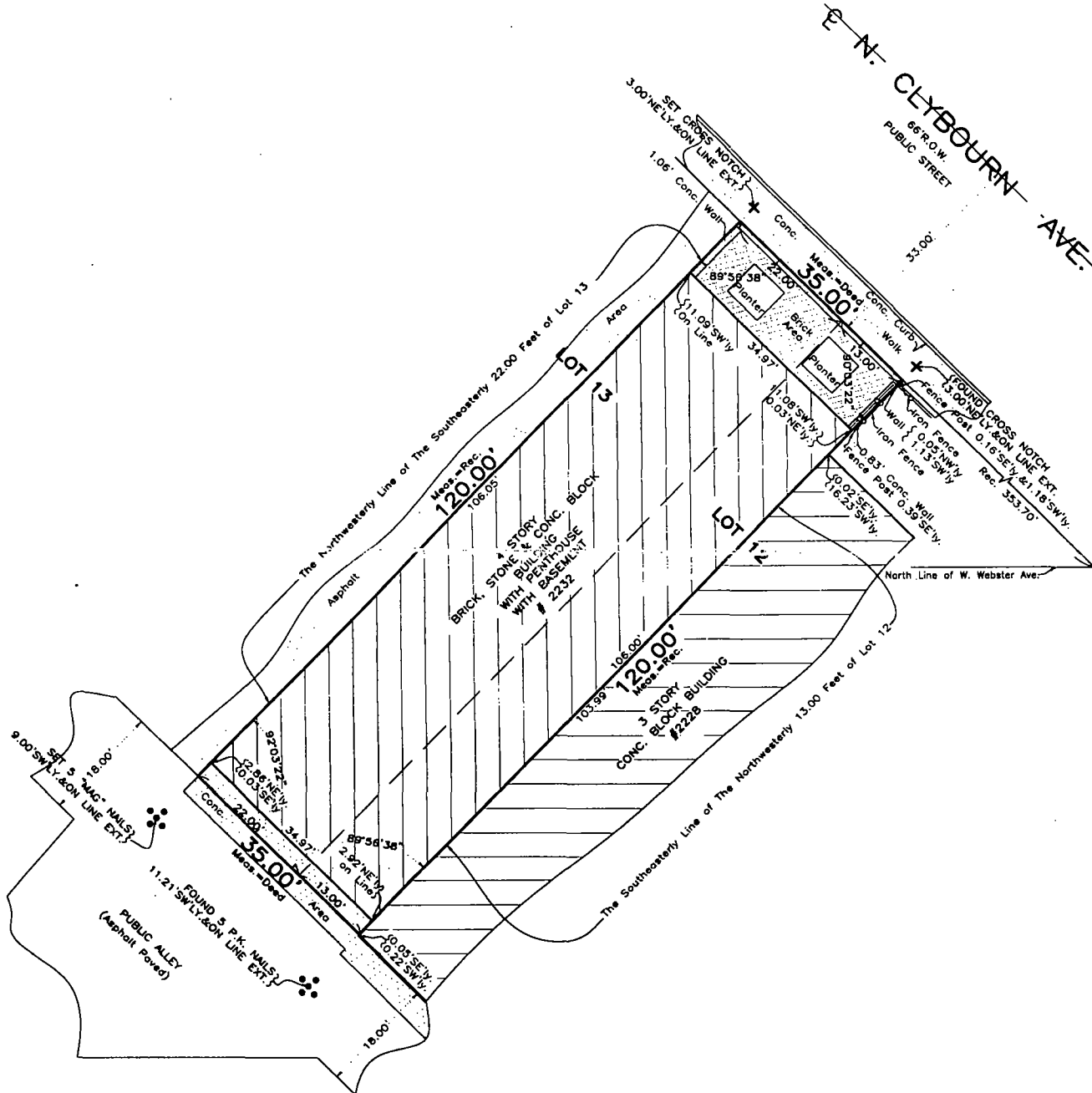

THE LEGAL DESCRIPTION SHOWN ON THE PLAT HERON DRAWN IS A COPY OF THE ORDER, AND FOR ACCURACY SHOULD BE COMPARED WITH THE TITLE OR DEED. DIMENSIONS ARE NOT TO BE ASSUMED FROM SCALING. BUILDING LINES AND EASEMENTS ARE SHOWN ONLY WHERE THEY ARE SO RECORDED IN THE MAPS, OTHERWISE REFER TO YOUR DEED OR ABSTRACT.

Order No. 01-57511 feet.

Scale: 1 inch = 16 feet.

Date of Field Work: October 5, 2012.

Ordered by: DRONA GROUP, LLC

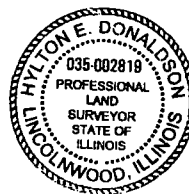

THIS PROFESSIONAL SERVICE CONFORMS TO THE CURRENT ILLINOIS MINIMUM STANDARDS FOR A BOUNDARY SURVEY.

THIS SURVEY HAS BEEN ORDERED FOR SURFACE DIMENSIONS ONLY, NOT FOR ELEVATIONS. THIS IS NOT AN ALTA SURVEY.

COMPARE ALL POINTS BEFORE BUILDING BY SAME AND AT ONCE REPORT ANY DIFFERENCE.

State of Illinois
County of Cook

We, PROFESSIONALS ASSOCIATED SURVEY INC., do hereby certify that we have surveyed the above described property and that, to the best of our knowledge, the plat heron drawn is an accurate representation of said survey.

Date: October 8, 2012.

Hylon E. Donaldson

ILL. PROF. LAND SURVEYOR - LICENSE EXP. DATE NOV. 30, 2012.

Drawn by: D.B.- J.V.