



# City of Chicago



O2017-6181

Office of the City Clerk

## Document Tracking Sheet

<b>Meeting Date:</b>	9/6/2017
<b>Sponsor(s):</b>	Misc. Transmittal
<b>Type:</b>	Ordinance
<b>Title:</b>	Zoning Reclassification Map No. 3-G at 1515 W Walton St - App No. 19350T1
<b>Committee(s) Assignment:</b>	Committee on Zoning, Landmarks and Building Standards

#19350 T1  
INTRO. DATE  
SEPT. 6, 2017

**ORDINANCE**

**BE IT ORDAINED BY THE CITY COUNCIL OF THE CITY OF CHICAGO:**

**SECTION 1.** Title 17 of the Municipal Code of Chicago, the Chicago Zoning Ordinance, is hereby amended by changing all of the RS-3 Residential Single-Unit (Detached House) District, as shown on Map 3-G in the area bounded by:

**West Walton Street, a line 150 feet West of North Greenview Avenue, the alley South and parallel to West Walton Street and a line 175 feet West of North Greenview Avenue.**

To those of **RM-4.5** Residential Multi-Unit District

**SECTION 2.** This ordinance shall be in force and effect from and after its passage and due publication.

Common Address of Property: 1515 West Walton, Chicago, IL

**NARRATIVE AND PLANS  
FOR THE PROPOSED REZONING  
AT  
1515 WEST WALTON STREET**

The Application is to change zoning for 1515 West Walton from RS-3 to RM-4.5 Residential Multi-Unit District. This zoning change is for purposes to allow Applicant to construct a three-story, three dwelling unit building with a basement. There will be a three car garage at the rear of the property. The footprint of the building shall be approximately be 20 feet by 78 feet 7 inches in size. The building height shall be 37 feet 8 inches high, as defined by code.

**LOT AREA:** 3,200 SQUARE FEET

**FLOOR AREA RATIO:** 1.37

**BUILDING AREA:** 4,359 SQUARE FEET

**DENSITY, per DWELLING UNIT:** 1,066 SQUARE FEET PER DWELLING UNIT

**OFF-STREET PARKING:** THE PROPERTY WILL HAVE THREE GARGE PARKING SPACES.

**FRONT SETBACK:** 11 FEET

**REAR SETBACK:** 21 FEET 2 INCHES \*

**SIDE SETBACK:** 3 FEET (east) and 2 FEET (west)

**REAR YARD OPEN SPACE:** 208 SQUARE FEET

**BUILDING HEIGHT:** 37 FEET 8 INCHES

\*Variations will be required.

W. WALTON ST

5/27/2014

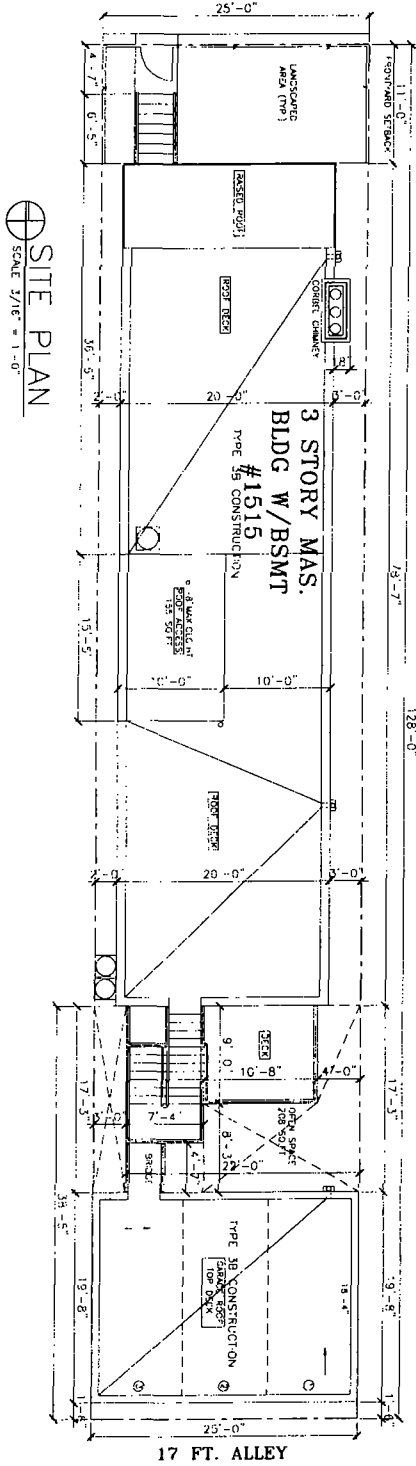

SITE PLAN  
SCALE 1/16" = 1'-0"

© HANNA ARCHITECTS, INC. 2013

<p><b>HANNA</b> ARCHITECTS, INC.</p> <p>180 W. WASHINGTON CHICAGO, ILLINOIS 60602 FAX (312) 754-1801</p> <p>PROFESSIONAL DESIGNER ARCHITECT LICENSE # 0014453</p>	<p><b>OWNER:</b> The Hanna Building Group, LLC 180 W. WASHINGTON CHICAGO, ILLINOIS 60602 FAX (312) 754-1801</p> <p><b>DATE:</b> 05/27/2014</p>	<p><b>CITY:</b> CHICAGO, ILLINOIS</p> <p><b>PROJECT NAME:</b> 1515 W. WALTON ST APART. BLDG #1515</p>	<p><b>PROJECT NAME &amp; ADDRESS:</b> 1515 W. WALTON ST APART. BLDG #1515 CHICAGO, ILLINOIS</p>	<p><b>SHEET TITLE:</b> SITE PLAN &amp; NOTES</p>	<p><b>PLANNING:</b></p>	<p><b>SHEET NUMBER:</b> A-1</p>
---	--	---	---	--	-------------------------	-------------------------------------

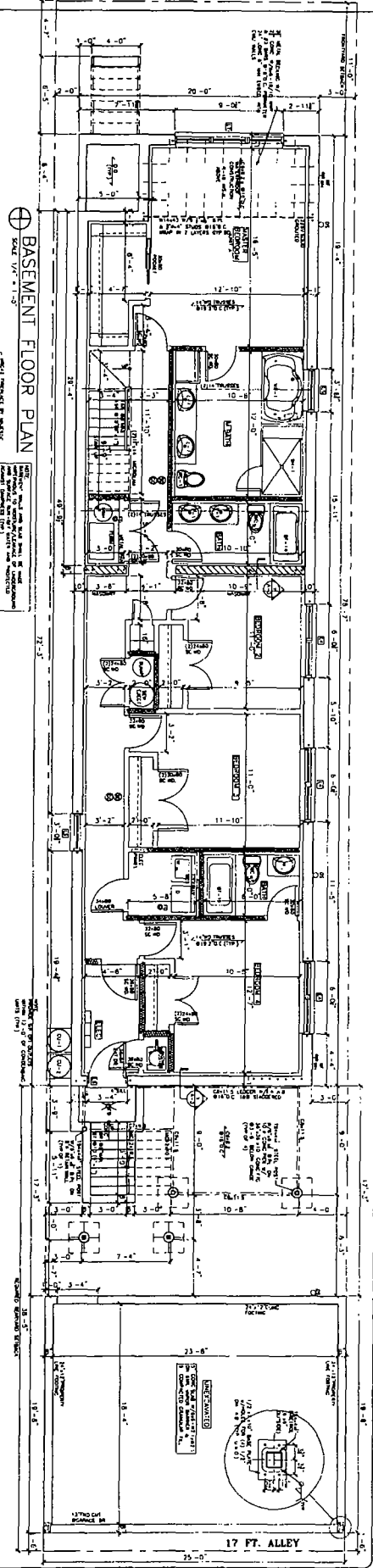

⊕ BASEMENT FLOOR PLAN  
SCALE 1/8" = 1'-0"

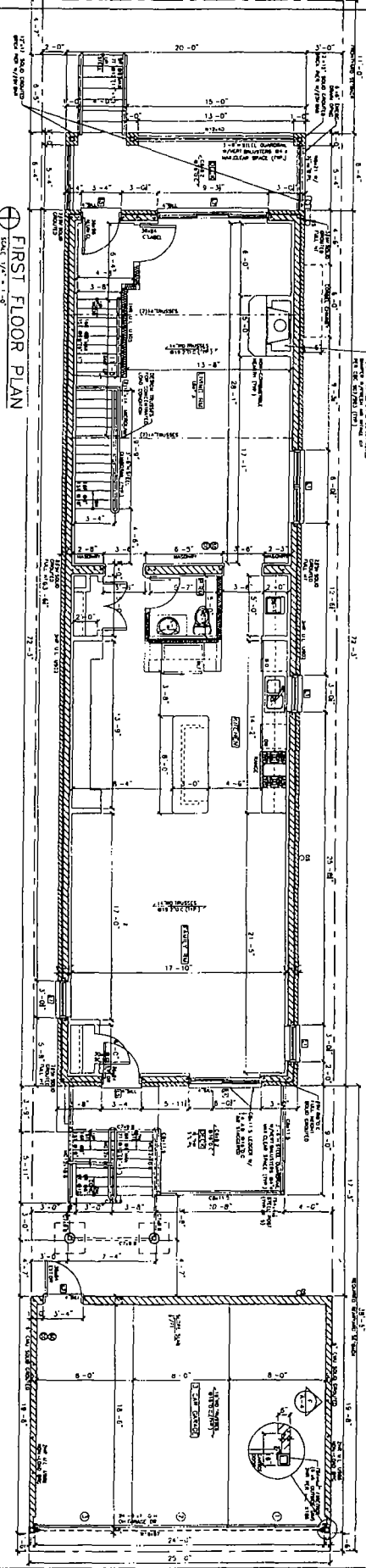

⊕ FIRST FLOOR PLAN  
SCALE 1/8" = 1'-0"

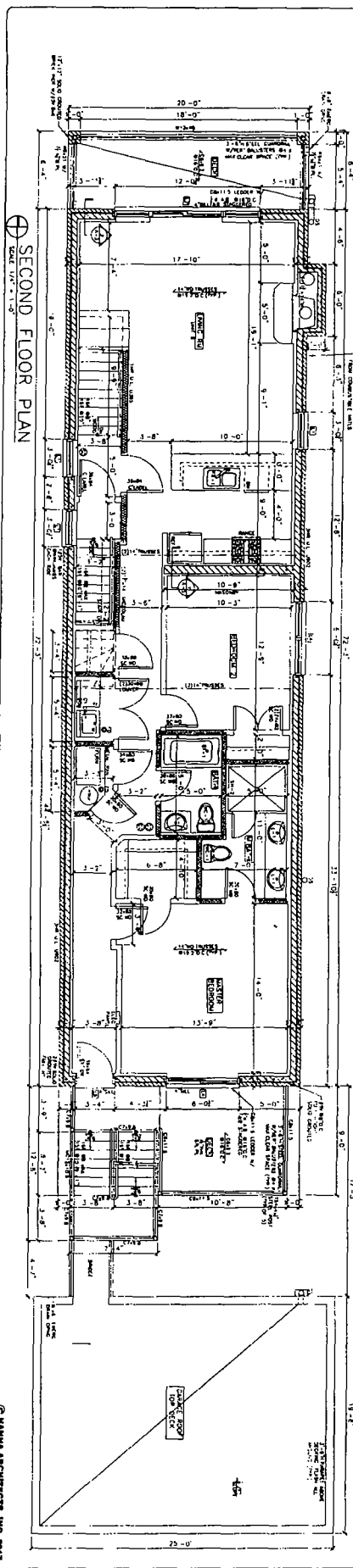

⊕ SECOND FLOOR PLAN  
SCALE 1/8" = 1'-0"

© HANNA ARCHITECTS, INC. 2017

PROJECT NAME & ADDRESS  
1515 N WALTON ST  
1-2 STORY W/RSMT  
APART BLDG W/RSMT  
CHICAGO, ILLINOIS

SHEET TITLE  
BASEMENT THRU  
SECOND FLOOR  
PLAN

SHEET NUMBER  
A-2



DATE OF ISSUE  
ISSUED FOR PERMIT: JAN 23, 2018  
REVISION PER NO.

NOTICE: This plan was prepared by the Architect and is subject to the provisions of the Illinois Professional Land Surveying Act, Chapter 120, Illinois Compiled Statutes (625 ILCS 120/1-120/10). The Surveyor's name and license number shall be shown on this plan.

**HANNA**  
180 W WASHINGTON  
CHICAGO, ILLINOIS 60602  
TEL: (312) 582-1801  
PROFESSIONAL RESIDATION FIRM  
ARCHITECT CORPORATION  
LICENSE NUMBER: 144-001483

**ELECTRICAL SYMBOLS**

- 1 - Two Switch
- 2 - One Switch
- 3 - Double Switch
- 4 - Single Switch
- 5 - Double Switch
- 6 - Single Switch
- 7 - Double Switch
- 8 - Single Switch
- 9 - Double Switch
- 10 - Single Switch
- 11 - Double Switch
- 12 - Single Switch
- 13 - Double Switch
- 14 - Single Switch
- 15 - Double Switch
- 16 - Single Switch
- 17 - Double Switch
- 18 - Single Switch
- 19 - Double Switch
- 20 - Single Switch
- 21 - Double Switch
- 22 - Single Switch
- 23 - Double Switch
- 24 - Single Switch
- 25 - Double Switch
- 26 - Single Switch
- 27 - Double Switch
- 28 - Single Switch
- 29 - Double Switch
- 30 - Single Switch
- 31 - Double Switch
- 32 - Single Switch
- 33 - Double Switch
- 34 - Single Switch
- 35 - Double Switch
- 36 - Single Switch
- 37 - Double Switch
- 38 - Single Switch
- 39 - Double Switch
- 40 - Single Switch
- 41 - Double Switch
- 42 - Single Switch
- 43 - Double Switch
- 44 - Single Switch
- 45 - Double Switch
- 46 - Single Switch
- 47 - Double Switch
- 48 - Single Switch
- 49 - Double Switch
- 50 - Single Switch
- 51 - Double Switch
- 52 - Single Switch
- 53 - Double Switch
- 54 - Single Switch
- 55 - Double Switch
- 56 - Single Switch
- 57 - Double Switch
- 58 - Single Switch
- 59 - Double Switch
- 60 - Single Switch
- 61 - Double Switch
- 62 - Single Switch
- 63 - Double Switch
- 64 - Single Switch
- 65 - Double Switch
- 66 - Single Switch
- 67 - Double Switch
- 68 - Single Switch
- 69 - Double Switch
- 70 - Single Switch
- 71 - Double Switch
- 72 - Single Switch
- 73 - Double Switch
- 74 - Single Switch
- 75 - Double Switch
- 76 - Single Switch
- 77 - Double Switch
- 78 - Single Switch
- 79 - Double Switch
- 80 - Single Switch
- 81 - Double Switch
- 82 - Single Switch
- 83 - Double Switch
- 84 - Single Switch
- 85 - Double Switch
- 86 - Single Switch
- 87 - Double Switch
- 88 - Single Switch
- 89 - Double Switch
- 90 - Single Switch
- 91 - Double Switch
- 92 - Single Switch
- 93 - Double Switch
- 94 - Single Switch
- 95 - Double Switch
- 96 - Single Switch
- 97 - Double Switch
- 98 - Single Switch
- 99 - Double Switch
- 100 - Single Switch

**WALL SYMBOLS**

- 1 - 2" WOOD WALL STUDS @ 16" O.C.
- 2 - 1/2" GYPSUM BOARD (GWB)
- 3 - CONCRETE BLOCK
- 4 - FACE BRICK W/CONCRETE BLOCK
- 5 - SOLO CONCRETE BLOCK
- 6 - FACE BRICK W/CONCRETE BLOCK
- 7 - SOLO CONCRETE BLOCK
- 8 - FACE BRICK W/CONCRETE BLOCK
- 9 - SOLO CONCRETE BLOCK
- 10 - FACE BRICK W/CONCRETE BLOCK
- 11 - SOLO CONCRETE BLOCK
- 12 - FACE BRICK W/CONCRETE BLOCK
- 13 - SOLO CONCRETE BLOCK
- 14 - FACE BRICK W/CONCRETE BLOCK
- 15 - SOLO CONCRETE BLOCK
- 16 - FACE BRICK W/CONCRETE BLOCK
- 17 - SOLO CONCRETE BLOCK
- 18 - FACE BRICK W/CONCRETE BLOCK
- 19 - SOLO CONCRETE BLOCK
- 20 - FACE BRICK W/CONCRETE BLOCK
- 21 - SOLO CONCRETE BLOCK
- 22 - FACE BRICK W/CONCRETE BLOCK
- 23 - SOLO CONCRETE BLOCK
- 24 - FACE BRICK W/CONCRETE BLOCK
- 25 - SOLO CONCRETE BLOCK
- 26 - FACE BRICK W/CONCRETE BLOCK
- 27 - SOLO CONCRETE BLOCK
- 28 - FACE BRICK W/CONCRETE BLOCK
- 29 - SOLO CONCRETE BLOCK
- 30 - FACE BRICK W/CONCRETE BLOCK
- 31 - SOLO CONCRETE BLOCK
- 32 - FACE BRICK W/CONCRETE BLOCK
- 33 - SOLO CONCRETE BLOCK
- 34 - FACE BRICK W/CONCRETE BLOCK
- 35 - SOLO CONCRETE BLOCK
- 36 - FACE BRICK W/CONCRETE BLOCK
- 37 - SOLO CONCRETE BLOCK
- 38 - FACE BRICK W/CONCRETE BLOCK
- 39 - SOLO CONCRETE BLOCK
- 40 - FACE BRICK W/CONCRETE BLOCK
- 41 - SOLO CONCRETE BLOCK
- 42 - FACE BRICK W/CONCRETE BLOCK
- 43 - SOLO CONCRETE BLOCK
- 44 - FACE BRICK W/CONCRETE BLOCK
- 45 - SOLO CONCRETE BLOCK
- 46 - FACE BRICK W/CONCRETE BLOCK
- 47 - SOLO CONCRETE BLOCK
- 48 - FACE BRICK W/CONCRETE BLOCK
- 49 - SOLO CONCRETE BLOCK
- 50 - FACE BRICK W/CONCRETE BLOCK
- 51 - SOLO CONCRETE BLOCK
- 52 - FACE BRICK W/CONCRETE BLOCK
- 53 - SOLO CONCRETE BLOCK
- 54 - FACE BRICK W/CONCRETE BLOCK
- 55 - SOLO CONCRETE BLOCK
- 56 - FACE BRICK W/CONCRETE BLOCK
- 57 - SOLO CONCRETE BLOCK
- 58 - FACE BRICK W/CONCRETE BLOCK
- 59 - SOLO CONCRETE BLOCK
- 60 - FACE BRICK W/CONCRETE BLOCK
- 61 - SOLO CONCRETE BLOCK
- 62 - FACE BRICK W/CONCRETE BLOCK
- 63 - SOLO CONCRETE BLOCK
- 64 - FACE BRICK W/CONCRETE BLOCK
- 65 - SOLO CONCRETE BLOCK
- 66 - FACE BRICK W/CONCRETE BLOCK
- 67 - SOLO CONCRETE BLOCK
- 68 - FACE BRICK W/CONCRETE BLOCK
- 69 - SOLO CONCRETE BLOCK
- 70 - FACE BRICK W/CONCRETE BLOCK
- 71 - SOLO CONCRETE BLOCK
- 72 - FACE BRICK W/CONCRETE BLOCK
- 73 - SOLO CONCRETE BLOCK
- 74 - FACE BRICK W/CONCRETE BLOCK
- 75 - SOLO CONCRETE BLOCK
- 76 - FACE BRICK W/CONCRETE BLOCK
- 77 - SOLO CONCRETE BLOCK
- 78 - FACE BRICK W/CONCRETE BLOCK
- 79 - SOLO CONCRETE BLOCK
- 80 - FACE BRICK W/CONCRETE BLOCK
- 81 - SOLO CONCRETE BLOCK
- 82 - FACE BRICK W/CONCRETE BLOCK
- 83 - SOLO CONCRETE BLOCK
- 84 - FACE BRICK W/CONCRETE BLOCK
- 85 - SOLO CONCRETE BLOCK
- 86 - FACE BRICK W/CONCRETE BLOCK
- 87 - SOLO CONCRETE BLOCK
- 88 - FACE BRICK W/CONCRETE BLOCK
- 89 - SOLO CONCRETE BLOCK
- 90 - FACE BRICK W/CONCRETE BLOCK
- 91 - SOLO CONCRETE BLOCK
- 92 - FACE BRICK W/CONCRETE BLOCK
- 93 - SOLO CONCRETE BLOCK
- 94 - FACE BRICK W/CONCRETE BLOCK
- 95 - SOLO CONCRETE BLOCK
- 96 - FACE BRICK W/CONCRETE BLOCK
- 97 - SOLO CONCRETE BLOCK
- 98 - FACE BRICK W/CONCRETE BLOCK
- 99 - SOLO CONCRETE BLOCK
- 100 - FACE BRICK W/CONCRETE BLOCK

**UNIT SCHEDULE**

NO.	DESCRIPTION	QTY.	UNIT
1	1/2" GYPSUM BOARD (GWB)	1000	SQ. FT.
2	CONCRETE BLOCK	1000	SQ. FT.
3	FACE BRICK W/CONCRETE BLOCK	1000	SQ. FT.
4	SOLO CONCRETE BLOCK	1000	SQ. FT.
5	FACE BRICK W/CONCRETE BLOCK	1000	SQ. FT.
6	SOLO CONCRETE BLOCK	1000	SQ. FT.
7	FACE BRICK W/CONCRETE BLOCK	1000	SQ. FT.
8	SOLO CONCRETE BLOCK	1000	SQ. FT.
9	FACE BRICK W/CONCRETE BLOCK	1000	SQ. FT.
10	SOLO CONCRETE BLOCK	1000	SQ. FT.
11	FACE BRICK W/CONCRETE BLOCK	1000	SQ. FT.
12	SOLO CONCRETE BLOCK	1000	SQ. FT.
13	FACE BRICK W/CONCRETE BLOCK	1000	SQ. FT.
14	SOLO CONCRETE BLOCK	1000	SQ. FT.
15	FACE BRICK W/CONCRETE BLOCK	1000	SQ. FT.
16	SOLO CONCRETE BLOCK	1000	SQ. FT.
17	FACE BRICK W/CONCRETE BLOCK	1000	SQ. FT.
18	SOLO CONCRETE BLOCK	1000	SQ. FT.
19	FACE BRICK W/CONCRETE BLOCK	1000	SQ. FT.
20	SOLO CONCRETE BLOCK	1000	SQ. FT.
21	FACE BRICK W/CONCRETE BLOCK	1000	SQ. FT.
22	SOLO CONCRETE BLOCK	1000	SQ. FT.
23	FACE BRICK W/CONCRETE BLOCK	1000	SQ. FT.
24	SOLO CONCRETE BLOCK	1000	SQ. FT.
25	FACE BRICK W/CONCRETE BLOCK	1000	SQ. FT.
26	SOLO CONCRETE BLOCK	1000	SQ. FT.
27	FACE BRICK W/CONCRETE BLOCK	1000	SQ. FT.
28	SOLO CONCRETE BLOCK	1000	SQ. FT.
29	FACE BRICK W/CONCRETE BLOCK	1000	SQ. FT.
30	SOLO CONCRETE BLOCK	1000	SQ. FT.
31	FACE BRICK W/CONCRETE BLOCK	1000	SQ. FT.
32	SOLO CONCRETE BLOCK	1000	SQ. FT.
33	FACE BRICK W/CONCRETE BLOCK	1000	SQ. FT.
34	SOLO CONCRETE BLOCK	1000	SQ. FT.
35	FACE BRICK W/CONCRETE BLOCK	1000	SQ. FT.
36	SOLO CONCRETE BLOCK	1000	SQ. FT.
37	FACE BRICK W/CONCRETE BLOCK	1000	SQ. FT.
38	SOLO CONCRETE BLOCK	1000	SQ. FT.
39	FACE BRICK W/CONCRETE BLOCK	1000	SQ. FT.
40	SOLO CONCRETE BLOCK	1000	SQ. FT.
41	FACE BRICK W/CONCRETE BLOCK	1000	SQ. FT.
42	SOLO CONCRETE BLOCK	1000	SQ. FT.
43	FACE BRICK W/CONCRETE BLOCK	1000	SQ. FT.
44	SOLO CONCRETE BLOCK	1000	SQ. FT.
45	FACE BRICK W/CONCRETE BLOCK	1000	SQ. FT.
46	SOLO CONCRETE BLOCK	1000	SQ. FT.
47	FACE BRICK W/CONCRETE BLOCK	1000	SQ. FT.
48	SOLO CONCRETE BLOCK	1000	SQ. FT.
49	FACE BRICK W/CONCRETE BLOCK	1000	SQ. FT.
50	SOLO CONCRETE BLOCK	1000	SQ. FT.

**NOTES**

1. ALL WORK SHALL BE IN ACCORDANCE WITH THE SPECIFICATIONS AND CONDITIONS OF CONTRACT.
2. ALL WORK SHALL BE DONE IN ACCORDANCE WITH THE LATEST EDITIONS OF THE BUILDING CODES AND REGULATIONS.
3. ALL WORK SHALL BE DONE IN ACCORDANCE WITH THE LATEST EDITIONS OF THE NATIONAL ELECTRICAL CODE AND THE NATIONAL FIRE ALARM AND SIGNALING CODE.
4. ALL WORK SHALL BE DONE IN ACCORDANCE WITH THE LATEST EDITIONS OF THE INTERNATIONAL MECHANICAL AND PLUMBING CODES.
5. ALL WORK SHALL BE DONE IN ACCORDANCE WITH THE LATEST EDITIONS OF THE INTERNATIONAL ROOFING AND FLOORING CODES.
6. ALL WORK SHALL BE DONE IN ACCORDANCE WITH THE LATEST EDITIONS OF THE INTERNATIONAL BUILDING CODES.
7. ALL WORK SHALL BE DONE IN ACCORDANCE WITH THE LATEST EDITIONS OF THE INTERNATIONAL PLUMBING AND MECHANICAL CODES.
8. ALL WORK SHALL BE DONE IN ACCORDANCE WITH THE LATEST EDITIONS OF THE INTERNATIONAL FIRE AND SAFETY CODES.
9. ALL WORK SHALL BE DONE IN ACCORDANCE WITH THE LATEST EDITIONS OF THE INTERNATIONAL HEALTH AND SAFETY CODES.
10. ALL WORK SHALL BE DONE IN ACCORDANCE WITH THE LATEST EDITIONS OF THE INTERNATIONAL ENVIRONMENTAL AND ENERGY CODES.
11. ALL WORK SHALL BE DONE IN ACCORDANCE WITH THE LATEST EDITIONS OF THE INTERNATIONAL TRANSPORTATION AND TRAVEL CODES.
12. ALL WORK SHALL BE DONE IN ACCORDANCE WITH THE LATEST EDITIONS OF THE INTERNATIONAL COMMUNICATIONS CODES.
13. ALL WORK SHALL BE DONE IN ACCORDANCE WITH THE LATEST EDITIONS OF THE INTERNATIONAL INFRASTRUCTURE CODES.
14. ALL WORK SHALL BE DONE IN ACCORDANCE WITH THE LATEST EDITIONS OF THE INTERNATIONAL WATER AND WASTE CODES.
15. ALL WORK SHALL BE DONE IN ACCORDANCE WITH THE LATEST EDITIONS OF THE INTERNATIONAL POWER AND ENERGY CODES.
16. ALL WORK SHALL BE DONE IN ACCORDANCE WITH THE LATEST EDITIONS OF THE INTERNATIONAL TELECOMMUNICATIONS CODES.
17. ALL WORK SHALL BE DONE IN ACCORDANCE WITH THE LATEST EDITIONS OF THE INTERNATIONAL AEROSPACE AND NAVIGATION CODES.
18. ALL WORK SHALL BE DONE IN ACCORDANCE WITH THE LATEST EDITIONS OF THE INTERNATIONAL MARITIME CODES.
19. ALL WORK SHALL BE DONE IN ACCORDANCE WITH THE LATEST EDITIONS OF THE INTERNATIONAL SPACE AND AEROSPACE CODES.
20. ALL WORK SHALL BE DONE IN ACCORDANCE WITH THE LATEST EDITIONS OF THE INTERNATIONAL POLICE AND SECURITY CODES.
21. ALL WORK SHALL BE DONE IN ACCORDANCE WITH THE LATEST EDITIONS OF THE INTERNATIONAL JUDICIAL AND LEGAL CODES.
22. ALL WORK SHALL BE DONE IN ACCORDANCE WITH THE LATEST EDITIONS OF THE INTERNATIONAL EDUCATION AND RESEARCH CODES.
23. ALL WORK SHALL BE DONE IN ACCORDANCE WITH THE LATEST EDITIONS OF THE INTERNATIONAL CULTURAL AND HERITAGE CODES.
24. ALL WORK SHALL BE DONE IN ACCORDANCE WITH THE LATEST EDITIONS OF THE INTERNATIONAL ENVIRONMENTAL AND NATURAL RESOURCES CODES.
25. ALL WORK SHALL BE DONE IN ACCORDANCE WITH THE LATEST EDITIONS OF THE INTERNATIONAL SCIENCE AND TECHNOLOGY CODES.
26. ALL WORK SHALL BE DONE IN ACCORDANCE WITH THE LATEST EDITIONS OF THE INTERNATIONAL ARTS AND CULTURE CODES.
27. ALL WORK SHALL BE DONE IN ACCORDANCE WITH THE LATEST EDITIONS OF THE INTERNATIONAL SPORTS AND RECREATION CODES.
28. ALL WORK SHALL BE DONE IN ACCORDANCE WITH THE LATEST EDITIONS OF THE INTERNATIONAL TOURISM AND TRAVEL CODES.
29. ALL WORK SHALL BE DONE IN ACCORDANCE WITH THE LATEST EDITIONS OF THE INTERNATIONAL TRANSPORTATION AND TRAVEL CODES.
30. ALL WORK SHALL BE DONE IN ACCORDANCE WITH THE LATEST EDITIONS OF THE INTERNATIONAL INFRASTRUCTURE CODES.
31. ALL WORK SHALL BE DONE IN ACCORDANCE WITH THE LATEST EDITIONS OF THE INTERNATIONAL COMMUNICATIONS CODES.
32. ALL WORK SHALL BE DONE IN ACCORDANCE WITH THE LATEST EDITIONS OF THE INTERNATIONAL INFRASTRUCTURE CODES.
33. ALL WORK SHALL BE DONE IN ACCORDANCE WITH THE LATEST EDITIONS OF THE INTERNATIONAL COMMUNICATIONS CODES.
34. ALL WORK SHALL BE DONE IN ACCORDANCE WITH THE LATEST EDITIONS OF THE INTERNATIONAL INFRASTRUCTURE CODES.
35. ALL WORK SHALL BE DONE IN ACCORDANCE WITH THE LATEST EDITIONS OF THE INTERNATIONAL COMMUNICATIONS CODES.
36. ALL WORK SHALL BE DONE IN ACCORDANCE WITH THE LATEST EDITIONS OF THE INTERNATIONAL INFRASTRUCTURE CODES.
37. ALL WORK SHALL BE DONE IN ACCORDANCE WITH THE LATEST EDITIONS OF THE INTERNATIONAL COMMUNICATIONS CODES.
38. ALL WORK SHALL BE DONE IN ACCORDANCE WITH THE LATEST EDITIONS OF THE INTERNATIONAL INFRASTRUCTURE CODES.
39. ALL WORK SHALL BE DONE IN ACCORDANCE WITH THE LATEST EDITIONS OF THE INTERNATIONAL COMMUNICATIONS CODES.
40. ALL WORK SHALL BE DONE IN ACCORDANCE WITH THE LATEST EDITIONS OF THE INTERNATIONAL INFRASTRUCTURE CODES.
41. ALL WORK SHALL BE DONE IN ACCORDANCE WITH THE LATEST EDITIONS OF THE INTERNATIONAL COMMUNICATIONS CODES.
42. ALL WORK SHALL BE DONE IN ACCORDANCE WITH THE LATEST EDITIONS OF THE INTERNATIONAL INFRASTRUCTURE CODES.
43. ALL WORK SHALL BE DONE IN ACCORDANCE WITH THE LATEST EDITIONS OF THE INTERNATIONAL COMMUNICATIONS CODES.
44. ALL WORK SHALL BE DONE IN ACCORDANCE WITH THE LATEST EDITIONS OF THE INTERNATIONAL INFRASTRUCTURE CODES.
45. ALL WORK SHALL BE DONE IN ACCORDANCE WITH THE LATEST EDITIONS OF THE INTERNATIONAL COMMUNICATIONS CODES.
46. ALL WORK SHALL BE DONE IN ACCORDANCE WITH THE LATEST EDITIONS OF THE INTERNATIONAL INFRASTRUCTURE CODES.
47. ALL WORK SHALL BE DONE IN ACCORDANCE WITH THE LATEST EDITIONS OF THE INTERNATIONAL COMMUNICATIONS CODES.
48. ALL WORK SHALL BE DONE IN ACCORDANCE WITH THE LATEST EDITIONS OF THE INTERNATIONAL INFRASTRUCTURE CODES.
49. ALL WORK SHALL BE DONE IN ACCORDANCE WITH THE LATEST EDITIONS OF THE INTERNATIONAL COMMUNICATIONS CODES.
50. ALL WORK SHALL BE DONE IN ACCORDANCE WITH THE LATEST EDITIONS OF THE INTERNATIONAL INFRASTRUCTURE CODES.

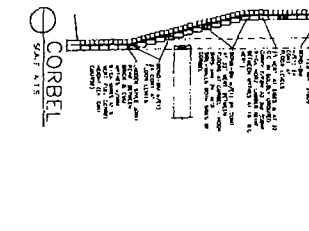
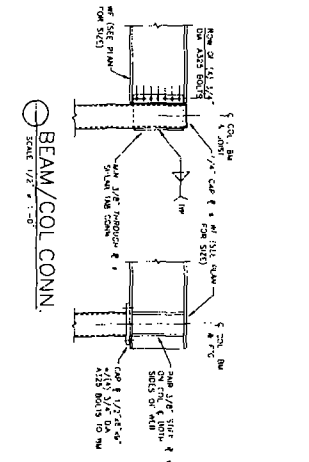
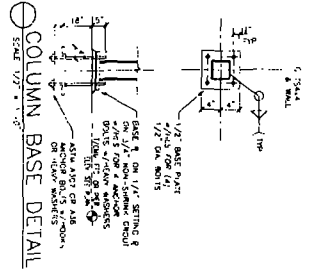
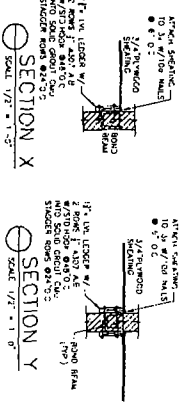
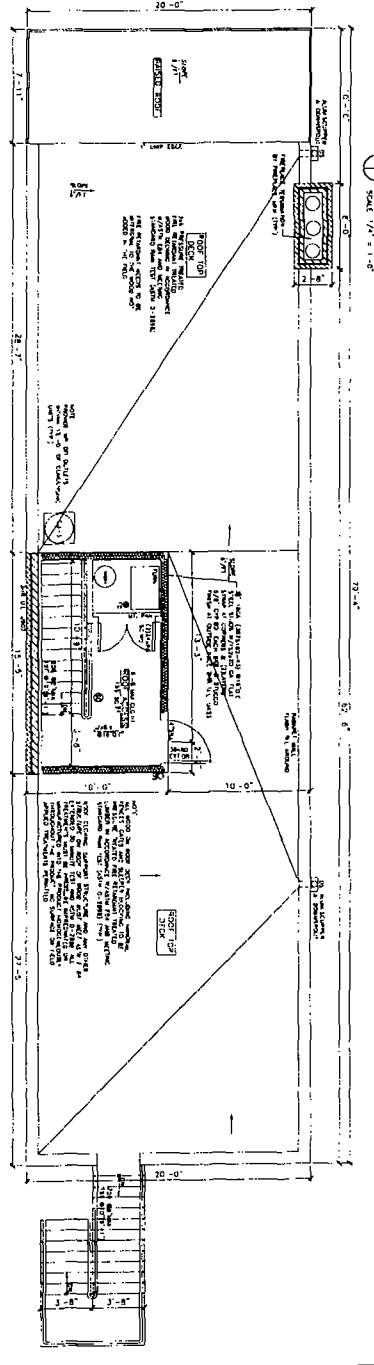
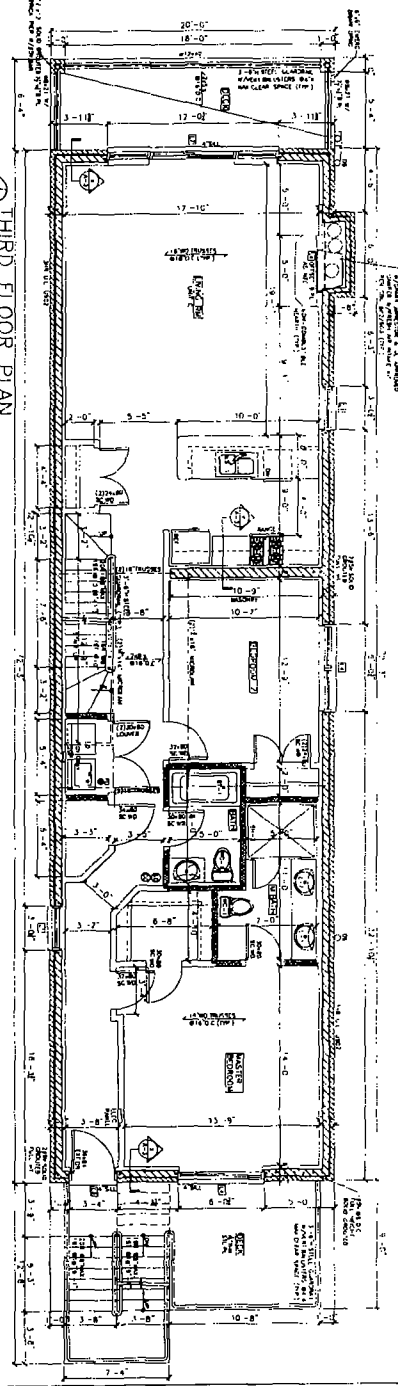

MANNA ARCHITECTS, INC. 8017

SHEET NUMBER A-3

FILENAME

SHEET TITLE  
THIRD FLOOR & ROOF DECK FLOOR PLAN

PROJECT NAME & ADDRESS  
1515 W. WALTON ST  
3 STORY 3 UNIT  
APART BLDG W/BSMT  
CHICAGO, ILLINOIS



DESIGNED BY: JOHN C. HANNA  
CHECKED BY: JOHN C. HANNA  
DATE: 08/15/17

DATE: 08/15/17  
PROJECT: 1515 W. WALTON ST  
SHEET: A-3

**MANNA**  
180 W WASHINGTON  
CHICAGO, IL 60601  
PROFESSIONAL DESIGN FIRM  
LICENSE NUMBER: 001-09733

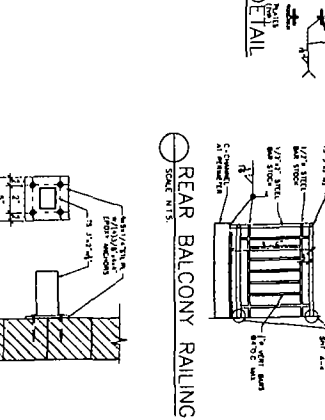
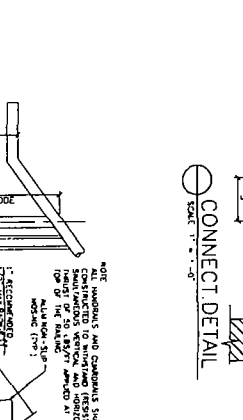
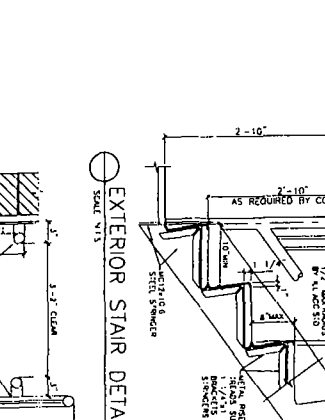
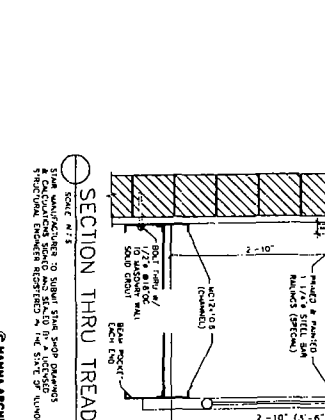
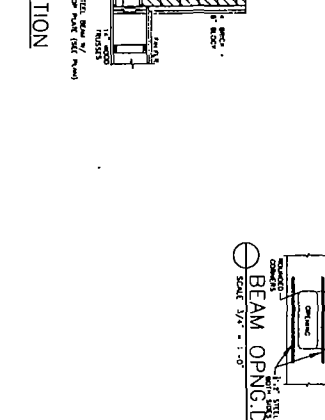
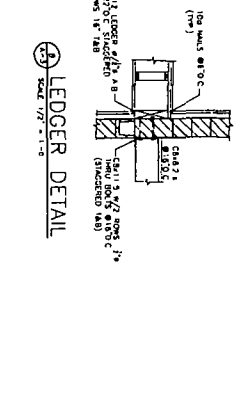
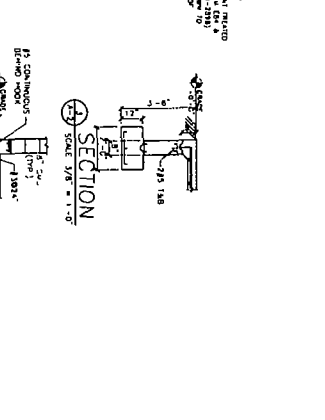
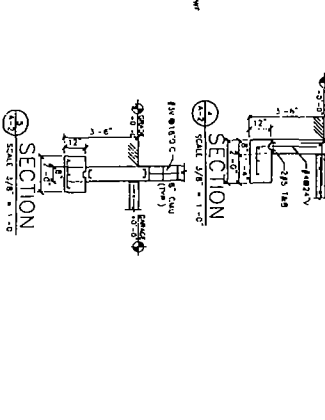
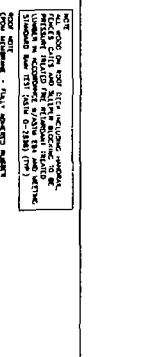
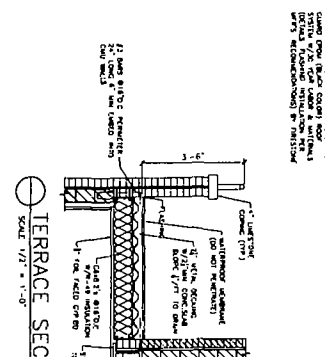
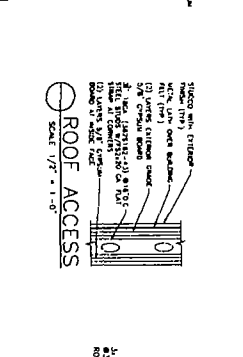
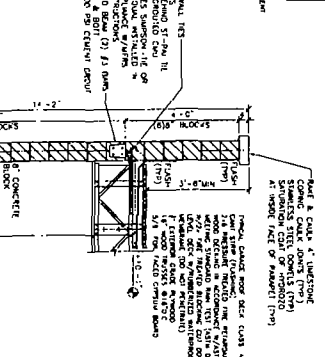
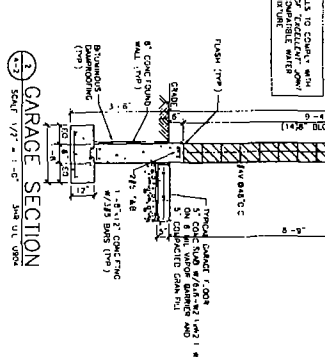
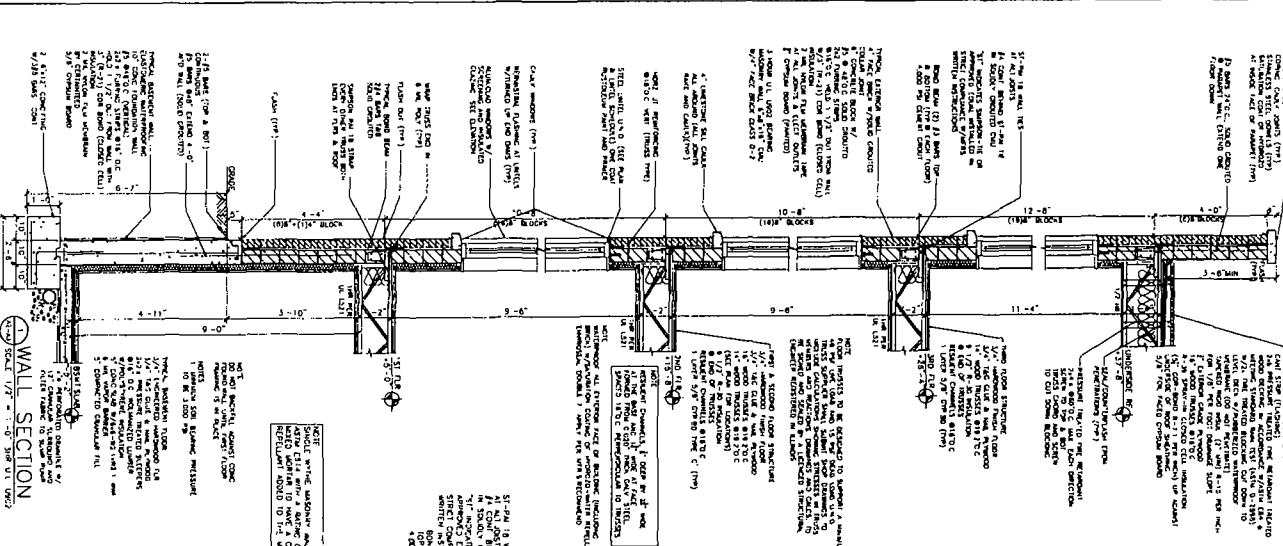

**PROJECT NAME & ADDRESS**  
 1515 W. WALTON ST.  
 3 STORY 3 UNIT  
 APART BLDG W/BSMT  
 CHICAGO, ILLINOIS

**DATE**  
 10/1/11

**SCALE**  
 1/2" = 1'-0"

**PROJECT NUMBER**  
 101483

**PROFESSIONAL DESIGN FIRM**  
 HANNA ARCHITECTS, INC. 2017

**PROFESSIONAL DESIGNER**  
 JOHN HANNA  
 LICENSE NUMBER 141-101483

**PROJECT TITLE**  
 WALL SECTION & DETAILS

**SHEET NUMBER**  
 A-4





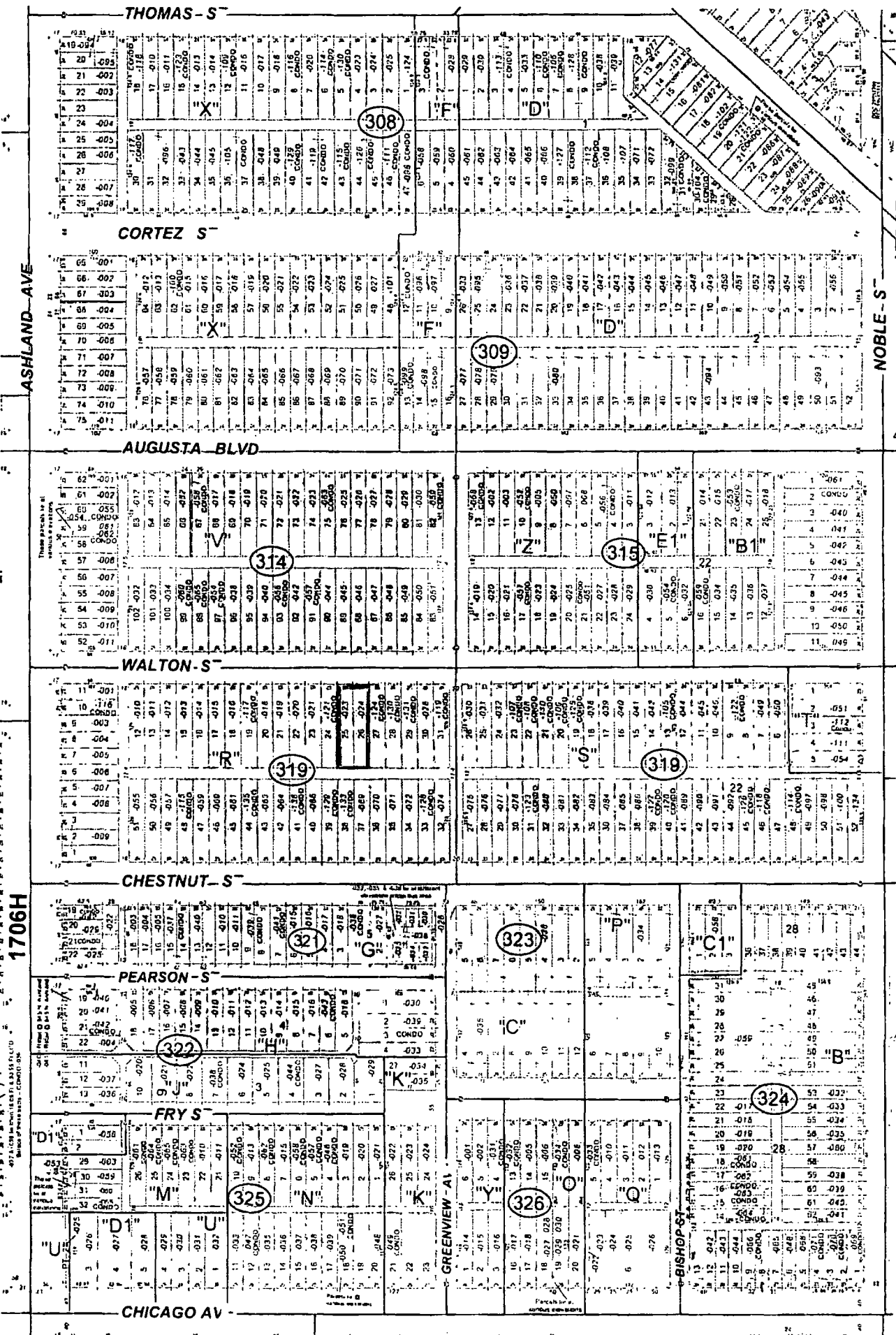

ASHLAND AVE

1706H

THOMAS S

CORTEZ S

AUGUSTA BLVD

WALTON S

CHESTNUT S

PEARSON S

FRY S

CHICAGO AV

GREENVIEW AV

BISHOP ST

NOBLE S

308

309

314

319

319

323

322

324

325

326

WRITTEN NOTICE AFFIDAVIT  
(Section 17-13-0107)

August 30, 2017

Honorable Daniel Solis  
Chairman, Committee on Zoning  
121 North LaSalle Street  
Room 304, City Hall  
Chicago, Illinois 60602

The undersigned, **Daniel G. Lauer**, being first duly sworn on oath, deposes and states the following:

The undersigned certifies that he has complied with the requirements of Section 17-13-0107 of the Chicago Zoning Ordinance, by sending written notice to such property owners who appear to be the owners of the property within the subject area not solely owned by the applicant, and to the owners of all property within 250 feet in each direction of the lot line of the subject property, exclusive of public roads, streets, alleys and other public ways, or a total distance limited to 400 feet. Said "written notice" was sent by First Class U.S. Mail, no more than 30 days before filing the application.

The undersigned certifies that the notice contained the address of the property sought to be rezoned; a statement of the intended use of the property; the name and address of the applicant; the name and address of the owner; and a statement that the applicant intends to file the application for a change in zoning on or about approximately August 30, 2017.

The undersigned certifies that the applicant has made a bona fide effort to determine the addresses of the parties to be notified under Section 17-13-0107 of the Chicago Zoning Ordinance, and that the accompanying list of names and addresses of surrounding property owners within 250 feet of the subject site is a complete list containing the names and addresses of the people required to be served.



\_\_\_\_\_  
Daniel G. Lauer

Subscribed and Sworn to  
Before me this 30 day of  
August, 2017.

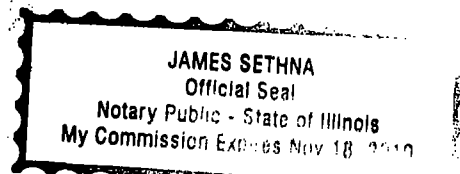
  
\_\_\_\_\_  
Notary Public

LAW OFFICES

DANIEL G. LAUER & ASSOCIATES, P.C.

1424 WEST DIVISION STREET  
CHICAGO, ILLINOIS 60642

TELEPHONE (773) 862-7200  
FACSIMILE (773) 862-0600

DANIEL G. LAUER

JAMES R. SETHNA

OF COUNSEL

ROBERT C. STOLLER  
HERBERT V. HEDEEN

August 30, 2017

Re: Zoning Change for 1515 West Walton Street

Dear Property Owner:

In accordance with the requirements for an Amendment to the Chicago Zoning Ordinance, please be informed that on or about August 30, 2017, the undersigned will file an application for a change in zoning from RS-3 Residential Single-Unit (Detached House) District to RM-4.5 Residential Multi-Unit District for the property located at 1515 West Walton Street, Chicago, Illinois.

This zoning change is for purposes to allow Applicant to construct a three-story, three dwelling unit building with a basement. There will be a three car garage at the rear of the property. The footprint of the building shall be approximately be 20 feet by 78 feet 7 inches in size. The building height shall be 37 feet 8 inches high, as defined by code.

The Applicant is EZMB, LLC which is located at 1416 N. Western Ave., Chicago, Illinois 60622. Owners of the Property is Cirilo Garcia a/k/a Cirilo Garcia Camacho and Vincenta Hernandez Garcia who both reside at 1515 West Walton Street, Chicago, Illinois 60642. The contact person for this application is Daniel G. Lauer, 1424 West Division Street, Chicago, Illinois 60642, and (773) 862-7200.

Please note that the Applicant is not seeking to rezone or purchase your property. The Applicant is required by law to send this notice because you own property within 250 feet of the property to be rezoned.

Very truly yours,



Daniel G. Lauer

**AUTHORIZATION TO  
PROCEED WITH ZONING CHANGE APPLICATION**

Cirilo Garcia a/k/a Cirilo Garcia Camacho and Vincenta Hernandez Garcia, as record title holder of the Property located at **1515 West Walton St., Chicago, Illinois**. PIN number:

**17-05-319-023-0000**

hereby authorizes the Contract Purchaser of the above Property, **EZMB, LLC** to proceed with and to take all steps necessary in applying for a Zoning Change Application with the City of Chicago Department of Zoning to change the zoning district to RM-1.5 Residential Multi-Unit District for the construction of a three (3) residential dwelling unit building with basement.

*Cirilo Garcia Camacho*  
Cirilo Garcia a/k/a Cirilo Garcia Camacho

*Vinenta Hernandez Garcia*  
Vincenta Hernandez Garcia

Dated: August 22, 2017

#19350 TI  
INTRO. DATE:  
SEPT. 6, 2017

CITY OF CHICAGO

APPLICATION FOR AN AMENDMENT TO  
THE CHICAGO ZONING ORDINANCE

1. ADDRESS of the property Applicant is seeking to rezone:

1515 West Walton Street

2. Ward Number that property is located in: 1st Ward

3. APPLICANT EZMB, LLC

ADDRESS 1416 N. Western Ave CITY Chicago

STATE IL ZIP CODE 60622 PHONE (773) 489-3000

EMAIL n/a CONTACT PERSON Zdzislaw Banys

4. Is the applicant the owner of the property? YES \_\_\_\_\_ NO X  
If the applicant is not the owner of the property, please provide the following information regarding the owner and attach written authorization from the owner allowing the application to proceed.

OWNER Cirilo Garcia a/k/a Cirilo Garcia Camacho and Vincenta Hernandez Garcia

ADDRESS 1515 W. Walton St. CITY Chicago

STATE IL ZIP CODE 60642 PHONE (773) 772-8989

EMAIL N/a CONTACT PERSON Michael A. Perez, Esq.

5. If the Applicant/Owner of the property has obtained a lawyer as their representative for the rezoning, please provide the following information:

ATTORNEY DANIEL G. LAUER, ESQ.

ADDRESS 1424 WEST DIVISION STREET

CITY CHICAGO STATE IL ZIP CODE 60642

PHONE (773) 862-7200 FAX (773) 862-0600 EMAIL dan@dglpc.com

6. If the applicant is a legal entity (Corporation, LLC, Partnership, etc.) please provide the names of all owners as disclosed on the Economic Disclosure Statements.

Zdzislaw Banys  
\_\_\_\_\_  
\_\_\_\_\_  
\_\_\_\_\_  
\_\_\_\_\_

7. On what date did the owner acquire legal title to the subject property? February 23, 2006

8. Has the present owner previously rezoned this property? If yes, when?  
NO.  
\_\_\_\_\_

9. Present Zoning District RS-3 Proposed Zoning District RM-4.5

10. Lot size in square feet (or dimensions) 3,200 square feet

11. Current Use of the property 2-Story Frame Building

12. Reason for rezoning the property TO CONSTRUCT A 3-STORY, THREE DWELLING UNIT BUILDING WITH A BASEMENT.  
\_\_\_\_\_

13. Describe the proposed use of the property after the rezoning. Indicate the number of dwelling units; number of parking spaces; approximate square footage of any commercial space; and height of the proposed building. (BE SPECIFIC)  
THE APPLICANT INTENDS TO CONSTRUCT A 3-STORY, THREE DWELLING UNIT BUILDING WITH A BASEMENT. THERE WILL BE A THREE (3) CAR GARAGE AT THE REAR OF THE PROPERTY. THE

FOOTPRINT OF THE BUILDING SHALL BE APPROXIMATELY 20 FEET BY 78 FEET 7 INCHES IN SIZE. THE BUILDING HEIGHT SHALL BE 37 FEET 8 INCHES HIGH, AS DEFINED BY CODE.

14. The Affordable Requirements Ordinance (ARO) requires on-site affordable housing units and/or a financial contribution for residential housing projects with ten or more units that receive a zoning change which, among other triggers, increases the allowable floor area, or, for existing Planned Developments, increases the number of units (see attached fact sheet or visit [www.cityofchicago.org/ARO](http://www.cityofchicago.org/ARO) for more information). Is this project subject to the ARO?

YES \_\_\_\_\_ NO X \_\_\_\_\_

COUNTY OF COOK  
STATE OF ILLINOIS

EZMB, LLC, being first duly sworn on oath, states that all of the above statements and the statements contained in the documents submitted herewith are true and correct.

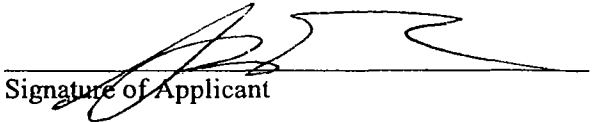
  
Signature of Applicant

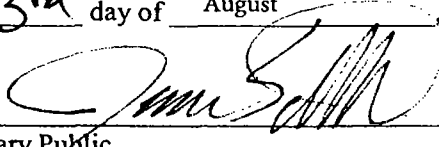
Subscribed and Sworn to before me this  
23<sup>rd</sup> day of August, 2017.  
  
Notary Public

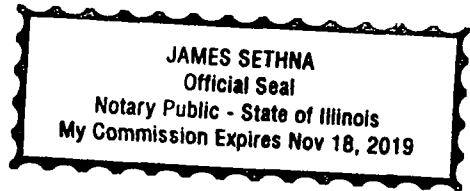

For Office Use Only

Date of Introduction: \_\_\_\_\_

File Number: \_\_\_\_\_

Ward: \_\_\_\_\_

**CITY OF CHICAGO  
ECONOMIC DISCLOSURE STATEMENT  
AND AFFIDAVIT**

**SECTION I -- GENERAL INFORMATION**

A. Legal name of the Disclosing Party submitting this EDS. Include d/b/a/ if applicable:

EZMB, LLC

**Check ONE of the following three boxes:**

Indicate whether the Disclosing Party submitting this EDS is:

1.  the Applicant

OR

2.  a legal entity currently holding, or anticipated to hold within six months after City action on the contract, transaction or other undertaking to which this EDS pertains (referred to below as the "Matter"), a direct or indirect interest in excess of 7.5% in the Applicant. State the Applicant's legal name: \_\_\_\_\_

OR

3.  a legal entity with a direct or indirect right of control of the Applicant (see Section II(B)(1)) State the legal name of the entity in which the Disclosing Party holds a right of control: \_\_\_\_\_

B. Business address of the Disclosing Party: 1416 N. Western Ave.  
Chicago, IL 60642

C. Telephone: (773) 489-3000 Fax: n/a Email: n/a

D. Name of contact person: Zdzislaw Banyś

E. Federal Employer Identification No. (if you have one): Not Applicable

F. Brief description of the Matter to which this EDS pertains. (Include project number and location of property, if applicable):

ZONING CHANGE OF 1515 WEST WALTON ST., CHICAGO, ILLINOIS

G. Which City agency or department is requesting this EDS? DEPARTMENT OF PLANNING AND DEVELOPMENT

If the Matter is a contract being handled by the City's Department of Procurement Services, please complete the following:

Specification # \_\_\_\_\_ and Contract # \_\_\_\_\_



**SECTION II -- DISCLOSURE OF OWNERSHIP INTERESTS**

**A. NATURE OF THE DISCLOSING PARTY**

1. Indicate the nature of the Disclosing Party:

- |   |   |
|---|---|
| <input type="checkbox"/> Person                                   | <input checked="" type="checkbox"/> Limited liability company |
| <input type="checkbox"/> Publicly registered business corporation | <input type="checkbox"/> Limited liability partnership        |
| <input type="checkbox"/> Privately held business corporation      | <input type="checkbox"/> Joint venture                        |
| <input type="checkbox"/> Sole proprietorship                      | <input type="checkbox"/> Not-for-profit corporation           |
| <input type="checkbox"/> General partnership                      | (Is the not-for-profit corporation also a 501(c)(3))?         |
| <input type="checkbox"/> Limited partnership                      | <input type="checkbox"/> Yes <input type="checkbox"/> No      |
| <input type="checkbox"/> Trust                                    | <input type="checkbox"/> Other (please specify)               |
- 

2. For legal entities, the state (or foreign country) of incorporation or organization, if applicable:

Illinois

---

3. For legal entities not organized in the State of Illinois: Has the organization registered to do business in the State of Illinois as a foreign entity?

- Yes                       No                       Organized in Illinois

**B. IF THE DISCLOSING PARTY IS A LEGAL ENTITY:**

1. List below the full names and titles, if applicable, of: (i) all executive officers and all directors of the entity; (ii) **for not-for-profit corporations**, all members, if any, which are legal entities (if there are no such members, write "no members which are legal entities"); (iii) **for trusts, estates or other similar entities**, the trustee, executor, administrator, or similarly situated party; (iv) **for general or limited partnerships, limited liability companies, limited liability partnerships or joint ventures**, each general partner, managing member, manager or any other person or legal entity that directly or indirectly controls the day-to-day management of the Applicant.

**NOTE:** Each legal entity listed below must submit an EDS on its own behalf.

Name	Title
Zdzislaw Banys	Manager

---

---

2. Please provide the following information concerning each person or legal entity having a direct or indirect, current or prospective (i.e. within 6 months after City action) beneficial interest (including ownership) in excess of 7.5% of the Applicant. Examples of such an interest include shares in a corporation, partnership interest in a partnership or joint venture, interest of a member or manager in a



Name (indicate whether retained or anticipated to be retained)	Business Address	Relationship to Disclosing Party (subcontractor, attorney, lobbyist, etc.)	Fees (indicate whether paid or estimated.) NOTE: "hourly rate" or "t.b.d." is not an acceptable response. ESTIMATED FEE OF \$5,000.00
DANIEL G. LAUER, ESQ.	1424 W. DIVISION ST., CHGO, IL	ATTORNEY	ESTIMATED FEE OF \$5,000.00

(Add sheets if necessary)

Check here if the Disclosing Party has not retained, nor expects to retain, any such persons or entities.

**SECTION V -- CERTIFICATIONS**

**A. COURT-ORDERED CHILD SUPPORT COMPLIANCE**

Under MCC Section 2-92-415, substantial owners of business entities that contract with the City must remain in compliance with their child support obligations throughout the contract's term.

Has any person who directly or indirectly owns 10% or more of the Disclosing Party been declared in arrearage on any child support obligations by any Illinois court of competent jurisdiction?

Yes     No     No person directly or indirectly owns 10% or more of the Disclosing Party.

If "Yes," has the person entered into a court-approved agreement for payment of all support owed and is the person in compliance with that agreement?

Yes     No

**B. FURTHER CERTIFICATIONS**

1. [This paragraph 1 applies only if the Matter is a contract being handled by the City's Department of Procurement Services.] In the 5-year period preceding the date of this EDS, neither the Disclosing Party nor any Affiliated Entity [see definition in (5) below] has engaged, in connection with the performance of any public contract, the services of an integrity monitor, independent private sector inspector general, or integrity compliance consultant (i.e., an individual or entity with legal, auditing, investigative, or other similar skills, designated by a public agency to help the agency monitor the activity of specified agency vendors as well as help the vendors reform their business practices so they can be considered for agency contracts in the future, or continue with a contract in progress).

2. The Disclosing Party and its Affiliated Entities are not delinquent in the payment of any fine, fee, tax or other source of indebtedness owed to the City of Chicago, including, but not limited to, water and sewer charges, license fees, parking tickets, property taxes and sales taxes, nor is the Disclosing Party delinquent in the payment of any tax administered by the Illinois Department of Revenue.

3. The Disclosing Party and, if the Disclosing Party is a legal entity, all of those persons or entities identified in Section II(B)(1) of this EDS:

- a. are not presently debarred, suspended, proposed for debarment, declared ineligible or voluntarily excluded from any transactions by any federal, state or local unit of government;
- b. have not, during the 5 years before the date of this EDS, been convicted of a criminal offense, adjudged guilty, or had a civil judgment rendered against them in connection with: obtaining, attempting to obtain, or performing a public (federal, state or local) transaction or contract under a public transaction; a violation of federal or state antitrust statutes; fraud; embezzlement; theft; forgery; bribery; falsification or destruction of records; making false statements; or receiving stolen property;
- c. are not presently indicted for, or criminally or civilly charged by, a governmental entity (federal, state or local) with committing any of the offenses set forth in subparagraph (b) above;
- d. have not, during the 5 years before the date of this EDS, had one or more public transactions (federal, state or local) terminated for cause or default; and
- e. have not, during the 5 years before the date of this EDS, been convicted, adjudged guilty, or found liable in a civil proceeding, or in any criminal or civil action, including actions concerning environmental violations, instituted by the City or by the federal government, any state, or any other unit of local government.

4. The Disclosing Party understands and shall comply with the applicable requirements of MCC Chapters 2-56 (Inspector General) and 2-156 (Governmental Ethics).

5. Certifications (5), (6) and (7) concern:

- the Disclosing Party;
- any "Contractor" (meaning any contractor or subcontractor used by the Disclosing Party in connection with the Matter, including but not limited to all persons or legal entities disclosed under Section IV, "Disclosure of Subcontractors and Other Retained Parties");
- any "Affiliated Entity" (meaning a person or entity that, directly or indirectly: controls the Disclosing Party, is controlled by the Disclosing Party, or is, with the Disclosing Party, under common control of another person or entity). Indicia of control include, without limitation: interlocking management or ownership; identity of interests among family members, shared facilities and equipment; common use of employees; or organization of a business entity following the ineligibility of a business entity to do business with federal or state or local government, including the City, using substantially the same management, ownership, or principals as the ineligible entity. With respect to Contractors, the term Affiliated Entity means a person or entity that directly or indirectly controls the Contractor, is controlled by it, or, with the Contractor, is under common control of another person or entity;
- any responsible official of the Disclosing Party, any Contractor or any Affiliated Entity or any other official, agent or employee of the Disclosing Party, any Contractor or any Affiliated Entity, acting pursuant to the direction or authorization of a responsible official of the Disclosing Party, any Contractor or any Affiliated Entity (collectively "Agents").

Neither the Disclosing Party, nor any Contractor, nor any Affiliated Entity of either the Disclosing Party or any Contractor, nor any Agents have, during the 5 years before the date of this EDS, or, with respect to a Contractor, an Affiliated Entity, or an Affiliated Entity of a Contractor during the 5 years before the date of such Contractor's or Affiliated Entity's contract or engagement in connection with the Matter:

- a. bribed or attempted to bribe, or been convicted or adjudged guilty of bribery or attempting to bribe, a public officer or employee of the City, the State of Illinois, or any agency of the federal government or of any state or local government in the United States of America, in that officer's or employee's official capacity;
- b. agreed or colluded with other bidders or prospective bidders, or been a party to any such agreement, or been convicted or adjudged guilty of agreement or collusion among bidders or prospective bidders, in restraint of freedom of competition by agreement to bid a fixed price or otherwise; or
- c. made an admission of such conduct described in subparagraph (a) or (b) above that is a matter of record, but have not been prosecuted for such conduct; or
- d. violated the provisions referenced in MCC Subsection 2-92-320(a)(4)(Contracts Requiring a Base Wage); (a)(5)(Debarment Regulations); or (a)(6)(Minimum Wage Ordinance).

6. Neither the Disclosing Party, nor any Affiliated Entity or Contractor, or any of their employees, officials, agents or partners, is barred from contracting with any unit of state or local government as a result of engaging in or being convicted of (1) bid-rigging in violation of 720 ILCS 5/33E-3; (2) bid-rotating in violation of 720 ILCS 5/33E-4; or (3) any similar offense of any state or of the United States of America that contains the same elements as the offense of bid-rigging or bid-rotating.

7. Neither the Disclosing Party nor any Affiliated Entity is listed on a Sanctions List maintained by the United States Department of Commerce, State, or Treasury, or any successor federal agency.

8. [FOR APPLICANT ONLY] (i) Neither the Applicant nor any "controlling person" [see MCC Chapter 1-23, Article I for applicability and defined terms] of the Applicant is currently indicted or charged with, or has admitted guilt of, or has ever been convicted of, or placed under supervision for, any criminal offense involving actual, attempted, or conspiracy to commit bribery, theft, fraud, forgery, perjury, dishonesty or deceit against an officer or employee of the City or any "sister agency"; and (ii) the Applicant understands and acknowledges that compliance with Article I is a continuing requirement for doing business with the City. NOTE: If MCC Chapter 1-23, Article I applies to the Applicant, that Article's permanent compliance timeframe supersedes 5-year compliance timeframes in this Section V.

9. [FOR APPLICANT ONLY] The Applicant and its Affiliated Entities will not use, nor permit their subcontractors to use, any facility listed as having an active exclusion by the U.S. EPA on the federal System for Award Management ("SAM").

10. [FOR APPLICANT ONLY] The Applicant will obtain from any contractors/subcontractors hired or to be hired in connection with the Matter certifications equal in form and substance to those in Certifications (2) and (9) above and will not, without the prior written consent of the City, use any such

contractor/subcontractor that does not provide such certifications or that the Applicant has reason to believe has not provided or cannot provide truthful certifications.

11. If the Disclosing Party is unable to certify to any of the above statements in this Part B (Further Certifications), the Disclosing Party must explain below:

N/A

---

---

---

If the letters "NA," the word "None," or no response appears on the lines above, it will be conclusively presumed that the Disclosing Party certified to the above statements.

12. To the best of the Disclosing Party's knowledge after reasonable inquiry, the following is a complete list of all current employees of the Disclosing Party who were, at any time during the 12-month period preceding the date of this EDS, an employee, or elected or appointed official, of the City of Chicago (if none, indicate with "N/A" or "none").

N/A

---

---

---

13. To the best of the Disclosing Party's knowledge after reasonable inquiry, the following is a complete list of all gifts that the Disclosing Party has given or caused to be given, at any time during the 12-month period preceding the execution date of this EDS, to an employee, or elected or appointed official, of the City of Chicago. For purposes of this statement, a "gift" does not include: (i) anything made generally available to City employees or to the general public, or (ii) food or drink provided in the course of official City business and having a retail value of less than \$25 per recipient, or (iii) a political contribution otherwise duly reported as required by law (if none, indicate with "N/A" or "none"). As to any gift listed below, please also list the name of the City recipient.

N/A

---

---

---

### C. CERTIFICATION OF STATUS AS FINANCIAL INSTITUTION

1. The Disclosing Party certifies that the Disclosing Party (check one)

is  is not

a "financial institution" as defined in MCC Section 2-32-455(b).

2. If the Disclosing Party IS a financial institution, then the Disclosing Party pledges:

"We are not and will not become a predatory lender as defined in MCC Chapter 2-32. We further pledge that none of our affiliates is, and none of them will become, a predatory lender as defined in MCC Chapter 2-32. We understand that becoming a predatory lender or becoming an affiliate of a predatory lender may result in the loss of the privilege of doing business with the City."

If the Disclosing Party is unable to make this pledge because it or any of its affiliates (as defined in MCC Section 2-32-455(b)) is a predatory lender within the meaning of MCC Chapter 2-32, explain here (attach additional pages if necessary):

N/A

---

If the letters "NA," the word "None," or no response appears on the lines above, it will be conclusively presumed that the Disclosing Party certified to the above statements.

**D. CERTIFICATION REGARDING FINANCIAL INTEREST IN CITY BUSINESS**

Any words or terms defined in MCC Chapter 2-156 have the same meanings if used in this Part D.

1. In accordance with MCC Section 2-156-110: To the best of the Disclosing Party's knowledge after reasonable inquiry, does any official or employee of the City have a financial interest in his or her own name or in the name of any other person or entity in the Matter?

Yes                       No

NOTE: If you checked "Yes" to Item D(1), proceed to Items D(2) and D(3). If you checked "No" to Item D(1), skip Items D(2) and D(3) and proceed to Part E.

2. Unless sold pursuant to a process of competitive bidding, or otherwise permitted, no City elected official or employee shall have a financial interest in his or her own name or in the name of any other person or entity in the purchase of any property that (i) belongs to the City, or (ii) is sold for taxes or assessments, or (iii) is sold by virtue of legal process at the suit of the City (collectively, "City Property Sale"). Compensation for property taken pursuant to the City's eminent domain power does not constitute a financial interest within the meaning of this Part D.

Does the Matter involve a City Property Sale?

Yes                       No

3. If you checked "Yes" to Item D(1), provide the names and business addresses of the City officials or employees having such financial interest and identify the nature of the financial interest:

Name	Business Address	Nature of Financial Interest
------	------------------	------------------------------

---

---

---

4. The Disclosing Party further certifies that no prohibited financial interest in the Matter will be acquired by any City official or employee.

E. CERTIFICATION REGARDING SLAVERY ERA BUSINESS

Please check either (1) or (2) below. If the Disclosing Party checks (2), the Disclosing Party must disclose below or in an attachment to this EDS all information required by (2). Failure to comply with these disclosure requirements may make any contract entered into with the City in connection with the Matter voidable by the City.

X 1. The Disclosing Party verifies that the Disclosing Party has searched any and all records of the Disclosing Party and any and all predecessor entities regarding records of investments or profits from slavery or slaveholder insurance policies during the slavery era (including insurance policies issued to slaveholders that provided coverage for damage to or injury or death of their slaves), and the Disclosing Party has found no such records.

\_\_\_ 2. The Disclosing Party verifies that, as a result of conducting the search in step (1) above, the Disclosing Party has found records of investments or profits from slavery or slaveholder insurance policies. The Disclosing Party verifies that the following constitutes full disclosure of all such records, including the names of any and all slaves or slaveholders described in those records:

---

---

---

SECTION VI -- CERTIFICATIONS FOR FEDERALLY FUNDED MATTERS

**NOTE: If the Matter is federally funded, complete this Section VI. If the Matter is not federally funded, proceed to Section VII. For purposes of this Section VI, tax credits allocated by the City and proceeds of debt obligations of the City are not federal funding.**

A. CERTIFICATION REGARDING LOBBYING

1. List below the names of all persons or entities registered under the federal Lobbying Disclosure Act of 1995, as amended, who have made lobbying contacts on behalf of the Disclosing Party with respect to the Matter: (Add sheets if necessary):

---

---

---

(If no explanation appears or begins on the lines above, or if the letters "NA" or if the word "None" appear, it will be conclusively presumed that the Disclosing Party means that NO persons or entities registered under the Lobbying Disclosure Act of 1995, as amended, have made lobbying contacts on behalf of the Disclosing Party with respect to the Matter.)

2. The Disclosing Party has not spent and will not expend any federally appropriated funds to pay any person or entity listed in paragraph A(1) above for his or her lobbying activities or to pay any person or entity to influence or attempt to influence an officer or employee of any agency, as defined by applicable federal law, a member of Congress, an officer or employee of Congress, or an employee



of a member of Congress, in connection with the award of any federally funded contract, making any federally funded grant or loan, entering into any cooperative agreement, or to extend, continue, renew, amend, or modify any federally funded contract, grant, loan, or cooperative agreement.

3. The Disclosing Party will submit an updated certification at the end of each calendar quarter in which there occurs any event that materially affects the accuracy of the statements and information set forth in paragraphs A(1) and A(2) above.

4. The Disclosing Party certifies that either: (i) it is not an organization described in section 501(c)(4) of the Internal Revenue Code of 1986; or (ii) it is an organization described in section 501(c)(4) of the Internal Revenue Code of 1986 but has not engaged and will not engage in "Lobbying Activities," as that term is defined in the Lobbying Disclosure Act of 1995, as amended.

5. If the Disclosing Party is the Applicant, the Disclosing Party must obtain certifications equal in form and substance to paragraphs A(1) through A(4) above from all subcontractors before it awards any subcontract and the Disclosing Party must maintain all such subcontractors' certifications for the duration of the Matter and must make such certifications promptly available to the City upon request.

#### B. CERTIFICATION REGARDING EQUAL EMPLOYMENT OPPORTUNITY

If the Matter is federally funded, federal regulations require the Applicant and all proposed subcontractors to submit the following information with their bids or in writing at the outset of negotiations.

Is the Disclosing Party the Applicant?

Yes                       No

If "Yes," answer the three questions below:

1. Have you developed and do you have on file affirmative action programs pursuant to applicable federal regulations? (See 41 CFR Part 60-2.)

Yes                       No

2. Have you filed with the Joint Reporting Committee, the Director of the Office of Federal Contract Compliance Programs, or the Equal Employment Opportunity Commission all reports due under the applicable filing requirements?

Yes                       No                       Reports not required

3. Have you participated in any previous contracts or subcontracts subject to the equal opportunity clause?

Yes                       No

If you checked "No" to question (1) or (2) above, please provide an explanation:

---

---

## SECTION VII -- FURTHER ACKNOWLEDGMENTS AND CERTIFICATION

The Disclosing Party understands and agrees that:

A. The certifications, disclosures, and acknowledgments contained in this EDS will become part of any contract or other agreement between the Applicant and the City in connection with the Matter, whether procurement, City assistance, or other City action, and are material inducements to the City's execution of any contract or taking other action with respect to the Matter. The Disclosing Party understands that it must comply with all statutes, ordinances, and regulations on which this EDS is based.

B. The City's Governmental Ethics Ordinance, MCC Chapter 2-156, imposes certain duties and obligations on persons or entities seeking City contracts, work, business, or transactions. The full text of this ordinance and a training program is available on line at [www.cityofchicago.org/Ethics](http://www.cityofchicago.org/Ethics), and may also be obtained from the City's Board of Ethics, 740 N. Sedgwick St., Suite 500, Chicago, IL 60610, (312) 744-9660. The Disclosing Party must comply fully with this ordinance.

C. If the City determines that any information provided in this EDS is false, incomplete or inaccurate, any contract or other agreement in connection with which it is submitted may be rescinded or be void or voidable, and the City may pursue any remedies under the contract or agreement (if not rescinded or void), at law, or in equity, including terminating the Disclosing Party's participation in the Matter and/or declining to allow the Disclosing Party to participate in other City transactions. Remedies at law for a false statement of material fact may include incarceration and an award to the City of treble damages.

D. It is the City's policy to make this document available to the public on its Internet site and/or upon request. Some or all of the information provided in, and appended to, this EDS may be made publicly available on the Internet, in response to a Freedom of Information Act request, or otherwise. By completing and signing this EDS, the Disclosing Party waives and releases any possible rights or claims which it may have against the City in connection with the public release of information contained in this EDS and also authorizes the City to verify the accuracy of any information submitted in this EDS.

E. The information provided in this EDS must be kept current. In the event of changes, the Disclosing Party must supplement this EDS up to the time the City takes action on the Matter. If the Matter is a contract being handled by the City's Department of Procurement Services, the Disclosing Party must update this EDS as the contract requires. **NOTE:** With respect to Matters subject to MCC Chapter 1-23, Article I (imposing **PERMANENT INELIGIBILITY** for certain specified offenses), the information provided herein regarding eligibility must be kept current for a longer period, as required by MCC Chapter 1-23 and Section 2-154-020.

**CERTIFICATION**

Under penalty of perjury, the person signing below: (1) warrants that he/she is authorized to execute this EDS, and Appendices A and B (if applicable), on behalf of the Disclosing Party, and (2) warrants that all certifications and statements contained in this EDS, and Appendices A and B (if applicable), are true, accurate and complete as of the date furnished to the City.

EZMB, LLC (Applicant)  
(Print or type exact legal name of Disclosing Party)

By:   
(Sign here)

Zdzislaw Banys  
(Print or type name of person signing)

Manager of EZMB, LLC  
(Print or type title of person signing)

Signed and sworn to before me on (date) August 23, 2017,

at COOK County, ILLINOIS (state).

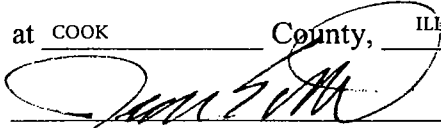
  
Notary Public

Commission expires: \_\_\_\_\_

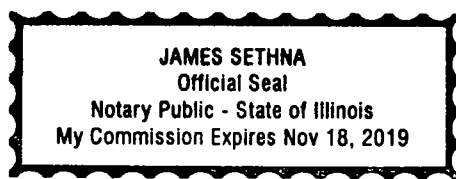

**CITY OF CHICAGO  
ECONOMIC DISCLOSURE STATEMENT AND AFFIDAVIT  
APPENDIX A**

**FAMILIAL RELATIONSHIPS WITH ELECTED CITY OFFICIALS  
AND DEPARTMENT HEADS**

**This Appendix is to be completed only by (a) the Applicant, and (b) any legal entity which has a direct ownership interest in the Applicant exceeding 7.5%. It is not to be completed by any legal entity which has only an indirect ownership interest in the Applicant.**

Under MCC Section 2-154-015, the Disclosing Party must disclose whether such Disclosing Party or any "Applicable Party" or any Spouse or Domestic Partner thereof currently has a "familial relationship" with any elected city official or department head. A "familial relationship" exists if, as of the date this EDS is signed, the Disclosing Party or any "Applicable Party" or any Spouse or Domestic Partner thereof is related to the mayor, any alderman, the city clerk, the city treasurer or any city department head as spouse or domestic partner or as any of the following, whether by blood or adoption: parent, child, brother or sister, aunt or uncle, niece or nephew, grandparent, grandchild, father-in-law, mother-in-law, son-in-law, daughter-in-law, stepfather or stepmother, stepson or stepdaughter, stepbrother or stepsister or half-brother or half-sister.

"Applicable Party" means (1) all executive officers of the Disclosing Party listed in Section II.B.1.a., if the Disclosing Party is a corporation; all partners of the Disclosing Party, if the Disclosing Party is a general partnership; all general partners and limited partners of the Disclosing Party, if the Disclosing Party is a limited partnership; all managers, managing members and members of the Disclosing Party, if the Disclosing Party is a limited liability company; (2) all principal officers of the Disclosing Party; and (3) any person having more than a 7.5% ownership interest in the Disclosing Party. "Principal officers" means the president, chief operating officer, executive director, chief financial officer, treasurer or secretary of a legal entity or any person exercising similar authority.

Does the Disclosing Party or any "Applicable Party" or any Spouse or Domestic Partner thereof currently have a "familial relationship" with an elected city official or department head?

[ ] Yes                      [ X ] No

If yes, please identify below (1) the name and title of such person, (2) the name of the legal entity to which such person is connected; (3) the name and title of the elected city official or department head to whom such person has a familial relationship, and (4) the precise nature of such familial relationship.

---

---

---

**CITY OF CHICAGO  
ECONOMIC DISCLOSURE STATEMENT AND AFFIDAVIT  
APPENDIX B**

**BUILDING CODE SCOFFLAW/PROBLEM LANDLORD CERTIFICATION**

This Appendix is to be completed only by (a) the Applicant, and (b) any legal entity which has a direct ownership interest in the Applicant exceeding 7.5% (an "Owner"). It is not to be completed by any legal entity which has only an indirect ownership interest in the Applicant.

1. Pursuant to MCC Section 2-154-010, is the Applicant or any Owner identified as a building code scofflaw or problem landlord pursuant to MCC Section 2-92-416?

Yes                       No

2. If the Applicant is a legal entity publicly traded on any exchange, is any officer or director of the Applicant identified as a building code scofflaw or problem landlord pursuant to MCC Section 2-92-416?

Yes                       No                       The Applicant is not publicly traded on any exchange.

3. If yes to (1) or (2) above, please identify below the name of each person or legal entity identified as a building code scofflaw or problem landlord and the address of each building or buildings to which the pertinent code violations apply.

---

---

---

**CITY OF CHICAGO  
ECONOMIC DISCLOSURE STATEMENT  
AND AFFIDAVIT**

**SECTION I -- GENERAL INFORMATION**

A. Legal name of the Disclosing Party submitting this EDS. Include d/b/a/ if applicable:

Zdzislaw Banys

Check ONE of the following three boxes:

Indicate whether the Disclosing Party submitting this EDS is:

1.  the Applicant

OR

2.  a legal entity currently holding, or anticipated to hold within six months after City action on the contract, transaction or other undertaking to which this EDS pertains (referred to below as the "Matter"), a direct or indirect interest in excess of 7.5% in the Applicant. State the Applicant's legal name: \_\_\_\_\_

OR

3.  a legal entity with a direct or indirect right of control of the Applicant (see Section II(B)(1)) State the legal name of the entity in which the Disclosing Party holds a right of control:

EZMB, LLC

B. Business address of the Disclosing Party: 1416 N. Western Ave.  
Chicago, IL 60642

C. Telephone: (773) 489-3000 Fax: n/a Email: n/a

D. Name of contact person: Zdzislaw Banys

E. Federal Employer Identification No. (if you have one): Not Applicable

F. Brief description of the Matter to which this EDS pertains. (Include project number and location of property, if applicable):

ZONING CHANGE OF 1515 WEST WALTON ST., CHICAGO, ILLINOIS

G. Which City agency or department is requesting this EDS? DEPARTMENT OF PLANNING AND DEVELOPMENT

If the Matter is a contract being handled by the City's Department of Procurement Services, please complete the following:

Specification # \_\_\_\_\_ and Contract # \_\_\_\_\_

**SECTION II -- DISCLOSURE OF OWNERSHIP INTERESTS**

**A. NATURE OF THE DISCLOSING PARTY**

1. Indicate the nature of the Disclosing Party:

- |   |  |
|---|--|
| <input checked="" type="checkbox"/> Person                        | <input type="checkbox"/> Limited liability company       |
| <input type="checkbox"/> Publicly registered business corporation | <input type="checkbox"/> Limited liability partnership   |
| <input type="checkbox"/> Privately held business corporation      | <input type="checkbox"/> Joint venture                   |
| <input type="checkbox"/> Sole proprietorship                      | <input type="checkbox"/> Not-for-profit corporation      |
| <input type="checkbox"/> General partnership                      | (Is the not-for-profit corporation also a 501(c)(3))?    |
| <input type="checkbox"/> Limited partnership                      | <input type="checkbox"/> Yes <input type="checkbox"/> No |
| <input type="checkbox"/> Trust                                    | <input type="checkbox"/> Other (please specify)          |
- 

2. For legal entities, the state (or foreign country) of incorporation or organization, if applicable:

---

3. For legal entities not organized in the State of Illinois: Has the organization registered to do business in the State of Illinois as a foreign entity?

- Yes                       No                       Organized in Illinois

**B. IF THE DISCLOSING PARTY IS A LEGAL ENTITY:**

1. List below the full names and titles, if applicable, of: (i) all executive officers and all directors of the entity; (ii) **for not-for-profit corporations**, all members, if any, which are legal entities (if there are no such members, write "no members which are legal entities"); (iii) **for trusts, estates or other similar entities**, the trustee, executor, administrator, or similarly situated party; (iv) **for general or limited partnerships, limited liability companies, limited liability partnerships or joint ventures**, each general partner, managing member, manager or any other person or legal entity that directly or indirectly controls the day-to-day management of the Applicant.

**NOTE:** Each legal entity listed below must submit an EDS on its own behalf.

Name	Title
------	-------

---

---

---

2. Please provide the following information concerning each person or legal entity having a direct or indirect, current or prospective (i.e. within 6 months after City action) beneficial interest (including ownership) in excess of 7.5% of the Applicant. Examples of such an interest include shares in a corporation, partnership interest in a partnership or joint venture, interest of a member or manager in a

limited liability company, or interest of a beneficiary of a trust, estate or other similar entity. If none, state "None."

NOTE: Each legal entity listed below may be required to submit an EDS on its own behalf.

Name	Business Address	Percentage Interest in the Applicant
------	------------------	--------------------------------------

---

---

---

**SECTION III -- INCOME OR COMPENSATION TO, OR OWNERSHIP BY, CITY ELECTED OFFICIALS**

Has the Disclosing Party provided any income or compensation to any City elected official during the 12-month period preceding the date of this EDS?       Yes       No

Does the Disclosing Party reasonably expect to provide any income or compensation to any City elected official during the 12-month period following the date of this EDS?       Yes       No

If "yes" to either of the above, please identify below the name(s) of such City elected official(s) and describe such income or compensation:

---

---

Does any City elected official or, to the best of the Disclosing Party's knowledge after reasonable inquiry, any City elected official's spouse or domestic partner, have a financial interest (as defined in Chapter 2-156 of the Municipal Code of Chicago ("MCC")) in the Disclosing Party?

Yes       No

If "yes," please identify below the name(s) of such City elected official(s) and/or spouse(s)/domestic partner(s) and describe the financial interest(s).

---

---

**SECTION IV -- DISCLOSURE OF SUBCONTRACTORS AND OTHER RETAINED PARTIES**

The Disclosing Party must disclose the name and business address of each subcontractor, attorney, lobbyist (as defined in MCC Chapter 2-156), accountant, consultant and any other person or entity whom the Disclosing Party has retained or expects to retain in connection with the Matter, as well as the nature of the relationship, and the total amount of the fees paid or estimated to be paid. The Disclosing Party is not required to disclose employees who are paid solely through the Disclosing Party's regular payroll. If the Disclosing Party is uncertain whether a disclosure is required under this Section, the Disclosing Party must either ask the City whether disclosure is required or make the disclosure.



Name (indicate whether retained or anticipated to be retained)	Business Address	Relationship to Disclosing Party (subcontractor, attorney, lobbyist, etc.)	Fees (indicate whether paid or estimated.) NOTE: "hourly rate" or "t.b.d." is not an acceptable response.
--	------------------	--	---

Counsel is attained by Applicant , EZMB, LLC

---



---

(Add sheets if necessary)

Check here if the Disclosing Party has not retained, nor expects to retain, any such persons or entities.

**SECTION V -- CERTIFICATIONS**

**A. COURT-ORDERED CHILD SUPPORT COMPLIANCE**

Under MCC Section 2-92-415, substantial owners of business entities that contract with the City must remain in compliance with their child support obligations throughout the contract's term.

Has any person who directly or indirectly owns 10% or more of the Disclosing Party been declared in arrearage on any child support obligations by any Illinois court of competent jurisdiction?

Yes     No     No person directly or indirectly owns 10% or more of the Disclosing Party.

If "Yes," has the person entered into a court-approved agreement for payment of all support owed and is the person in compliance with that agreement?

Yes     No

**B. FURTHER CERTIFICATIONS**

1. [This paragraph 1 applies only if the Matter is a contract being handled by the City's Department of Procurement Services.] In the 5-year period preceding the date of this EDS, neither the Disclosing Party nor any Affiliated Entity [see definition in (5) below] has engaged, in connection with the performance of any public contract, the services of an integrity monitor, independent private sector inspector general, or integrity compliance consultant (i.e., an individual or entity with legal, auditing, investigative, or other similar skills, designated by a public agency to help the agency monitor the activity of specified agency vendors as well as help the vendors reform their business practices so they can be considered for agency contracts in the future, or continue with a contract in progress).

2. The Disclosing Party and its Affiliated Entities are not delinquent in the payment of any fine, fee, tax or other source of indebtedness owed to the City of Chicago, including, but not limited to, water and sewer charges, license fees, parking tickets, property taxes and sales taxes, nor is the Disclosing Party delinquent in the payment of any tax administered by the Illinois Department of Revenue.

3. The Disclosing Party and, if the Disclosing Party is a legal entity, all of those persons or entities identified in Section II(B)(1) of this EDS:

- a. are not presently debarred, suspended, proposed for debarment, declared ineligible or voluntarily excluded from any transactions by any federal, state or local unit of government;
- b. have not, during the 5 years before the date of this EDS, been convicted of a criminal offense, adjudged guilty, or had a civil judgment rendered against them in connection with: obtaining, attempting to obtain, or performing a public (federal, state or local) transaction or contract under a public transaction; a violation of federal or state antitrust statutes; fraud; embezzlement; theft; forgery; bribery; falsification or destruction of records; making false statements; or receiving stolen property;
- c. are not presently indicted for, or criminally or civilly charged by, a governmental entity (federal, state or local) with committing any of the offenses set forth in subparagraph (b) above;
- d. have not, during the 5 years before the date of this EDS, had one or more public transactions (federal, state or local) terminated for cause or default; and
- e. have not, during the 5 years before the date of this EDS, been convicted, adjudged guilty, or found liable in a civil proceeding, or in any criminal or civil action, including actions concerning environmental violations, instituted by the City or by the federal government, any state, or any other unit of local government.

4. The Disclosing Party understands and shall comply with the applicable requirements of MCC Chapters 2-56 (Inspector General) and 2-156 (Governmental Ethics).

5. Certifications (5), (6) and (7) concern:

- the Disclosing Party;
- any "Contractor" (meaning any contractor or subcontractor used by the Disclosing Party in connection with the Matter, including but not limited to all persons or legal entities disclosed under Section IV, "Disclosure of Subcontractors and Other Retained Parties");
- any "Affiliated Entity" (meaning a person or entity that, directly or indirectly: controls the Disclosing Party, is controlled by the Disclosing Party, or is, with the Disclosing Party, under common control of another person or entity). Indicia of control include, without limitation: interlocking management or ownership; identity of interests among family members, shared facilities and equipment; common use of employees; or organization of a business entity following the ineligibility of a business entity to do business with federal or state or local government, including the City, using substantially the same management, ownership, or principals as the ineligible entity. With respect to Contractors, the term Affiliated Entity means a person or entity that directly or indirectly controls the Contractor, is controlled by it, or, with the Contractor, is under common control of another person or entity;
- any responsible official of the Disclosing Party, any Contractor or any Affiliated Entity or any other official, agent or employee of the Disclosing Party, any Contractor or any Affiliated Entity, acting pursuant to the direction or authorization of a responsible official of the Disclosing Party, any Contractor or any Affiliated Entity (collectively "Agents").

Neither the Disclosing Party, nor any Contractor, nor any Affiliated Entity of either the Disclosing Party or any Contractor, nor any Agents have, during the 5 years before the date of this EDS, or, with respect to a Contractor, an Affiliated Entity, or an Affiliated Entity of a Contractor during the 5 years before the date of such Contractor's or Affiliated Entity's contract or engagement in connection with the Matter:

- a. bribed or attempted to bribe, or been convicted or adjudged guilty of bribery or attempting to bribe, a public officer or employee of the City, the State of Illinois, or any agency of the federal government or of any state or local government in the United States of America, in that officer's or employee's official capacity;
- b. agreed or colluded with other bidders or prospective bidders, or been a party to any such agreement, or been convicted or adjudged guilty of agreement or collusion among bidders or prospective bidders, in restraint of freedom of competition by agreement to bid a fixed price or otherwise; or
- c. made an admission of such conduct described in subparagraph (a) or (b) above that is a matter of record, but have not been prosecuted for such conduct; or
- d. violated the provisions referenced in MCC Subsection 2-92-320(a)(4)(Contracts Requiring a Base Wage); (a)(5)(Debarment Regulations); or (a)(6)(Minimum Wage Ordinance).

6. Neither the Disclosing Party, nor any Affiliated Entity or Contractor, or any of their employees, officials, agents or partners, is barred from contracting with any unit of state or local government as a result of engaging in or being convicted of (1) bid-rigging in violation of 720 ILCS 5/33E-3; (2) bid-rotating in violation of 720 ILCS 5/33E-4; or (3) any similar offense of any state or of the United States of America that contains the same elements as the offense of bid-rigging or bid-rotating.

7. Neither the Disclosing Party nor any Affiliated Entity is listed on a Sanctions List maintained by the United States Department of Commerce, State, or Treasury, or any successor federal agency.

8. [FOR APPLICANT ONLY] (i) Neither the Applicant nor any "controlling person" [see MCC Chapter 1-23, Article I for applicability and defined terms] of the Applicant is currently indicted or charged with, or has admitted guilt of, or has ever been convicted of, or placed under supervision for, any criminal offense involving actual, attempted, or conspiracy to commit bribery, theft, fraud, forgery, perjury, dishonesty or deceit against an officer or employee of the City or any "sister agency"; and (ii) the Applicant understands and acknowledges that compliance with Article I is a continuing requirement for doing business with the City. NOTE: If MCC Chapter 1-23, Article I applies to the Applicant, that Article's permanent compliance timeframe supersedes 5-year compliance timeframes in this Section V.

9. [FOR APPLICANT ONLY] The Applicant and its Affiliated Entities will not use, nor permit their subcontractors to use, any facility listed as having an active exclusion by the U.S. EPA on the federal System for Award Management ("SAM").

10. [FOR APPLICANT ONLY] The Applicant will obtain from any contractors/subcontractors hired or to be hired in connection with the Matter certifications equal in form and substance to those in Certifications (2) and (9) above and will not, without the prior written consent of the City, use any such

contractor/subcontractor that does not provide such certifications or that the Applicant has reason to believe has not provided or cannot provide truthful certifications.

11. If the Disclosing Party is unable to certify to any of the above statements in this Part B (Further Certifications), the Disclosing Party must explain below:

N/A

---

---

---

If the letters "NA," the word "None," or no response appears on the lines above, it will be conclusively presumed that the Disclosing Party certified to the above statements.

12. To the best of the Disclosing Party's knowledge after reasonable inquiry, the following is a complete list of all current employees of the Disclosing Party who were, at any time during the 12-month period preceding the date of this EDS, an employee, or elected or appointed official, of the City of Chicago (if none, indicate with "N/A" or "none").

N/A

---

---

---

13. To the best of the Disclosing Party's knowledge after reasonable inquiry, the following is a complete list of all gifts that the Disclosing Party has given or caused to be given, at any time during the 12-month period preceding the execution date of this EDS, to an employee, or elected or appointed official, of the City of Chicago. For purposes of this statement, a "gift" does not include: (i) anything made generally available to City employees or to the general public, or (ii) food or drink provided in the course of official City business and having a retail value of less than \$25 per recipient, or (iii) a political contribution otherwise duly reported as required by law (if none, indicate with "N/A" or "none"). As to any gift listed below, please also list the name of the City recipient.

N/A

---

---

---

### C. CERTIFICATION OF STATUS AS FINANCIAL INSTITUTION

1. The Disclosing Party certifies that the Disclosing Party (check one)

is  is not

a "financial institution" as defined in MCC Section 2-32-455(b).

2. If the Disclosing Party IS a financial institution, then the Disclosing Party pledges:

"We are not and will not become a predatory lender as defined in MCC Chapter 2-32. We further pledge that none of our affiliates is, and none of them will become, a predatory lender as defined in MCC Chapter 2-32. We understand that becoming a predatory lender or becoming an affiliate of a predatory lender may result in the loss of the privilege of doing business with the City."

If the Disclosing Party is unable to make this pledge because it or any of its affiliates (as defined in MCC Section 2-32-455(b)) is a predatory lender within the meaning of MCC Chapter 2-32, explain here (attach additional pages if necessary):

N/A

---

If the letters "NA," the word "None," or no response appears on the lines above, it will be conclusively presumed that the Disclosing Party certified to the above statements.

**D. CERTIFICATION REGARDING FINANCIAL INTEREST IN CITY BUSINESS**

Any words or terms defined in MCC Chapter 2-156 have the same meanings if used in this Part D.

1. In accordance with MCC Section 2-156-110: To the best of the Disclosing Party's knowledge after reasonable inquiry, does any official or employee of the City have a financial interest in his or her own name or in the name of any other person or entity in the Matter?

Yes                       No

NOTE: If you checked "Yes" to Item D(1), proceed to Items D(2) and D(3). If you checked "No" to Item D(1), skip Items D(2) and D(3) and proceed to Part E.

2. Unless sold pursuant to a process of competitive bidding, or otherwise permitted, no City elected official or employee shall have a financial interest in his or her own name or in the name of any other person or entity in the purchase of any property that (i) belongs to the City, or (ii) is sold for taxes or assessments, or (iii) is sold by virtue of legal process at the suit of the City (collectively, "City Property Sale"). Compensation for property taken pursuant to the City's eminent domain power does not constitute a financial interest within the meaning of this Part D.

Does the Matter involve a City Property Sale?

Yes                       No

3. If you checked "Yes" to Item D(1), provide the names and business addresses of the City officials or employees having such financial interest and identify the nature of the financial interest:

Name	Business Address	Nature of Financial Interest

4. The Disclosing Party further certifies that no prohibited financial interest in the Matter will be acquired by any City official or employee.

E. CERTIFICATION REGARDING SLAVERY ERA BUSINESS

Please check either (1) or (2) below. If the Disclosing Party checks (2), the Disclosing Party must disclose below or in an attachment to this EDS all information required by (2). Failure to comply with these disclosure requirements may make any contract entered into with the City in connection with the Matter voidable by the City.

X 1. The Disclosing Party verifies that the Disclosing Party has searched any and all records of the Disclosing Party and any and all predecessor entities regarding records of investments or profits from slavery or slaveholder insurance policies during the slavery era (including insurance policies issued to slaveholders that provided coverage for damage to or injury or death of their slaves), and the Disclosing Party has found no such records.

2. The Disclosing Party verifies that, as a result of conducting the search in step (1) above, the Disclosing Party has found records of investments or profits from slavery or slaveholder insurance policies. The Disclosing Party verifies that the following constitutes full disclosure of all such records, including the names of any and all slaves or slaveholders described in those records:

---

---

---

SECTION VI -- CERTIFICATIONS FOR FEDERALLY FUNDED MATTERS

**NOTE: If the Matter is federally funded, complete this Section VI. If the Matter is not federally funded, proceed to Section VII. For purposes of this Section VI, tax credits allocated by the City and proceeds of debt obligations of the City are not federal funding.**

A. CERTIFICATION REGARDING LOBBYING

1. List below the names of all persons or entities registered under the federal Lobbying Disclosure Act of 1995, as amended, who have made lobbying contacts on behalf of the Disclosing Party with respect to the Matter: (Add sheets if necessary):

---

---

---

(If no explanation appears or begins on the lines above, or if the letters "NA" or if the word "None" appear, it will be conclusively presumed that the Disclosing Party means that NO persons or entities registered under the Lobbying Disclosure Act of 1995, as amended, have made lobbying contacts on behalf of the Disclosing Party with respect to the Matter.)

2. The Disclosing Party has not spent and will not expend any federally appropriated funds to pay any person or entity listed in paragraph A(1) above for his or her lobbying activities or to pay any person or entity to influence or attempt to influence an officer or employee of any agency, as defined by applicable federal law, a member of Congress, an officer or employee of Congress, or an employee

of a member of Congress, in connection with the award of any federally funded contract, making any federally funded grant or loan, entering into any cooperative agreement, or to extend, continue, renew, amend, or modify any federally funded contract, grant, loan, or cooperative agreement.

3. The Disclosing Party will submit an updated certification at the end of each calendar quarter in which there occurs any event that materially affects the accuracy of the statements and information set forth in paragraphs A(1) and A(2) above.

4. The Disclosing Party certifies that either: (i) it is not an organization described in section 501(c)(4) of the Internal Revenue Code of 1986; or (ii) it is an organization described in section 501(c)(4) of the Internal Revenue Code of 1986 but has not engaged and will not engage in "Lobbying Activities," as that term is defined in the Lobbying Disclosure Act of 1995, as amended.

5. If the Disclosing Party is the Applicant, the Disclosing Party must obtain certifications equal in form and substance to paragraphs A(1) through A(4) above from all subcontractors before it awards any subcontract and the Disclosing Party must maintain all such subcontractors' certifications for the duration of the Matter and must make such certifications promptly available to the City upon request.

#### B. CERTIFICATION REGARDING EQUAL EMPLOYMENT OPPORTUNITY

If the Matter is federally funded, federal regulations require the Applicant and all proposed subcontractors to submit the following information with their bids or in writing at the outset of negotiations.

Is the Disclosing Party the Applicant?

Yes                       No

If "Yes," answer the three questions below:

1. Have you developed and do you have on file affirmative action programs pursuant to applicable federal regulations? (See 41 CFR Part 60-2.)

Yes                       No

2. Have you filed with the Joint Reporting Committee, the Director of the Office of Federal Contract Compliance Programs, or the Equal Employment Opportunity Commission all reports due under the applicable filing requirements?

Yes                       No                       Reports not required

3. Have you participated in any previous contracts or subcontracts subject to the equal opportunity clause?

Yes                       No

If you checked "No" to question (1) or (2) above, please provide an explanation:

---

---

## SECTION VII -- FURTHER ACKNOWLEDGMENTS AND CERTIFICATION

The Disclosing Party understands and agrees that:

A. The certifications, disclosures, and acknowledgments contained in this EDS will become part of any contract or other agreement between the Applicant and the City in connection with the Matter, whether procurement, City assistance, or other City action, and are material inducements to the City's execution of any contract or taking other action with respect to the Matter. The Disclosing Party understands that it must comply with all statutes, ordinances, and regulations on which this EDS is based.

B. The City's Governmental Ethics Ordinance, MCC Chapter 2-156, imposes certain duties and obligations on persons or entities seeking City contracts, work, business, or transactions. The full text of this ordinance and a training program is available on line at [www.cityofchicago.org/Ethics](http://www.cityofchicago.org/Ethics), and may also be obtained from the City's Board of Ethics, 740 N. Sedgwick St., Suite 500, Chicago, IL 60610, (312) 744-9660. The Disclosing Party must comply fully with this ordinance.

C. If the City determines that any information provided in this EDS is false, incomplete or inaccurate, any contract or other agreement in connection with which it is submitted may be rescinded or be void or voidable, and the City may pursue any remedies under the contract or agreement (if not rescinded or void), at law, or in equity, including terminating the Disclosing Party's participation in the Matter and/or declining to allow the Disclosing Party to participate in other City transactions. Remedies at law for a false statement of material fact may include incarceration and an award to the City of treble damages.

D. It is the City's policy to make this document available to the public on its Internet site and/or upon request. Some or all of the information provided in, and appended to, this EDS may be made publicly available on the Internet, in response to a Freedom of Information Act request, or otherwise. By completing and signing this EDS, the Disclosing Party waives and releases any possible rights or claims which it may have against the City in connection with the public release of information contained in this EDS and also authorizes the City to verify the accuracy of any information submitted in this EDS.

E. The information provided in this EDS must be kept current. In the event of changes, the Disclosing Party must supplement this EDS up to the time the City takes action on the Matter. If the Matter is a contract being handled by the City's Department of Procurement Services, the Disclosing Party must update this EDS as the contract requires. **NOTE:** With respect to Matters subject to MCC Chapter 1-23, Article I (imposing **PERMANENT INELIGIBILITY** for certain specified offenses), the information provided herein regarding eligibility must be kept current for a longer period, as required by MCC Chapter 1-23 and Section 2-154-020.



**CERTIFICATION**

Under penalty of perjury, the person signing below: (1) warrants that he/she is authorized to execute this EDS, and Appendices A and B (if applicable), on behalf of the Disclosing Party, and (2) warrants that all certifications and statements contained in this EDS, and Appendices A and B (if applicable), are true, accurate and complete as of the date furnished to the City.

Zdzislaw Banys

(Print or type exact legal name of Disclosing Party)

By: \_\_\_\_\_

  
(Sign here)

Zdzislaw Banys

(Print or type name of person signing)

Manager of EZMB, LLC

(Print or type title of person signing)

Signed and sworn to before me on (date) August 23, 2017,

at COOK County, ILLINOIS (state).

  
\_\_\_\_\_  
Notary Public

Commission expires: \_\_\_\_\_

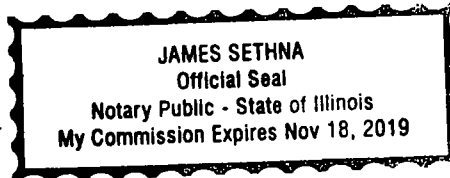

**CITY OF CHICAGO  
ECONOMIC DISCLOSURE STATEMENT AND AFFIDAVIT  
APPENDIX A**

**FAMILIAL RELATIONSHIPS WITH ELECTED CITY OFFICIALS  
AND DEPARTMENT HEADS**

**This Appendix is to be completed only by (a) the Applicant, and (b) any legal entity which has a direct ownership interest in the Applicant exceeding 7.5%. It is not to be completed by any legal entity which has only an indirect ownership interest in the Applicant.**

Under MCC Section 2-154-015, the Disclosing Party must disclose whether such Disclosing Party or any "Applicable Party" or any Spouse or Domestic Partner thereof currently has a "familial relationship" with any elected city official or department head. A "familial relationship" exists if, as of the date this EDS is signed, the Disclosing Party or any "Applicable Party" or any Spouse or Domestic Partner thereof is related to the mayor, any alderman, the city clerk, the city treasurer or any city department head as spouse or domestic partner or as any of the following, whether by blood or adoption: parent, child, brother or sister, aunt or uncle, niece or nephew, grandparent, grandchild, father-in-law, mother-in-law, son-in-law, daughter-in-law, stepfather or stepmother, stepson or stepdaughter, stepbrother or stepsister or half-brother or half-sister.

"Applicable Party" means (1) all executive officers of the Disclosing Party listed in Section II.B.1.a., if the Disclosing Party is a corporation; all partners of the Disclosing Party, if the Disclosing Party is a general partnership; all general partners and limited partners of the Disclosing Party, if the Disclosing Party is a limited partnership; all managers, managing members and members of the Disclosing Party, if the Disclosing Party is a limited liability company; (2) all principal officers of the Disclosing Party; and (3) any person having more than a 7.5% ownership interest in the Disclosing Party. "Principal officers" means the president, chief operating officer, executive director, chief financial officer, treasurer or secretary of a legal entity or any person exercising similar authority.

Does the Disclosing Party or any "Applicable Party" or any Spouse or Domestic Partner thereof currently have a "familial relationship" with an elected city official or department head?

Yes

No

If yes, please identify below (1) the name and title of such person, (2) the name of the legal entity to which such person is connected; (3) the name and title of the elected city official or department head to whom such person has a familial relationship, and (4) the precise nature of such familial relationship.

---

---

---

**CITY OF CHICAGO  
ECONOMIC DISCLOSURE STATEMENT AND AFFIDAVIT  
APPENDIX B**

**BUILDING CODE SCOFFLAW/PROBLEM LANDLORD CERTIFICATION**

This Appendix is to be completed only by (a) the Applicant, and (b) any legal entity which has a direct ownership interest in the Applicant exceeding 7.5% (an "Owner"). It is not to be completed by any legal entity which has only an indirect ownership interest in the Applicant.

1. Pursuant to MCC Section 2-154-010, is the Applicant or any Owner identified as a building code scofflaw or problem landlord pursuant to MCC Section 2-92-416?

Yes                       No

2. If the Applicant is a legal entity publicly traded on any exchange, is any officer or director of the Applicant identified as a building code scofflaw or problem landlord pursuant to MCC Section 2-92-416?

Yes                       No                       The Applicant is not publicly traded on any exchange.

3. If yes to (1) or (2) above, please identify below the name of each person or legal entity identified as a building code scofflaw or problem landlord and the address of each building or buildings to which the pertinent code violations apply.

---

---

---

**CITY OF CHICAGO  
ECONOMIC DISCLOSURE STATEMENT  
AND AFFIDAVIT**

**SECTION I -- GENERAL INFORMATION**

A. Legal name of the Disclosing Party submitting this EDS. Include d/b/a/ if applicable:

Cirilo Garcia a/k/a Cirilo Camacho Garcia  
\_\_\_\_\_

**Check ONE of the following three boxes:**

Indicate whether the Disclosing Party submitting this EDS is:

1.  The owner of 1515 W. Walton

OR

2.  a legal entity currently holding, or anticipated to hold within six months after City action on the contract, transaction or other undertaking to which this EDS pertains (referred to below as the "Matter"), a direct or indirect interest in excess of 7.5% in the Applicant. State the Applicant's legal name: \_\_\_\_\_

OR

3.  a legal entity with a direct or indirect right of control of the Applicant (see Section II(B)(1)) State the legal name of the entity in which the Disclosing Party holds a right of control: \_\_\_\_\_

B. Business address of the Disclosing Party:

1515 W. Walton St.

Chicago, IL 60642

C. Telephone \_\_\_\_\_

Fax: n/a

Email: n/a

D. Name of contact person: Michael A. Perez, Esq.

E. Federal Employer Identification No. (if you have one): Not Applicable

F. Brief description of the Matter to which this EDS pertains. (Include project number and location of property, if applicable):

ZONING CHANGE OF 1515 WEST WALTON ST., CHICAGO, ILLINOIS

G. Which City agency or department is requesting this EDS? DEPARTMENT OF PLANNING AND DEVELOPMENT

If the Matter is a contract being handled by the City's Department of Procurement Services, please complete the following:

Specification # \_\_\_\_\_ and Contract # \_\_\_\_\_

**SECTION II -- DISCLOSURE OF OWNERSHIP INTERESTS**

**A. NATURE OF THE DISCLOSING PARTY**

1. Indicate the nature of the Disclosing Party:

- Person
- Publicly registered business corporation
- Privately held business corporation
- Sole proprietorship
- General partnership
- Limited partnership
- Trust
- Limited liability company
- Limited liability partnership
- Joint venture
- Not-for-profit corporation  
(Is the not-for-profit corporation also a 501(c)(3))?  
 Yes       No
- Other (please specify)

2. For legal entities, the state (or foreign country) of incorporation or organization, if applicable:

---

3. For legal entities not organized in the State of Illinois: Has the organization registered to do business in the State of Illinois as a foreign entity?

- Yes                       No                       Organized in Illinois

**B. IF THE DISCLOSING PARTY IS A LEGAL ENTITY:**

1. List below the full names and titles, if applicable, of: (i) all executive officers and all directors of the entity; (ii) **for not-for-profit corporations**, all members, if any, which are legal entities (if there are no such members, write "no members which are legal entities"); (iii) **for trusts, estates or other similar entities**, the trustee, executor, administrator, or similarly situated party; (iv) **for general or limited partnerships, limited liability companies, limited liability partnerships or joint ventures**, each general partner, managing member, manager or any other person or legal entity that directly or indirectly controls the day-to-day management of the Applicant.

**NOTE:** Each legal entity listed below must submit an EDS on its own behalf.

Name	Title

2. Please provide the following information concerning each person or legal entity having a direct or indirect, current or prospective (i.e. within 6 months after City action) beneficial interest (including ownership) in excess of 7.5% of the Applicant. Examples of such an interest include shares in a corporation, partnership interest in a partnership or joint venture, interest of a member or manager in a

limited liability company, or interest of a beneficiary of a trust, estate or other similar entity. If none, state "None."

**NOTE:** Each legal entity listed below may be required to submit an EDS on its own behalf.

Name	Business Address	Percentage Interest in the Applicant
------	------------------	--------------------------------------

---

---

---

**SECTION III -- INCOME OR COMPENSATION TO, OR OWNERSHIP BY, CITY ELECTED OFFICIALS**

Has the Disclosing Party provided any income or compensation to any City elected official during the 12-month period preceding the date of this EDS?  Yes  No

Does the Disclosing Party reasonably expect to provide any income or compensation to any City elected official during the 12-month period following the date of this EDS?  Yes  No

If "yes" to either of the above, please identify below the name(s) of such City elected official(s) and describe such income or compensation:

---

---

Does any City elected official or, to the best of the Disclosing Party's knowledge after reasonable inquiry, any City elected official's spouse or domestic partner, have a financial interest (as defined in Chapter 2-156 of the Municipal Code of Chicago ("MCC")) in the Disclosing Party?

Yes  No

If "yes," please identify below the name(s) of such City elected official(s) and/or spouse(s)/domestic partner(s) and describe the financial interest(s).

---

---

**SECTION IV -- DISCLOSURE OF SUBCONTRACTORS AND OTHER RETAINED PARTIES**

The Disclosing Party must disclose the name and business address of each subcontractor, attorney, lobbyist (as defined in MCC Chapter 2-156), accountant, consultant and any other person or entity whom the Disclosing Party has retained or expects to retain in connection with the Matter, as well as the nature of the relationship, and the total amount of the fees paid or estimated to be paid. The Disclosing Party is not required to disclose employees who are paid solely through the Disclosing Party's regular payroll. If the Disclosing Party is uncertain whether a disclosure is required under this Section, the Disclosing Party must either ask the City whether disclosure is required or make the disclosure.

Name (indicate whether retained or anticipated to be retained)	Business Address	Relationship to Disclosing Party (subcontractor, attorney, lobbyist, etc.)	Fees ( <u>indicate whether paid or estimated.</u> ) NOTE: "hourly rate" or "t.b.d." is not an acceptable response.
--	------------------	--	--

The Applicant, EZMB, LLC has retained Counsel.

---

(Add sheets if necessary)

Check here if the Disclosing Party has not retained, nor expects to retain, any such persons or entities.

**SECTION V -- CERTIFICATIONS**

**A. COURT-ORDERED CHILD SUPPORT COMPLIANCE**

Under MCC Section 2-92-415, substantial owners of business entities that contract with the City must remain in compliance with their child support obligations throughout the contract's term.

Has any person who directly or indirectly owns 10% or more of the Disclosing Party been declared in arrearage on any child support obligations by any Illinois court of competent jurisdiction?

Yes     No     No person directly or indirectly owns 10% or more of the Disclosing Party.

If "Yes," has the person entered into a court-approved agreement for payment of all support owed and is the person in compliance with that agreement?

Yes     No

**B. FURTHER CERTIFICATIONS**

1. [This paragraph 1 applies only if the Matter is a contract being handled by the City's Department of Procurement Services.] In the 5-year period preceding the date of this EDS, neither the Disclosing Party nor any Affiliated Entity [see definition in (5) below] has engaged, in connection with the performance of any public contract, the services of an integrity monitor, independent private sector inspector general, or integrity compliance consultant (i.e., an individual or entity with legal, auditing, investigative, or other similar skills, designated by a public agency to help the agency monitor the activity of specified agency vendors as well as help the vendors reform their business practices so they can be considered for agency contracts in the future, or continue with a contract in progress).

2. The Disclosing Party and its Affiliated Entities are not delinquent in the payment of any fine, fee, tax or other source of indebtedness owed to the City of Chicago, including, but not limited to, water and sewer charges, license fees, parking tickets, property taxes and sales taxes, nor is the Disclosing Party delinquent in the payment of any tax administered by the Illinois Department of Revenue.

3. The Disclosing Party and, if the Disclosing Party is a legal entity, all of those persons or entities identified in Section II(B)(1) of this EDS:

- a. are not presently debarred, suspended, proposed for debarment, declared ineligible or voluntarily excluded from any transactions by any federal, state or local unit of government;
- b. have not, during the 5 years before the date of this EDS, been convicted of a criminal offense, adjudged guilty, or had a civil judgment rendered against them in connection with: obtaining, attempting to obtain, or performing a public (federal, state or local) transaction or contract under a public transaction; a violation of federal or state antitrust statutes; fraud; embezzlement; theft; forgery; bribery; falsification or destruction of records; making false statements; or receiving stolen property;
- c. are not presently indicted for, or criminally or civilly charged by, a governmental entity (federal, state or local) with committing any of the offenses set forth in subparagraph (b) above;
- d. have not, during the 5 years before the date of this EDS, had one or more public transactions (federal, state or local) terminated for cause or default; and
- e. have not, during the 5 years before the date of this EDS, been convicted, adjudged guilty, or found liable in a civil proceeding, or in any criminal or civil action, including actions concerning environmental violations, instituted by the City or by the federal government, any state, or any other unit of local government.

4. The Disclosing Party understands and shall comply with the applicable requirements of MCC Chapters 2-56 (Inspector General) and 2-156 (Governmental Ethics).

5. Certifications (5), (6) and (7) concern:

- the Disclosing Party;
- any "Contractor" (meaning any contractor or subcontractor used by the Disclosing Party in connection with the Matter, including but not limited to all persons or legal entities disclosed under Section IV, "Disclosure of Subcontractors and Other Retained Parties");
- any "Affiliated Entity" (meaning a person or entity that, directly or indirectly: controls the Disclosing Party, is controlled by the Disclosing Party, or is, with the Disclosing Party, under common control of another person or entity). Indicia of control include, without limitation: interlocking management or ownership; identity of interests among family members, shared facilities and equipment; common use of employees; or organization of a business entity following the ineligibility of a business entity to do business with federal or state or local government, including the City, using substantially the same management, ownership, or principals as the ineligible entity. With respect to Contractors, the term Affiliated Entity means a person or entity that directly or indirectly controls the Contractor, is controlled by it, or, with the Contractor, is under common control of another person or entity;
- any responsible official of the Disclosing Party, any Contractor or any Affiliated Entity or any other official, agent or employee of the Disclosing Party, any Contractor or any Affiliated Entity, acting pursuant to the direction or authorization of a responsible official of the Disclosing Party, any Contractor or any Affiliated Entity (collectively "Agents").



Neither the Disclosing Party, nor any Contractor, nor any Affiliated Entity of either the Disclosing Party or any Contractor, nor any Agents have, during the 5 years before the date of this EDS, or, with respect to a Contractor, an Affiliated Entity, or an Affiliated Entity of a Contractor during the 5 years before the date of such Contractor's or Affiliated Entity's contract or engagement in connection with the Matter:

- a. bribed or attempted to bribe, or been convicted or adjudged guilty of bribery or attempting to bribe, a public officer or employee of the City, the State of Illinois, or any agency of the federal government or of any state or local government in the United States of America, in that officer's or employee's official capacity;
- b. agreed or colluded with other bidders or prospective bidders, or been a party to any such agreement, or been convicted or adjudged guilty of agreement or collusion among bidders or prospective bidders, in restraint of freedom of competition by agreement to bid a fixed price or otherwise; or
- c. made an admission of such conduct described in subparagraph (a) or (b) above that is a matter of record, but have not been prosecuted for such conduct; or
- d. violated the provisions referenced in MCC Subsection 2-92-320(a)(4)(Contracts Requiring a Base Wage); (a)(5)(Debarment Regulations); or (a)(6)(Minimum Wage Ordinance).

6. Neither the Disclosing Party, nor any Affiliated Entity or Contractor, or any of their employees, officials, agents or partners, is barred from contracting with any unit of state or local government as a result of engaging in or being convicted of (1) bid-rigging in violation of 720 ILCS 5/33E-3; (2) bid-rotating in violation of 720 ILCS 5/33E-4; or (3) any similar offense of any state or of the United States of America that contains the same elements as the offense of bid-rigging or bid-rotating.

7. Neither the Disclosing Party nor any Affiliated Entity is listed on a Sanctions List maintained by the United States Department of Commerce, State, or Treasury, or any successor federal agency.

8. [FOR APPLICANT ONLY] (i) Neither the Applicant nor any "controlling person" [see MCC Chapter 1-23, Article I for applicability and defined terms] of the Applicant is currently indicted or charged with, or has admitted guilt of, or has ever been convicted of, or placed under supervision for, any criminal offense involving actual, attempted, or conspiracy to commit bribery, theft, fraud, forgery, perjury, dishonesty or deceit against an officer or employee of the City or any "sister agency"; and (ii) the Applicant understands and acknowledges that compliance with Article I is a continuing requirement for doing business with the City. NOTE: If MCC Chapter 1-23, Article I applies to the Applicant, that Article's permanent compliance timeframe supersedes 5-year compliance timeframes in this Section V.

9. [FOR APPLICANT ONLY] The Applicant and its Affiliated Entities will not use, nor permit their subcontractors to use, any facility listed as having an active exclusion by the U.S. EPA on the federal System for Award Management ("SAM").

10. [FOR APPLICANT ONLY] The Applicant will obtain from any contractors/subcontractors hired or to be hired in connection with the Matter certifications equal in form and substance to those in Certifications (2) and (9) above and will not, without the prior written consent of the City, use any such

contractor/subcontractor that does not provide such certifications or that the Applicant has reason to believe has not provided or cannot provide truthful certifications.

11. If the Disclosing Party is unable to certify to any of the above statements in this Part B (Further Certifications), the Disclosing Party must explain below:

N/A

---

---

---

If the letters "NA," the word "None," or no response appears on the lines above, it will be conclusively presumed that the Disclosing Party certified to the above statements.

12. To the best of the Disclosing Party's knowledge after reasonable inquiry, the following is a complete list of all current employees of the Disclosing Party who were, at any time during the 12-month period preceding the date of this EDS, an employee, or elected or appointed official, of the City of Chicago (if none, indicate with "N/A" or "none").

N/A

---

---

---

13. To the best of the Disclosing Party's knowledge after reasonable inquiry, the following is a complete list of all gifts that the Disclosing Party has given or caused to be given, at any time during the 12-month period preceding the execution date of this EDS, to an employee, or elected or appointed official, of the City of Chicago. For purposes of this statement, a "gift" does not include: (i) anything made generally available to City employees or to the general public, or (ii) food or drink provided in the course of official City business and having a retail value of less than \$25 per recipient, or (iii) a political contribution otherwise duly reported as required by law (if none, indicate with "N/A" or "none"). As to any gift listed below, please also list the name of the City recipient.

N/A

---

---

---

**C. CERTIFICATION OF STATUS AS FINANCIAL INSTITUTION**

1. The Disclosing Party certifies that the Disclosing Party (check one)

is  is not

a "financial institution" as defined in MCC Section 2-32-455(b).

2. If the Disclosing Party IS a financial institution, then the Disclosing Party pledges:

"We are not and will not become a predatory lender as defined in MCC Chapter 2-32. We further pledge that none of our affiliates is, and none of them will become, a predatory lender as defined in MCC Chapter 2-32. We understand that becoming a predatory lender or becoming an affiliate of a predatory lender may result in the loss of the privilege of doing business with the City."

If the Disclosing Party is unable to make this pledge because it or any of its affiliates (as defined in MCC Section 2-32-455(b)) is a predatory lender within the meaning of MCC Chapter 2-32, explain here (attach additional pages if necessary):

N/A

---

If the letters "NA," the word "None," or no response appears on the lines above, it will be conclusively presumed that the Disclosing Party certified to the above statements.

**D. CERTIFICATION REGARDING FINANCIAL INTEREST IN CITY BUSINESS**

Any words or terms defined in MCC Chapter 2-156 have the same meanings if used in this Part D.

1. In accordance with MCC Section 2-156-110: To the best of the Disclosing Party's knowledge after reasonable inquiry, does any official or employee of the City have a financial interest in his or her own name or in the name of any other person or entity in the Matter?

Yes                       No

NOTE: If you checked "Yes" to Item D(1), proceed to Items D(2) and D(3). If you checked "No" to Item D(1), skip Items D(2) and D(3) and proceed to Part E.

2. Unless sold pursuant to a process of competitive bidding, or otherwise permitted, no City elected official or employee shall have a financial interest in his or her own name or in the name of any other person or entity in the purchase of any property that (i) belongs to the City, or (ii) is sold for taxes or assessments, or (iii) is sold by virtue of legal process at the suit of the City (collectively, "City Property Sale"). Compensation for property taken pursuant to the City's eminent domain power does not constitute a financial interest within the meaning of this Part D.

Does the Matter involve a City Property Sale?

Yes                       No

3. If you checked "Yes" to Item D(1), provide the names and business addresses of the City officials or employees having such financial interest and identify the nature of the financial interest:

Name	Business Address	Nature of Financial Interest
<hr/>		
<hr/>		
<hr/>		

4. The Disclosing Party further certifies that no prohibited financial interest in the Matter will be acquired by any City official or employee.

E. CERTIFICATION REGARDING SLAVERY ERA BUSINESS

Please check either (1) or (2) below. If the Disclosing Party checks (2), the Disclosing Party must disclose below or in an attachment to this EDS all information required by (2). Failure to comply with these disclosure requirements may make any contract entered into with the City in connection with the Matter voidable by the City.

X 1. The Disclosing Party verifies that the Disclosing Party has searched any and all records of the Disclosing Party and any and all predecessor entities regarding records of investments or profits from slavery or slaveholder insurance policies during the slavery era (including insurance policies issued to slaveholders that provided coverage for damage to or injury or death of their slaves), and the Disclosing Party has found no such records.

\_\_\_ 2. The Disclosing Party verifies that, as a result of conducting the search in step (1) above, the Disclosing Party has found records of investments or profits from slavery or slaveholder insurance policies. The Disclosing Party verifies that the following constitutes full disclosure of all such records, including the names of any and all slaves or slaveholders described in those records:

---

---

---

SECTION VI -- CERTIFICATIONS FOR FEDERALLY FUNDED MATTERS

**NOTE: If the Matter is federally funded, complete this Section VI. If the Matter is not federally funded, proceed to Section VII. For purposes of this Section VI, tax credits allocated by the City and proceeds of debt obligations of the City are not federal funding.**

A. CERTIFICATION REGARDING LOBBYING

1. List below the names of all persons or entities registered under the federal Lobbying Disclosure Act of 1995, as amended, who have made lobbying contacts on behalf of the Disclosing Party with respect to the Matter: (Add sheets if necessary):

---

---

---

(If no explanation appears or begins on the lines above, or if the letters "NA" or if the word "None" appear, it will be conclusively presumed that the Disclosing Party means that NO persons or entities registered under the Lobbying Disclosure Act of 1995, as amended, have made lobbying contacts on behalf of the Disclosing Party with respect to the Matter.)

2. The Disclosing Party has not spent and will not expend any federally appropriated funds to pay any person or entity listed in paragraph A(1) above for his or her lobbying activities or to pay any person or entity to influence or attempt to influence an officer or employee of any agency, as defined by applicable federal law, a member of Congress, an officer or employee of Congress, or an employee

of a member of Congress, in connection with the award of any federally funded contract, making any federally funded grant or loan, entering into any cooperative agreement, or to extend, continue, renew, amend, or modify any federally funded contract, grant, loan, or cooperative agreement.

3. The Disclosing Party will submit an updated certification at the end of each calendar quarter in which there occurs any event that materially affects the accuracy of the statements and information set forth in paragraphs A(1) and A(2) above.

4. The Disclosing Party certifies that either: (i) it is not an organization described in section 501(c)(4) of the Internal Revenue Code of 1986; or (ii) it is an organization described in section 501(c)(4) of the Internal Revenue Code of 1986 but has not engaged and will not engage in "Lobbying Activities," as that term is defined in the Lobbying Disclosure Act of 1995, as amended.

5. If the Disclosing Party is the Applicant, the Disclosing Party must obtain certifications equal in form and substance to paragraphs A(1) through A(4) above from all subcontractors before it awards any subcontract and the Disclosing Party must maintain all such subcontractors' certifications for the duration of the Matter and must make such certifications promptly available to the City upon request.

#### B. CERTIFICATION REGARDING EQUAL EMPLOYMENT OPPORTUNITY

If the Matter is federally funded, federal regulations require the Applicant and all proposed subcontractors to submit the following information with their bids or in writing at the outset of negotiations.

Is the Disclosing Party the Applicant?

Yes                       No

If "Yes," answer the three questions below:

1. Have you developed and do you have on file affirmative action programs pursuant to applicable federal regulations? (See 41 CFR Part 60-2.)

Yes                       No

2. Have you filed with the Joint Reporting Committee, the Director of the Office of Federal Contract Compliance Programs, or the Equal Employment Opportunity Commission all reports due under the applicable filing requirements?

Yes                       No                       Reports not required

3. Have you participated in any previous contracts or subcontracts subject to the equal opportunity clause?

Yes                       No

If you checked "No" to question (1) or (2) above, please provide an explanation:

---

---

## SECTION VII -- FURTHER ACKNOWLEDGMENTS AND CERTIFICATION

The Disclosing Party understands and agrees that:

A. The certifications, disclosures, and acknowledgments contained in this EDS will become part of any contract or other agreement between the Applicant and the City in connection with the Matter, whether procurement, City assistance, or other City action, and are material inducements to the City's execution of any contract or taking other action with respect to the Matter. The Disclosing Party understands that it must comply with all statutes, ordinances, and regulations on which this EDS is based.

B. The City's Governmental Ethics Ordinance, MCC Chapter 2-156, imposes certain duties and obligations on persons or entities seeking City contracts, work, business, or transactions. The full text of this ordinance and a training program is available on line at [www.cityofchicago.org/Ethics](http://www.cityofchicago.org/Ethics), and may also be obtained from the City's Board of Ethics, 740 N. Sedgwick St., Suite 500, Chicago, IL 60610, (312) 744-9660. The Disclosing Party must comply fully with this ordinance.

C. If the City determines that any information provided in this EDS is false, incomplete or inaccurate, any contract or other agreement in connection with which it is submitted may be rescinded or be void or voidable, and the City may pursue any remedies under the contract or agreement (if not rescinded or void), at law, or in equity, including terminating the Disclosing Party's participation in the Matter and/or declining to allow the Disclosing Party to participate in other City transactions. Remedies at law for a false statement of material fact may include incarceration and an award to the City of treble damages.

D. It is the City's policy to make this document available to the public on its Internet site and/or upon request. Some or all of the information provided in, and appended to, this EDS may be made publicly available on the Internet, in response to a Freedom of Information Act request, or otherwise. By completing and signing this EDS, the Disclosing Party waives and releases any possible rights or claims which it may have against the City in connection with the public release of information contained in this EDS and also authorizes the City to verify the accuracy of any information submitted in this EDS.

E. The information provided in this EDS must be kept current. In the event of changes, the Disclosing Party must supplement this EDS up to the time the City takes action on the Matter. If the Matter is a contract being handled by the City's Department of Procurement Services, the Disclosing Party must update this EDS as the contract requires. **NOTE:** With respect to Matters subject to MCC Chapter 1-23, Article I (imposing **PERMANENT INELIGIBILITY** for certain specified offenses), the information provided herein regarding eligibility must be kept current for a longer period, as required by MCC Chapter 1-23 and Section 2-154-020.

**CERTIFICATION**

Under penalty of perjury, the person signing below: (1) warrants that he/she is authorized to execute this EDS, and Appendices A and B (if applicable), on behalf of the Disclosing Party, and (2) warrants that all certifications and statements contained in this EDS, and Appendices A and B (if applicable), are true, accurate and complete as of the date furnished to the City.

Cirilo Garcia a/k/a Cirilo Camacho Garcia  
(Print or type exact legal name of Disclosing Party)

By: Cirilo Garcia Camacho  
(Sign here)

Cirilo Garcia a/k/a Cirilo Camacho Garcia  
(Print or type name of person signing)

Owner of 1515 W. Walton St.  
(Print or type title of person signing)

Signed and sworn to before me on (date) August 22, 2017,

at COOK County, ILLINOIS (state).

[Signature]  
Notary Public

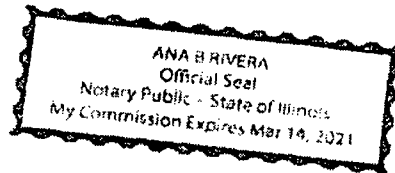

Commission expires: 3/14/21

**CITY OF CHICAGO  
ECONOMIC DISCLOSURE STATEMENT AND AFFIDAVIT  
APPENDIX A**

**FAMILIAL RELATIONSHIPS WITH ELECTED CITY OFFICIALS  
AND DEPARTMENT HEADS**

**This Appendix is to be completed only by (a) the Applicant, and (b) any legal entity which has a direct ownership interest in the Applicant exceeding 7.5%. It is not to be completed by any legal entity which has only an indirect ownership interest in the Applicant.**

Under MCC Section 2-154-015, the Disclosing Party must disclose whether such Disclosing Party or any "Applicable Party" or any Spouse or Domestic Partner thereof currently has a "familial relationship" with any elected city official or department head. A "familial relationship" exists if, as of the date this EDS is signed, the Disclosing Party or any "Applicable Party" or any Spouse or Domestic Partner thereof is related to the mayor, any alderman, the city clerk, the city treasurer or any city department head as spouse or domestic partner or as any of the following, whether by blood or adoption: parent, child, brother or sister, aunt or uncle, niece or nephew, grandparent, grandchild, father-in-law, mother-in-law, son-in-law, daughter-in-law, stepfather or stepmother, stepson or stepdaughter, stepbrother or stepsister or half-brother or half-sister.

"Applicable Party" means (1) all executive officers of the Disclosing Party listed in Section II.B.1.a., if the Disclosing Party is a corporation; all partners of the Disclosing Party, if the Disclosing Party is a general partnership; all general partners and limited partners of the Disclosing Party, if the Disclosing Party is a limited partnership; all managers, managing members and members of the Disclosing Party, if the Disclosing Party is a limited liability company; (2) all principal officers of the Disclosing Party; and (3) any person having more than a 7.5% ownership interest in the Disclosing Party. "Principal officers" means the president, chief operating officer, executive director, chief financial officer, treasurer or secretary of a legal entity or any person exercising similar authority.

Does the Disclosing Party or any "Applicable Party" or any Spouse or Domestic Partner thereof currently have a "familial relationship" with an elected city official or department head?

Yes

No

If yes, please identify below (1) the name and title of such person, (2) the name of the legal entity to which such person is connected; (3) the name and title of the elected city official or department head to whom such person has a familial relationship, and (4) the precise nature of such familial relationship.

---

---

---



**CITY OF CHICAGO  
ECONOMIC DISCLOSURE STATEMENT AND AFFIDAVIT  
APPENDIX B**

**BUILDING CODE SCOFFLAW/PROBLEM LANDLORD CERTIFICATION**

This Appendix is to be completed only by (a) the Applicant, and (b) any legal entity which has a direct ownership interest in the Applicant exceeding 7.5% (an "Owner"). It is not to be completed by any legal entity which has only an indirect ownership interest in the Applicant.

1. Pursuant to MCC Section 2-154-010, is the Applicant or any Owner identified as a building code scofflaw or problem landlord pursuant to MCC Section 2-92-416?

Yes                       No

2. If the Applicant is a legal entity publicly traded on any exchange, is any officer or director of the Applicant identified as a building code scofflaw or problem landlord pursuant to MCC Section 2-92-416?

Yes                       No                       The Applicant is not publicly traded on any exchange.

3. If yes to (1) or (2) above, please identify below the name of each person or legal entity identified as a building code scofflaw or problem landlord and the address of each building or buildings to which the pertinent code violations apply.

---

---

---

**CITY OF CHICAGO  
ECONOMIC DISCLOSURE STATEMENT  
AND AFFIDAVIT**

**SECTION I -- GENERAL INFORMATION**

A. Legal name of the Disclosing Party submitting this EDS. Include d/b/a/ if applicable:

Vincenta Hernandez Garcia

---

**Check ONE of the following three boxes:**

Indicate whether the Disclosing Party submitting this EDS is:

1.  The Owner of 1515 W. Walton

OR

2.  a legal entity currently holding, or anticipated to hold within six months after City action on the contract, transaction or other undertaking to which this EDS pertains (referred to below as the "Matter"), a direct or indirect interest in excess of 7.5% in the Applicant. State the Applicant's legal name: \_\_\_\_\_

OR

3.  a legal entity with a direct or indirect right of control of the Applicant (see Section II(B)(1)) State the legal name of the entity in which the Disclosing Party holds a right of control: \_\_\_\_\_

B. Business address of the Disclosing Party: 1515 W. Walton St.  
Chicago, IL 60642

C. Telephone: \_\_\_\_\_ Fax: n/a Email: n/a

D. Name of contact person: Michael A. Perez, Esq.

E. Federal Employer Identification No. (if you have one): Not Applicable

F. Brief description of the Matter to which this EDS pertains. (Include project number and location of property, if applicable):

ZONING CHANGE OF 1515 WEST WALTON ST., CHICAGO, ILLINOIS

G. Which City agency or department is requesting this EDS? DEPARTMENT OF PLANNING AND DEVELOPMENT

If the Matter is a contract being handled by the City's Department of Procurement Services, please complete the following:

Specification # \_\_\_\_\_ and Contract # \_\_\_\_\_

**SECTION II -- DISCLOSURE OF OWNERSHIP INTERESTS**

**A. NATURE OF THE DISCLOSING PARTY**

1. Indicate the nature of the Disclosing Party:

- |   |  |
|---|--|
| <input checked="" type="checkbox"/> Person                        | <input type="checkbox"/> Limited liability company       |
| <input type="checkbox"/> Publicly registered business corporation | <input type="checkbox"/> Limited liability partnership   |
| <input type="checkbox"/> Privately held business corporation      | <input type="checkbox"/> Joint venture                   |
| <input type="checkbox"/> Sole proprietorship                      | <input type="checkbox"/> Not-for-profit corporation      |
| <input type="checkbox"/> General partnership                      | (Is the not-for-profit corporation also a 501(c)(3))?    |
| <input type="checkbox"/> Limited partnership                      | <input type="checkbox"/> Yes <input type="checkbox"/> No |
| <input type="checkbox"/> Trust                                    | <input type="checkbox"/> Other (please specify)          |
- 

2. For legal entities, the state (or foreign country) of incorporation or organization, if applicable:

---

3. For legal entities not organized in the State of Illinois: Has the organization registered to do business in the State of Illinois as a foreign entity?

- Yes  No  Organized in Illinois

**B. IF THE DISCLOSING PARTY IS A LEGAL ENTITY:**

1. List below the full names and titles, if applicable, of: (i) all executive officers and all directors of the entity; (ii) **for not-for-profit corporations**, all members, if any, which are legal entities (if there are no such members, write "no members which are legal entities"); (iii) **for trusts, estates or other similar entities**, the trustee, executor, administrator, or similarly situated party; (iv) **for general or limited partnerships, limited liability companies, limited liability partnerships or joint ventures**, each general partner, managing member, manager or any other person or legal entity that directly or indirectly controls the day-to-day management of the Applicant.

**NOTE:** Each legal entity listed below must submit an EDS on its own behalf.

Name	Title
------	-------

---

---

---

2. Please provide the following information concerning each person or legal entity having a direct or indirect, current or prospective (i.e. within 6 months after City action) beneficial interest (including ownership) in excess of 7.5% of the Applicant. Examples of such an interest include shares in a corporation, partnership interest in a partnership or joint venture, interest of a member or manager in a

limited liability company, or interest of a beneficiary of a trust, estate or other similar entity. If none, state "None."

**NOTE:** Each legal entity listed below may be required to submit an EDS on its own behalf.

Name	Business Address	Percentage Interest in the Applicant

**SECTION III -- INCOME OR COMPENSATION TO, OR OWNERSHIP BY, CITY ELECTED OFFICIALS**

Has the Disclosing Party provided any income or compensation to any City elected official during the 12-month period preceding the date of this EDS?  Yes  No

Does the Disclosing Party reasonably expect to provide any income or compensation to any City elected official during the 12-month period following the date of this EDS?  Yes  No

If "yes" to either of the above, please identify below the name(s) of such City elected official(s) and describe such income or compensation:

---

---

Does any City elected official or, to the best of the Disclosing Party's knowledge after reasonable inquiry, any City elected official's spouse or domestic partner, have a financial interest (as defined in Chapter 2-156 of the Municipal Code of Chicago ("MCC")) in the Disclosing Party?  Yes  No

If "yes," please identify below the name(s) of such City elected official(s) and/or spouse(s)/domestic partner(s) and describe the financial interest(s).

---

---

**SECTION IV -- DISCLOSURE OF SUBCONTRACTORS AND OTHER RETAINED PARTIES**

The Disclosing Party must disclose the name and business address of each subcontractor, attorney, lobbyist (as defined in MCC Chapter 2-156), accountant, consultant and any other person or entity whom the Disclosing Party has retained or expects to retain in connection with the Matter, as well as the nature of the relationship, and the total amount of the fees paid or estimated to be paid. The Disclosing Party is not required to disclose employees who are paid solely through the Disclosing Party's regular payroll. If the Disclosing Party is uncertain whether a disclosure is required under this Section, the Disclosing Party must either ask the City whether disclosure is required or make the disclosure.

Name (indicate whether retained or anticipated to be retained)	Business Address	Relationship to Disclosing Party (subcontractor, attorney, lobbyist, etc.)	Fees ( <u>indicate whether paid or estimated.</u> ) NOTE: "hourly rate" or "t.b.d." is not an acceptable response.
--	------------------	--	--

The Applicant, EZMB, LLC has retained Counsel.

---



---

(Add sheets if necessary)

Check here if the Disclosing Party has not retained, nor expects to retain, any such persons or entities.

**SECTION V -- CERTIFICATIONS**

**A. COURT-ORDERED CHILD SUPPORT COMPLIANCE**

Under MCC Section 2-92-415, substantial owners of business entities that contract with the City must remain in compliance with their child support obligations throughout the contract's term.

Has any person who directly or indirectly owns 10% or more of the Disclosing Party been declared in arrearage on any child support obligations by any Illinois court of competent jurisdiction?

Yes     No     No person directly or indirectly owns 10% or more of the Disclosing Party.

If "Yes," has the person entered into a court-approved agreement for payment of all support owed and is the person in compliance with that agreement?

Yes     No

**B. FURTHER CERTIFICATIONS**

1. [This paragraph 1 applies only if the Matter is a contract being handled by the City's Department of Procurement Services.] In the 5-year period preceding the date of this EDS, neither the Disclosing Party nor any Affiliated Entity [see definition in (5) below] has engaged, in connection with the performance of any public contract, the services of an integrity monitor, independent private sector inspector general, or integrity compliance consultant (i.e., an individual or entity with legal, auditing, investigative, or other similar skills, designated by a public agency to help the agency monitor the activity of specified agency vendors as well as help the vendors reform their business practices so they can be considered for agency contracts in the future, or continue with a contract in progress).

2. The Disclosing Party and its Affiliated Entities are not delinquent in the payment of any fine, fee, tax or other source of indebtedness owed to the City of Chicago, including, but not limited to, water and sewer charges, license fees, parking tickets, property taxes and sales taxes, nor is the Disclosing Party delinquent in the payment of any tax administered by the Illinois Department of Revenue.

3. The Disclosing Party and, if the Disclosing Party is a legal entity, all of those persons or entities identified in Section II(B)(1) of this EDS:
- a. are not presently debarred, suspended, proposed for debarment, declared ineligible or voluntarily excluded from any transactions by any federal, state or local unit of government;
  - b. have not, during the 5 years before the date of this EDS, been convicted of a criminal offense, adjudged guilty, or had a civil judgment rendered against them in connection with: obtaining, attempting to obtain, or performing a public (federal, state or local) transaction or contract under a public transaction; a violation of federal or state antitrust statutes; fraud; embezzlement; theft; forgery; bribery; falsification or destruction of records; making false statements; or receiving stolen property;
  - c. are not presently indicted for, or criminally or civilly charged by, a governmental entity (federal, state or local) with committing any of the offenses set forth in subparagraph (b) above;
  - d. have not, during the 5 years before the date of this EDS, had one or more public transactions (federal, state or local) terminated for cause or default; and
  - e. have not, during the 5 years before the date of this EDS, been convicted, adjudged guilty, or found liable in a civil proceeding, or in any criminal or civil action, including actions concerning environmental violations, instituted by the City or by the federal government, any state, or any other unit of local government.
4. The Disclosing Party understands and shall comply with the applicable requirements of MCC Chapters 2-56 (Inspector General) and 2-156 (Governmental Ethics).
5. Certifications (5), (6) and (7) concern:
- the Disclosing Party;
  - any "Contractor" (meaning any contractor or subcontractor used by the Disclosing Party in connection with the Matter, including but not limited to all persons or legal entities disclosed under Section IV, "Disclosure of Subcontractors and Other Retained Parties");
  - any "Affiliated Entity" (meaning a person or entity that, directly or indirectly: controls the Disclosing Party, is controlled by the Disclosing Party, or is, with the Disclosing Party, under common control of another person or entity). Indicia of control include, without limitation: interlocking management or ownership; identity of interests among family members, shared facilities and equipment; common use of employees; or organization of a business entity following the ineligibility of a business entity to do business with federal or state or local government, including the City, using substantially the same management, ownership, or principals as the ineligible entity. With respect to Contractors, the term Affiliated Entity means a person or entity that directly or indirectly controls the Contractor, is controlled by it, or, with the Contractor, is under common control of another person or entity;
  - any responsible official of the Disclosing Party, any Contractor or any Affiliated Entity or any other official, agent or employee of the Disclosing Party, any Contractor or any Affiliated Entity, acting pursuant to the direction or authorization of a responsible official of the Disclosing Party, any Contractor or any Affiliated Entity (collectively "Agents").

Neither the Disclosing Party, nor any Contractor, nor any Affiliated Entity of either the Disclosing Party or any Contractor, nor any Agents have, during the 5 years before the date of this EDS, or, with respect to a Contractor, an Affiliated Entity, or an Affiliated Entity of a Contractor during the 5 years before the date of such Contractor's or Affiliated Entity's contract or engagement in connection with the Matter:

- a. bribed or attempted to bribe, or been convicted or adjudged guilty of bribery or attempting to bribe, a public officer or employee of the City, the State of Illinois, or any agency of the federal government or of any state or local government in the United States of America, in that officer's or employee's official capacity;
  - b. agreed or colluded with other bidders or prospective bidders, or been a party to any such agreement, or been convicted or adjudged guilty of agreement or collusion among bidders or prospective bidders, in restraint of freedom of competition by agreement to bid a fixed price or otherwise; or
  - c. made an admission of such conduct described in subparagraph (a) or (b) above that is a matter of record, but have not been prosecuted for such conduct; or
  - d. violated the provisions referenced in MCC Subsection 2-92-320(a)(4)(Contracts Requiring a Base Wage); (a)(5)(Debarment Regulations); or (a)(6)(Minimum Wage Ordinance).
6. Neither the Disclosing Party, nor any Affiliated Entity or Contractor, or any of their employees, officials, agents or partners, is barred from contracting with any unit of state or local government as a result of engaging in or being convicted of (1) bid-rigging in violation of 720 ILCS 5/33E-3; (2) bid-rotating in violation of 720 ILCS 5/33E-4; or (3) any similar offense of any state or of the United States of America that contains the same elements as the offense of bid-rigging or bid-rotating.
7. Neither the Disclosing Party nor any Affiliated Entity is listed on a Sanctions List maintained by the United States Department of Commerce, State, or Treasury, or any successor federal agency.
8. [FOR APPLICANT ONLY] (i) Neither the Applicant nor any "controlling person" [see MCC Chapter 1-23, Article I for applicability and defined terms] of the Applicant is currently indicted or charged with, or has admitted guilt of, or has ever been convicted of, or placed under supervision for, any criminal offense involving actual, attempted, or conspiracy to commit bribery, theft, fraud, forgery, perjury, dishonesty or deceit against an officer or employee of the City or any "sister agency"; and (ii) the Applicant understands and acknowledges that compliance with Article I is a continuing requirement for doing business with the City. NOTE: If MCC Chapter 1-23, Article I applies to the Applicant, that Article's permanent compliance timeframe supersedes 5-year compliance timeframes in this Section V.
9. [FOR APPLICANT ONLY] The Applicant and its Affiliated Entities will not use, nor permit their subcontractors to use, any facility listed as having an active exclusion by the U.S. EPA on the federal System for Award Management ("SAM").
10. [FOR APPLICANT ONLY] The Applicant will obtain from any contractors/subcontractors hired or to be hired in connection with the Matter certifications equal in form and substance to those in Certifications (2) and (9) above and will not, without the prior written consent of the City, use any such

contractor/subcontractor that does not provide such certifications or that the Applicant has reason to believe has not provided or cannot provide truthful certifications.

11. If the Disclosing Party is unable to certify to any of the above statements in this Part B (Further Certifications), the Disclosing Party must explain below:

N/A

---

---

---

If the letters "NA," the word "None," or no response appears on the lines above, it will be conclusively presumed that the Disclosing Party certified to the above statements.

12. To the best of the Disclosing Party's knowledge after reasonable inquiry, the following is a complete list of all current employees of the Disclosing Party who were, at any time during the 12-month period preceding the date of this EDS, an employee, or elected or appointed official, of the City of Chicago (if none, indicate with "N/A" or "none").

N/A

---

---

---

13. To the best of the Disclosing Party's knowledge after reasonable inquiry, the following is a complete list of all gifts that the Disclosing Party has given or caused to be given, at any time during the 12-month period preceding the execution date of this EDS, to an employee, or elected or appointed official, of the City of Chicago. For purposes of this statement, a "gift" does not include: (i) anything made generally available to City employees or to the general public, or (ii) food or drink provided in the course of official City business and having a retail value of less than \$25 per recipient, or (iii) a political contribution otherwise duly reported as required by law (if none, indicate with "N/A" or "none"). As to any gift listed below, please also list the name of the City recipient.

N/A

---

---

---

### C. CERTIFICATION OF STATUS AS FINANCIAL INSTITUTION

1. The Disclosing Party certifies that the Disclosing Party (check one)

is  is not

a "financial institution" as defined in MCC Section 2-32-455(b).

2. If the Disclosing Party IS a financial institution, then the Disclosing Party pledges:

"We are not and will not become a predatory lender as defined in MCC Chapter 2-32. We further pledge that none of our affiliates is, and none of them will become, a predatory lender as defined in MCC Chapter 2-32. We understand that becoming a predatory lender or becoming an affiliate of a predatory lender may result in the loss of the privilege of doing business with the City."



If the Disclosing Party is unable to make this pledge because it or any of its affiliates (as defined in MCC Section 2-32-455(b)) is a predatory lender within the meaning of MCC Chapter 2-32, explain here (attach additional pages if necessary):

N/A

If the letters "NA," the word "None," or no response appears on the lines above, it will be conclusively presumed that the Disclosing Party certified to the above statements.

**D. CERTIFICATION REGARDING FINANCIAL INTEREST IN CITY BUSINESS**

Any words or terms defined in MCC Chapter 2-156 have the same meanings if used in this Part D.

1. In accordance with MCC Section 2-156-110: To the best of the Disclosing Party's knowledge after reasonable inquiry, does any official or employee of the City have a financial interest in his or her own name or in the name of any other person or entity in the Matter?

Yes

No

NOTE: If you checked "Yes" to Item D(1), proceed to Items D(2) and D(3). If you checked "No" to Item D(1), skip Items D(2) and D(3) and proceed to Part E.

2. Unless sold pursuant to a process of competitive bidding, or otherwise permitted, no City elected official or employee shall have a financial interest in his or her own name or in the name of any other person or entity in the purchase of any property that (i) belongs to the City, or (ii) is sold for taxes or assessments, or (iii) is sold by virtue of legal process at the suit of the City (collectively, "City Property Sale"). Compensation for property taken pursuant to the City's eminent domain power does not constitute a financial interest within the meaning of this Part D.

Does the Matter involve a City Property Sale?

Yes

No

3. If you checked "Yes" to Item D(1), provide the names and business addresses of the City officials or employees having such financial interest and identify the nature of the financial interest:

Name	Business Address	Nature of Financial Interest

4. The Disclosing Party further certifies that no prohibited financial interest in the Matter will be acquired by any City official or employee.

E. CERTIFICATION REGARDING SLAVERY ERA BUSINESS

Please check either (1) or (2) below. If the Disclosing Party checks (2), the Disclosing Party must disclose below or in an attachment to this EDS all information required by (2). Failure to comply with these disclosure requirements may make any contract entered into with the City in connection with the Matter voidable by the City.

X 1. The Disclosing Party verifies that the Disclosing Party has searched any and all records of the Disclosing Party and any and all predecessor entities regarding records of investments or profits from slavery or slaveholder insurance policies during the slavery era (including insurance policies issued to slaveholders that provided coverage for damage to or injury or death of their slaves), and the Disclosing Party has found no such records.

2. The Disclosing Party verifies that, as a result of conducting the search in step (1) above, the Disclosing Party has found records of investments or profits from slavery or slaveholder insurance policies. The Disclosing Party verifies that the following constitutes full disclosure of all such records, including the names of any and all slaves or slaveholders described in those records:

---

---

---

**SECTION VI -- CERTIFICATIONS FOR FEDERALLY FUNDED MATTERS**

**NOTE: If the Matter is federally funded, complete this Section VI. If the Matter is not federally funded, proceed to Section VII. For purposes of this Section VI, tax credits allocated by the City and proceeds of debt obligations of the City are not federal funding.**

A. CERTIFICATION REGARDING LOBBYING

1. List below the names of all persons or entities registered under the federal Lobbying Disclosure Act of 1995, as amended, who have made lobbying contacts on behalf of the Disclosing Party with respect to the Matter: (Add sheets if necessary):

---

---

---

(If no explanation appears or begins on the lines above, or if the letters "NA" or if the word "None" appear, it will be conclusively presumed that the Disclosing Party means that NO persons or entities registered under the Lobbying Disclosure Act of 1995, as amended, have made lobbying contacts on behalf of the Disclosing Party with respect to the Matter.)

2. The Disclosing Party has not spent and will not expend any federally appropriated funds to pay any person or entity listed in paragraph A(1) above for his or her lobbying activities or to pay any person or entity to influence or attempt to influence an officer or employee of any agency, as defined by applicable federal law, a member of Congress, an officer or employee of Congress, or an employee

of a member of Congress, in connection with the award of any federally funded contract, making any federally funded grant or loan, entering into any cooperative agreement, or to extend, continue, renew, amend, or modify any federally funded contract, grant, loan, or cooperative agreement.

3. The Disclosing Party will submit an updated certification at the end of each calendar quarter in which there occurs any event that materially affects the accuracy of the statements and information set forth in paragraphs A(1) and A(2) above.

4. The Disclosing Party certifies that either: (i) it is not an organization described in section 501(c)(4) of the Internal Revenue Code of 1986; or (ii) it is an organization described in section 501(c)(4) of the Internal Revenue Code of 1986 but has not engaged and will not engage in "Lobbying Activities," as that term is defined in the Lobbying Disclosure Act of 1995, as amended.

5. If the Disclosing Party is the Applicant, the Disclosing Party must obtain certifications equal in form and substance to paragraphs A(1) through A(4) above from all subcontractors before it awards any subcontract and the Disclosing Party must maintain all such subcontractors' certifications for the duration of the Matter and must make such certifications promptly available to the City upon request.

#### B. CERTIFICATION REGARDING EQUAL EMPLOYMENT OPPORTUNITY

If the Matter is federally funded, federal regulations require the Applicant and all proposed subcontractors to submit the following information with their bids or in writing at the outset of negotiations.

Is the Disclosing Party the Applicant?

Yes  No

If "Yes," answer the three questions below:

1. Have you developed and do you have on file affirmative action programs pursuant to applicable federal regulations? (See 41 CFR Part 60-2.)

Yes  No

2. Have you filed with the Joint Reporting Committee, the Director of the Office of Federal Contract Compliance Programs, or the Equal Employment Opportunity Commission all reports due under the applicable filing requirements?

Yes  No  Reports not required

3. Have you participated in any previous contracts or subcontracts subject to the equal opportunity clause?

Yes  No

If you checked "No" to question (1) or (2) above, please provide an explanation:

---

---

## SECTION VII -- FURTHER ACKNOWLEDGMENTS AND CERTIFICATION

The Disclosing Party understands and agrees that:

- A. The certifications, disclosures, and acknowledgments contained in this EDS will become part of any contract or other agreement between the Applicant and the City in connection with the Matter, whether procurement, City assistance, or other City action, and are material inducements to the City's execution of any contract or taking other action with respect to the Matter. The Disclosing Party understands that it must comply with all statutes, ordinances, and regulations on which this EDS is based.
- B. The City's Governmental Ethics Ordinance, MCC Chapter 2-156, imposes certain duties and obligations on persons or entities seeking City contracts, work, business, or transactions. The full text of this ordinance and a training program is available on line at [www.cityofchicago.org/Ethics](http://www.cityofchicago.org/Ethics), and may also be obtained from the City's Board of Ethics, 740 N. Sedgwick St., Suite 500, Chicago, IL 60610, (312) 744-9660. The Disclosing Party must comply fully with this ordinance.
- C. If the City determines that any information provided in this EDS is false, incomplete or inaccurate, any contract or other agreement in connection with which it is submitted may be rescinded or be void or voidable, and the City may pursue any remedies under the contract or agreement (if not rescinded or void), at law, or in equity, including terminating the Disclosing Party's participation in the Matter and/or declining to allow the Disclosing Party to participate in other City transactions. Remedies at law for a false statement of material fact may include incarceration and an award to the City of treble damages.
- D. It is the City's policy to make this document available to the public on its Internet site and/or upon request. Some or all of the information provided in, and appended to, this EDS may be made publicly available on the Internet, in response to a Freedom of Information Act request, or otherwise. By completing and signing this EDS, the Disclosing Party waives and releases any possible rights or claims which it may have against the City in connection with the public release of information contained in this EDS and also authorizes the City to verify the accuracy of any information submitted in this EDS.
- E. The information provided in this EDS must be kept current. In the event of changes, the Disclosing Party must supplement this EDS up to the time the City takes action on the Matter. If the Matter is a contract being handled by the City's Department of Procurement Services, the Disclosing Party must update this EDS as the contract requires. **NOTE:** With respect to Matters subject to MCC Chapter 1-23, Article I (imposing **PERMANENT INELIGIBILITY** for certain specified offenses), the information provided herein regarding eligibility must be kept current for a longer period, as required by MCC Chapter 1-23 and Section 2-154-020.

**CERTIFICATION**

Under penalty of perjury, the person signing below: (1) warrants that he/she is authorized to execute this EDS, and Appendices A and B (if applicable), on behalf of the Disclosing Party, and (2) warrants that all certifications and statements contained in this EDS, and Appendices A and B (if applicable), are true, accurate and complete as of the date furnished to the City.

Vincenta Hernandez Garcia

(Print or type exact legal name of Disclosing Party)

By: Vincenta Hernandez Garcia  
(Sign here)

Vincenta Hernandez Garcia

(Print or type name of person signing)

Owner of 1515 W. Walton St.

(Print or type title of person signing)

Signed and sworn to before me on (date) August 22, 2017,

at COOK County, ILLINOIS (state).

[Signature]  
Notary Public

Commission expires: 3/14/21

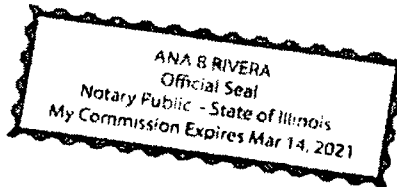

**CITY OF CHICAGO  
ECONOMIC DISCLOSURE STATEMENT AND AFFIDAVIT  
APPENDIX A**

**FAMILIAL RELATIONSHIPS WITH ELECTED CITY OFFICIALS  
AND DEPARTMENT HEADS**

**This Appendix is to be completed only by (a) the Applicant, and (b) any legal entity which has a direct ownership interest in the Applicant exceeding 7.5%. It is not to be completed by any legal entity which has only an indirect ownership interest in the Applicant.**

Under MCC Section 2-154-015, the Disclosing Party must disclose whether such Disclosing Party or any "Applicable Party" or any Spouse or Domestic Partner thereof currently has a "familial relationship" with any elected city official or department head. A "familial relationship" exists if, as of the date this EDS is signed, the Disclosing Party or any "Applicable Party" or any Spouse or Domestic Partner thereof is related to the mayor, any alderman, the city clerk, the city treasurer or any city department head as spouse or domestic partner or as any of the following, whether by blood or adoption: parent, child, brother or sister, aunt or uncle, niece or nephew, grandparent, grandchild, father-in-law, mother-in-law, son-in-law, daughter-in-law, stepfather or stepmother, stepson or stepdaughter, stepbrother or stepsister or half-brother or half-sister.

"Applicable Party" means (1) all executive officers of the Disclosing Party listed in Section II.B.1.a., if the Disclosing Party is a corporation; all partners of the Disclosing Party, if the Disclosing Party is a general partnership; all general partners and limited partners of the Disclosing Party, if the Disclosing Party is a limited partnership; all managers, managing members and members of the Disclosing Party, if the Disclosing Party is a limited liability company; (2) all principal officers of the Disclosing Party; and (3) any person having more than a 7.5% ownership interest in the Disclosing Party. "Principal officers" means the president, chief operating officer, executive director, chief financial officer, treasurer or secretary of a legal entity or any person exercising similar authority.

Does the Disclosing Party or any "Applicable Party" or any Spouse or Domestic Partner thereof currently have a "familial relationship" with an elected city official or department head?

Yes

No

If yes, please identify below (1) the name and title of such person, (2) the name of the legal entity to which such person is connected; (3) the name and title of the elected city official or department head to whom such person has a familial relationship, and (4) the precise nature of such familial relationship.

---

---

---

**CITY OF CHICAGO  
ECONOMIC DISCLOSURE STATEMENT AND AFFIDAVIT  
APPENDIX B**

**BUILDING CODE SCOFFLAW/PROBLEM LANDLORD CERTIFICATION**

This Appendix is to be completed only by (a) the Applicant, and (b) any legal entity which has a direct ownership interest in the Applicant exceeding 7.5% (an "Owner"). It is not to be completed by any legal entity which has only an indirect ownership interest in the Applicant.

1. Pursuant to MCC Section 2-154-010, is the Applicant or any Owner identified as a building code scofflaw or problem landlord pursuant to MCC Section 2-92-416?

Yes                       No

2. If the Applicant is a legal entity publicly traded on any exchange, is any officer or director of the Applicant identified as a building code scofflaw or problem landlord pursuant to MCC Section 2-92-416?

Yes                       No                       The Applicant is not publicly traded on any exchange.

3. If yes to (1) or (2) above, please identify below the name of each person or legal entity identified as a building code scofflaw or problem landlord and the address of each building or buildings to which the pertinent code violations apply.

---

---

---