



# City of Chicago



Or2018-359

Office of the City Clerk

## Document Tracking Sheet

<b>Meeting Date:</b>	7/25/2018
<b>Sponsor(s):</b>	Reilly (42)
<b>Type:</b>	Order
<b>Title:</b>	Issuance of permits for sign(s)/signboard(s) at 125 W Ohio St
<b>Committee(s) Assignment:</b>	Committee on Zoning, Landmarks and Building Standards

CITY COUNCIL  
COMMITTEE ON ZONING, LANDMARKS AND BUILDING STANDARDS

COUNCIL ORDER

RE: Approval of sign over 100 square feet in area or over 24 feet above grade

ORDERED, that the City Council hereby approves the following sign application submitted by:

Applicant\*: BW River North Hotel

(\* The Applicant is the owner of the real property or the business tenant of the real property. Do not list the sign contractor, sign erector, sign company or advertising entity in the above space.)

This Order approves the following sign in accordance with Municipal Code of Chicago Section 13-20-680;

Address of Sign: 125 W. Ohio Street Chicago, IL 60654

Zoning District: DX-7

DOB Sign Permit Application #: 100770421

Sign Details:

1. On-premise  OR Off-premise
2. Static sign  OR Dynamic-image display sign
3. Number of sign faces 1
4. Projecting over the public way Yes (Yes or No) If yes, Public Way Use #: 1134693
5. Dimensions: Length 3 feet 11 inches Height 68 feet 8 inches  
Total square feet in area: 269 feet 0 inches
6. Height above grade: 25 feet 0 inches
7. Elevation (side of building or lot where the sign will be erected): West
8. Name of Sign Contractor/Erector: Volkan Signs & Lighting Inc.

To be legal, such sign shall comply with all provisions of Title 17 of the Chicago Municipal Code ("Zoning Ordinance") and all other provisions of the Municipal Code governing the permitting, construction and maintenance and removal of signs and sign structures. Failure of the applicant and the applicant's successors to comply shall be grounds for invalidation or revocation of the sign permit.

  
Alderman

42

Ward

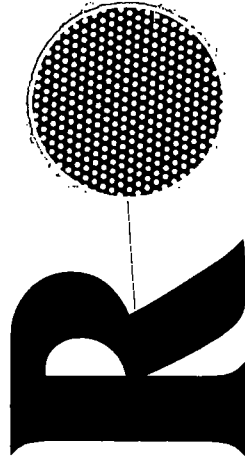

- Black aluminum returns
  - 3/16" White 7328 acrylic face c/w Blue 3m DN00402 perforated vinyl applied to 1st surface
  - 1" Best Western Blue firm cap
  - "GE" White LED illumination
- Pattern required

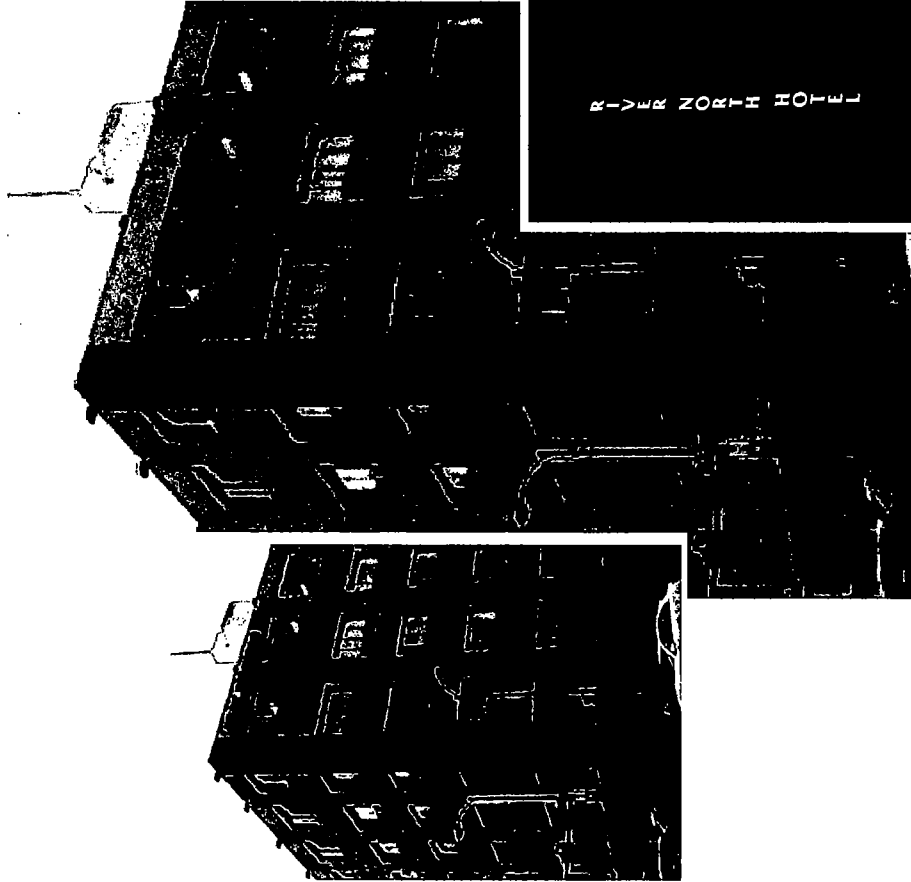

Night View

**Electrical Requirements**  
120V

Graphic reproducing representation of subject artwork. Colors and materials shown are approximate and subject to change without notice. All materials and finishes are subject to availability and change without notice. All materials and finishes are subject to availability and change without notice.

**SITE CHECK REQUIRED.**

Preliminary Artwork  
Approved for Production

**CLIENT APPROVAL**  
**REVISION DATES:**  
July 27, 2017  
B.H.



DRAWN BY: B. Hardy  
DATE: April 3, 2017

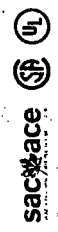

BW -RF014112.120A1  
SHEET # 1 OF 1

**BILL OF MATERIALS**

REF.#	DESCRIPTION	QTY	LENGTH
1	.063" ALUMINUM ROUTED LED BACKER	12	
2	GOG-3 LED MODULE	806	
3	60W-12V POWER SUPPLY	15	
4	1.5A SWITCH SET-SP	15	
5	3/8" LIQUID TIGHT LEAD w 1/4" WIRE	15	14'-0"

\*\*\* LED CENTRES ARE TIGHTENED TO 4 1/2" TO INCREASE ILLUMINATION THROUGH PERFORATED VINYL ON FACES  
\* LED QTY'S SHOWN BELOW

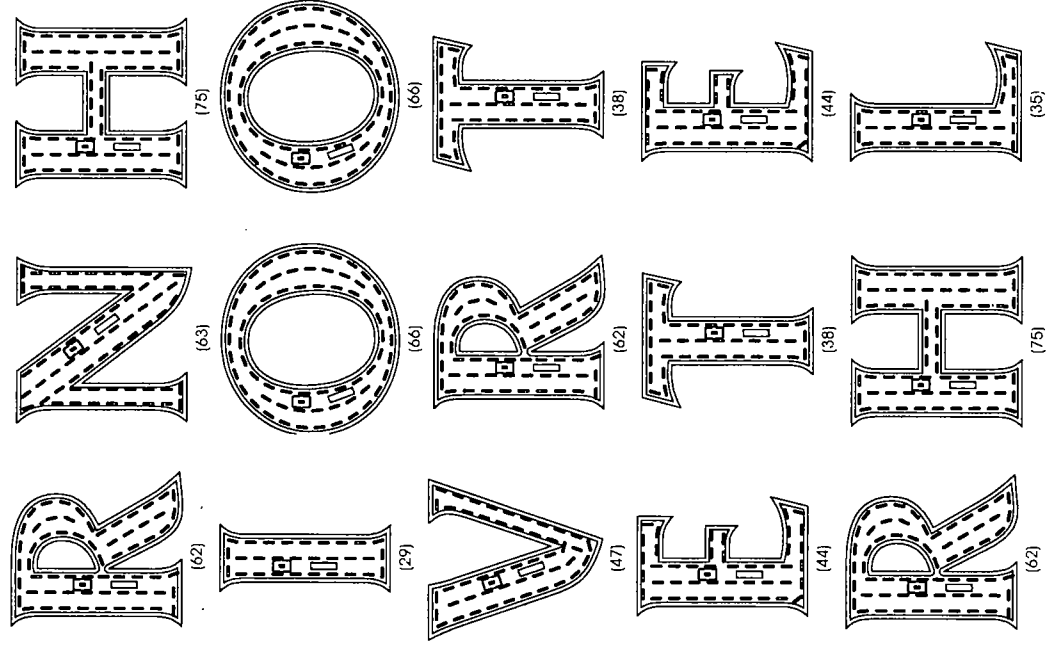

TYP. LED LAYOUT

SIGN TYPE: CHANNEL LETTER RETRO FIT  
OVERALL SIZE: 3'-6" X 68'-7" 5/8"  
TOTAL LETTER AREA: 91 SQ. FT.  
TOTAL WEIGHT: 280 LBS.  
AMPERE/VOLTAGE LOAD: 18A @ 120V  
BRANCH CIRCUITS REQ'D: (2) 15A CIRCUITS  
ILLUMINATION TYPE: LED  
TOTAL WAITS: 580W  
POWER SUPPLY: 60W-12V DRAWS MAX 1.2A EACH

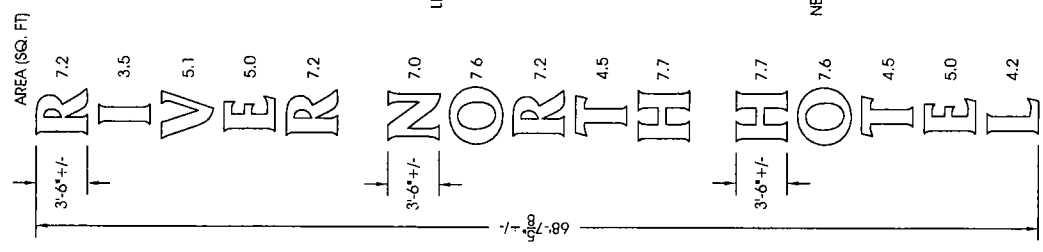
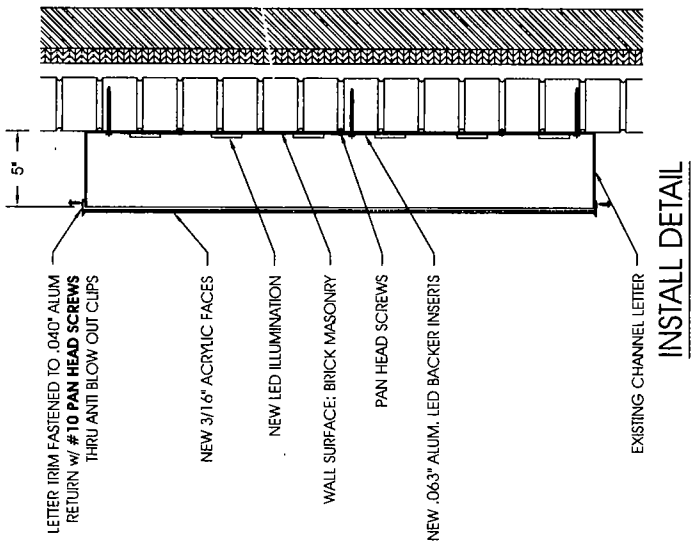
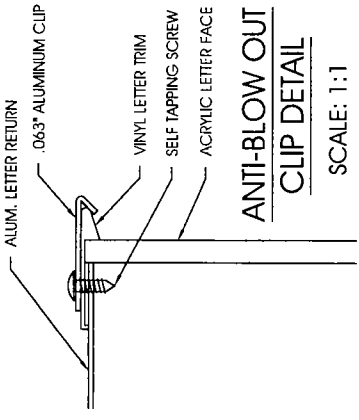

REVISION	DATE	BY	DESCRIPTION
01	21-NOV-17	SP	ADDED ELECTRICAL DETAILS
00	02-AUG-17	FB	RELEASED FOR PERMIT

BEST WESTERN  
125 WEST OHIO STREET  
CHICAGO, IL 60654-7168

**NEW LETTER FACES & LED RETROFIT**

AMP DRAW - 18A @ 120V

**PRIDE SIGNS, INC.**  
THE STRUCTURAL DRAWINGS IS THE PROPERTY OF PRIDE SIGNS LIMITED AND MAY NOT BE USED IN WHOLE OR PART WITHOUT THE WRITTEN CONSENT FROM PRIDE SIGNS LIMITED © 2017  
245 PINEBUSH ROAD, CAMBRIDGE, ON, CANADA N1T 1E7 - TEL: 519.422.4400 - WWW.PRIDESIGNS.COM