



City of Chicago



SO2020-94

Office of the City Clerk

Document Tracking Sheet

Meeting Date: 1/15/2020

Sponsor(s): Misc. Transmittal

Type: Ordinance

Title: Zoning Reclassification Map No. 1-E at 421-451 N Michigan Ave, 137-209 E Illinois St and 458-478 Cityfront Plaza Dr - App No. 20323

Committee(s) Assignment: Committee on Zoning, Landmarks and Building Standards

#20323
Intro date
JAN. 15, 2020

ORDINANCE

BE IT ORDAINED BY THE CITY COUNCIL OF THE CITY OF CHICAGO:

SECTION 1: That the Chicago Zoning Ordinance be amended by changing all DX-16 Downtown Mixed-Use District and DX-12 Downtown Mixed-Use District symbols and designations as shown on Map No. 1-E in the area bounded by

Illinois Street; Cityfront Plaza Drive; North Water Street and Michigan Avenue,

to the designation of the DX-12 Downtown Mixed-Use District and a corresponding use district is hereby established in the area above described.

SECTION 2: That the Chicago Zoning Ordinance be amended by changing all DX-12 Downtown Mixed-Use District symbols and designations as shown on Map No. 1-E in the area bounded by

Illinois Street; Cityfront Plaza Drive; North Water Street and Michigan Avenue,

to the designation of a Residential Business Planned Development, which is hereby established in the area above described, subject to such use and bulk regulations as are set forth in the Plan of Development herewith attached and made a part thereof and to no others.

SECTION 3: This Ordinance shall be in force and effect from and after its passage and due publication.

Address: 421-51 N. Michigan Ave.; 137-209 E. Illinois St.; and 458-78 N. Cityfront Plaza Dr.

PLANNED DEVELOPMENT STATEMENTS

1. The area delineated herein as Planned Development Number _____, (Planned Development) consists of approximately 132,241 square feet of property which is depicted on the attached Planned Development Boundary and Property Line Map (Property) and is owned or controlled by the Applicant, Tribune Tower East (Chicago) Owner, LLC.
2. The requirements, obligations and conditions contained within this Planned Development shall be binding upon the Applicant, its successors and assigns and, if different than the Applicant, the legal title holders and any ground lessors. All rights granted hereunder to the Applicant shall inure to the benefit of the Applicant's successors and assigns and, if different than the Applicant, the legal title holder and any ground lessors. Furthermore, pursuant to the requirements of Section 17-8-0400 of the Chicago Zoning Ordinance, the Property, at the time of application for amendments, modifications or changes (administrative, legislative or otherwise) to this Planned Development are made, shall be under single ownership or designated control. Single designated control is defined in Section 17-8-0400.
3. All applicable official reviews, approvals or permits are required to be obtained by the Applicant or its successors, assignees or grantees. Any dedication or vacation of streets or alleys or grants of easements or any adjustment of the right-of-way shall require a separate submittal to the Department of Transportation on behalf of the Applicant or its successors, assignees or grantees.

Any requests for grants of privilege, or any items encroaching on the public way, shall be in compliance with the Planned Development.

Ingress or egress shall be pursuant to the Planned Development and may be subject to the review and approval of the Departments of Planning and Development and Transportation. Closure of all or any public street or alley during demolition or construction shall be subject to the review and approval of the Department of Transportation.

Pursuant to the traffic study for this Planned Development approved by the Department of Transportation, the following improvements will be implemented at the Applicant's expense:

- Provide a lower-level lobby and curbside zone for the East Parcel access road for drop-off/pick-up activity serving the hotel and residential uses
 - Promote use of lower-level streets to distribute traffic loads
 - Provide off-street drop-off/pick-up zone that does not impact public street travel lanes
- Increase signage to orient TNC pick-ups to the lower level. Promote use of the lower level for passenger pick-up and limit traffic on the upper level.
- Post minor-leg stop control at the following new intersections:
 - East Parcel Lower-Level Alley/East Parcel Garage Access
 - Lower North Water Street/East Parcel Lower-Level Alley
 - Lower North Water Street/West Parcel Garage Access

Applicant	Tribune Tower East (Chicago) Owner, LLC
Address	412-51 N. Michigan Ave., 137-209 E. Illinois & 458-78 N. Cityfront Plaza Dr.
Introduced	January 15, 2020
Plan Commission	May 8, 2020

Lower Illinois/St. Clair Street:

- Modify the existing signal at the Lower Illinois Street/St. Clair Street intersection to incorporate a south leg for the East Parcel access.

Grand Avenue/St. Clair Street:

- Modify the evening peak hour signal timings to shift three (3) seconds of green time from the westbound phase to the north-south phase.
- Install pedestrian countdown signals at the following intersections:
 - Lower Michigan Avenue/Lower Illinois Street
 - Lower Michigan Avenue/Grand Avenue
- Install/restripe international-style crosswalks at:
 - Upper Michigan Avenue/Upper Illinois Street
 - Lower Michigan Avenue/Lower North Water Street
 - Lower Michigan Avenue/Grand Avenue (south leg only)
 - Lower Illinois Street/Lower Cityfront Plaza Drive
 - Lower North Water Street/Lower Cityfront Plaza Drive
 - Lower Illinois Street/St. Clair Street (west leg)
 - Signalized mid-block crossings on Upper Michigan Avenue at Tribune Tower and Pioneer Court

Upper-Level Illinois Street:

- Coordinate with the Alderman's office to remove/relocate current loading and consulate parking zones along the south side of Illinois Street adjacent to the East and West Parcels prior to installation of the layby lane on Upper Illinois.

Upper-Level Michigan Avenue/Illinois Street:

- Shorten the pedestrian walk time by approximately six (6) seconds and provide lagging northbound green phase on Michigan Avenue.

Upper-Level Illinois Street/Cityfront Plaza Drive:

- Reconfigure the traffic circle into a "T" intersection and provide access for a drop-off/pick-up zone serving the property north of the intersection.

Cityfront Plaza Drive:

- Relocation of the existing Divvy station subject to the approval of the Divvy Program Director.

Pursuant to a negotiated and executed Perimeter Restoration Agreement ("Agreement") by and between the Department of Transportation's Division of Infrastructure Management and the Applicant, the Applicant shall provide improvements and restoration of all public way adjacent to the property, which may include, but not be limited to, the following as shall be reviewed and determined by the Department of Transportation's Division of Infrastructure Management:

- Full width of streets
- Full width of alleys
- Curb and gutter
- Pavement markings

Applicant:	Tribune Tower East (Chicago) Owner, LLC
Address:	412-51 N Michigan Ave , 137-209 E Illinois & 458-78 N Cityfront Plaza Dr
Introduced:	January 15, 2020
Plan Commission:	May 8, 2020

- Sidewalks
- ADA crosswalk ramps
- Parkway and landscaping

The Perimeter Restoration Agreement must be executed prior to any Department of Transportation and Planned Development Part II review permitting. The Agreement shall reflect that all work must comply with current Rules and Regulations and must be designed and constructed in accordance with the Department of Transportation's Construction Standards for work in the Public Way and in compliance with the Municipal Code of Chicago Chapter 10-20. Design of said improvements should follow the Department of Transportation's Rules and Regulations for Construction in the Public Way as well as The Street and Site Plan Design Guidelines. Any variation in scope or design of public way improvements and restoration must be approved by the Department of Transportation.

4. This Plan of Development consists of 18 Statements: a Bulk Regulations Table; an Existing Zoning Map; an Existing Land-Use Map; a Planned Development Boundary and Property Line Map; Site Plan; Sub-Area Map; Floor Plans (typical, if applicable); Landscape Plan; a Green Roof Plan; and, Building Elevations (North, South, East and West) prepared by Solomon Cordwell Buenz and Adrian Smith + Gordon Gill Architecture dated May 8, 2020, submitted herein. Full-sized copies of the Site Plan, Landscape Plan and Building Elevations are on file with the Department of Planning and Development. In any instance where a provision of this Planned Development conflicts with the Chicago Building Code, the Building Code shall control. This Planned Development conforms to the intent and purpose of the Chicago Zoning Ordinance, and all requirements thereto, and satisfies the established criteria for approval as a Planned Development. In case of a conflict between the terms of this Planned Development Ordinance and the Chicago Zoning Ordinance, this Planned Development shall control.

5. In each of the following Sub Areas, the following uses shall be permitted in this Planned Development:

Sub-Area A: dwelling units located above the ground floor; colleges and universities; eating and drinking establishment (all); entertainment and spectator sports (all, except inter-track wagering facility); financial services; food and beverage retail sales; office; general retail sales; accessory parking and loading; co-located wireless communications facilities; and related and ancillary uses.

Sub-Area B: dwelling units located above the ground floor; colleges and universities; eating and drinking establishment (all); entertainment and spectator sports (all, except inter-track wagering facility); financial services; food and beverage retail sales; lodging; office; general retail sales; accessory parking and loading; co-located wireless communications facilities; and related and ancillary uses.

Applicant	Tribune Tower East (Chicago) Owner, LLC
Address	412-51 N Michigan Ave 157-209 E. Illinois & 458-78 N Cityfront Plaza Dr
Introduced	January 15, 2020
Plan Commission	May 8, 2020

Sub-Area C: plaza; eating and drinking establishment (all); outdoor patio; food and beverage retail sales; general retail sales; accessory parking and loading; and related and ancillary uses.

6. On-Premise signs and temporary signs, such as construction and marketing signs, shall be permitted within the Planned Development, subject to the review and approval of the Department of Planning and Development. Off-Premise signs are prohibited within the boundary of the Planned Development.
7. For purposes of height measurement, the definitions in the Chicago Zoning Ordinance shall apply. The height of any building shall also be subject to height limitations, if any, established by the Federal Aviation Administration.
8. The maximum permitted floor area ratio (FAR) for the Property shall be in accordance with the attached Bulk Regulations and Data Table. For the purpose of FAR calculations and measurements, the definitions in the Zoning Ordinance shall apply. The permitted FAR identified in the Bulk Regulations and Data Table has been determined using a net site area of 132,241 square feet and a base FAR of 12. FAR may be transferred from one subarea to another subarea administratively, pursuant to Section 17-13-0611-A, by the Zoning Administrator upon the application for such a modification by the Applicant, its successors and assigns and, if different than the Applicant, the legal title holders and any ground lessors.

The Applicant acknowledges that the project has received bonus FAR of 3.31 totaling 437,608 square feet, pursuant to Sec. 17-4-1000 of the Zoning Ordinance. With this bonus FAR, the total FAR for the Planned Development is 15.31. In exchange for the bonus FAR, the Applicant is required to make a corresponding payment, pursuant to Sections 17-4-1003-B & C, prior to the issuance of the first building permit for any buildings in Sub-Areas B or C of the Planned Development; provided, however, if the Planned Development is constructed in phases, the bonus payment may be paid on a pro rata basis as the first building permit for each subsequent new building or phase of construction is issued. The bonus payment will be recalculated at the time of payment (including partial payments for phased developments) and may be adjusted based on changes in median land values in accordance with Section 17-4-1003-C.3.

The bonus payment will be split between three separate funds, as follows: 80% to the Neighborhoods Opportunity Fund, 10% to the Citywide Adopt-a-Landmark Fund and 10% to the Local Impact Fund. In lieu of paying the City directly, the Department may: (a) direct developers to deposit a portion of the funds with a sister agency to finance specific local improvement projects; (b) direct developers to deposit a portion of the funds with a landmark property owner to finance specific landmark restoration projects; or, (c) approve proposals for in-kind improvements to satisfy the Local Impact portion of the payment.

9. Upon review and determination, Part II Review, pursuant to Section 17-13-0610, a Part II Review Fee shall be assessed by the Department of Planning and Development. The fee, as

Applicant:	Tribune Tower East (Chicago) Owner, LLC
Address:	412-51 N. Michigan Ave., 137-209 E. Illinois & 458-78 N. Cityfront Plaza Dr.
Introduced:	January 15, 2020
Plan Commission	May 8, 2020

determined by staff at the time, is final and binding on the Applicant and must be paid to the Department of Revenue prior to the issuance of any Part II approval.

10. The Site and Landscape Plans shall be in substantial conformance with the Landscape Ordinance and any other corresponding regulations and guidelines, including Section 17-13-0800. Final landscape plan review and approval will be by the Department of Planning and Development. Any interim reviews associated with site plan review or Part II reviews, are conditional until final Part II approval.

The Applicant or its successors or assignees agrees to construct the proposed landscaping improvements as shown on the Site and Landscape Plans for Pioneer Court. The landscaping of Pioneer Court is required to be substantially completed prior to issuance of final certificate of occupancy for the building located within Sub-Area B, provided that planting may be delayed, if consistent with good landscape practice, but no longer than one year following receipt of the occupancy certificate. Pioneer Court shall be maintained in accordance with that certain existing Pioneer Maintenance Agreement dated December 18, 1986, and recorded with the Cook County Recorder of Deeds as document numbered 87106321. The Applicant or its successors or assignees agrees to be responsible for the cost of the maintaining the portion of Pioneer Court located with planned development in accordance that the sharing agreement to be enter into with the adjacent 401 N. Michigan Avenuc property owner.

11. The Applicant shall comply with Rules and Regulations for the Maintenance of Stockpiles promulgated by the Commissioners of the Departments of Streets and Sanitation, Fleet and Facility Management and Buildings, under Section 13-32-085, or any other provision of the Municipal Code of Chicago.
12. The terms and conditions of development under this Planned Development ordinance may be modified administratively, pursuant to Section 17-13-0611-A, by the Zoning Administrator upon the application for such a modification by the Applicant, its successors and assigns and, if different than the Applicant, the legal title holders and any ground lessors.
13. The Applicant acknowledges that it is in the public interest to design, construct and maintain the project in a manner which promotes, enables and maximizes universal access throughout the Property. Plans for all buildings and improvements on the Property shall be reviewed and approved by the Mayor's Office for People with Disabilities to ensure compliance with all applicable laws and regulations related to access for persons with disabilities and to promote the highest standard of accessibility.
14. The Applicant acknowledges that it is in the public interest to design, construct, renovate and maintain all buildings in a manner that provides healthier indoor environments, reduces operating costs and conserves energy and natural resources. The Applicant shall obtain the number of points necessary to meet the requirements of the Chicago Sustainable Development Policy, in effect at the time the Part II review process is initiated for each

Applicant.	Tribune Tower East (Chicago) Owner, LLC
Address	412-51 N Michigan Ave . 137-209 E Illinois & 458-78 N Cityfront Plaza Dr
Introduced	January 15, 2020
Plan Commission.	May 8, 2020

improvement that is subject to the aforementioned Policy and must provide documentation verifying compliance.

15. The Applicant acknowledges that it is the policy of the City to maximize opportunities for Minority and Women-owned Business Enterprises (“M/WBEs”) and city residents to compete for contracts and jobs on construction projects approved through the planned development process. To assist the city in promoting and tracking such M/WBE and city resident participation, an applicant for planned development approval shall provide information at three points in the city approval process. First, the applicant must submit to DPD, as part of its application for planned development approval, an M/WBE Participation Proposal. The M/WBE Participation Proposal must identify the applicant’s goals for participation of certified M/WBE firms in the design, engineering and construction of the project, and of city residents in the construction work. The city encourages goals of 26% MBE and 6% WBE participation (measured against the total construction budget for the project or any phase thereof), and (ii) 50% city resident hiring (measured against the total construction work hours for the project or any phase thereof). The M/WBE Participation Proposal must include a description of the Applicant’s proposed outreach plan designed to inform M/WBEs and city residents of job and contracting opportunities. Second, at the time of the Applicant’s submission for Part II permit review for the project or any phase thereof, the Applicant must submit to DPD (a) updates (if any) to the Applicant’s preliminary outreach plan, (b) a description of the Applicant’s outreach efforts and evidence of such outreach, including, without limitation, copies of certified letters to M/WBE contractor associations and the ward office of the alderman in which the project is located and receipts thereof; (c) responses to the Applicant’s outreach efforts, and (d) updates (if any) to the applicant’s M/WBE and city resident participation goals. Third, prior to issuance of a Certificate of Occupancy for the project or any phase thereof, the Applicant must provide DPD with the actual level of M/WBE and city resident participation in the project or any phase thereof, and evidence of such participation. In addition to the forgoing, DPD may request such additional information as the department determines may be necessary or useful in evaluating the extent to which M/WBEs and city residents are informed of and utilized in planned development projects. All such information will be provided in a form acceptable to the Zoning Administrator. DPD will report the data it collects regarding projected and actual employment of M/WBEs and city residents in planned development projects twice yearly to the Chicago Plan Commission and annually to the Chicago City Council and the Mayor.
16. Pursuant to the Chicago Zoning Ordinance (Section 17-8-0911), a Planned Development gives priority to the preservation and adaptive reuse of Chicago Landmark buildings. This Planned Development (PD) includes the Tribune Tower, portions of which have been designated as a Chicago Landmark. Work to designated Chicago Landmarks is subject to the review and approval of the Commission on Chicago Landmarks pursuant to the Chicago Landmarks Ordinance, Section 2-120-740. Although not a landmarked element of the Tribune Tower, the Applicant agrees to preserve and maintain the existing “Chicago Tribune” letters as an architectural artifact within the PD. As an architectural artifact, the “Chicago Tribune” letters shall not be considered signage as defined or measured under the

Applicant	Tribune Tower East (Chicago) Owner, LLC
Address	412-51 N Michigan Ave 137-209 E Illinois & 458-78 N Cityfront Plaza Dr
Introduced	January 15, 2020
Plan Commission	May 8, 2020

Chicago Zoning Ordinance. During renovations to the non-Landmarked buildings within Sub-Area A, the Applicant shall remove, salvage and restore the existing “Chicago Tribune” letters for reuse and reinstallation generally in the same location from where they were removed. Prior to reinstallation, the original letters will be restored with an integrated lighting element that traces the back edge outline of the original letters with a ribbon of light. This lighting element preserves the historical and architectural significance of the original letters. The restored letters shall be reinstalled and mounted on a new trellis structure on the new 7th level amenity terrace providing south views looking below and through the “Chicago Tribune” letters.

17. The Applicant acknowledges and agrees that the rezoning of the Property from DX-12 and DX-16 to this Planned Development, triggers the requirements of Section 2-44-080 of the Municipal Code (the “Affordable Requirements Ordinance” or “ARO”). Any developer of a “residential housing project” within the meaning of the ARO must: (i) set aside 10% of the housing units in the residential housing project (“ARO Units”) as affordable units, or with the approval of the commissioner of the Department of Housing (“DOH”), provide the ARO Units in an approved off-site location; (ii) pay a fee in lieu of the development of the ARO Units (“Cash Payment”); or (iii) any combination of (i) and (ii); provided, however, residential housing projects in higher income areas (rental or for sale) and downtown districts (rental only) with 20 or more units must provide at least 25% of the ARO Units on-site or off-site (“Required Units”). If the developer elects to provide ARO Units off-site, the off-site ARO Units must be located within a two-mile radius from the residential housing project and in the same or a different higher income area or downtown district. This Planned Development is located in a “downtown district” within the meaning of the ARO and has a total of 726 units comprised of 287 for sale units and 439 rental units. As a result, the Applicant’s affordable housing obligation is 73 ARO Units (10% of 726 rounded up) comprised of 29 for sale ARO Units and 44 rental ARO Units, 11 of which are Required Units (25% of 44). Applicant has agreed to satisfy its for sale affordable housing obligation by making a cash payment to the Affordable Housing Opportunity Fund in the amount of \$238,340 per unit, as adjusted annually in accordance with the ARO, as set forth in the For Sale Affordable Housing Profile Form attached hereto. Applicant has agreed to satisfy its rental affordable housing obligation by making a cash payment to the Affordable Housing Opportunity Fund in the amount of \$185,376 per unit, as adjusted annually, for 33 ARO Units, and providing the remaining 11 Required Units in the rental building to be constructed in the Planned Development, as set forth in the Rental Affordable Housing Profile Form attached hereto. The Applicant agrees that the rental ARO Units must be affordable to households earning no more than 60% of the Chicago Primary Metropolitan Statistical Area Median Income (“AMI”), as updated annually by the City of Chicago. If the Applicant subsequently reduces (or increases) the number of rental or for sale housing units in the Planned Development, the Applicant shall update and resubmit the Affordable Housing Profile Form to DOH for review and approval, and DOH may adjust the requirements to reflect any such change without amending the Planned Development. Prior to the issuance of any building permits for any residential building in the Planned Development, including, without limitation, excavation or foundation permits, the Applicant must make the required

Applicant.	Tribune Tower East (Chicago) Owner, L.L.C
Address	412-51 N. Michigan Ave. 137-209 E. Illinois & 458-78 N. Cityfront Plaza Dr
Introduced.	January 15, 2020
Plan Commission	May 8, 2020

Cash Payment and/or execute and record an affordable housing agreement in accordance with Section 2-44-080(L). The Cash Payment will be recalculated at the time of payment (including partial payments for phased developments) and adjusted based on changes in the consumer price index in accordance with Section 2-44-080. The terms of the affordable housing agreement and any amendments thereto are incorporated herein by this reference. The Applicant acknowledges and agrees that the affordable housing agreement will be recorded against the Planned Development, or the applicable portion thereof, and will constitute a lien against such property. The commissioner of DOH may enforce remedies for any breach of this Statement 17, including any breach of any affordable housing agreement, and enter into settlement agreements with respect to any such breach, subject to the approval of the Corporation Counsel, without amending the Planned Development.

18. This Planned Development shall be governed by Section 17-13-0612. Should this Planned Development ordinance lapse, the Commissioner of the Department of Planning and Development shall initiate a Zoning Map Amendment to rezone Sub-Areas A and C of the property to the DX-16 zoning district and Sub-Area B of the property to the DX-12 zoning district.

Applicant	Tribune Tower East (Chicago) Owner, LLC
Address	412-51 N Michigan Ave , 137-209 E Illinois & 458-78 N Cityfront Plaza Dr
Introduced	January 15, 2020
Plan Commission	May 8, 2020

ARO Affordable Housing Profile Form (AHP)

Submit this form for projects that are subject to the 2015 ARO, Near North/Near West Pilot, Milwaukee Pilot or Pilsen/Little Village Pilot Ordinances (all projects submitted to City Council after October 13, 2015). More information is online at www.cityofchicago.gov/ARO. Submit the completed to the Department of Housing (DOH), 121 N LaSalle Street, 10th Floor, Chicago, IL 60602. **E-mail: denise.roman@cityofchicago.org or justin.root@cityofchicago.org.** Applications that include off-site units should submit documentation listed on page two.

Date: March 25, 2020

DEVELOPMENT INFORMATION

Development Name: Tribune Tower East

Development Address: 201-09 E. Illinois and 458-78 N. Cityfront Plaza Drive

Zoning Application Number, if applicable: 20323

Ward: 42

If you are working with a Planner at the City, what is his/her name? Noah Szafraniec

Type of City Involvement
check all that apply

City Land

Planned Development (PD)

Financial Assistance

Transit Served Location (TSL) project

Zoning increase

REQUIRED ATTACHMENTS: the AHP will not be reviewed until all required docs are received

ARO Web Form completed and attached - or submitted online on

ARO "Affordable Unit Details and Square Footage" worksheet completed and attached (*Excel*)

If ARO units proposed, Dimensioned Floor Plans with affordable units highlighted are attached (*pdf*)

If ARO units proposed are off-site, required attachments are included (see next page)

If ARO units are CHA/Authorized Agency units, signed acceptance letter is attached (*pdf*)

DEVELOPER INFORMATION

Developer Name Tribune Tower East (Chicago) Owner, LLC

Developer Contact Lee Golub

Developer Address 625 N. Michigan Ave., Suite 2000, Chicago, IL 60611

Email lgolub@goco.com

Developer Phone 312-440-8701

Attorney Name John J. George

Attorney Phone 312-870-8022

TIMING

Estimated date marketing will begin 4th QTR 2021

Estimated date of building permit* 4th QTR 2022

Estimated date ARO units will be complete 4th QTR 2025

*the in-lieu fee, recorded covenant and \$5,000 per unit administration fee (for off-site units) are required prior to the issuance of any building permits, including the foundation permit.

PROPOSED UNITS MEET REQUIREMENTS (to be executed by Developer & ARO Project Manager)

Developer or their agent

Date

3/31/2020

4/3/2020

Justin Root or Denise Roman, DOH

Date



ARO Web Form

Applicant Contact Information

Name: Lee Golub

Email: lgolub@goco.com

Development Information**Address**

Printed Date: 04/03/2020

Number From: 421 Number To: 451 Direction: N

Street Name: Michigan Postal Code: 60611

Development Name

Tribune Tower East

Are you rezoning to downtown?: No

Is your project subject to the ARO Pilots?: 2015 ARO REQUIREMENTS APPLY

Information

Ward: 42

ARO Zone: Downtown

Details

ARO trigger: DP

Total units 439

Development type: Rent

TSL project: TSL-or FAR doesn't exceed 3.5

Date submitted: 04/03/2020

Requirements

Affordable units: 44 *On-site aff. Units: 11

How do you intend to meet your required obligation

On-Site: 11 Off-Site: 0

On-Site to CHA or Authorized agency: 0 Off-Site to CHA or Authorized agency: 0

Total Units: 11 In-Lieu Fee Owed: 6,117,408

UNIT MIX/LAYOUT/DETAILS TBD - At the time of the execution of this Affordable Housing Profile, the developer had not finalized floor plans for the new rental tower.

Unit mix will need to be approved by ARO staff prior to the release of foundation/construction permit hold(s) for the new tower. ***This is a preliminary AHP.***



AFFORDABLE REQUIREMENTS ORDINANCE

ARO Web Form

Applicant Contact Information

Name: Lee Golub

Email: lgolub@goco.com

Development Information

Address

Printed Date: 04/03/2020

Number From: 421 Number To: 451 Direction: N

Street Name: Michigan Ave

Postal Code: 60611

Development Name

Are you rezoning to downtown?: Yes

Is your project subject to the ARO Pilots?: 2015 ARO REQUIREMENTS APPLY

Information

Ward: 42

ARO Zone: Downtown

Details

ARO trigger: ZP

Total units 287

Development type: Sale

TSL project: TSL-or FAR doesn't exceed 3.5

Date submitted: 04/03/2020

Requirements

Affordable units: 29 *On-site aff. Units: 0

How do you intend to meet your required obligation

On-Site: 0 Off-Site: 0

On-Site to CHA or Authorized agency: 0 Off-Site to CHA or Authorized agency: 0

Total Units: 0 In-Lieu Fee Owed: 6,911,860

BULK REGULATIONS & DATA TABLE

Site and Sub-Area Data

Gross Site Area:	204,440 square feet (4.693 acres)
Area in Adjoining Right-of-Way:	72,199 square feet (1.657 acres)
Net Site Area:	132,241 feet square feet (3.036 acres)
Sub-Area A:	74,395 square feet (1.708 acres)
Sub-Area B:	44,197 square feet (1.015 acres)
Sub-Area C:	13,649 square feet (0.313 acres)

Floor Area Ratio and Buildable Area

Base FAR Building Square Footage:	FAR 12;	1,586,892 square feet
Bonus FAR Building Square Footage:	FAR 3.31;	437,608 square feet
Total FAR Building Square Footage:	FAR 15.31;	2,024,500 square feet
Overall Site FAR:	15.31	

Sub-Area A:

Maximum FAR Buildable Square Footage Assigned to Sub-Area A:	630,000 square feet
FAR:	8.47

Sub-Area B:

Maximum FAR Buildable Square Footage Assigned to Subarea B:	1,369,500 square feet
FAR:	30.99

Sub-Area C:

Maximum FAR Buildable Square Footage Assigned to Subarea C:	25,000 square feet
FAR:	1.83

Maximum Height by Sub Area:

Sub-Area A:	456' Existing Building
Sub-Area B:	1,442'
Sub-Area C:	30'

BULK REGULATIONS & DATA TABLE

Number of Residential Units:

Sub-Area A:	162 Units
Sub-Area B:	564 Units (125 condo/439 rental)
Sub-Area C:	0 Units

Number of Hotel Keys:

Sub-Area A:	0 Keys
Sub-Area B:	200 Keys
Sub-Area C:	0 Keys

Setbacks:

Sub-Area A:	In substantial compliance with site plan.
Sub-Area B:	In substantial compliance with site plan.
Sub-Area C:	In substantial compliance with site plan.

Parking Spaces:

Sub-Area A:	261 Parking Spaces
Sub-Area B:	426 Parking Spaces
Sub-Area C:	None

Loading Berths:

Sub-Area A:	3 (10 feet by 25 feet) berths
Sub-Area B:	5 (10 feet by 25 feet) berth and 2 (10 feet by 50 feet) loading berths
Sub-Area C:	1 (10 feet by 25 feet) berth and 3 (10 feet by 50 feet) loading berths

EXISTING ZONING MAP

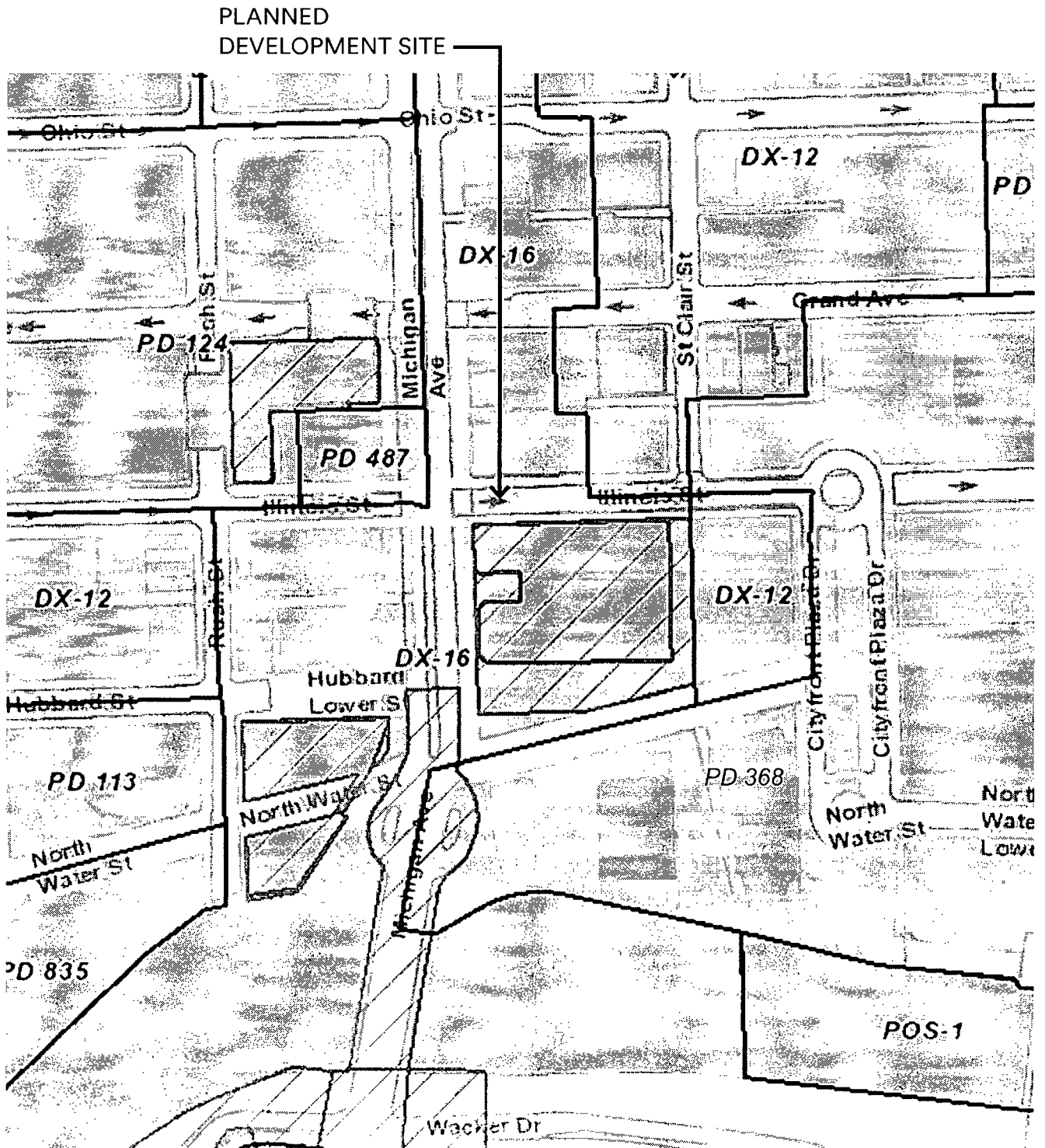

Applicant: Tribune Tower East (Chicago) Owner, LLC
Address: 421-51 N. Michigan Ave., 137-209 E. Illinois & 458-78 N Cityfront Plaza Dr.
Introduced: January 15, 2020
CPC: May 08, 2020

NTS

EXISTING LAND USE MAP

PLANNED
DEVELOPMENT SITE

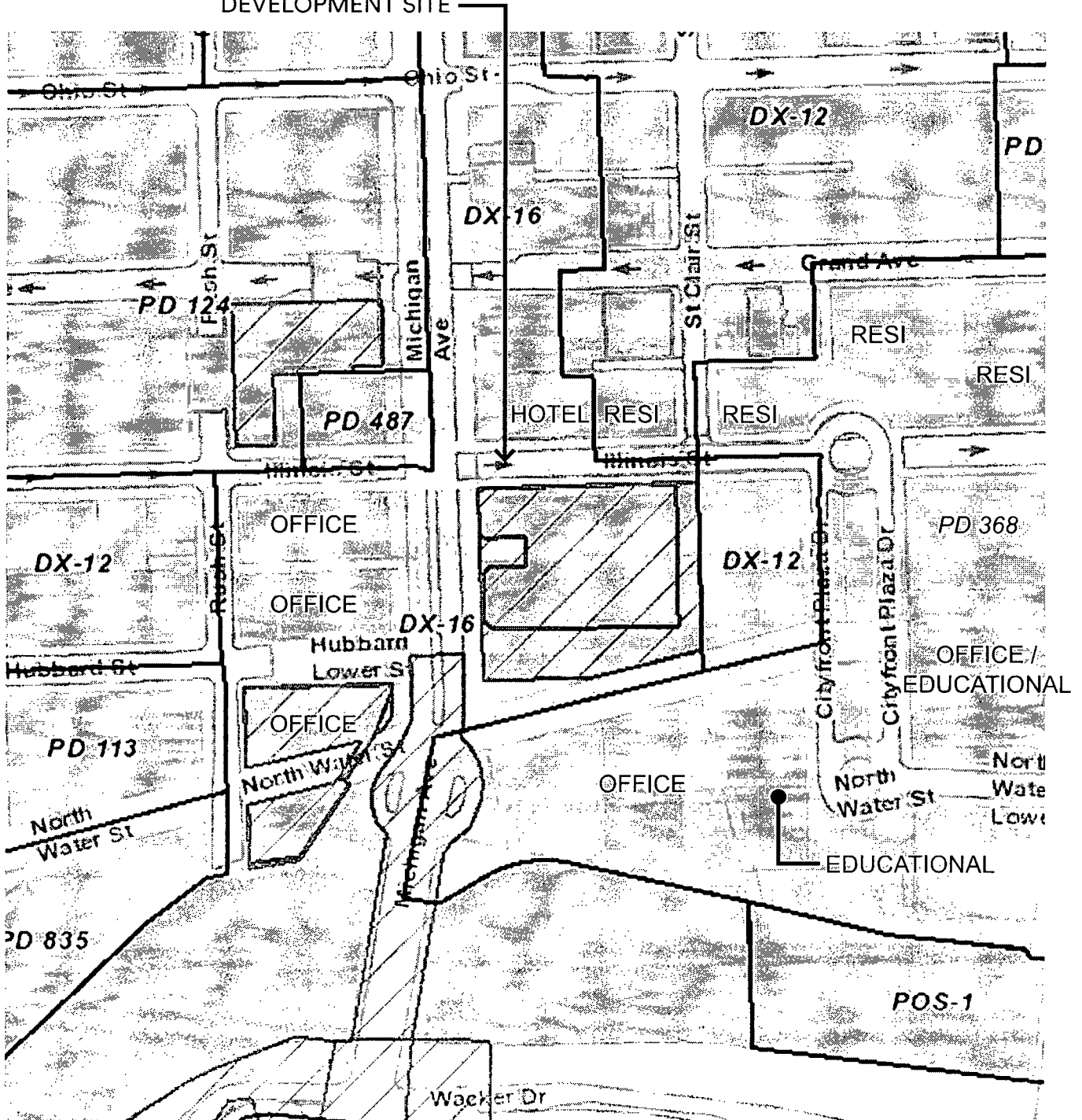

Applicant: Tribune Tower East (Chicago) Owner, LLC
Address: 421-51 N. Michigan Ave., 137-209 E. Illinois & 458-78 N. Cityfront Plaza Dr.
Introduced: January 15, 2020
CPC: May 08, 2020

NTS

PLAN DEVELOPMENT BOUNDARY AND PROPERTY LINE MAP

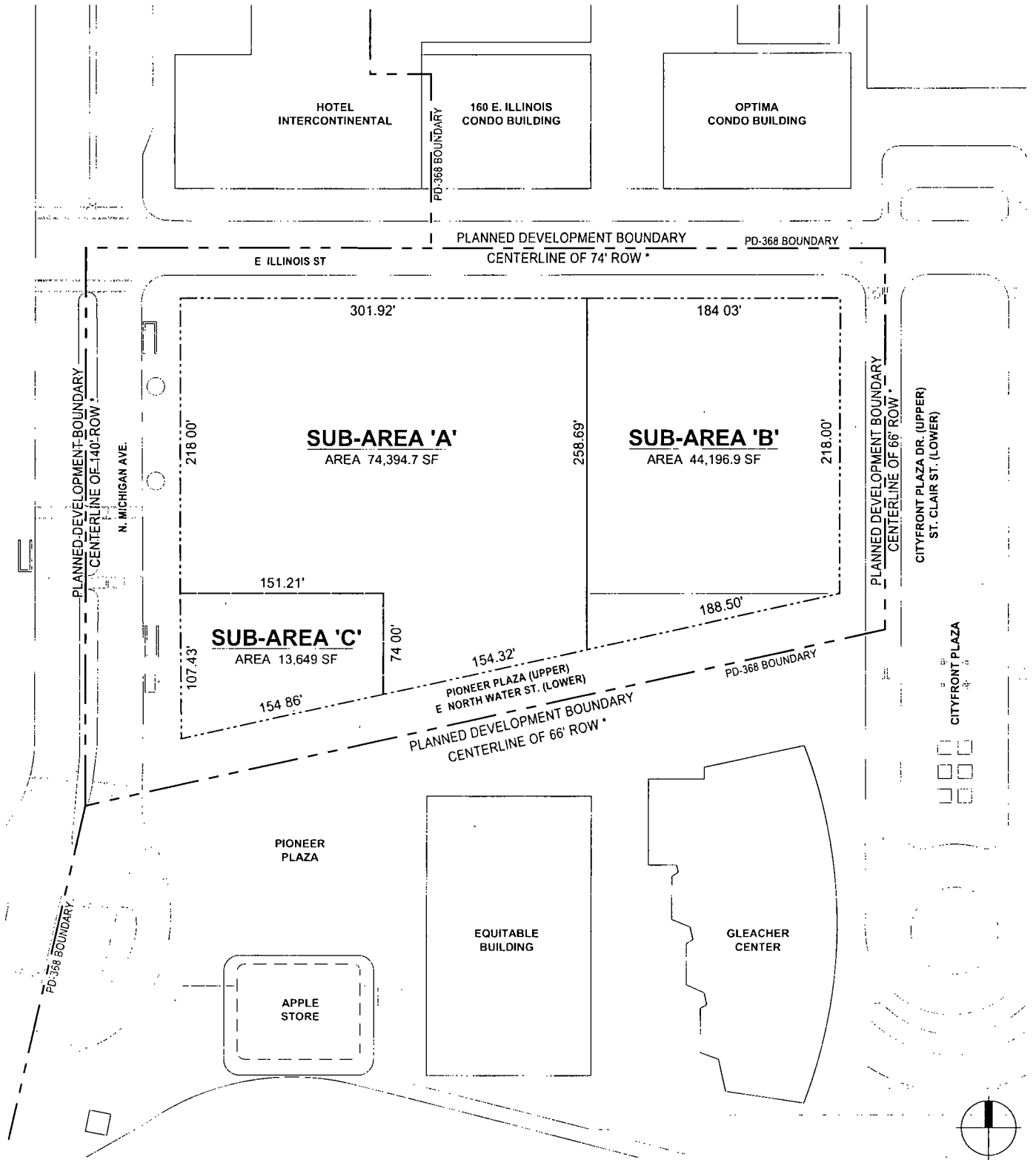

Applicant: Tribune Tower East (Chicago) Owner, LLC
Address: 421-51 N. Michigan Ave., 137-209 E. Illinois & 458-78 N. Cityfront Plaza Dr.
Introduced: January 15, 2020
CPC. May 08, 2020



SUB-AREA MAP

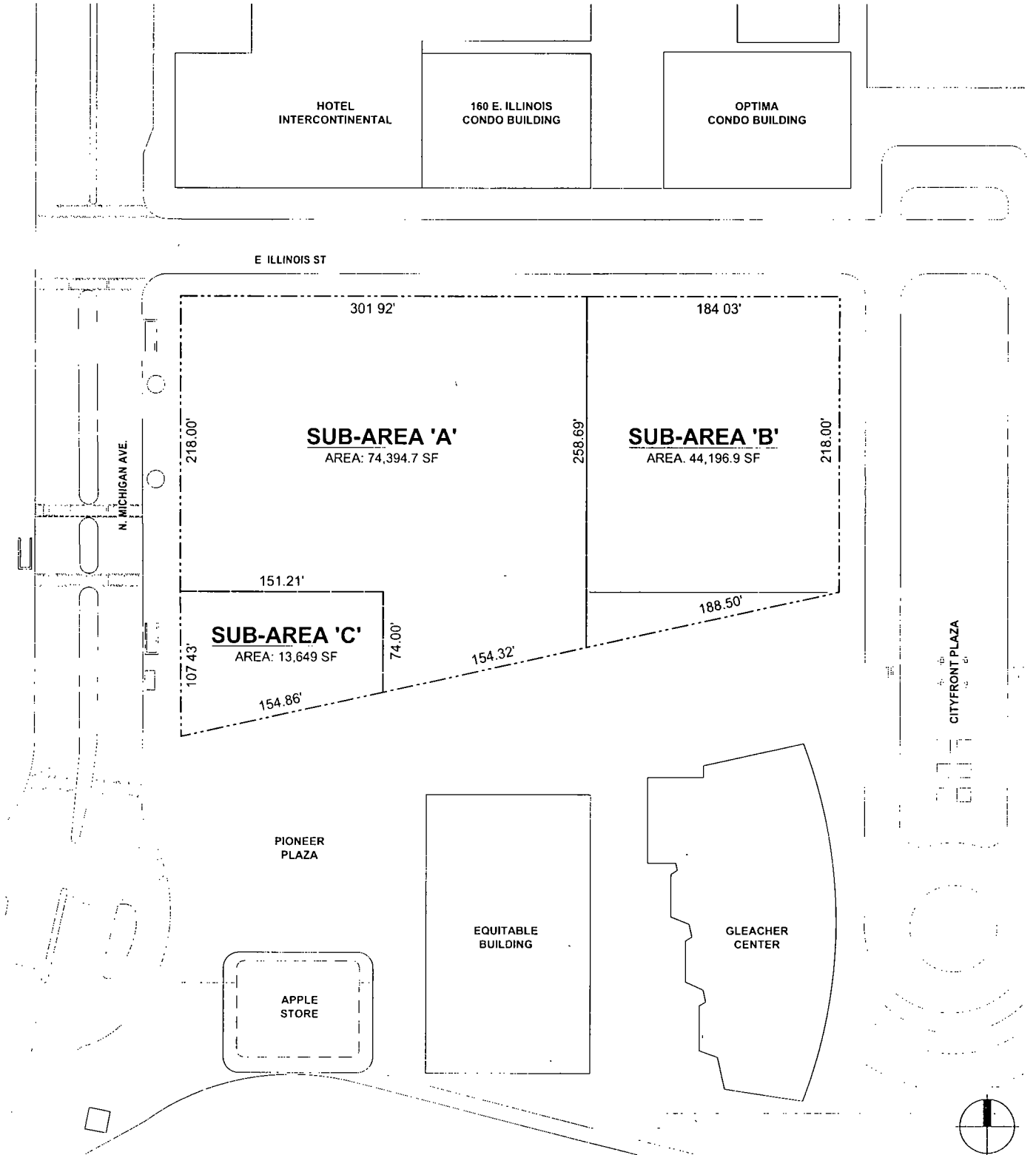

Applicant: Tribune Tower East (Chicago) Owner, LLC
Address: 421-51 N. Michigan Ave , 137-209 E. Illinois & 458-78 N. Cityfront Plaza Dr.
Introduced: January 15, 2020
CPC: May 08, 2020

0' 50' 100'

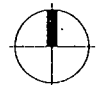

OVERALL ROOF PLAN

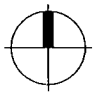
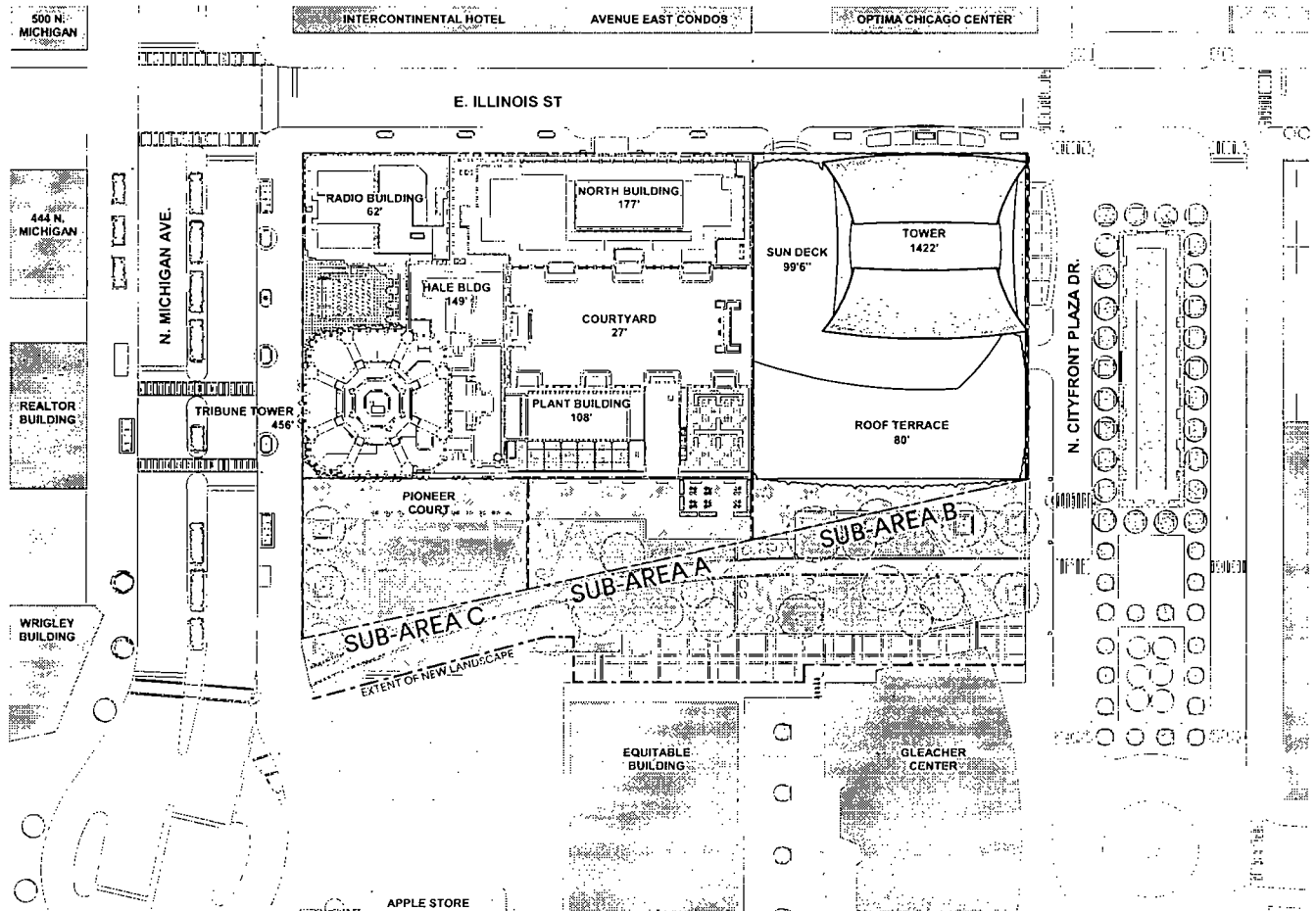

Applicant: Tribune Tower East (Chicago) Owner, LLC
Address: 421-51 N. Michigan Ave., 137-209 E. Illinois & 458-78 N. Cityfront Plaza Dr.
Introduced: January 15, 2020
CPC: May 08, 2020

0' 60' 120'

OVERALL UPPER STREET LEVEL SITE PLAN

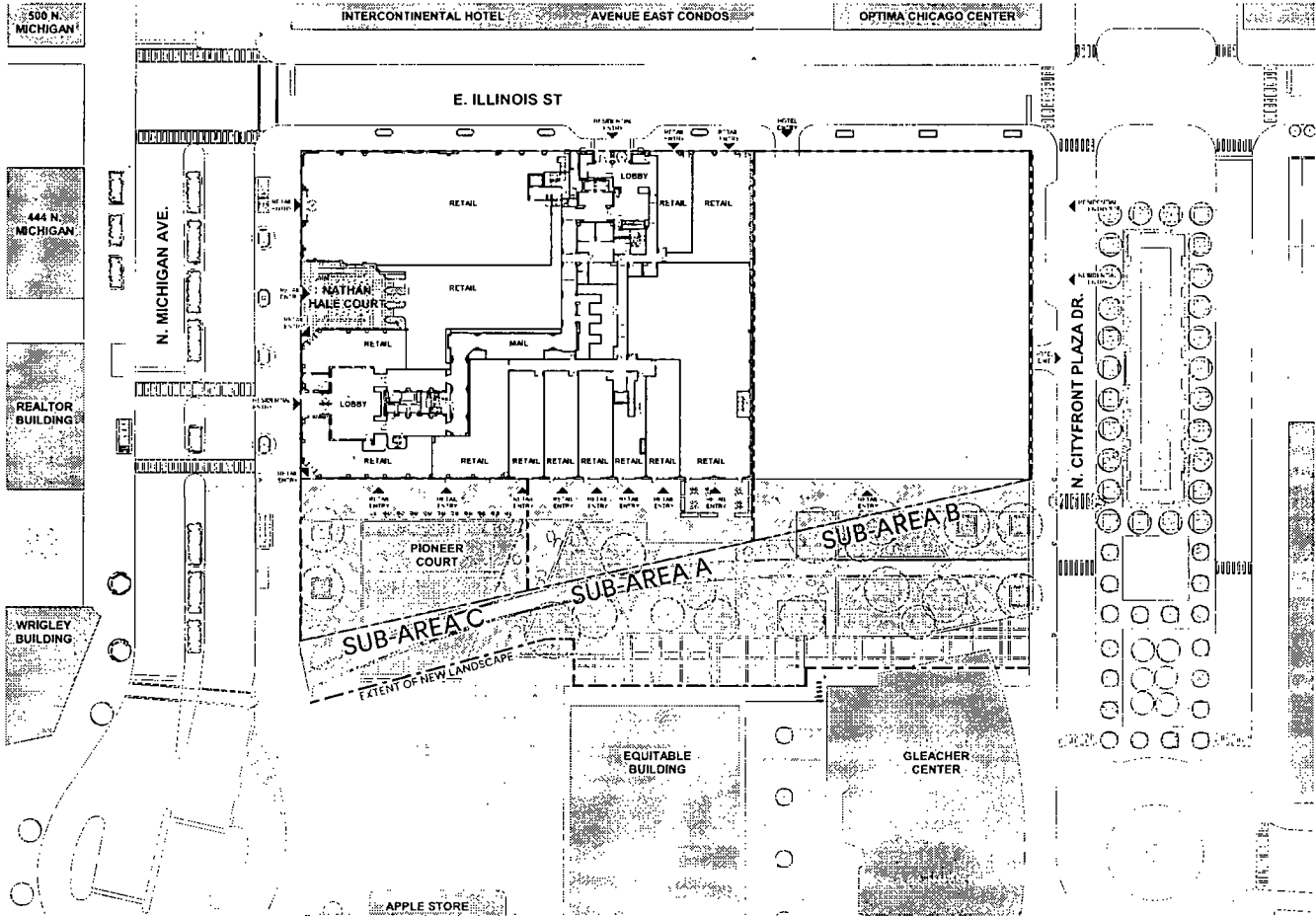

Applicant: Tribune Tower East (Chicago) Owner, LLC
Address: 421-51 N. Michigan Ave., 137-209 E. Illinois & 458-78 N Cityfront Plaza Dr.
Introduced: January 15, 2020
CPC: May 08, 2020

0' 60' 120'

OVERALL SOUTH ELEVATION

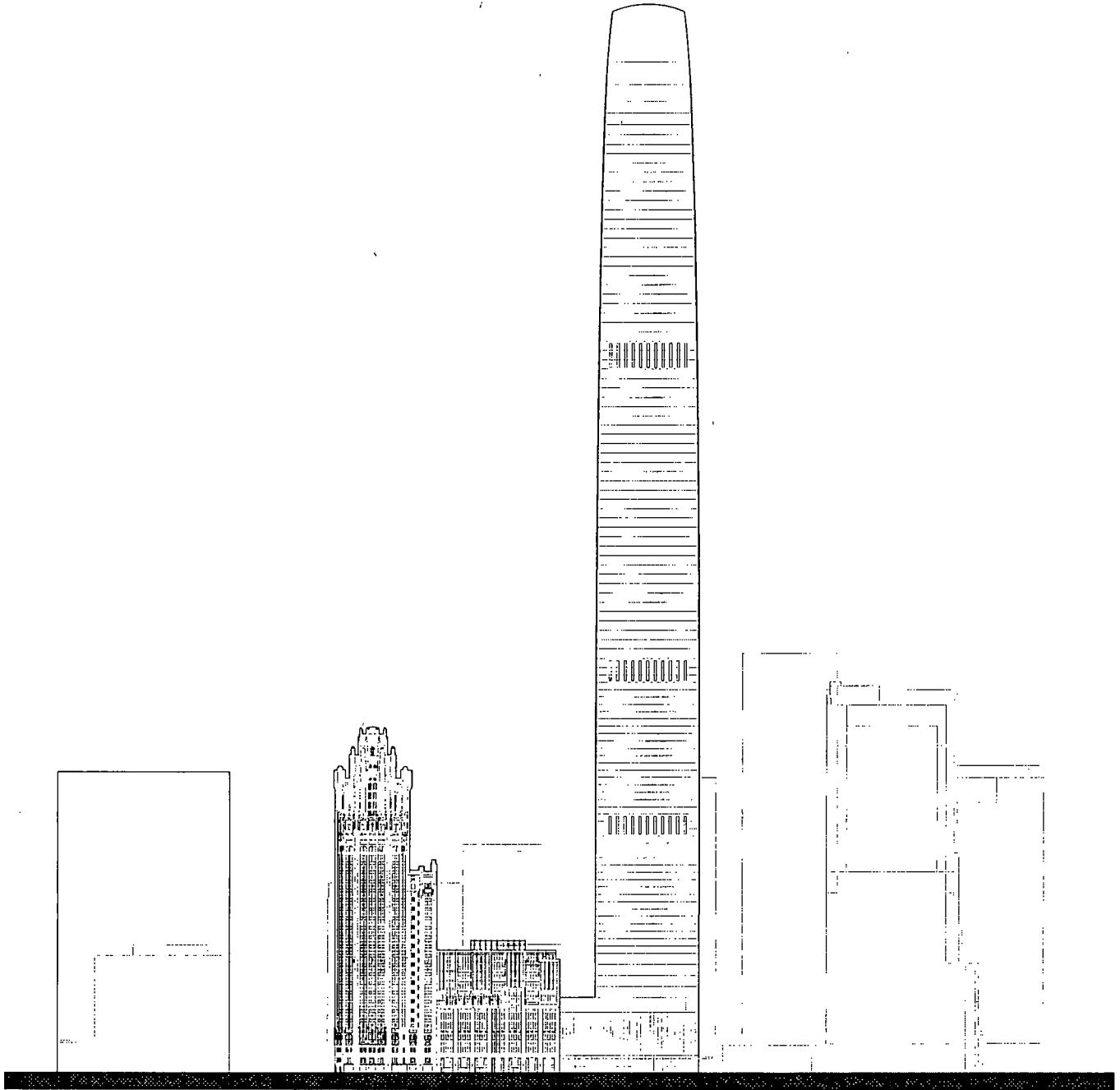

Applicant: Tribune Tower East (Chicago) Owner, LLC
Address: 421-51 N. Michigan Ave., 137-209 E. Illinois & 458-78 N. Cityfront Plaza Dr.
Introduced: January 15, 2020
CPC: May 08, 2020

0' 100' 200'

OVERALL EAST ELEVATION

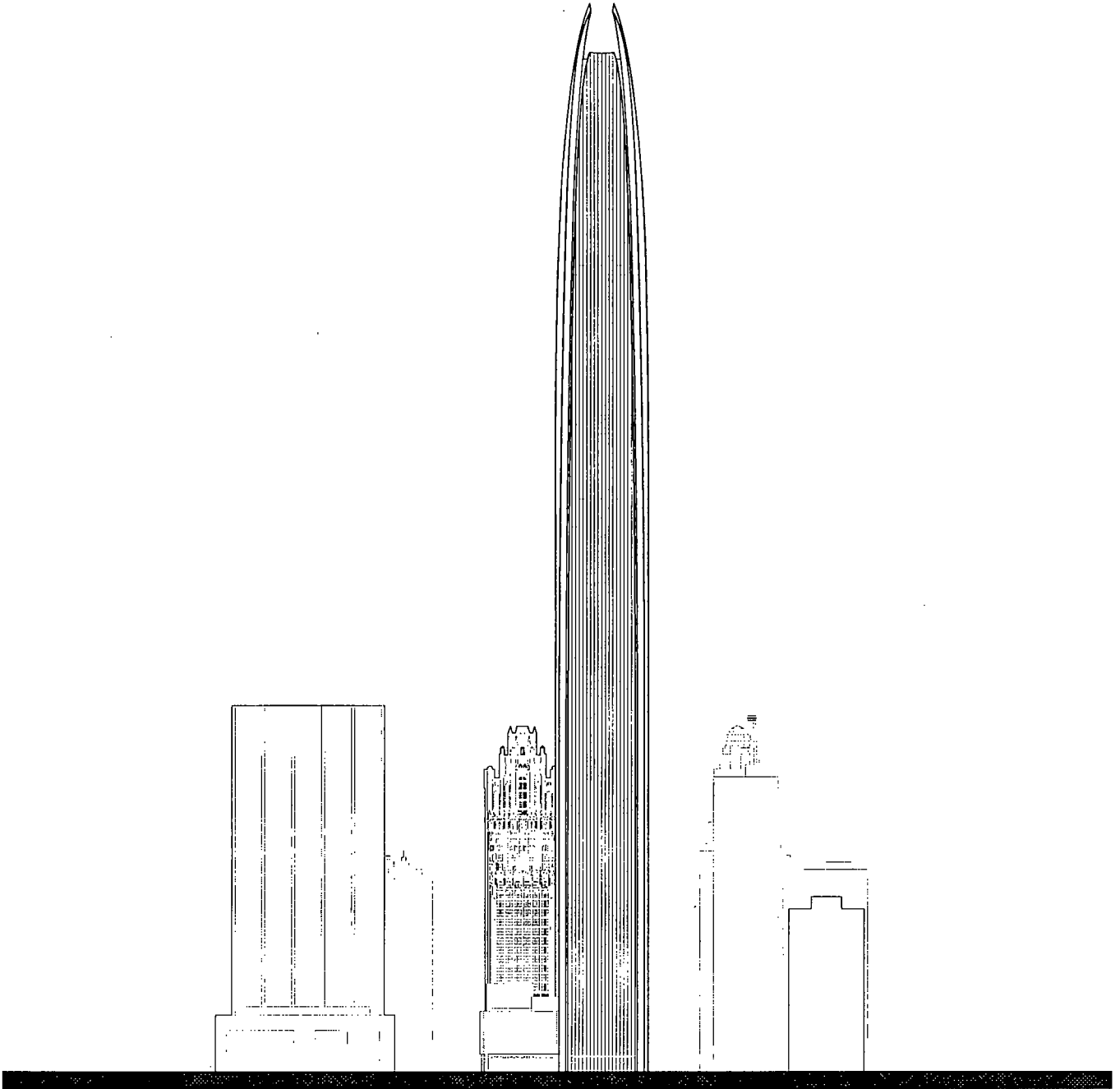

Applicant: Tribune Tower East (Chicago) Owner, LLC
Address: 421-51 N Michigan Ave., 137-209 E. Illinois & 458-78 N. Cityfront Plaza Dr
Introduced: January 15, 2020
CPC: May 08, 2020

0' 100' 200'

OVERALL NORTH ELEVATION

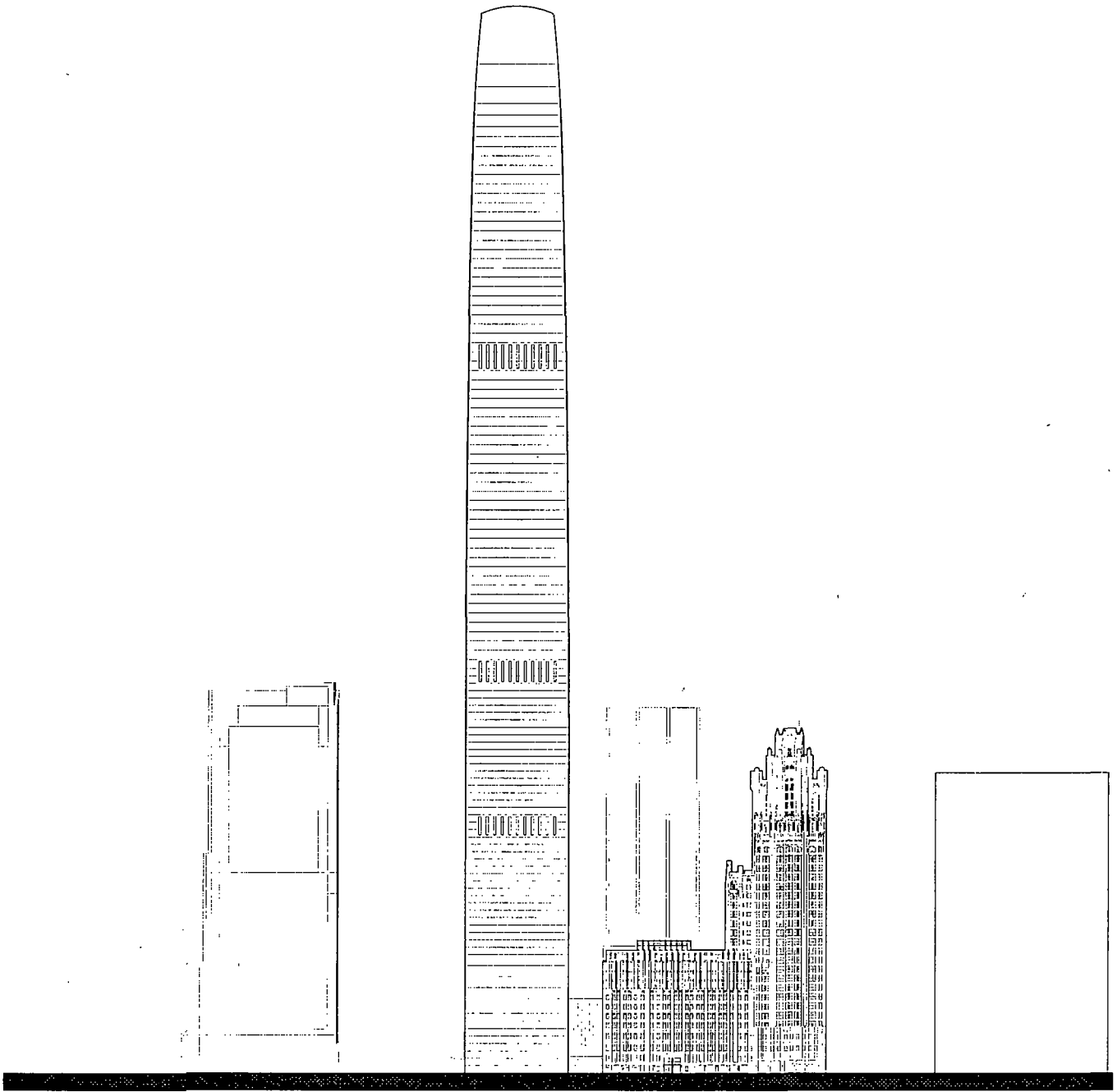

Applicant: Tribune Tower East (Chicago) Owner, LLC
Address: 421-51 N. Michigan Ave., 137-209 E. Illinois & 458-78 N. Cityfront Plaza Dr.
Introduced: January 15, 2020
CPC: May 08, 2020

0' 100' 200'

OVERALL WEST ELEVATION

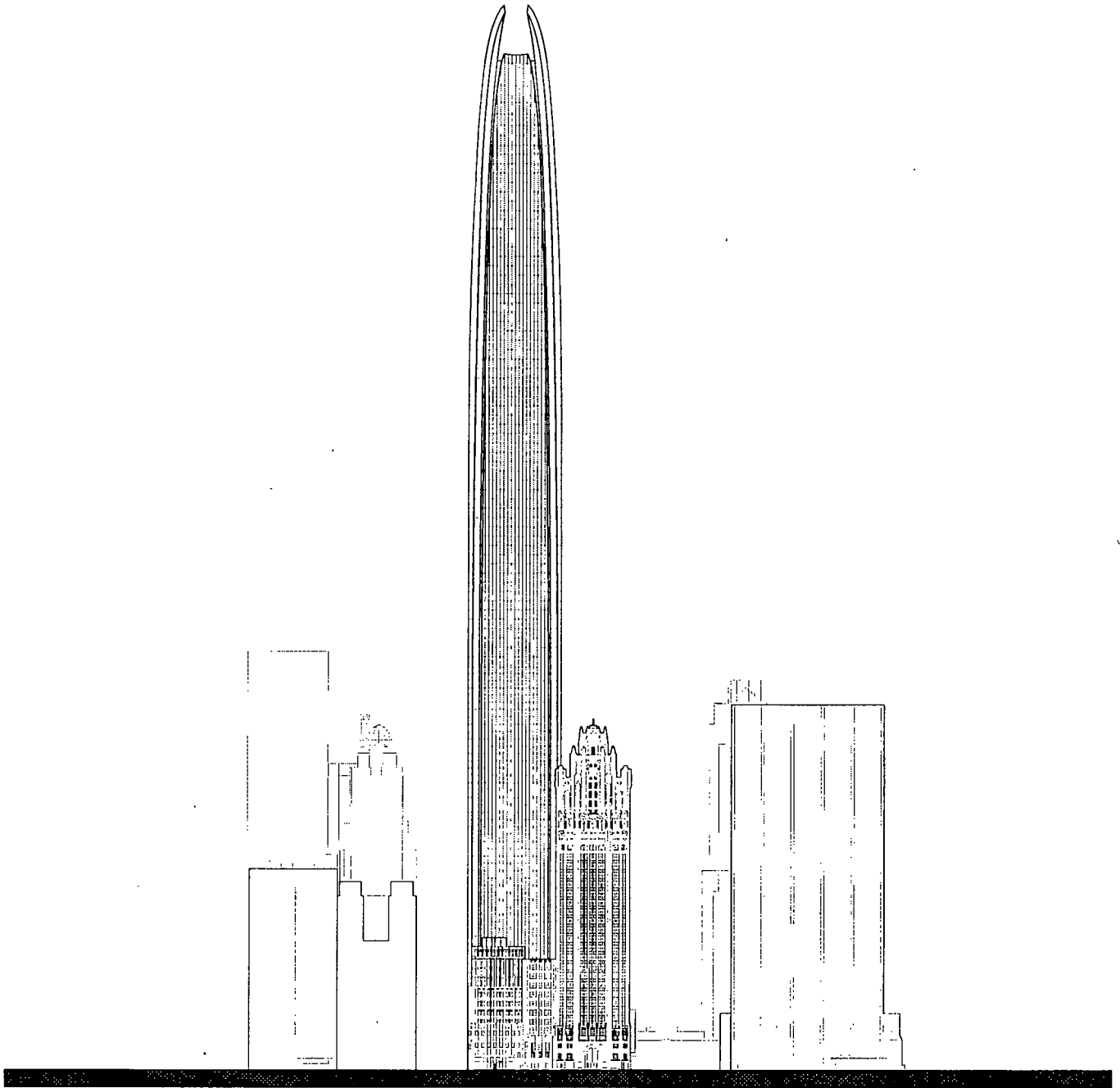

Applicant: Tribune Tower East (Chicago) Owner, LLC
Address: 421-51 N. Michigan Ave., 137-209 E. Illinois & 458-78 N. Cityfront Plaza Dr.
Introduced: January 15, 2020
CPC: May 08, 2020

0' 100' 200'

SUB-AREA A - LOWER LEVEL L2 PLAN

PARKING LEVELS SECTION DIAGRAM

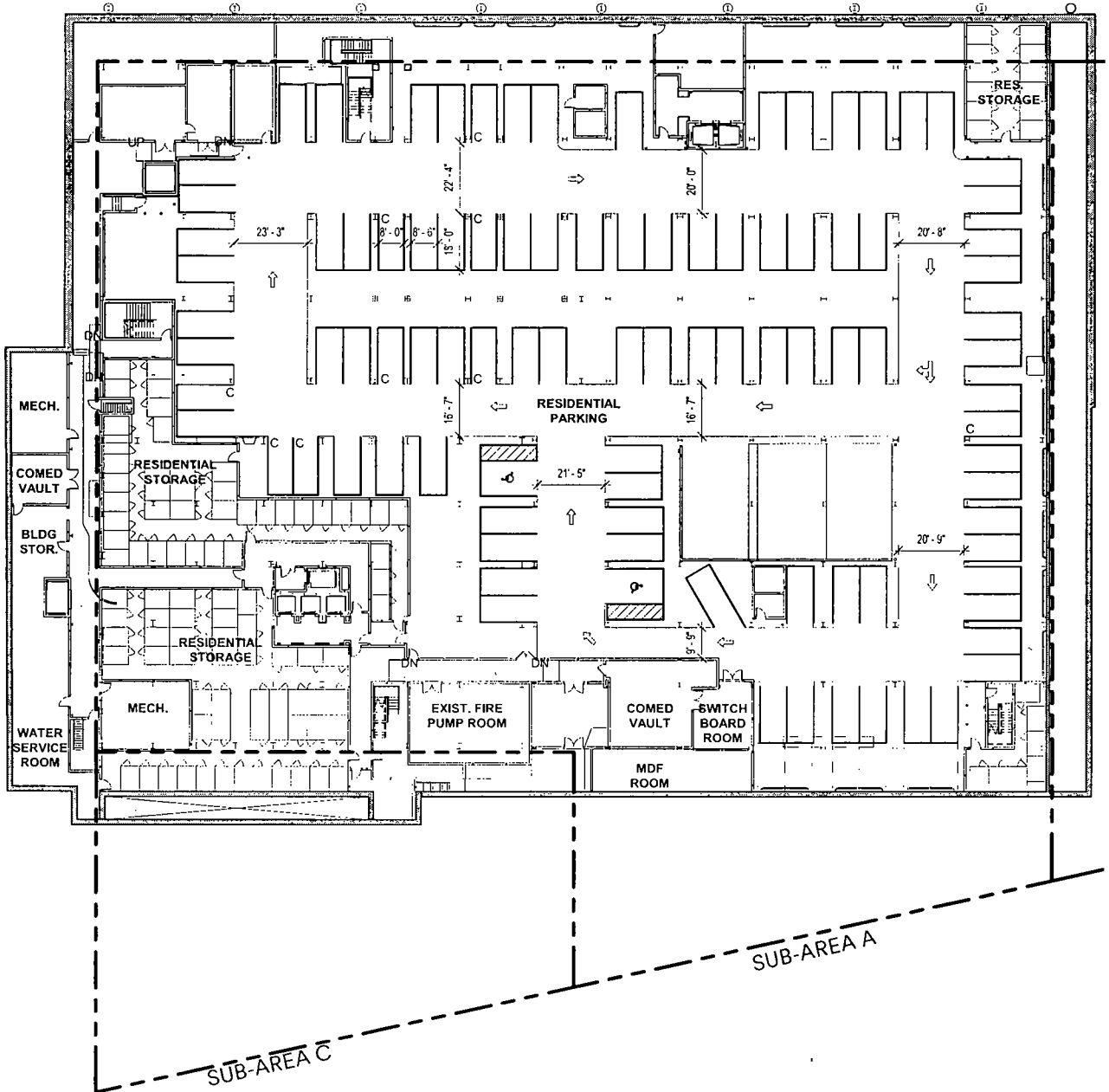
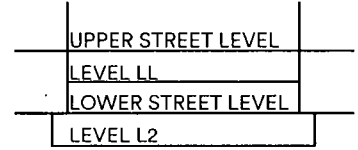

Applicant: Tribune Tower East (Chicago) Owner, LLC
Address: 421-51 N. Michigan Ave., 137-209 E. Illinois & 458-78 N. Cityfront Plaza Dr.
Introduced: January 15, 2020
CPC: May 08, 2020

0' 25' 50'

SUB-AREA A - LOWER STREET LEVEL PLAN

PARKING LEVELS SECTION DIAGRAM

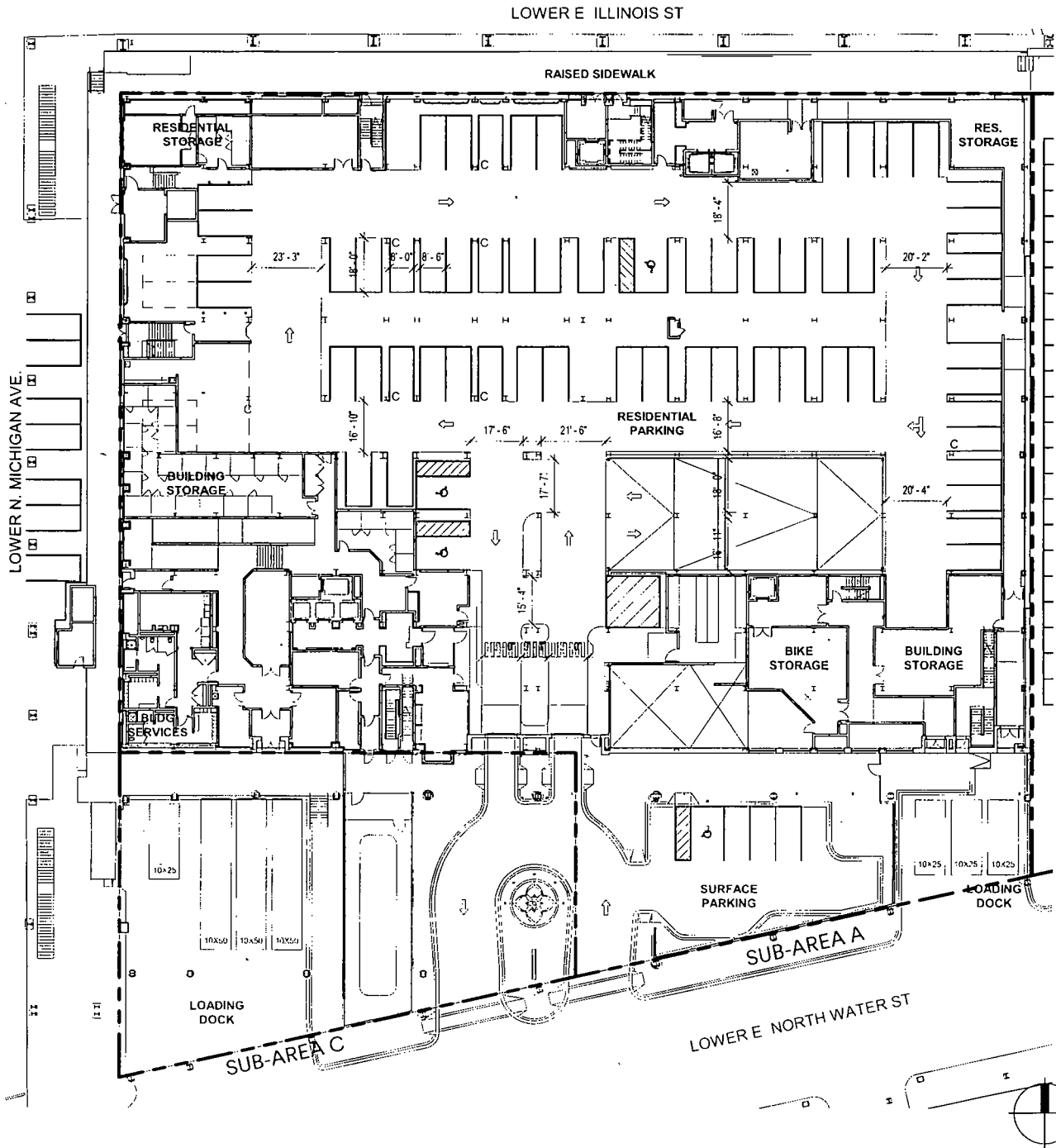
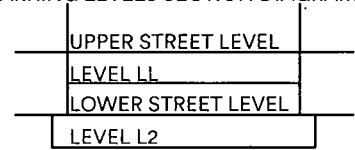

Applicant: Tribune Tower East (Chicago) Owner, LLC
Address: 421-51 N. Michigan Ave., 137-209 E. Illinois & 458-78 N. Cityfront Plaza Dr.
Introduced: January 15, 2020
CPC: May 08, 2020

0' 25' 50'
15

SUB-AREA A - LOWER LEVEL LL PLAN

PARKING LEVELS SECTION DIAGRAM

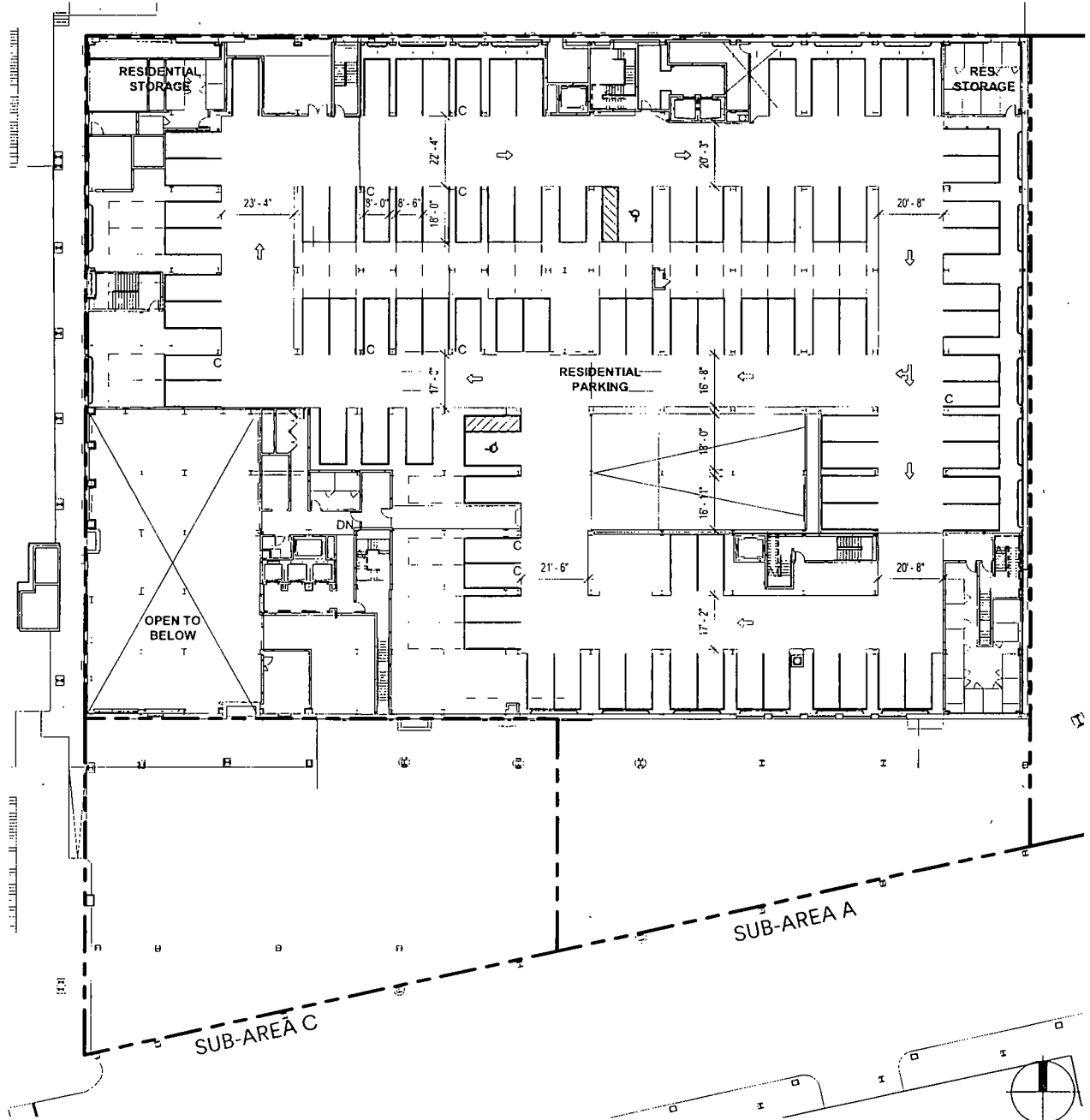
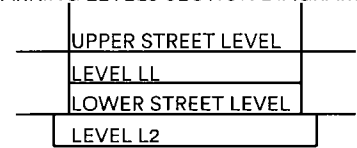

Applicant: Tribune Tower East (Chicago) Owner, LLC
Address: 421-51 N. Michigan Ave , 137-209 E. Illinois & 458-78 N. Cityfront Plaza Dr.
Introduced: January 15, 2020
CPC: May 08, 2020

0' 25' 50'

SUB-AREA A - UPPER STREET LEVEL PLAN

PARKING LEVELS SECTION DIAGRAM

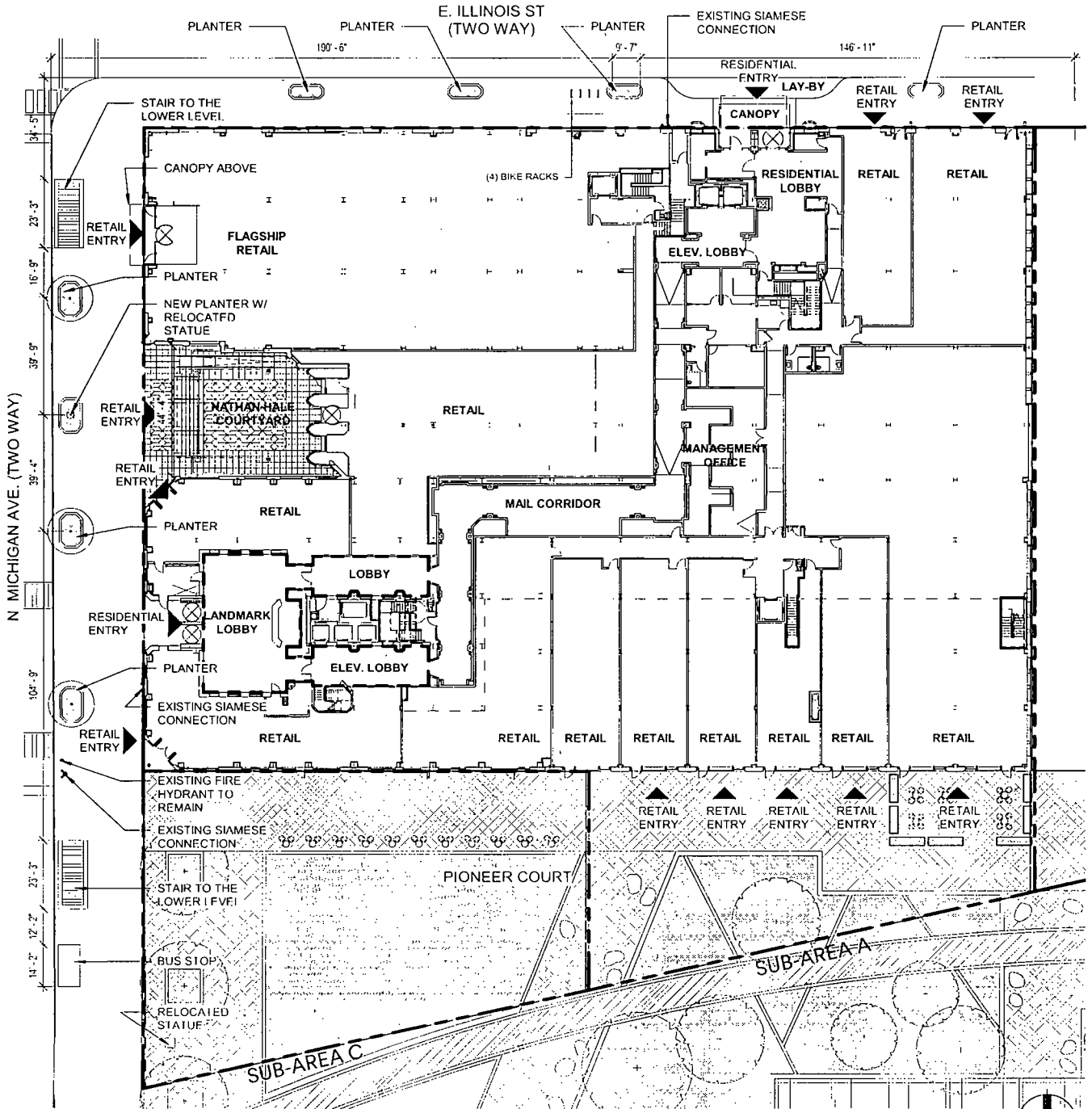
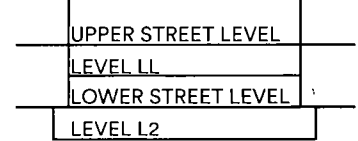

Applicant: Tribune Tower East (Chicago) Owner, LLC
 Address: 421-51 N. Michigan Ave., 137-209 E. Illinois & 458-78 N. Cityfront Plaza Dr.
 Introduced: January 15, 2020
 CPC: May 08, 2020

0' 25' 50'

SUB-AREA A - LANDSCAPE PLAN

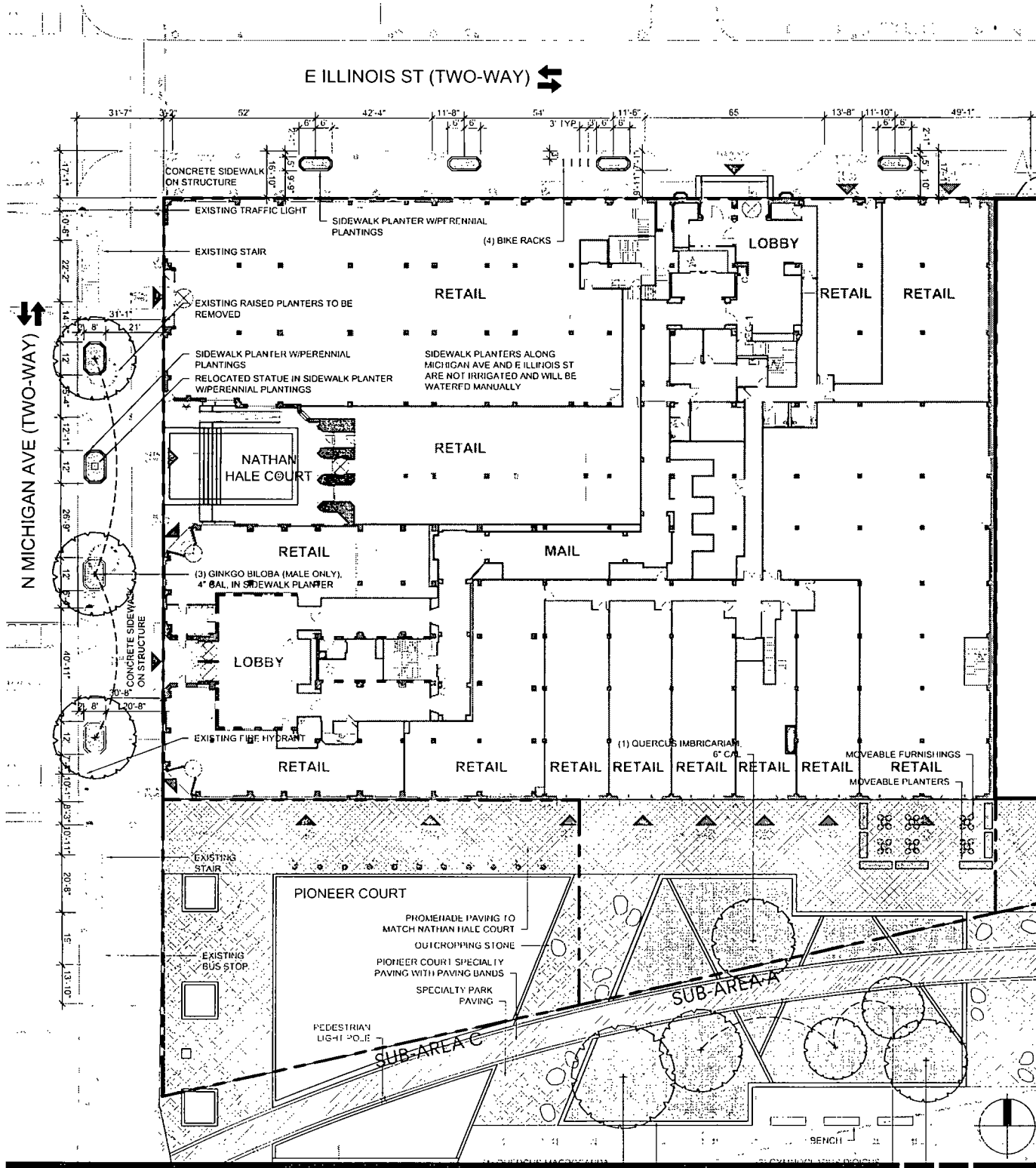

Applicant: Tribune Tower East (Chicago) Owner, LLC
Address: 421-51 N. Michigan Ave , 137-209 E. Illinois & 458-78 N. Cityfront Plaza Dr.
Introduced: January 15, 2020
CPC: May 08, 2020

SUB-AREA A - PLANTER DETAILS

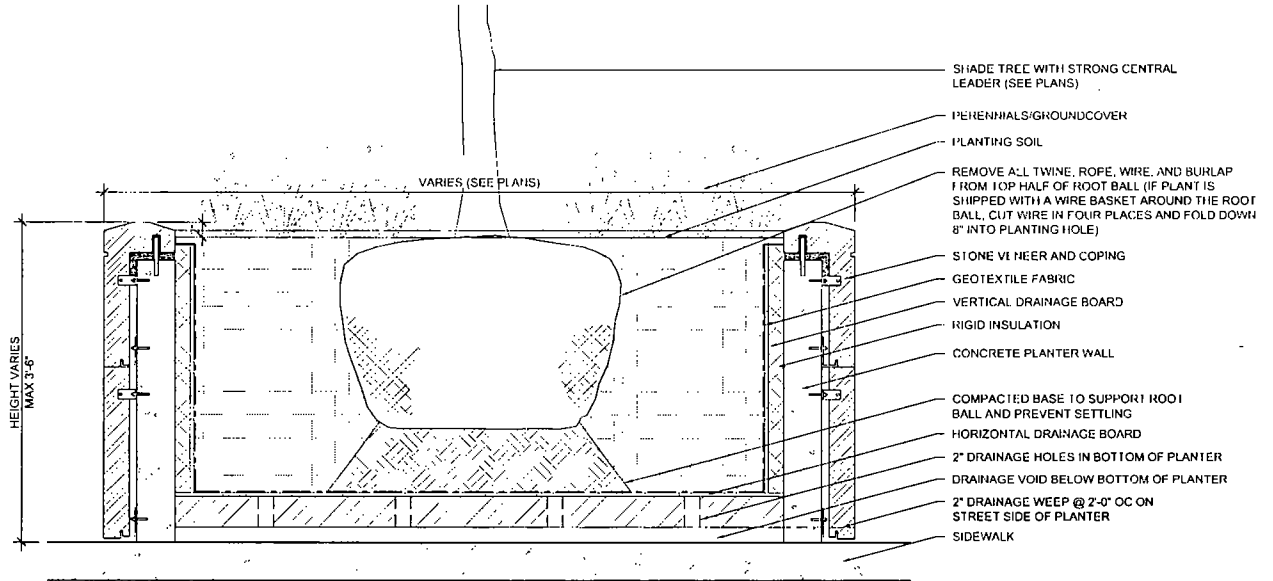

1 **SIDEWALK PLANTER W/TREE SECTION**
1/2" = 1'-0"

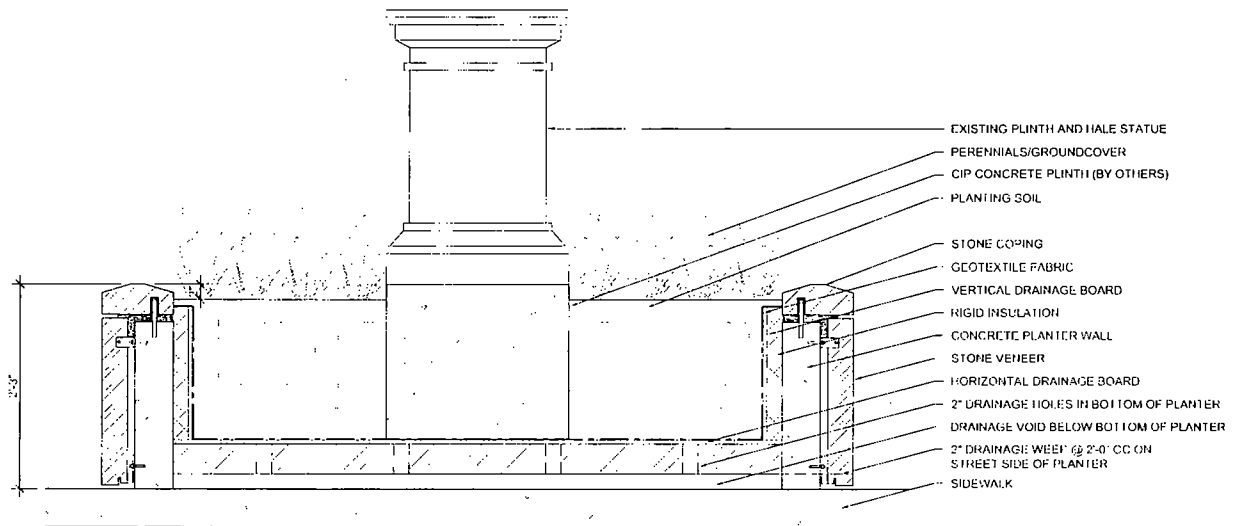

2 **SIDEWALK PLANTER W/STATUE SECTION**
1/2" = 1'-0"



Applicant: Tribune Tower East (Chicago) Owner, LLC
 Address: 421-51 N. Michigan Ave., 137-209 E. Illinois & 458-78 N. Cityfront Plaza Dr.
 Introduced: January 15, 2020
 CPC: May 08, 2020

SUB-AREA A - DETAILS & PLANT LIST

PLANT SCHEDULE - SUB-AREA A					
QTY	BOTANICAL NAME	COMMON NAME	ROOT	SIZE	REMARKS
6	<i>Gymnocladus dioicus</i> 'Espresso'	Espresso Kentucky Coffee Tree	B&B	4" cal	matching heads
1	<i>Quercus bicolor</i>	Swamp White Oak	B&B	6" cal	matching heads
1	<i>Quercus imbricaria</i>	Shingle Oak	B&B	6" cal	matching heads
1	<i>Quercus macrocarpa</i>	Bur Oak	B&B	6" cal	matching heads

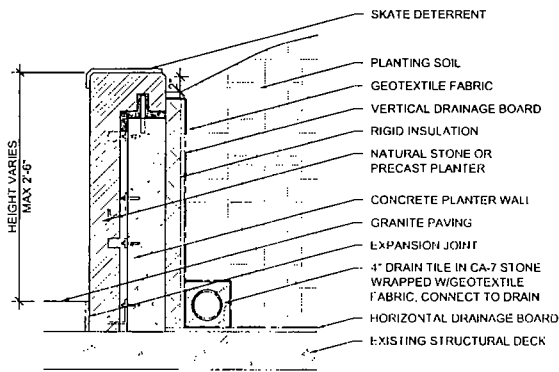

1 RAISED PLANTER SECTION
1/2" = 1'-0"

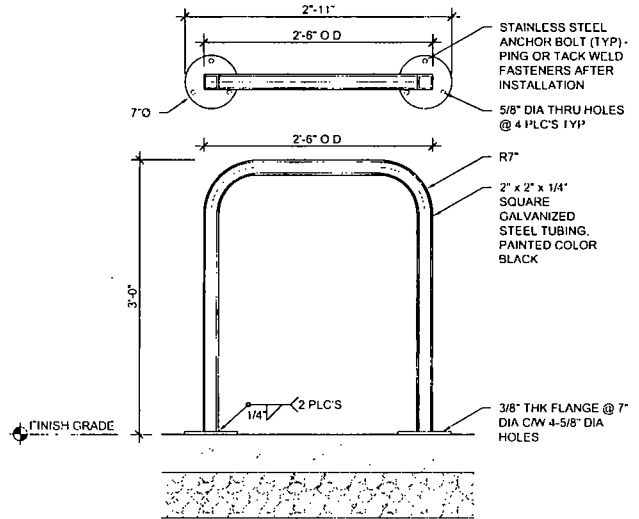

2 BIKE RACK DETAIL
1/2" = 1'-0"

Applicant: Tribune Tower East (Chicago) Owner, LLC
 Address: 421-51 N. Michigan Ave., 137-209 E. Illinois & 458-78 N. Cityfront Plaza Dr.
 Introduced: January 15, 2020
 CPC: May 08, 2020

SUB-AREA A - OPEN SPACE PLAN

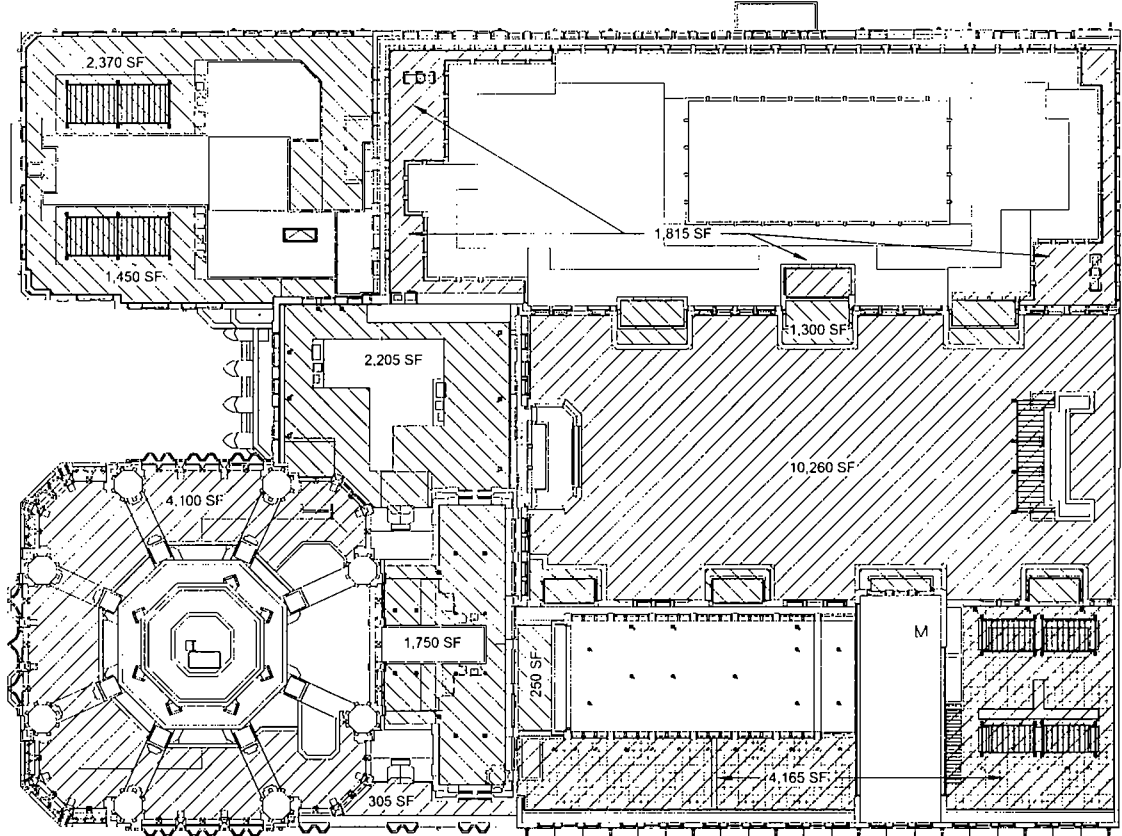

Open Spaces	SF
Total Number of Residential Units	162
Required Open Space Area (36 SF/Unit)	5,832
Provided Open Space Areas	
Level 03 Outdoor Terrace	10,260
Level 03 Private Terrace	1,300
Level 05 Private Terrace North	2,370
Level 05 Private Terrace South	1,450
Level 05 Outdoor Terrace	305
Level 07 Outdoor Terrace	4,165
Level 08 Private Terrace	250
Level 12 Private Terrace Tower	2,205
Level 12 Private Terrace North Wing	1,815
Level 22 Private Terraces	1,750
Level 25 Outdoor Terrace	4,100
Courtyard Balconies 4-11	5,097
Total	35,067
Resulting Open Space Area per Unit	216



Applicant: Tribune Tower East (Chicago) Owner, LLC
 Address: 421-51 N. Michigan Ave., 137-209 E. Illinois & 458-78 N. Cityfront Plaza Dr.
 Introduced: January 15, 2020
 CPC: May 08, 2020

0' 25' 50'

SUB-AREA A - WEST ELEVATION

T/ TRIBUNE TOWER
EL: 456' - 0"

LEVEL 25 AMENITY
EL: 317' - 10"

T/ NORTH ADDITION
EL: 176' - 7"

T/ NATHAN HALE BUILDING
EL: 149' - 5"

T/ NORTH BUILDING
EL: 113' - 0"

T/ RADIO BUILDING
EL: 62' - 4"

UPPER STREET LEVEL
EL: 0' - 0"

LOWER STREET LEVEL
EL: -21' - 11"

METAL

GLASS

METAL

GLASS

STONE

GLASS

METAL

STONE

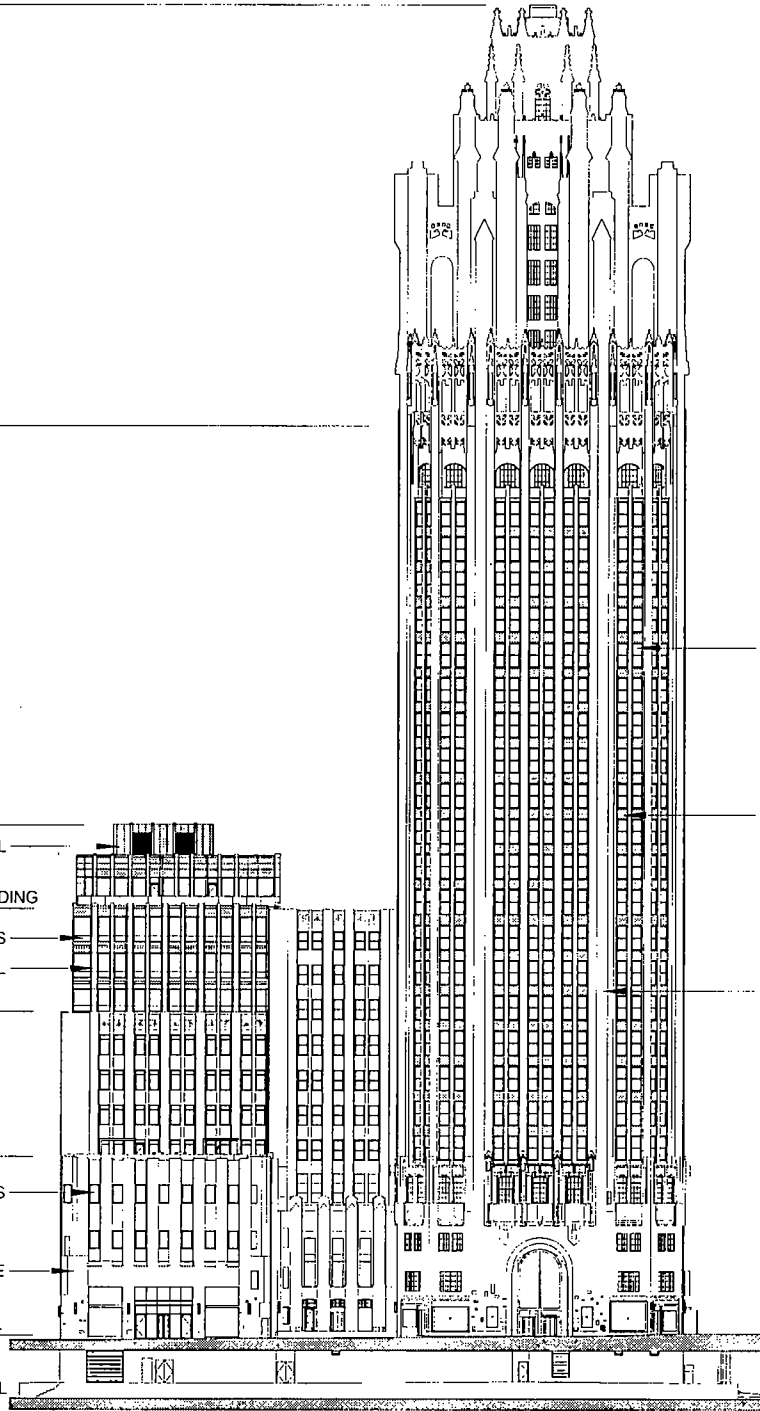

Applicant: Tribune Tower East (Chicago) Owner, LLC
Address: 421-51 N. Michigan Ave., 137-209 E. Illinois & 458-78 N. Cityfront Plaza Dr.
Introduced: January 15, 2020
CPC: May 08, 2020

0' 32' 64'
22

SUB-AREA A - SOUTH ELEVATION

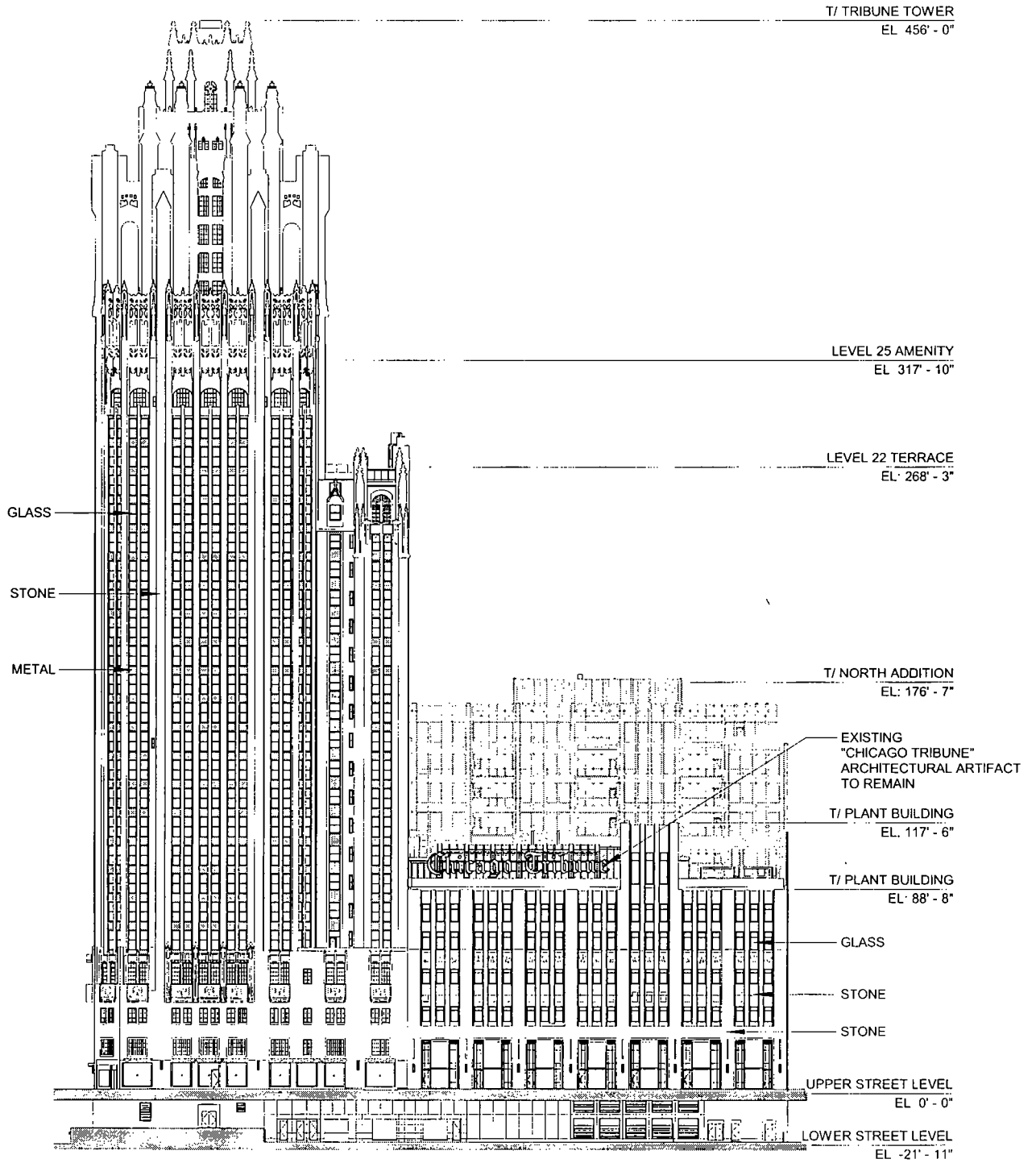

Applicant: Tribune Tower East (Chicago) Owner, LLC
Address: 421-51 N. Michigan Ave., 137-209 E. Illinois & 458-78 N. Cityfront Plaza Dr,
Introduced January 15, 2020
CPC: May 08, 2020

0' 32' 64'
23

SUB-AREA A - SOUTH ELEVATION "CHICAGO TRIBUNE" ARTIFACT

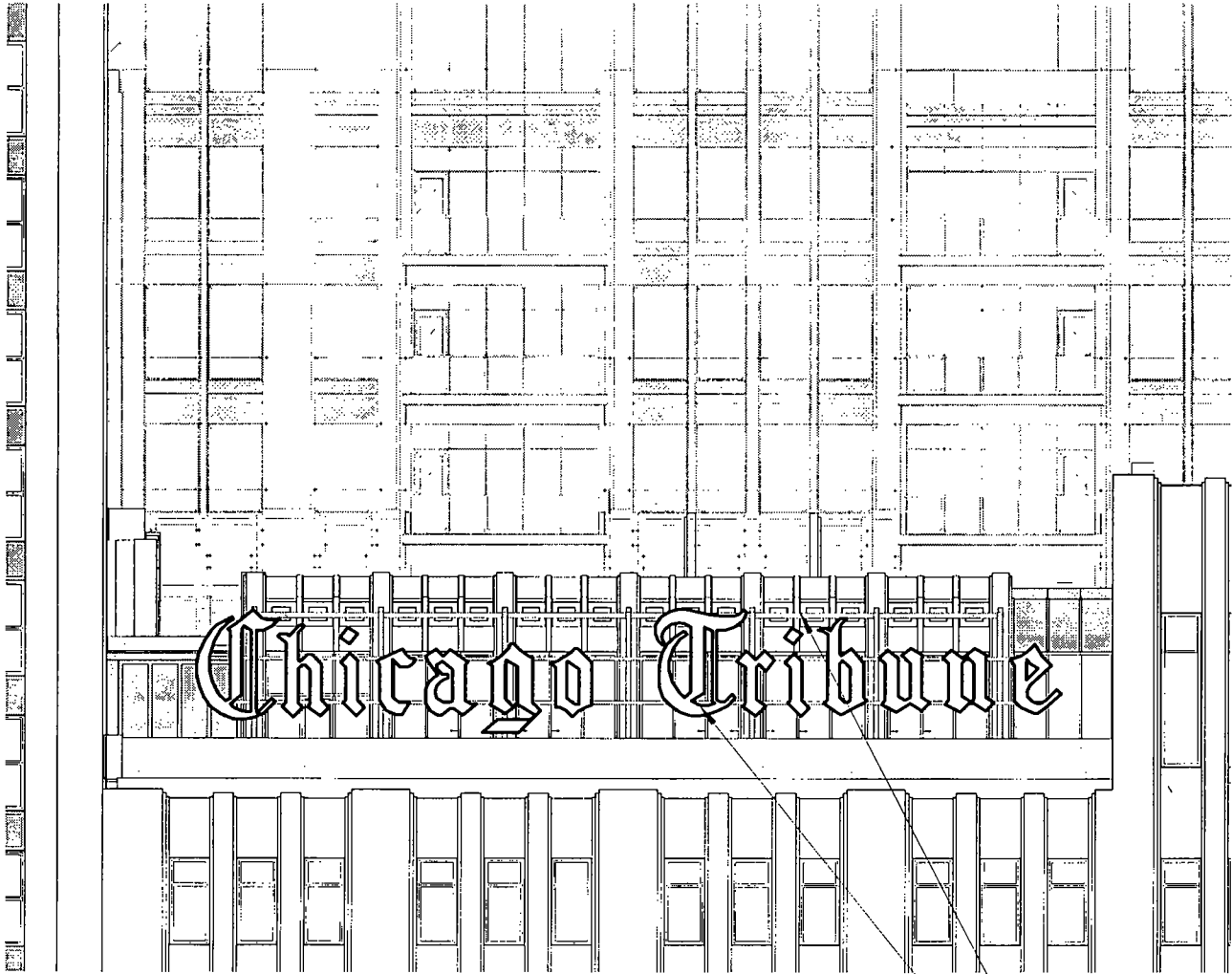

STRUCTURAL SUPPORT FOR
ARCHITECTURAL ARTIFACT

EXISTING "CHICAGO TRIBUNE"
ARCHITECTURAL ARTIFACT
TO REMAIN

Applicant: Tribune Tower East (Chicago) Owner, LLC
Address: 421-51 N. Michigan Ave., 137-209 E. Illinois & 458-78 N. Cityfront Plaza Dr.
Introduced: January 15, 2020
CPC: May 08, 2020

0' 8' 16'
24

SUB-AREA A - EAST ELEVATION

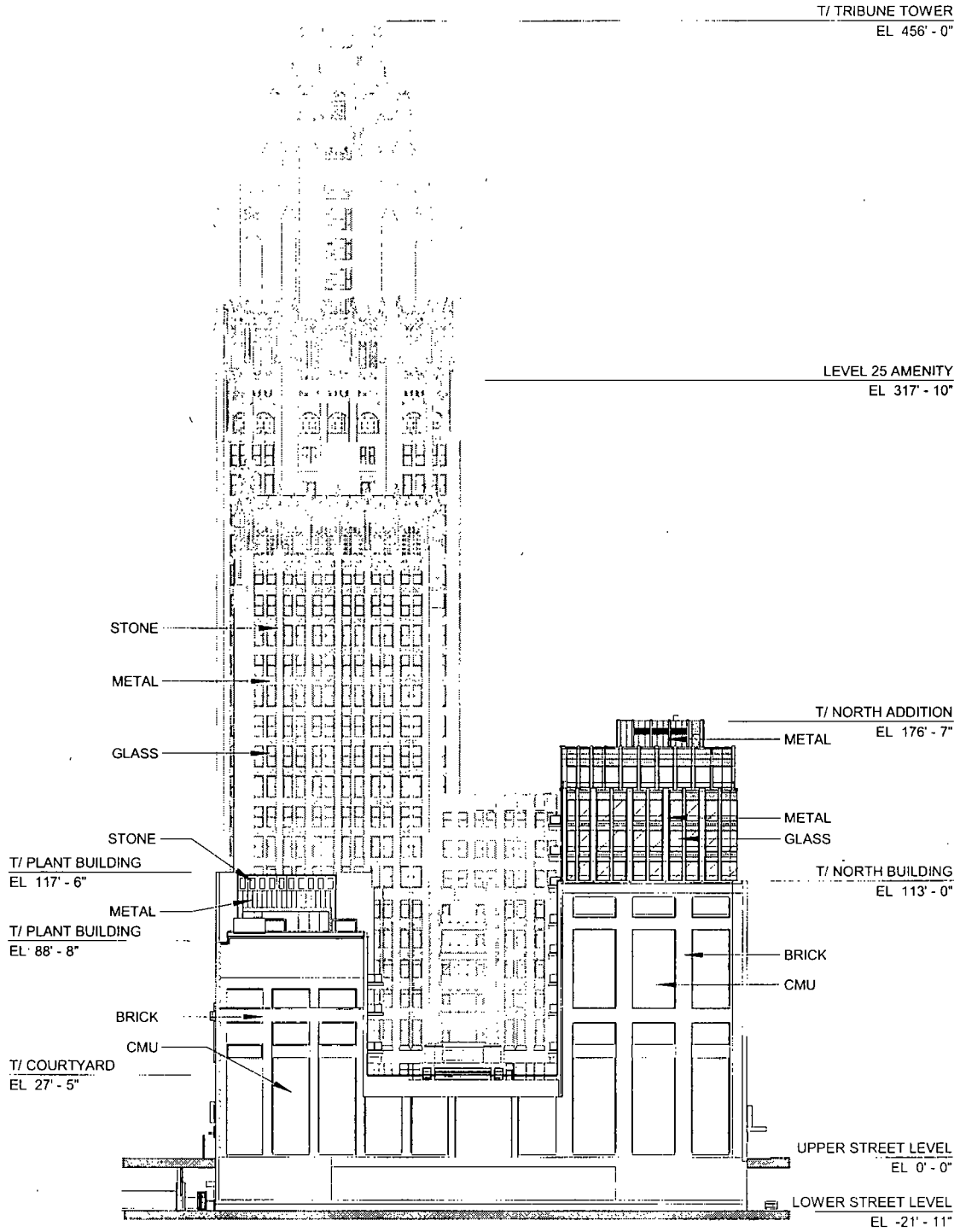

Applicant: Tribune Tower East (Chicago) Owner, LLC
Address: 421-51 N. Michigan Ave., 137-209 E. Illinois & 458-78 N. Cityfront Plaza Dr.
Introduced: January 15, 2020
CPC: May 08, 2020

0' 32' 64'
25

SUB-AREA A - NORTH ELEVATION

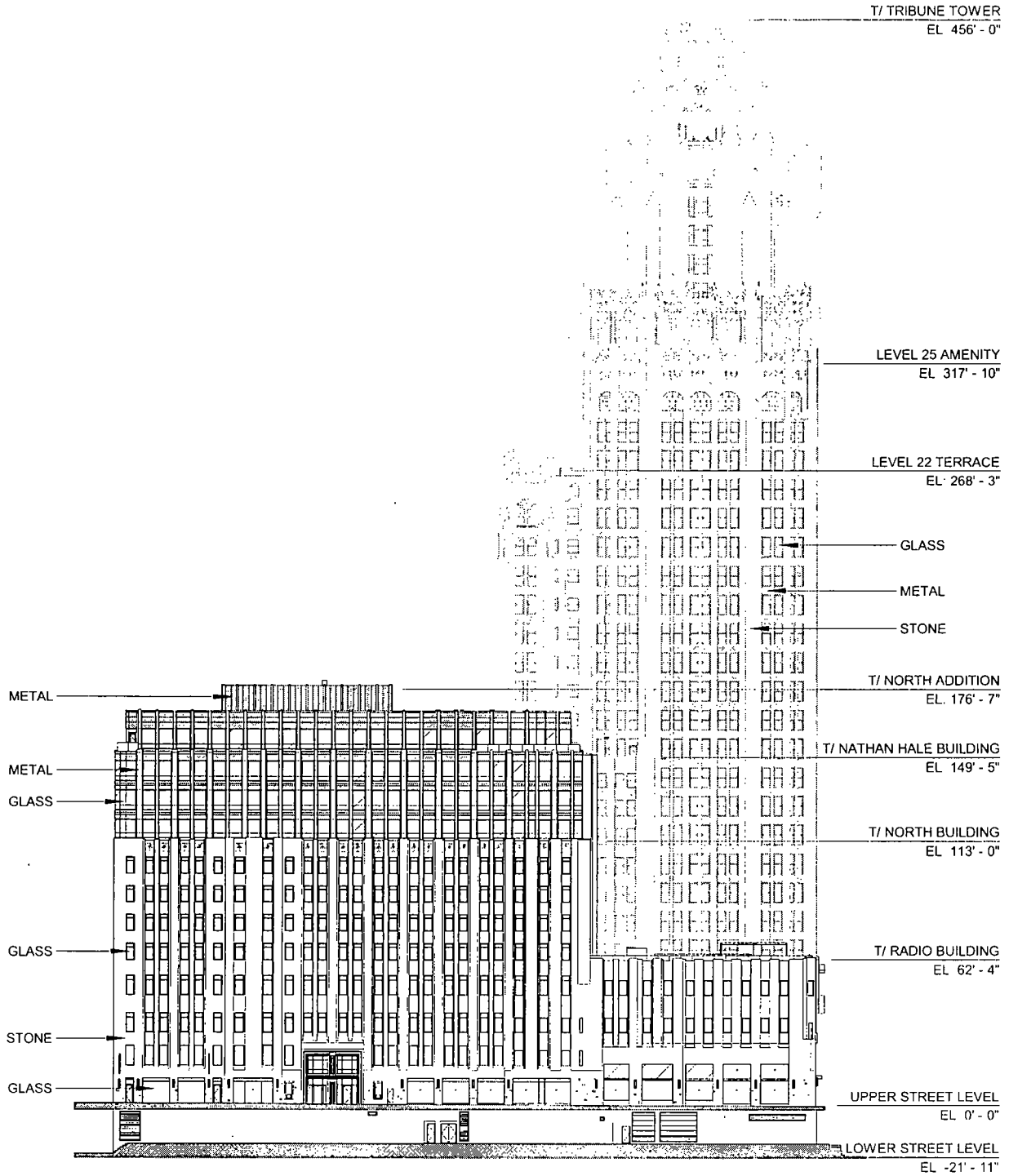

Applicant: Tribune Tower East (Chicago) Owner, LLC
Address: 421-51 N. Michigan Ave., 137-209 E. Illinois & 458-78 N. Cityfront Plaza Dr.
Introduced: January 15, 2020
CPC: May 08, 2020

0' 32' 64'
26

SUB-AREA A - EAST/WEST BUILDING SECTION

T/ TRIBUNE TOWER
EL 456' - 0"

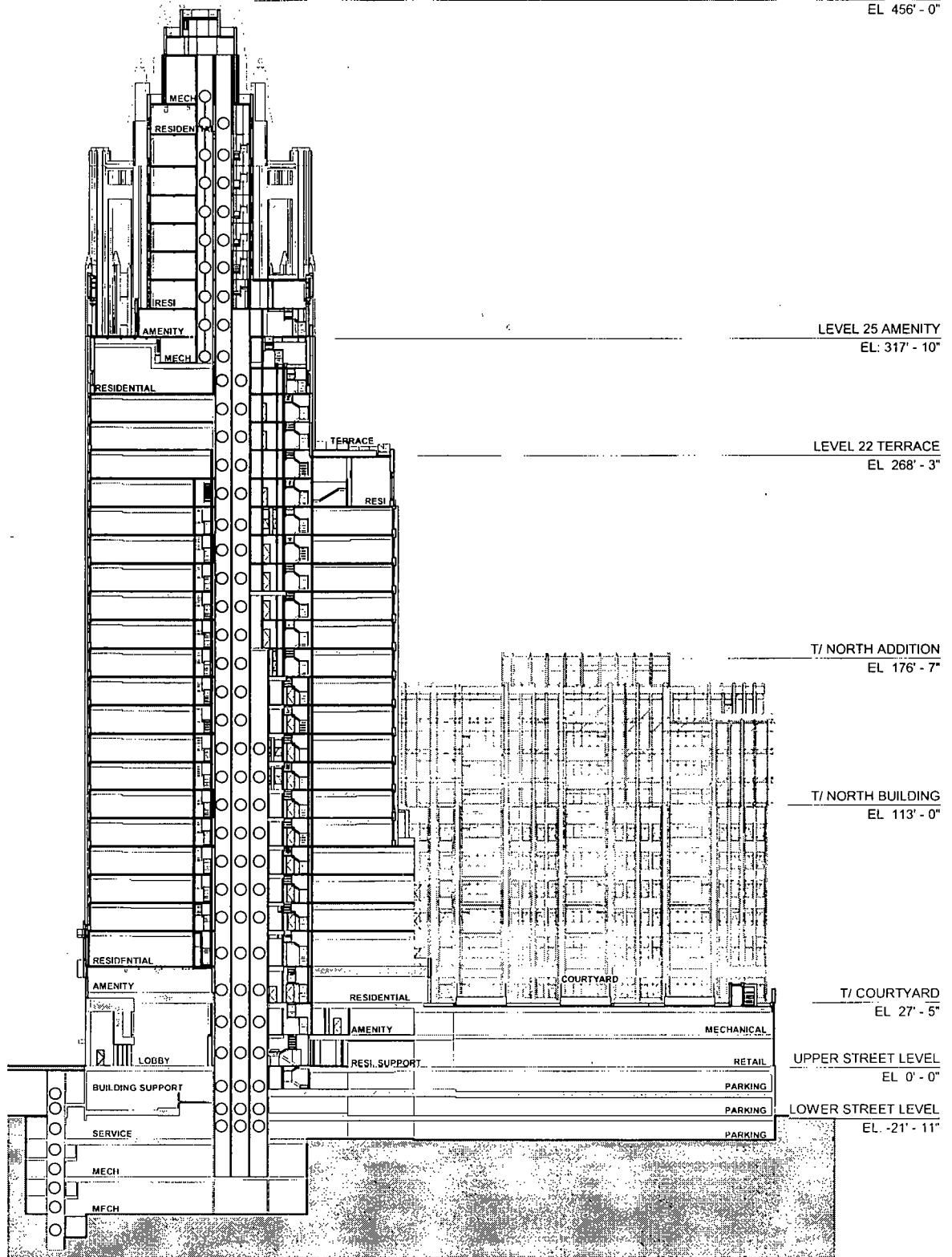

Applicant: Tribune Tower East (Chicago) Owner, LLC
 Address: 421-51 N. Michigan Ave., 137-209 E. Illinois & 458-78 N. Cityfront Plaza Dr.
 Introduced: January 15, 2020
 CPC: May 08, 2020

0' 32' 64'
27

SUB-AREA A - NORTH/SOUTH BUILDING SECTION

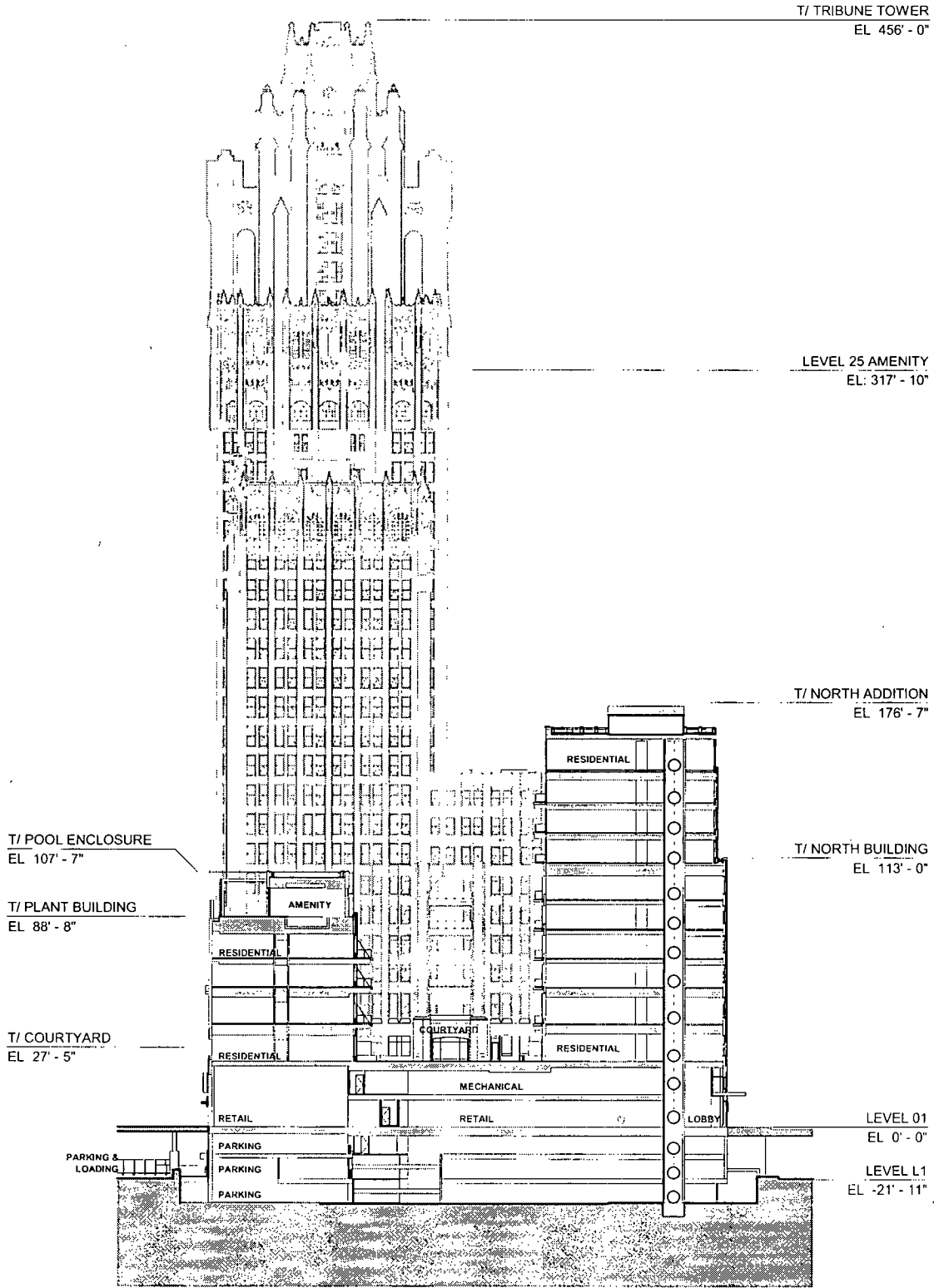

Applicant: Tribune Tower East (Chicago) Owner, LLC
Address: 421-51 N. Michigan Ave., 137-209 E. Illinois & 458-78 N. Cityfront Plaza Dr.
Introduced: January 15, 2020
CPC: May 08, 2020

0' 32' 64'
28

SUB-AREA B - LOWER STREET LEVEL PLAN

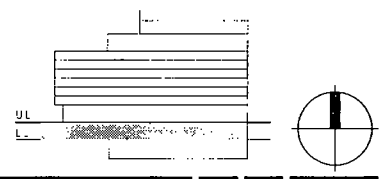
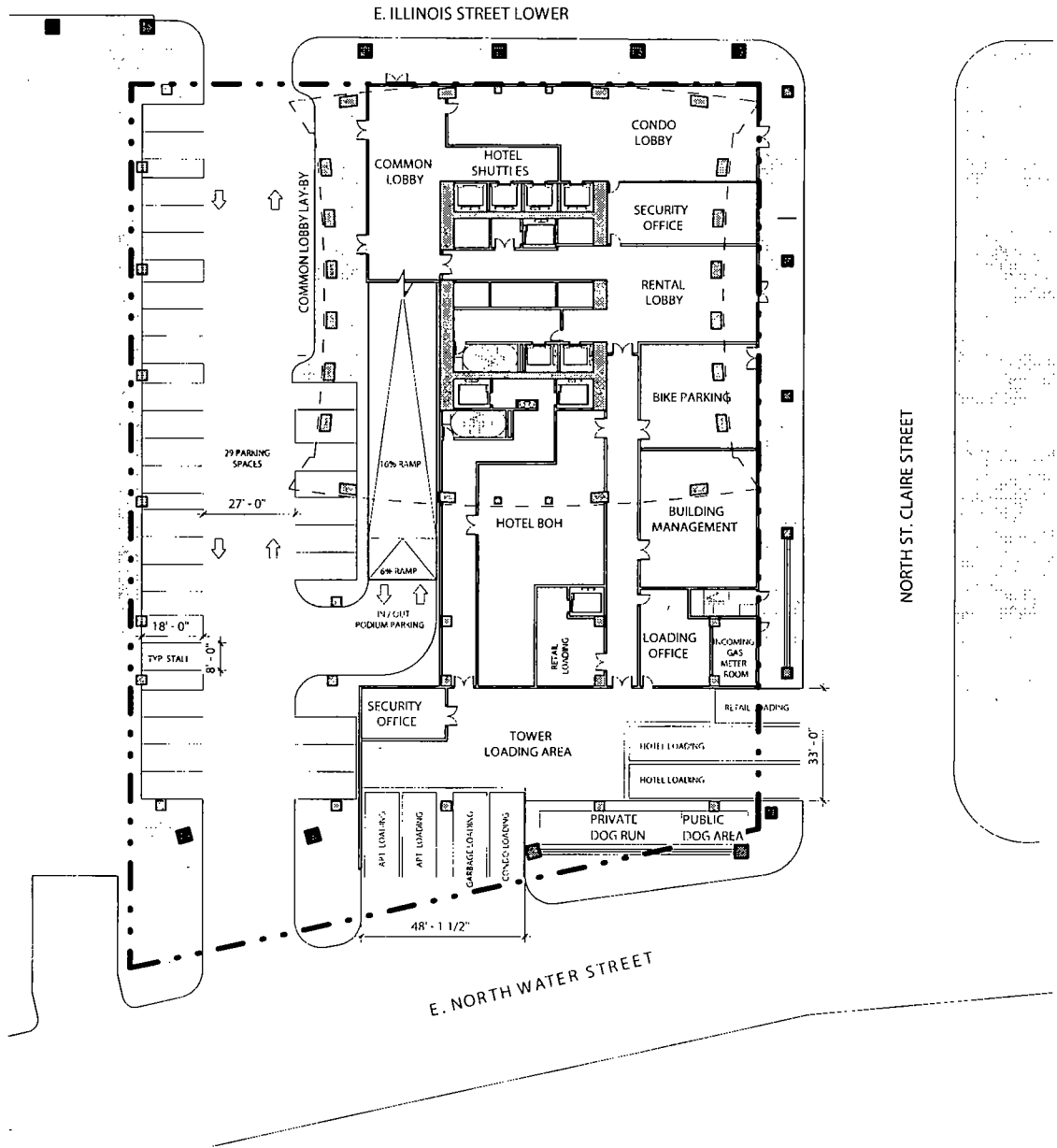

Applicant: Tribune Tower East (Chicago) Owner, LLC
Address: 421-51 N. Michigan Ave., 137-209 E. Illinois & 458-78 N. Cityfront Plaza Dr.
Introduced: January 15, 2020
CPC: May 08, 2020

SUB-AREA B - UPPER STREET LEVEL PLAN

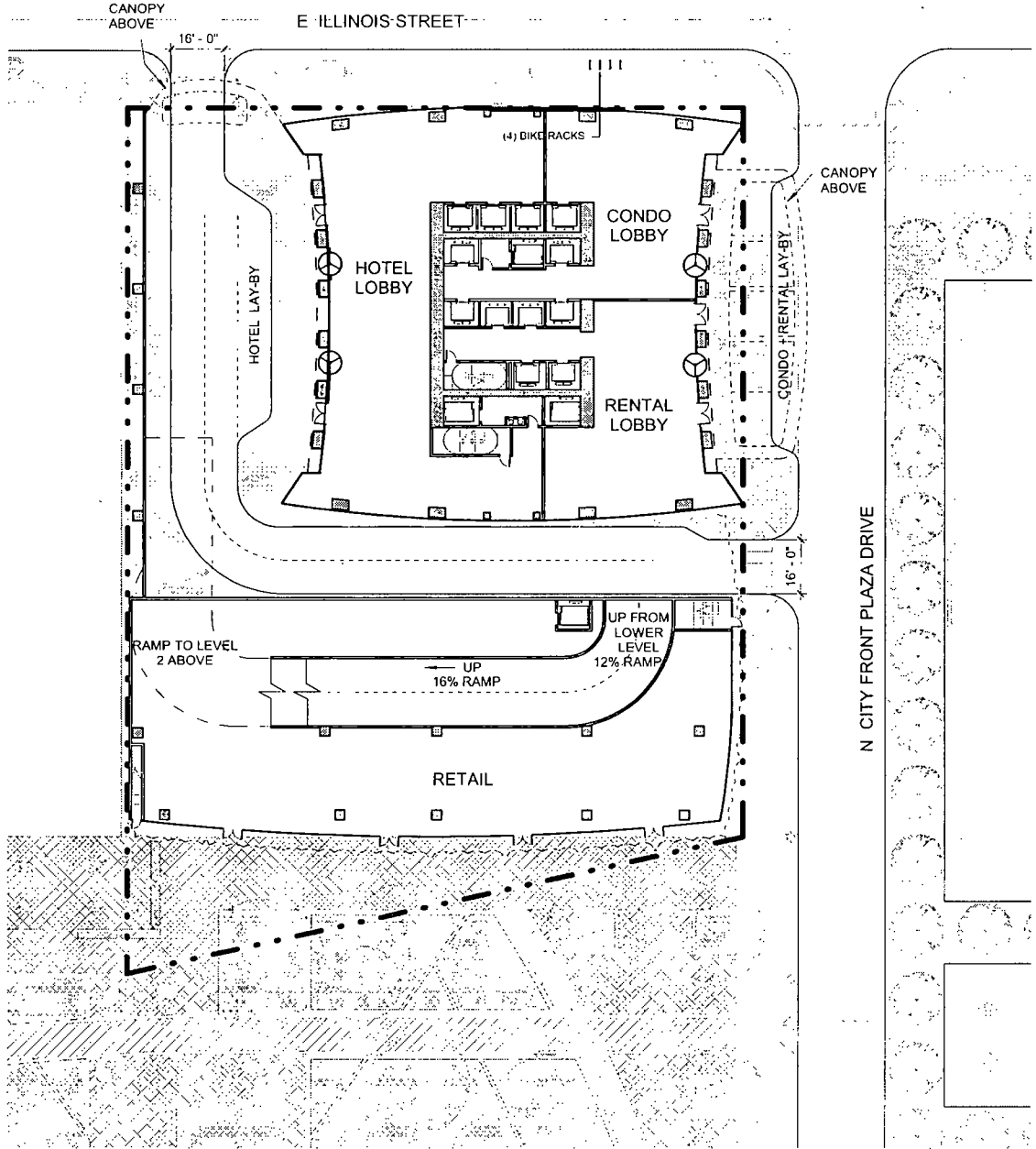

Applicant: Tribune Tower East (Chicago) Owner, LLC
Address: 421-51 N. Michigan Ave., 137-209 E. Illinois & 458-78 N Cityfront Plaza Dr.
Introduced: January 15, 2020
CPC: May 08, 2020

0' 25' 50'

SUB-AREA B - LEVEL 02 PLAN

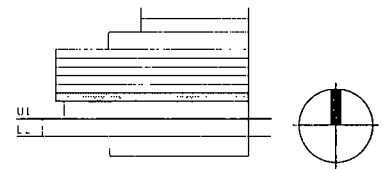
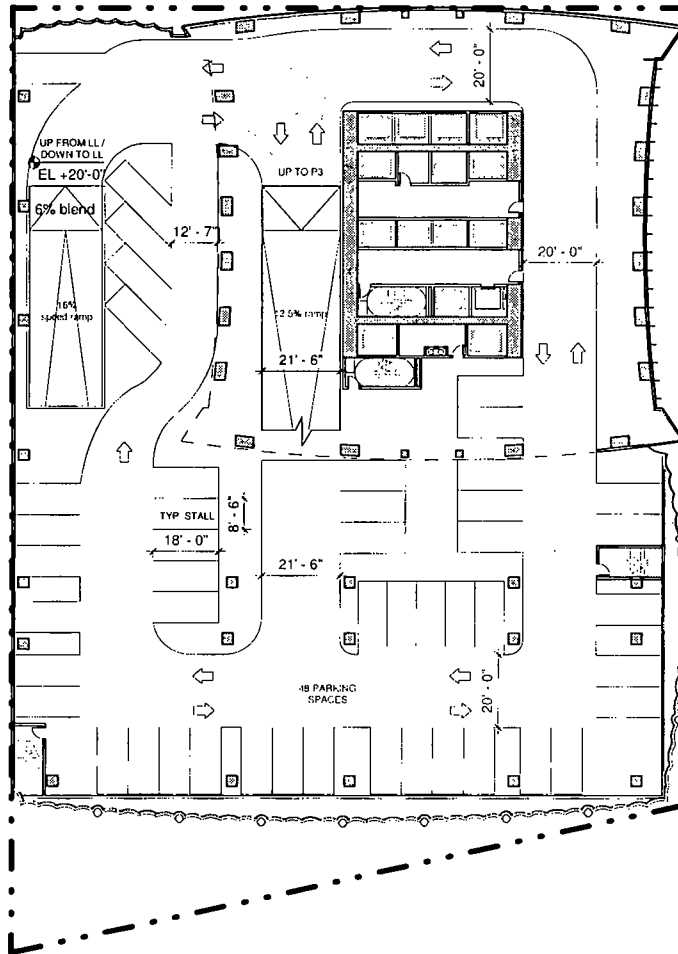

Applicant: Tribune Tower East (Chicago) Owner, LLC
Address: 421-51 N. Michigan Ave., 137-209 E. Illinois & 458-78 N. Cityfront Plaza Dr.
Introduced: January 15, 2020
CPC: May 08, 2020

0' 25' 50'

SUB-AREA B - LEVELS 03-06 TYP. PARKING PLAN

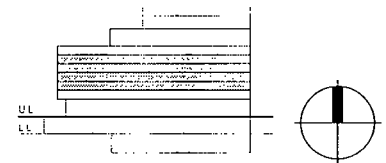
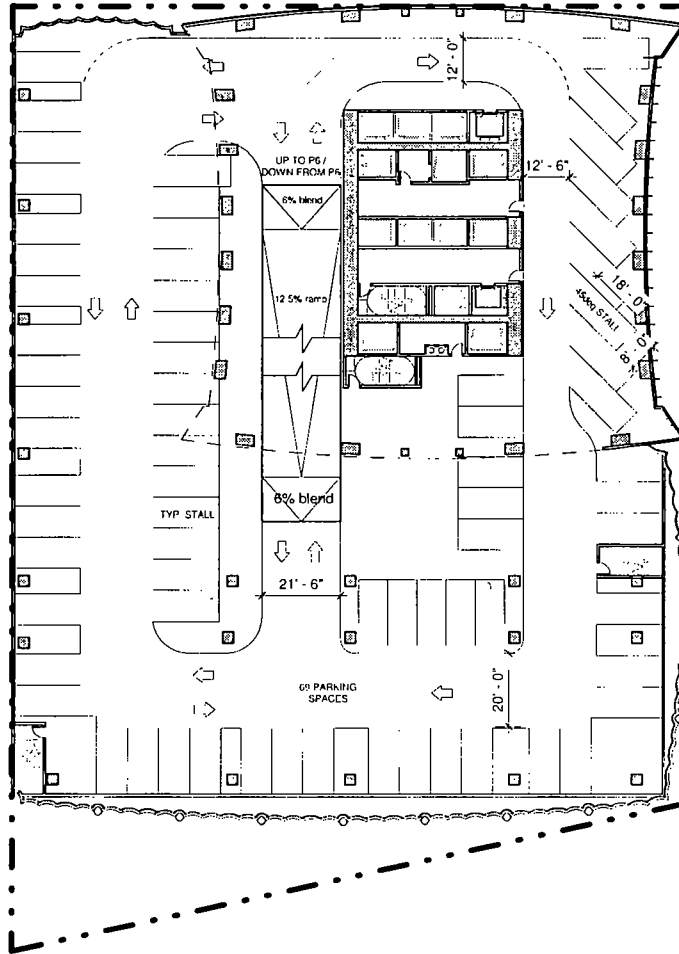

Applicant: Tribune Tower East (Chicago) Owner, LLC
Address: 421-51 N. Michigan Ave., 137-209 E. Illinois & 458-78 N: Cityfront Plaza Dr.
Introduced: January 15, 2020
CPC: May 08, 2020

0' 25' 50'
32

SUB-AREA B - LEVEL 07 PLAN

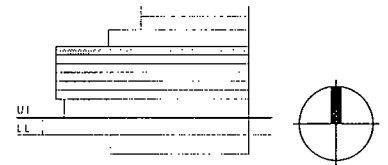
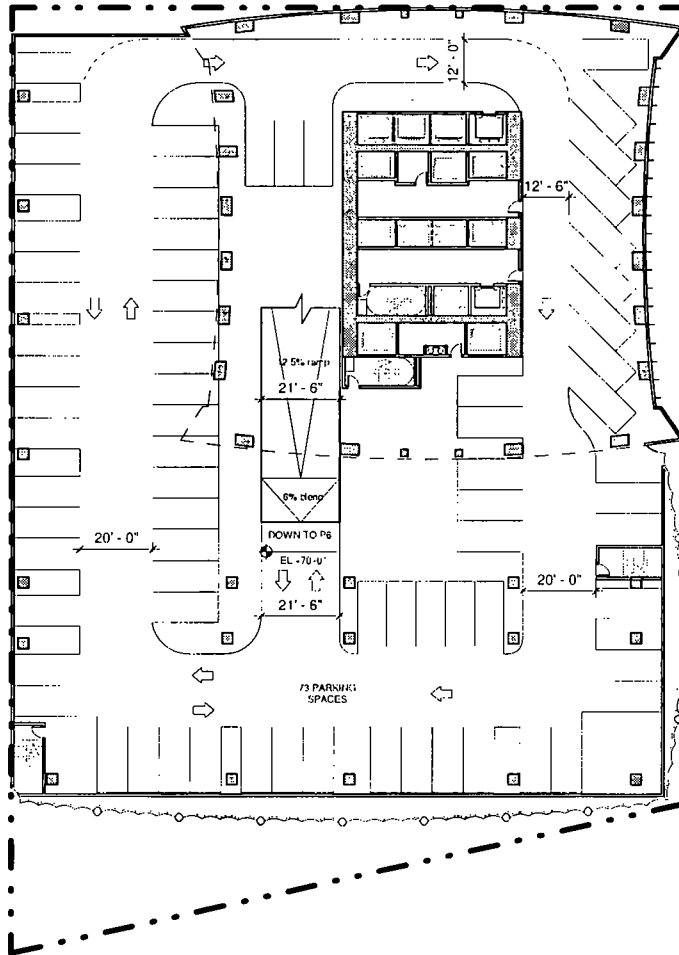

Applicant: Tribune Tower East (Chicago) Owner, LLC
Address: 421-51 N. Michigan Ave., 137-209 E. Illinois & 458-78 N. Cityfront Plaza Dr.
Introduced: January 15, 2020
CPC: May 08, 2020

0' 25' 50'

SUB-AREA B - LANDSCAPE PLAN

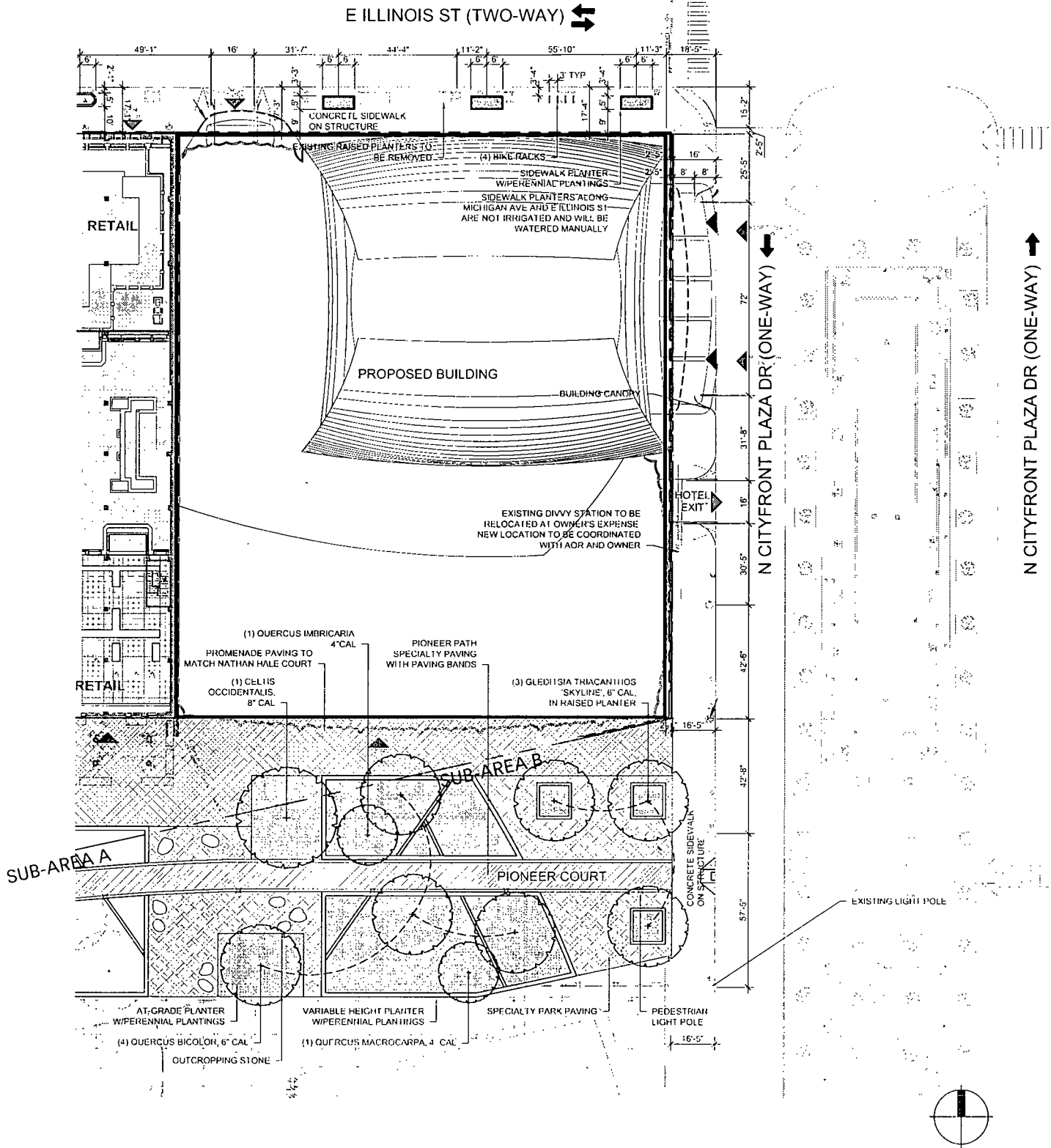

Applicant: Tribune Tower East (Chicago) Owner, LLC
 Address: 421-51 N. Michigan Ave., 137-209 E. Illinois & 458-78 N. Cityfront Plaza Dr.
 Introduced: January 15, 2020
 CPC: May 08, 2020

0' 25' 50'

SUB-AREA B - DETAILS & PLANT LIST

PLANT SCHEDULE - SUB-AREA B					
QTY	BOTANICAL NAME	COMMON NAME	ROOT	SIZE	REMARKS
1	<i>Celtis occidentalis</i>	Hackberry Tree	B&B	8" cal	matching heads
3	<i>Gleditsia triacanthos 'Skyline'</i>	Skyline Honey Locust	B&B	6" cal	matching heads
4	<i>Quercus bicolor</i>	Swamp White Oak	B&B	6" cal	matching heads
1	<i>Quercus imbricaria</i>	Shingle Oak	B&B	6" cal	matching heads
1	<i>Quercus macrocarpa</i>	Bur Oak	B&B	6" cal	matching heads

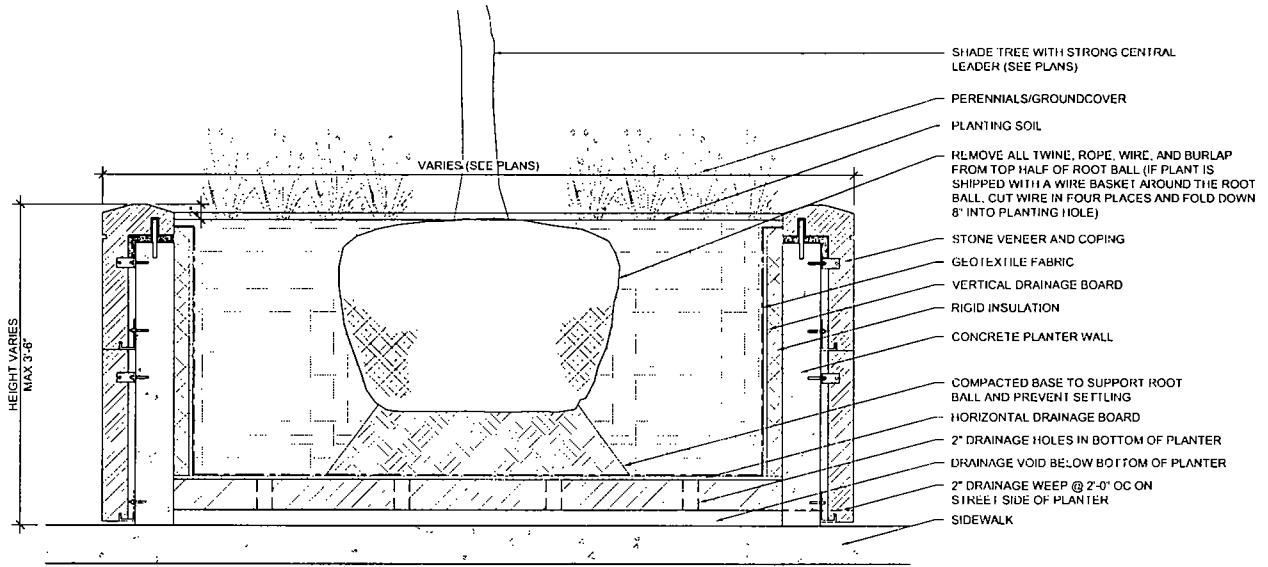

1 **SIDEWALK PLANTER W/TREE SECTION**
1/2" = 1'-0"

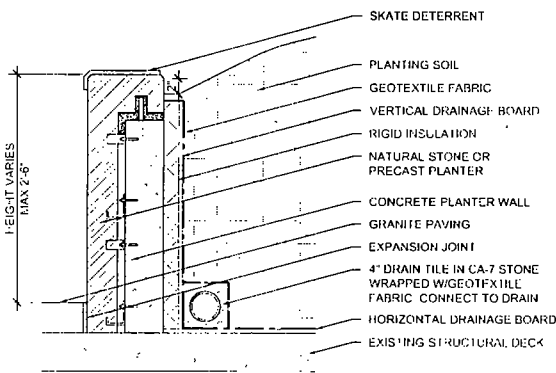

2 **RAISED PLANTER SECTION**
1/2" = 1'-0"

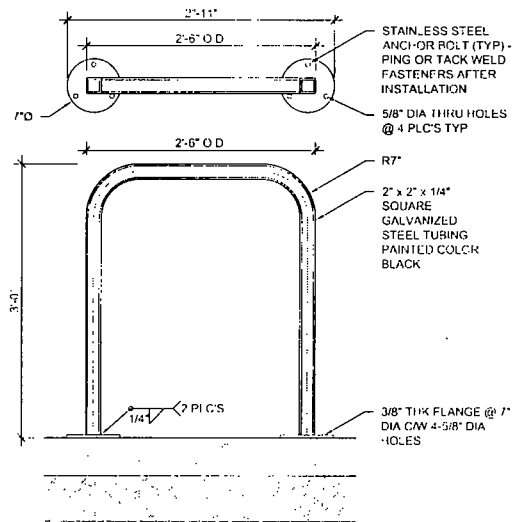

3 **BIKE RACK DETAIL**
1/2" = 1'-0"

Applicant Tribune Tower East (Chicago) Owner, LLC
 Address: 421-51 N. Michigan Ave., 137-209 E. Illinois & 458-78 N. Cityfront Plaza Dr.
 Introduced: January 15, 2020
 CPC: May 08, 2020

SUB-AREA B - OPEN SPACE PLAN

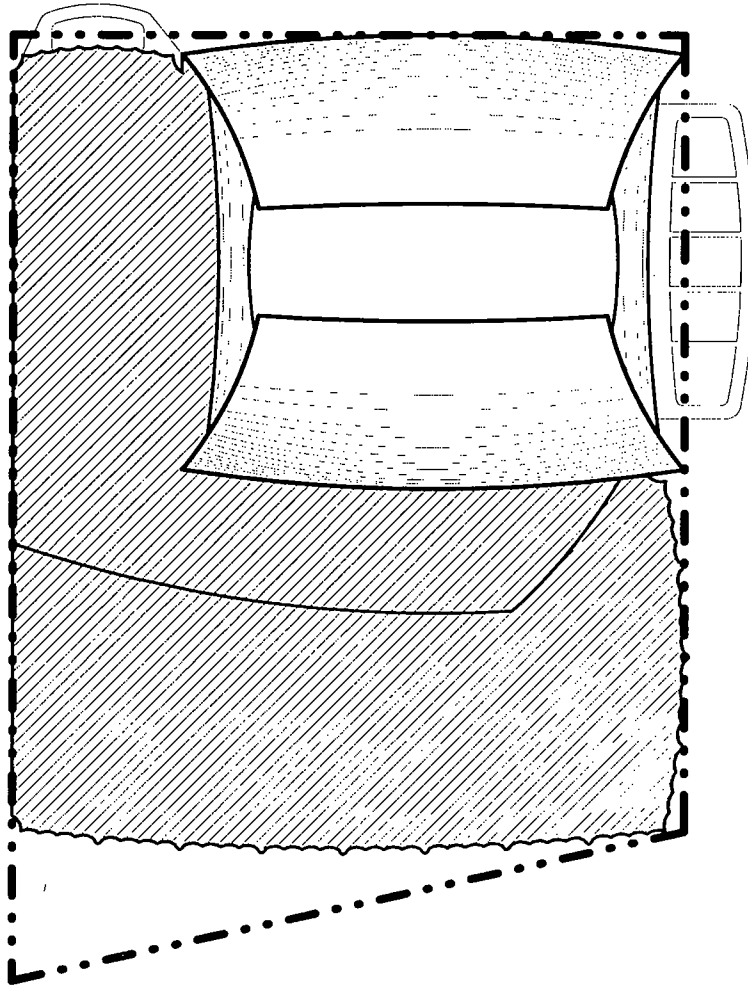

Open Spaces		SF
Total Number of Residential Units		564
Required Open Space Area (36 SF/Unit)		20,304
Provided Open Space Areas		
Level 08 Roof Deck		13,231
Level 09 Sun Deck		11,028
	Total	24,259
Resulting Open Space Area per Unit		43



Applicant: Tribune Tower East (Chicago) Owner, LLC
 Address: 421-51 N. Michigan Ave., 137-209 E. Illinois & 458-78 N. Cityfront Plaza Dr.
 Introduced: January 15, 2020
 CPC: May 08, 2020

0' 25' 50'

SUB-AREA B - EAST ELEVATION

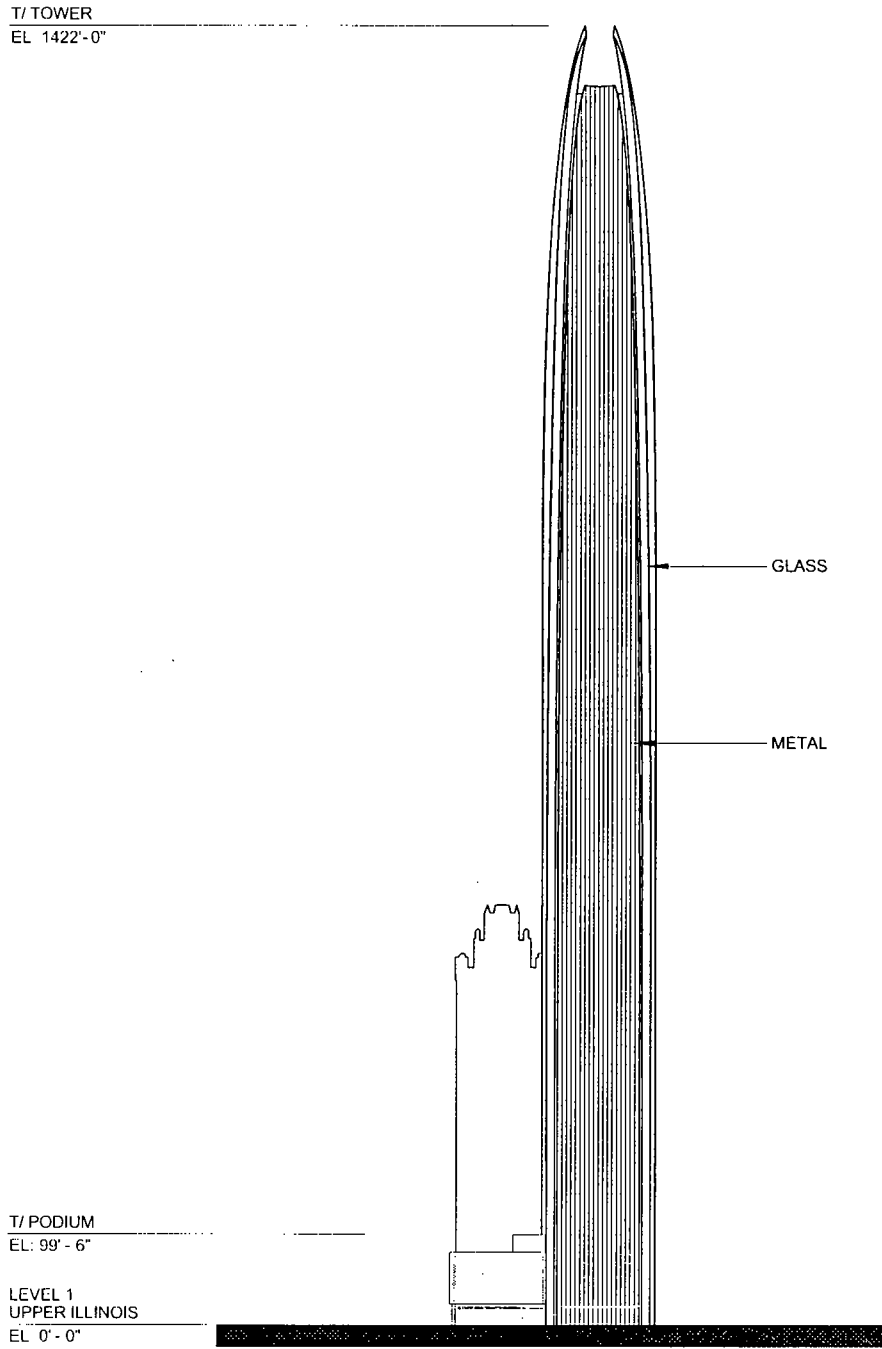

Applicant: Tribune Tower East (Chicago) Owner, LLC
Address: 421-51 N. Michigan Ave., 137-209 E. Illinois & 458-78 N. Cityfront Plaza Dr.
Introduced January 15, 2020
CPC: May 08, 2020

0' 100' 200'

SUB-AREA B - SOUTH ELEVATION

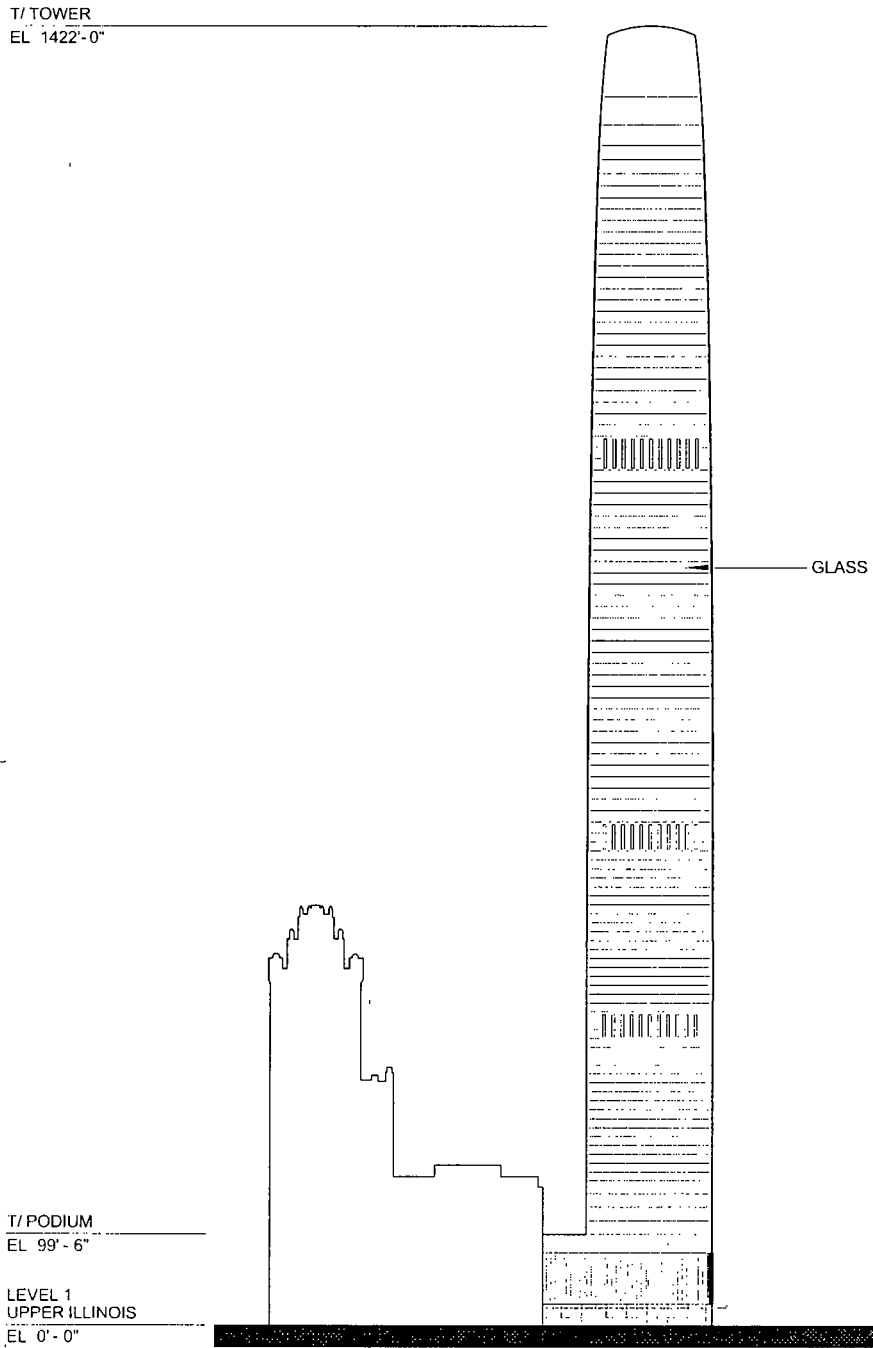

Applicant: Tribune Tower East (Chicago) Owner, LLC
Address: 421-51 N Michigan Ave., 137-209 E. Illinois & 458-78 N. Cityfront Plaza Dr.
Introduced: January 15, 2020
CPC: May 08, 2020

0' 100' 200'
38

SUB-AREA B - WEST ELEVATION

T/ TOWER
EL 1422'-0"

LEVEL 1
UPPER ILLINOIS
EL 0'-0"

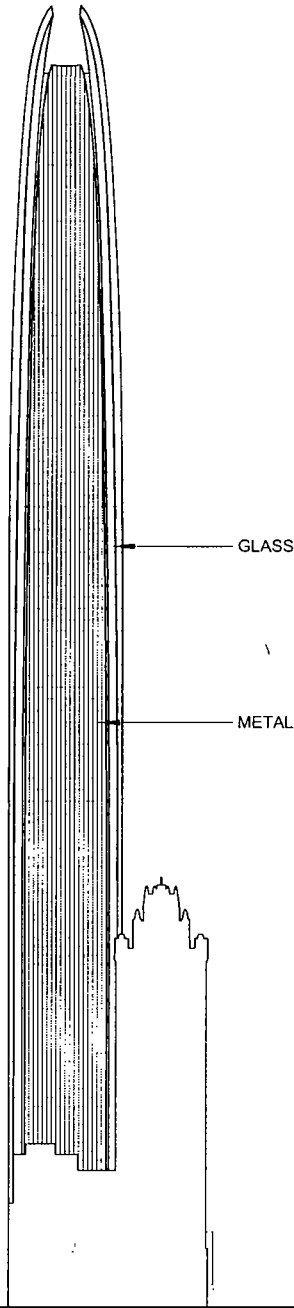

Applicant: Tribune Tower East (Chicago) Owner, LLC
Address: 421-51 N. Michigan Ave., 137-209 E. Illinois & 458-78 N. Cityfront Plaza Dr.
Introduced: January 15, 2020
CPC: May 08, 2020

0' 100' 200'

SUB-AREA B - NORTH ELEVATION

T/ TOWER
EL 1422'-0"

T/ PODIUM
EL 99'-6"

LEVEL 1
UPPER ILLINOIS
EL 0'-0"

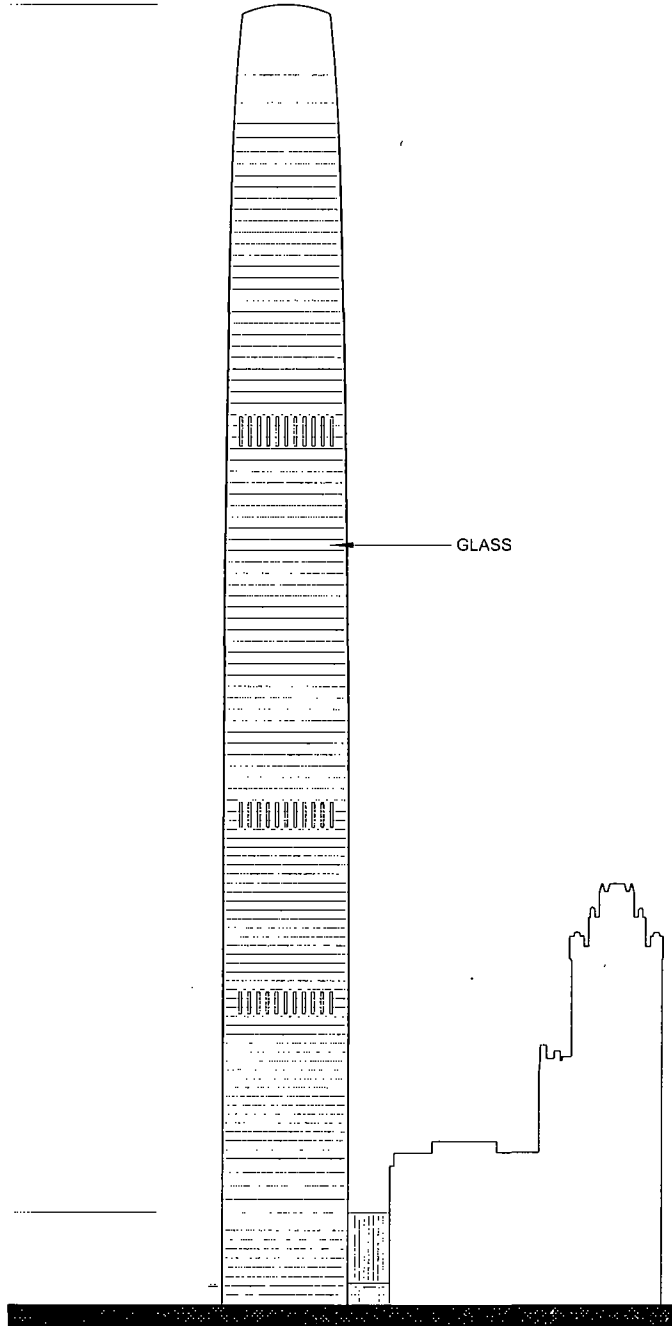

Applicant: Tribune Tower East (Chicago) Owner, LLC
Address: 421-51 N Michigan Ave., 137-209 E. Illinois & 458-78 N. Cityfront Plaza Dr.
Introduced: January 15, 2020
CPC May 08, 2020

0' 100' 200'
40

SUB-AREA B - EAST/WEST SECTION

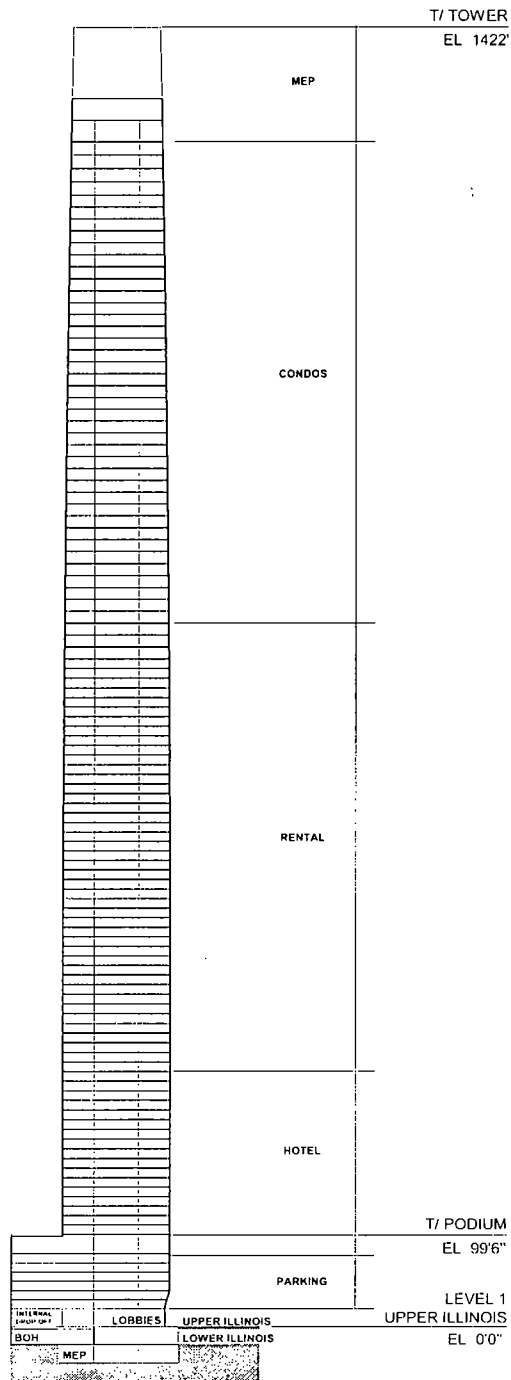

Applicant: Tribune Tower East (Chicago) Owner, LLC
Address: 421-51 N. Michigan Ave., 137-209 E. Illinois & 458-78 N. Cityfront Plaza Dr.
Introduced: January 15, 2020
CPC: May 08, 2020

0' 100' 200'

SUB-AREA B - NORTH/SOUTH SECTION

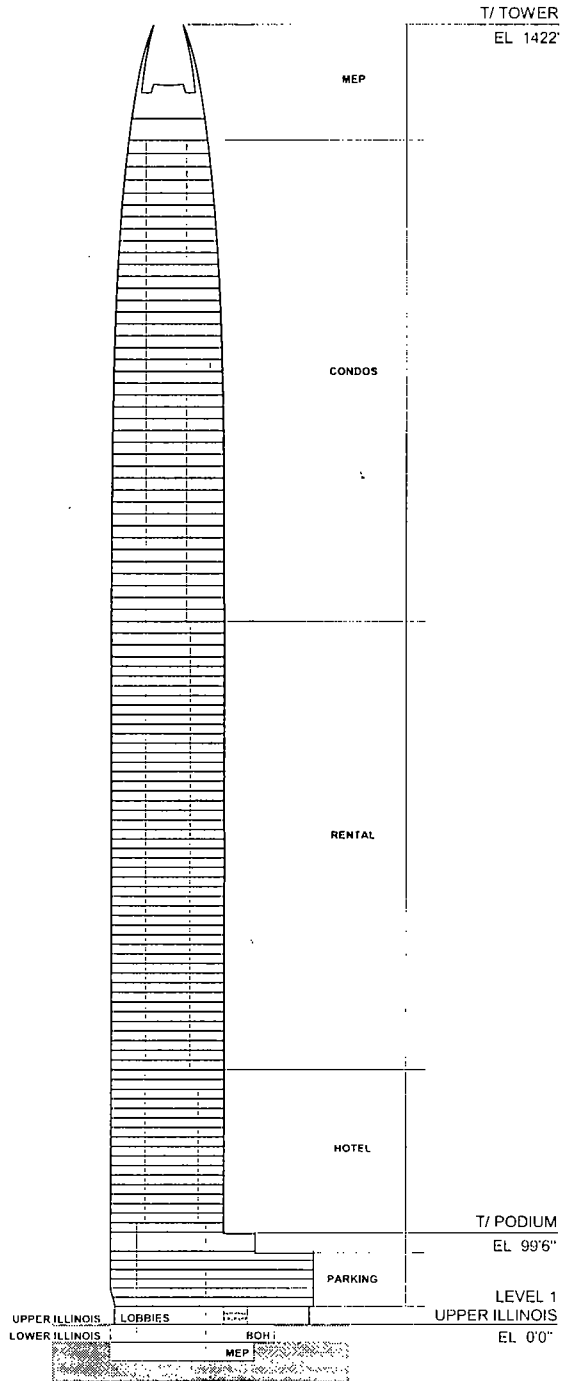

Applicant: Tribune Tower East (Chicago) Owner, LLC
Address: 421-51 N. Michigan Ave., 137-209 E. Illinois & 458-78 N. Cityfront Plaza Dr.
Introduced: January 15, 2020
CPC: May 08, 2020

0' 100' 200'
42

SUB-AREA C - LOWER STREET LEVEL PLAN

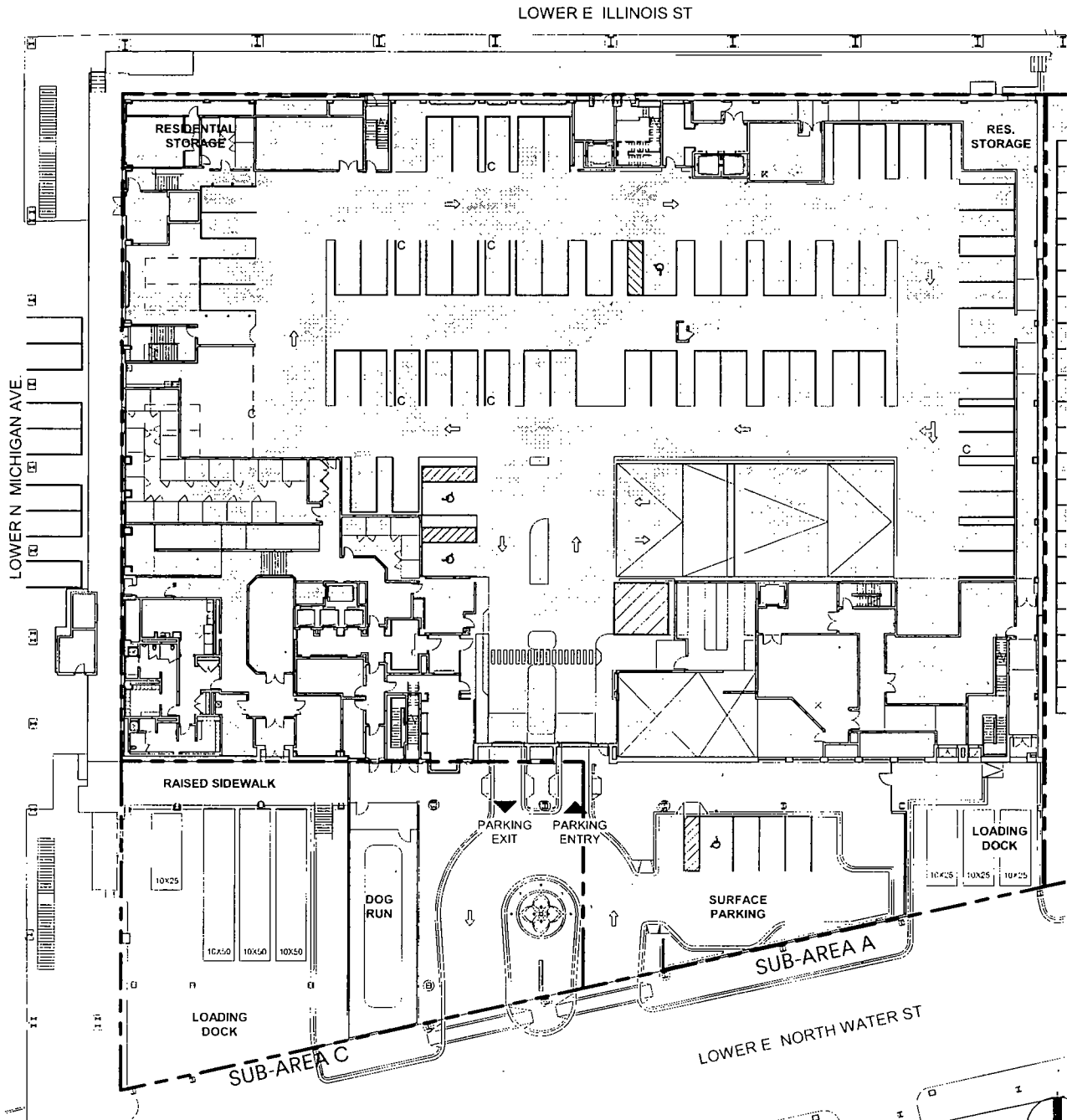

Applicant Tribune Tower East (Chicago) Owner, LLC
Address: 421-51 N Michigan Ave., 137-209 E. Illinois & 458-78 N. Cityfront Plaza Dr.
Introduced: January 15, 2020
CPC: May 08, 2020

0' 25' 50'

SUB-AREA C - UPPER STREET LEVEL PLAN

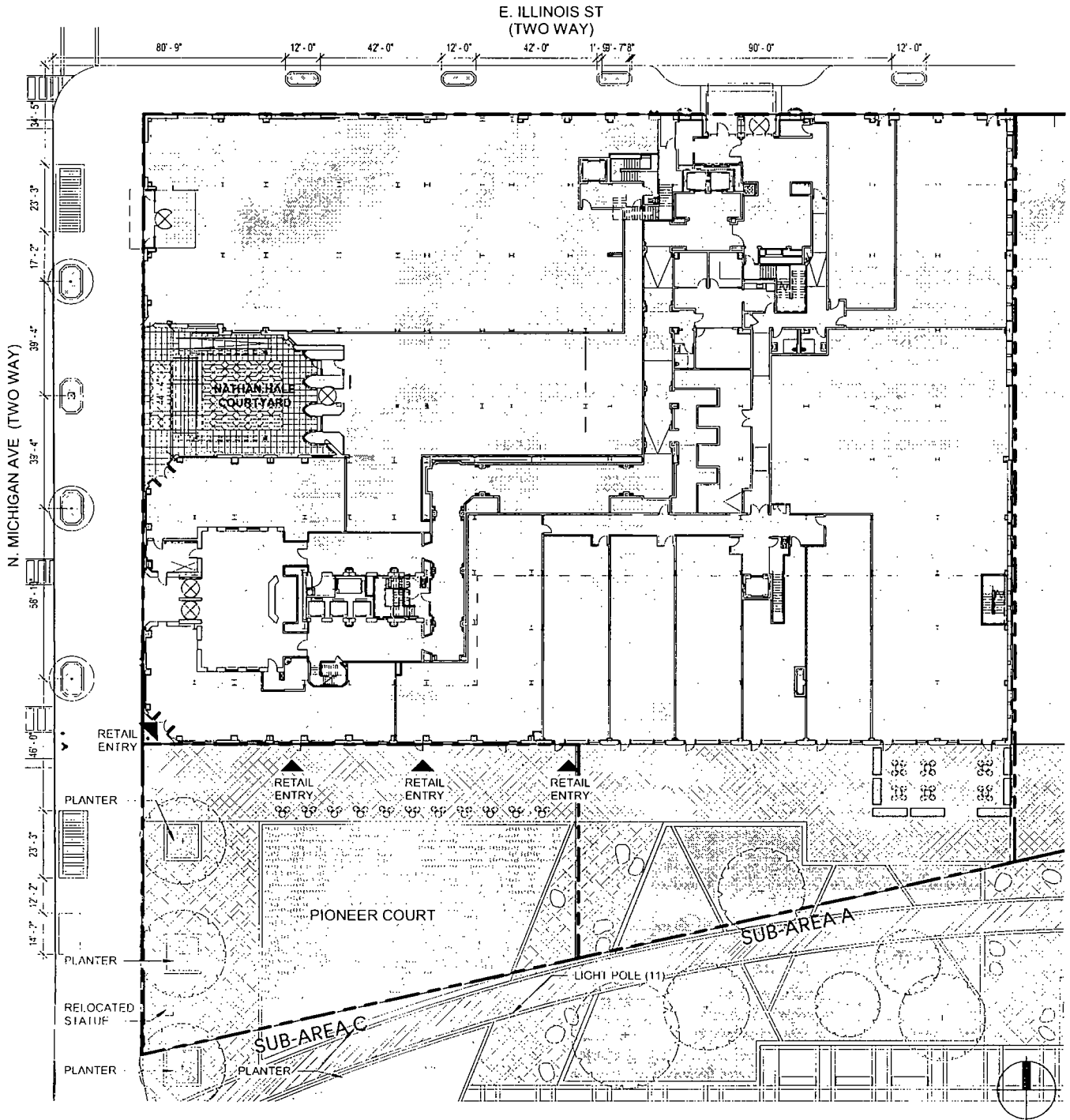

Applicant: Tribune Tower East (Chicago) Owner, LLC
Address: 421-51 N. Michigan Ave., 137-209 E. Illinois & 458-78 N. Cityfront Plaza Dr.
Introduced: January 15, 2020
CPC: May 08, 2020

0' 25' 50'

SUB-AREA C - LANDSCAPE PLAN

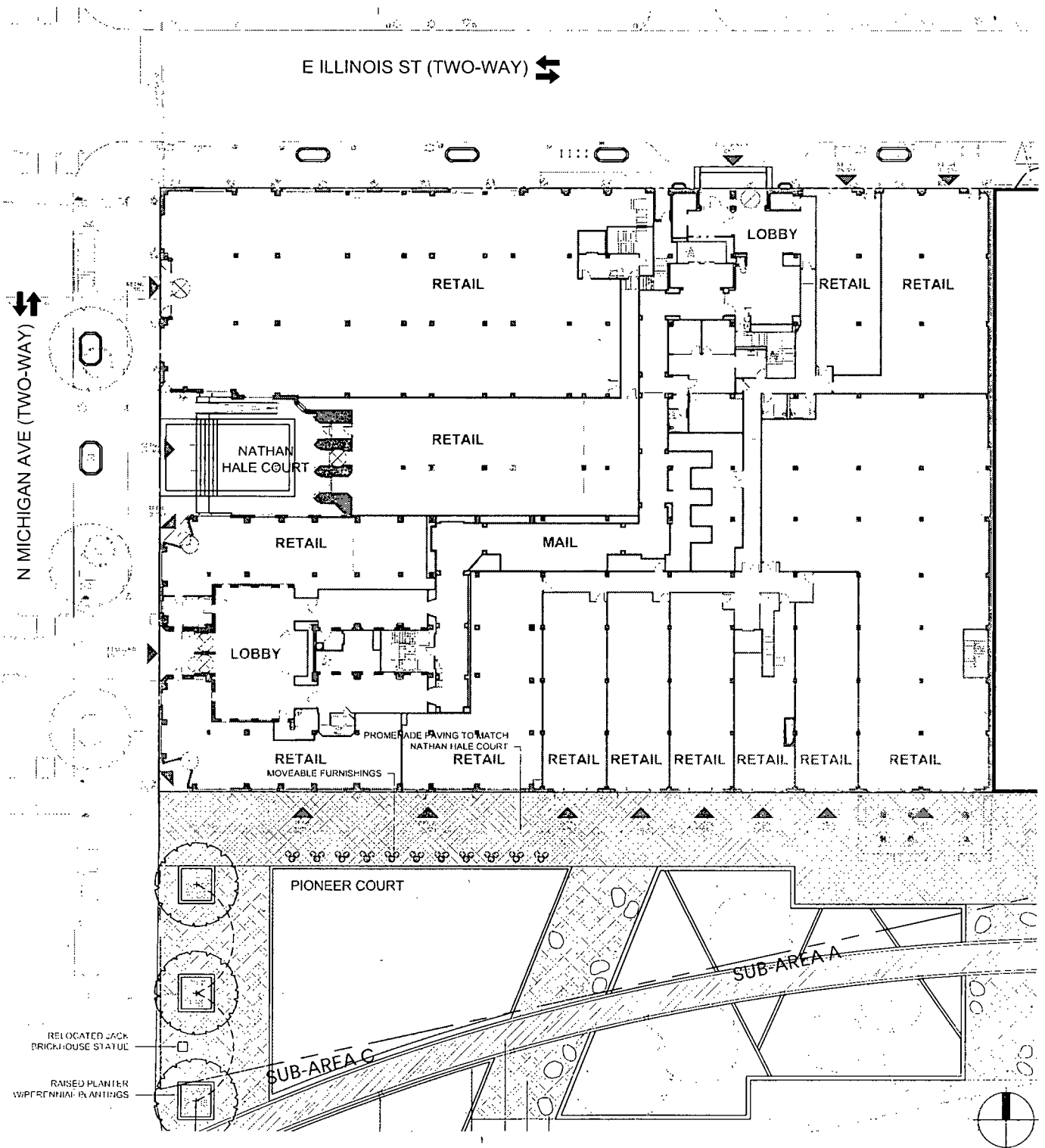

Applicant: Tribune Tower East (Chicago) Owner, LLC
Address: 421-51 N. Michigan Ave., 137-209 E. Illinois & 458-78 N. Cityfront Plaza Dr.
Introduced: January 15, 2020
CPC: May 08, 2020

0' 25' 50'

SUB-AREA C - DETAILS & PLANT LIST

PLANT SCHEDULE - SUB-AREA C					
QTY	BOTANICAL NAME	COMMON NAME	ROOT	SIZE	REMARKS
3	<i>Gleditsia triacanthos</i> 'Skyline'	Skyline Honey Locust	B&B	6" cal	matching heads

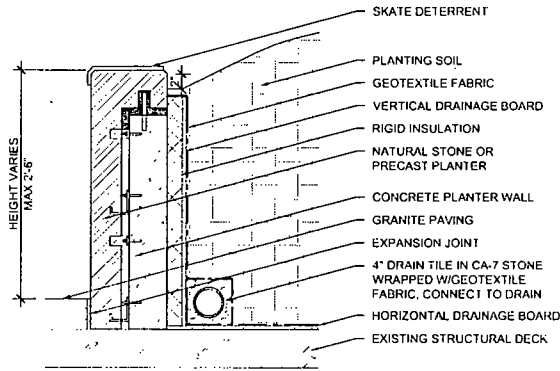

1 **RAISED PLANTER SECTION**
1/2" = 1'-0"

Applicant: Tribune Tower East (Chicago) Owner, LLC
 Address: 421-51 N. Michigan Ave., 137-209 E. Illinois & 458-78 N. Cityfront Plaza Dr.
 Introduced January 15, 2020
 CPC: May 08, 2020



DEPARTMENT OF PLANNING AND DEVELOPMENT
CITY OF CHICAGO

MEMORANDUM

To: Alderman Tom Tunney
Chairman, City Council Committee on Zoning

From: 
Maurice D. Cox
Chicago Plan Commission

Date: May 8, 2020

Re: Proposed Residential Business Planned Development (421 North Michigan Avenue)

On May 8, 2020, the Chicago Plan Commission recommended approval of the proposed planned development submitted by, Tribune Tower East (Chicago) Owner, LLC. A copy of the proposed planned development is attached. I would very much appreciate your assistance in having this introduced at the next possible City Council Committee on Zoning.

Also enclosed is a copy of the staff report to the Plan Commission which includes the Department of Planning and Development, Bureau of Zoning and Land Use recommendation and a copy of the resolution. If you have any questions in this regard, please do not hesitate to contact Noah Szafraniec at 312-744-5798.

Cc: Steve Valenziano
PD Master File (Original PD, copy of memo)