



Office of the Chicago City
Clerk



O2011-7028

- Office of the City Clerk

City Council Document Tracking Sheet

Meeting Date:	9/8/2011
Sponsor(s):	City Clerk Mendoza
Type:	Ordinance
Title:	Zoning Reclassification App No. 17328
Committee(s) Assignment:	Committee on Zoning, Landmarks and Building Standards

ORDINANCE

BE IT ORDAINED BY THE CITY COUNCIL OF THE CITY OF CHICAGO:

SECTION 1. Title 17 of the Municipal Code of Chicago, the Chicago Zoning Ordinance is hereby amended by changing all of the C3-1, Commercial, Manufacturing and Employment District and M2-1, Light Industry District

District symbols as shown on Map No. 6-K

in the area bounded by:

A line 25 feet South of and parallel to Chicago Burlington & Quincy Railroad; South Pulaski Road; West 24th Street; the public alley next West of and parallel to South Pulaski Road.

To those of a C3-1, Commercial, Manufacturing and Employment District

SECTION 2. This Ordinance takes effect after its passage and approval.

Common address of property: 2344 -60 South Pulaski Road, Chicago IL.

17328
INT. D ME
9-8-11

CITY OF CHICAGO

APPLICATION FOR AN AMENDMENT TO
THE CHICAGO ZONING ORDINANCE

1. ADDRESS of the property Applicant is seeking to rezone:

2344-60 South Pulaski Road, Chicago

2. Ward Number that property is located in: 22 Ward

3. APPLICANT Blue Kangaroo, LLC

ADDRESS 300 West North Avenue

CITY Lombard STATE Illinois ZIP CODE 60148

PHONE 630-827-6306 CONTACT PERSON Neil Polifka

4. Is the Applicant the owner of the property? YES NO

If the Applicant is not the owner of the property, please provide the following information regarding the owner and attach written authorization from the owner allowing the Applicant to proceed.

OWNER Blue Kangaroo, LLC

ADDRESS 300 West North Avenue

CITY Lombard STATE IL ZIP CODE 60148

PHONE 630-827-6306 CONTACT PERSON Neil Polifka

5. If the Applicant/Owner of the property has obtained a lawyer as their representative for the rezoning, please provide the following information:

ATTORNEY Law Office of Mark J. Kupiec & Assoc.

ADDRESS 77 West Washington St. Ste. 1801

CITY Chicago STATE Illinois ZIP CODE 60602

PHONE 312-541-1878 FAX 312-641-1745

6. If the applicant is a legal entity (Corporation, LLC, Partnership, etc.) please provide the names of all owners disclosed on the Economic Disclosure Statements.

Gordon S. Hughes – sole member and manager

7. On what date did the owner acquire legal title to the subject property? August, 2011

8. Has the present owner previously rezoned this property? If yes, when?
~~NO~~ DECEMBER 2010

9. Present Zoning District M2-1 & C3-1 Proposed Zoning District C3-1

10. Lot size in square feet (or dimensions) approximately 3,100 square feet

11. Current Use of the property vacant

12. Reason for rezoning the property To establish a coin operated laundry

13. Describe the proposed use of the property after the rezoning. Indicate the number of dwelling units; number of parking spaces; approximate square footage of any commercial space; and height of the proposed building. (BE SPECIFIC)

To build one story commercial building for a coin operated laundry; to be built within the
maximum allowable height, 29 parking spaces; approximately 6,239 square feet of commercial
space

14. On May 14th, 2007, the Chicago City Council passes the Affordable Requirements Ordinance (ARO) that requires on-site affordable housing units or a financial contribution if residential housing projects receive a zoning change under certain circumstances. Based on the lot size of the project in question and the proposed zoning classification, is this project subject to the Affordable Requirements Ordinance? (See Fact Sheet for more information)

YES _____ NO X _____

COUNTY OF COOK
STATE OF ILLINOIS

Gordon S. Hughes, being first duly sworn on oath, states that all of the above statements and the statements contained in the documents submitted herewith are true and correct.

X Gordon S. Hughes
Signature of Applicant

Subscribed and Sworn to before me this
21st day of August, 2011.

Tammy Ann Stern
Notary Public

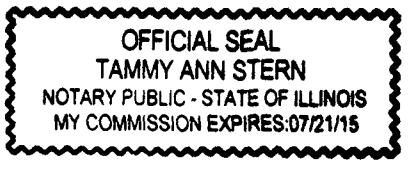

For Office Use Only

Date of Introduction: _____

File Number: _____

Ward: _____

SUPPLEMENTAL SUBMISSION
 TYPE 1 REZONING FOR
 2344-60 SOUTH PULASKI ROAD
 CHICAGO, ILLINOIS

PROJECT DESCRIPTION:	Zoning Change from M2-1 and C3-1 to C3-1
Proposed land use:	To build a new one story building to establish a coin operated laundry at 2344-60 South Pulaski
Floor Area Ratio:	Lot area is 21,012 sf Building gross area is 5,382 sf. Proposed FAR = $5,382/21,012 = .26$ FAR
Density:	Not applicable –commercial use (coin operated laundry)
Off- Street parking:	29 parking spaces
Set Backs	Front: 7' Side: 7' Rear: 1'-1".
Building height:	18'-4"

**AFFIDAVIT
(Section 17-13-0107)**

Date: September 1, 2011

Honorable Daniel S. Solis
Chairman, Committee on Zoning
121 North LaSalle Street
Room 304, City Hall
Chicago, Illinois 60602

The undersigned, Danuta Sawicki, being first duly sworn on oath, deposes and states the following:

The undersigned certifies that he has complied with the requirements of Section 17-13-0107 of the Chicago Zoning Ordinance, by sending written notice to such property owners who appear to be the owners of the property within the subject area not solely owned by the applicant, and to the owners of all property within 250 feet in each direction of the lot line of the subject property, exclusive of public roads, streets, alleys, and other public ways, or a total distance limited to 400 feet. Said written notice was sent by First Class U.S. Mail, no more than 30 days before filling the application

The undersigned certifies that the notice contained the address of the property sought to be rezoned; a statement of the intended use of the property; the name and address of the applicant; the name and address of the owner; and a statement that the applicant intends to file the application for a change in zoning on approximately September 8, 2011.

The undersigned certifies that the applicant has made a bona fide effort to determine the addresses of the parties to be notified under Section 17-13-0107 of the Chicago Zoning Ordinance, and that the accompanying list of names and addresses of surrounding property owners within 250 feet of the subject site is a complete list containing the names and addresses of the people required to be served.

By: Danuta Sawicki, Agent

Subscribed and sworn to before me this 1st day of September, 2011.

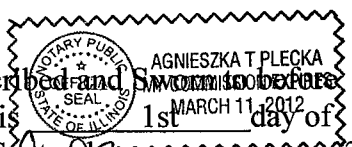

[Signature]
Notary Public

LAW OFFICES
MARK J. KUPIEC & ASSOCIATES
SUITE 1801
77 W. WASHINGTON STREET
CHICAGO, IL 60602-3184

TELEPHONE (312) 541-1878
FACSIMILE (312) 641-1745

September 1, 2011

Re: 2344-60 South Pulaski Road, Chicago, IL

Dear Property Owner or Resident:

In accordance with the requirements for an Amendment to the Chicago Zoning Ordinance, specifically Section 17-13-0107, please be informed that on or about September 8, 2011 the undersigned will file an Application for a change in zoning from M2-1, Light Industry Zoning District, to C3-1, Commercial, Manufacturing and Employment Zoning District, on behalf of the Applicant, Blue Kangaroo, LLC for the property located at 2344-60 South Pulaski Road, Chicago, Illinois.

The subject property is currently vacant. The Applicant intends to build one story commercial building at 2344-60 South Pulaski to establish a coin operated laundry at the subject property.

The applicant and the owner of the subject property is Blue Kangaroo, LLC. I am the Attorney for the Applicant and the contact person for this Application. My address is 77 West Washington Street, Ste. 1801, Chicago, Illinois, and my telephone number is (312) 541-1878.

Please note that the Applicant is not seeking to rezone or purchase your property. The Applicant is required by law to send this notice because you own property within 250 feet of the property to be rezoned.

Sincerely,

Mark J. Kupiec

MJK/ap

**CITY OF CHICAGO
ECONOMIC DISCLOSURE STATEMENT
AND AFFIDAVIT**

SECTION I -- GENERAL INFORMATION

A. Legal name of Disclosing Party submitting this EDS. Include d/b/a/ if applicable:

Blue Kangaroo, LLC.

Check ONE of the following three boxes:

Indicate whether Disclosing Party submitting this EDS is:

1. the Applicant

OR

2. a legal entity holding a direct or indirect interest in the Applicant. State the legal name of the Applicant in which Disclosing Party holds an interest: _____

OR

3. a legal entity with a right of control (see Section II.B.1.) State the legal name of the entity in which the Disclosing Party holds a right of control: _____

B. Business address of Disclosing Party: 300 West North Avenue, Lombard IL 60148

C. Telephone: _____ Fax: _____ Email: _____

D. Name of contact person: _____

E. Federal Employer Identification No. (if you have one): N/A

F. Brief description of contract, transaction or other undertaking (referred to below as the "Matter") to which this EDS pertains. (Include project number and location of property, if applicable):

Zoning Change at 2344-60 South Pulaski Road

G. Which City agency or department is requesting this EDS? Dept. of Housing and Economic Development

If the Matter is a contract being handled by the City's Department of Procurement Services, please complete the following:

Specification # N/A and Contract # N/A

SECTION II -- DISCLOSURE OF OWNERSHIP INTERESTS

A. NATURE OF DISCLOSING PARTY

1. Indicate the nature of the Disclosing Party:

- | | |
|---|---|
| <input type="checkbox"/> Person | <input checked="" type="checkbox"/> Limited liability company |
| <input type="checkbox"/> Publicly registered business corporation | <input type="checkbox"/> Limited liability partnership |
| <input type="checkbox"/> Privately held business corporation | <input type="checkbox"/> Joint venture |
| <input type="checkbox"/> Sole proprietorship | <input type="checkbox"/> Not-for-profit corporation |
| <input type="checkbox"/> General partnership | (Is the not-for-profit corporation also a 501(c)(3))? |
| <input type="checkbox"/> Limited partnership | <input type="checkbox"/> Yes <input type="checkbox"/> No |
| <input type="checkbox"/> Trust | <input type="checkbox"/> Other (please specify) |

2. For legal entities, the state (or foreign country) of incorporation or organization, if applicable:

IL

3. For legal entities not organized in the State of Illinois: Has the organization registered to do business in the State of Illinois as a foreign entity?

- Yes No N/A

B. IF THE DISCLOSING PARTY IS A LEGAL ENTITY:

1. List below the full names and titles of all executive officers and all directors of the entity.

NOTE: For not-for-profit corporations, also list below all members, if any, which are legal entities. If there are no such members, write "no members." For trusts, estates or other similar entities, list below the legal titleholder(s).

If the entity is a general partnership, limited partnership, limited liability company, limited liability partnership or joint venture, list below the name and title of each general partner, managing member, manager or any other person or entity that controls the day-to-day management of the Disclosing Party.

NOTE: Each legal entity listed below must submit an EDS on its own behalf.

Name	Title
<u>GORDON S. HUGHES</u>	<u>MANAGER</u>

2. Please provide the following information concerning each person or entity having a direct or indirect beneficial interest (including ownership) in excess of 7.5% of the Disclosing Party. Examples of such an interest include shares in a corporation, partnership interest in a partnership or joint venture,

interest of a member or manager in a limited liability company, or interest of a beneficiary of a trust, estate or other similar entity. If none, state "None." **NOTE:** Pursuant to Section 2-154-030 of the Municipal Code of Chicago ("Municipal Code"), the City may require any such additional information from any applicant which is reasonably intended to achieve full disclosure.

Name	Business Address	Percentage Interest in the Disclosing Party
GORDON S. HUGHES	300 W. NORTH AVE LOMBARD, IL 60148	100%

SECTION III -- BUSINESS RELATIONSHIPS WITH CITY ELECTED OFFICIALS

Has the Disclosing Party had a "business relationship," as defined in Chapter 2-156 of the Municipal Code, with any City elected official in the 12 months before the date this EDS is signed?

Yes No

If yes, please identify below the name(s) of such City elected official(s) and describe such relationship(s):

N/A

SECTION IV -- DISCLOSURE OF SUBCONTRACTORS AND OTHER RETAINED PARTIES

The Disclosing Party must disclose the name and business address of each subcontractor, attorney, lobbyist, accountant, consultant and any other person or entity whom the Disclosing Party has retained or expects to retain in connection with the Matter, as well as the nature of the relationship, and the total amount of the fees paid or estimated to be paid. The Disclosing Party is not required to disclose employees who are paid solely through the Disclosing Party's regular payroll.

"Lobbyist" means any person or entity who undertakes to influence any legislative or administrative action on behalf of any person or entity other than: (1) a not-for-profit entity, on an unpaid basis, or (2) himself. "Lobbyist" also means any person or entity any part of whose duties as an employee of another includes undertaking to influence any legislative or administrative action.

If the Disclosing Party is uncertain whether a disclosure is required under this Section, the Disclosing Party must either ask the City whether disclosure is required or make the disclosure.

Name (indicate whether retained or anticipated to be retained)	Business Address	Relationship to Disclosing Party (subcontractor, attorney, lobbyist, etc.)	Fees (indicate whether paid or estimated.) NOTE: "hourly rate" or "t.b.d" is not an acceptable response.
Kupiec & Assoc.	77 West Washington St. Ste. 1801, Chicago Chicago IL 60602	Attorneys	\$3,500

(Add sheets if necessary)

Check here if the Disclosing party has not retained, nor expects to retain, any such persons or entities.

SECTION V – CERTIFICATIONS

A. COURT-ORDERED CHILD SUPPORT COMPLIANCE

Under Municipal Code Section 2-92-415, substantial owners of business entities that contract with the City must remain in compliance with their child support obligations throughout the contract's term.

Has any person who directly or indirectly owns 10% or more of the Disclosing Party been declared in arrearage on any child support obligations by any Illinois court of competent jurisdiction?

Yes No No person directly or indirectly owns 10% or more of the Disclosing Party.

If "Yes," has the person entered into a court-approved agreement for payment of all support owed and is the person in compliance with that agreement?

Yes No

B. FURTHER CERTIFICATIONS

1. Pursuant to Municipal Code Chapter 1-23, Article I ("Article I") (which the Applicant should consult for defined terms (e.g., "doing business") and legal requirements), if the Disclosing Party Submitting this EDS is the Applicant and is doing business with the City, then the Disclosing Party Certified as follows: (i) neither the Applicant nor any controlling person is currently indicted or charged With, or has admitted guilt of, or has ever been convicted of, or placed under supervision for, any criminal offense involving actual, attempted, or conspiracy to commit bribery, theft, fraud, forgery, perjury, dishonesty, or deceit against an officer or employee of the City or any sister agency; and (ii) the Applicant understands and acknowledges that compliance with Article I is a continuing requirement for doing business with the City. NOTE: If Article I applies to the Applicant, the permanent compliance timeframe in Article I supersedes some five-year compliance timeframes in certifications 2 and 3 below.

2. The Disclosing Party and, if the Disclosing Party is a legal entity, all of those persons or entities identified in Section II.B.1. of this EDS:
 - a. are not presently debarred, suspended, proposed for debarment, declared ineligible or voluntarily excluded from any transactions by any federal, state or local unit of government;
 - b. have not, within a five-year period preceding the date of this EDS, been convicted of a criminal offense, adjudged guilty, or had a civil judgment rendered against them in connection with: obtaining, attempting to obtain, or performing a public (federal, state or local) transaction or contract under a public transaction; a violation of federal or state antitrust statutes; fraud; embezzlement; theft; forgery; bribery; falsification; or destruction of records; making false statements; or receiving stolen property;
 - c. are not presently indicted for or criminally or civilly charged by, a governmental entity (federal, state or local) with committing any of the offenses set forth in clause B.2.b. of this Section V;
 - d. have not, within a five-year period preceding the date of this EDS, had one or more public transactions (federal, state or local) terminated for cause or default; and
 - e. have not, within a five-year period preceding the date of this EDS, been convicted, adjudged guilty, or found liable in a civil proceeding, or in any criminal or civil action, including actions concerning environmental violations, instituted by the City or by the federal government, any state, or any other unit of local government.
3. The certifications in subparts 3, 4 and 5 concern:
 - the Disclosing Party;
 - any "Contractor" (meaning any contractor or subcontractor used by the Disclosing Party in Connection with the Matter, including but not limited to all persons or legal entities disclosed under Section IV, "Disclosure of Subcontractors and Other Retained Parties");
 - any "Affiliated Entity" (meaning a person or entity that, directly or indirectly: controls the Disclosing Party, is controlled by the Disclosing Party, or is, with the Disclosing Party, under common control of another person or entity. Indicia of control include, without limitation: interlocking management or ownership; identity of interests among family members, shared facilities and equipment; common use of employees; or organization of a business entity following the ineligibility of a business entity to do business with federal or state or local government, including the City, using substantially the same management, ownership, or principals as the ineligible entity); with respect to Contractors, the term Affiliated Entity means a person or entity that directly or indirectly controls the Contractor, is controlled by it, or, with the Contractor, is under common control of another person or entity;
 - any responsible official of the Disclosing Party, any Contractor or any Affiliated Entity or any other official, agent or employee of the Disclosing Party, any Contractor or any Affiliated Entity, acting pursuant to the direction or authorization of a responsible official of the Disclosing Party, any Contractor or any Affiliated Entity (collectively "Agents").

Neither the Disclosing Party, nor any Contractor, nor any Affiliated Entity of either the Disclosing Party or any Contractor nor any Agents have, during the five years before the date this EDS is signed, or, with respect to a Contractor, an Affiliated Entity, or an Affiliated Entity of a Contractor during the five years before the date of such Contractor's or Affiliated Entity's contract or engagement in connection with the Matter:

- a. bribed or attempted to bribe, or been convicted or adjudged guilty of bribery or attempting to bribe, a public officer or employee of the City, the State of Illinois, or any agency of the federal government or of any state or local government in the United States of America, in that officer's or employee's official capacity;
- b. agreed or colluded with other bidders or prospective bidders, or been a party to any such agreement, or been convicted or adjudged guilty of agreement or collusion among bidders or prospective bidders, in restraint of freedom of competition by agreement to bid a fixed price or otherwise; or
- c. made an admission of such conduct described in a. or b. above that is a matter of record, but have not been prosecuted for such conduct; or
- d. violated the provisions of Municipal Code Section 2-92-610 (Living Wage Ordinance).

4. Neither the Disclosing Party, Affiliated Entity or Contractor, or any of their employees, officials, agents or partners, is barred from contracting with any unit of state or local government as a result of engaging in or being convicted of (1) bid-rigging in violation of 720 ILCS 5/33E-3; (2) bid-rotating in violation of 720 ILCS 5/33E-4; or (3) any similar offense of any state or of the United States of America that contains the same elements as the offense of bid-rigging or bid-rotating.

5. Neither the Disclosing Party nor any Affiliated Entity is listed on any of the following lists maintained by the Office of Foreign Assets Control of the U.S. Department of the Treasury or the Bureau of Industry and Security of the U.S. Department of Commerce or their successors: the Specially Designated Nationals List, the Denied Persons List, the Unverified List, the Entity List and the Debarred List.

6. The Disclosing Party understands and shall comply with (1) the applicable requirements of Chapters 2-55 (Legislative Inspector General), 2-56 (Inspector General) and 2-156 (Governmental Ethics) of the Municipal Code.

7. If the Disclosing Party is unable to certify to any of the above statements in this Part B (Further Certifications), the Disclosing Party must explain below:

N/A

If the letters "NA," the word "None," or no response appears on the lines above, it will be conclusively presumed that the Disclosing Party certified to the above statements.

C. CERTIFICATION OF STATUS AS FINANCIAL INSTITUTION

1. The Disclosing Party certifies that the Disclosing Party (check one)

is is not

a "financial institution" as defined in Section 2-32-455(b) of the Municipal Code.

2. If the Disclosing Party IS a financial institution, then the Disclosing Party pledges:

"We are not and will not become a predatory lender as defined in Chapter 2-32 of the Municipal Code. We further pledge that none of our affiliates is, and none of them will become, a predatory lender as defined in Chapter 2-32 of the Municipal Code. We understand that becoming a predatory lender or becoming an affiliate of a predatory lender may result in the loss of the privilege of doing business with the City."

If the Disclosing Party is unable to make this pledge because it or any of its affiliates (as defined in Section 2-32-455(b) of the Municipal Code) is a predatory lender within the meaning of Chapter 2-32 of the Municipal Code, explain here (attach additional pages if necessary):

N/A

If the letters "NA," the word "None," or no response appears on the lines above, it will be conclusively presumed that the Disclosing Party certified to the above statements.

D. CERTIFICATION REGARDING INTEREST IN CITY BUSINESS

Any words or terms that are defined in Chapter 2-156 of the Municipal Code have the same meanings when used in this Part D.

1. In accordance with Section 2-156-110 of the Municipal Code: Does any official or employee of the City have a financial interest in his or her own name or in the name of any other person or entity in the Matter?

Yes No

NOTE: If you checked "Yes" to Item D.1., proceed to Items D.2. and D.3. If you checked "No" to Item D.1., proceed to Part E.

2. Unless sold pursuant to a process of competitive bidding, or otherwise permitted, no City elected official or employee shall have a financial interest in his or her own name or in the name of any other person or entity in the purchase of any property that (i) belongs to the City, or (ii) is sold for taxes or assessments, or (iii) is sold by virtue of legal process at the suit of the City (collectively, "City Property Sale"). Compensation for property taken pursuant to the City's eminent domain power does not constitute a financial interest within the meaning of this Part D.

Does the Matter involve a City Property Sale?

Yes No

3. If you checked "Yes" to Item D.1., provide the names and business addresses of the City officials or employees having such interest and identify the nature of such interest:

Name	Business Address	Nature of Interest

4. The Disclosing Party further certifies that no prohibited financial interest in the Matter will be acquired by any City official or employee.

E. CERTIFICATION REGARDING SLAVERY ERA BUSINESS

Please check either 1. or 2. below. If the Disclosing Party checks 2., the Disclosing Party must disclose below or in an attachment to this EDS all information required by paragraph 2. Failure to comply with these disclosure requirements may make any contract entered into with the City in connection with the Matter voidable by the City

X 1. The Disclosing Party verifies that the Disclosing Party has searched any and all records of the Disclosing Party and any and all predecessor entities regarding records of investments or profits from slavery, or slaveholder insurance policies during the slavery era (including insurance policies issued to slaveholders that provided coverage for damage to or injury or death of their slaves), and the Disclosing Party has found no such records.

 2. The Disclosing Party verifies that, as a result of conducting the search in step 1 above, the Disclosing Party has found records of investments or profits from slavery or slaveholder insurance policies. The Disclosing Party verifies that the following constitutes full disclosure of all such records, including the names of any and all slaves or slaveholders described in those records:

SECTION VI - - CERTIFICATIONS FOR FEDERALLY FUNDED MATTERS

NOTE: If the Matter is federally funded, complete this Section VI. If the Matter is not federally funded, proceed to Section VII. For purposes of this Section VI, tax credits allocated by the City and proceeds of debt obligations of the City are not federal funding.

A. CERTIFICATION REGARDING LOBBYING

1. List below the names of all persons or entities registered under the federal Lobbying Disclosure Act of 1995 who have made lobbying contacts on behalf of the Disclosing Party with respect to the Matter: (Add sheets if necessary):

(If no explanation appears or begins on the lines above, or if the letters "NA" or if the word "None" appear, it will be conclusively presumed that the Disclosing Party means that NO persons or entities registered under the Lobbying Disclosure Act of 1995 have made lobbying contacts on behalf of the Disclosing Party with respect to the Matter.)

2. The Disclosing Party has not spent and will not expend any federally appropriated funds to pay any person or entity listed in Paragraph A.1. above for his or her lobbying activities or to pay any person or entity to influence or attempt to influence an officer or employee of any agency, as defined by applicable federal law, a member of Congress, an officer or employee of Congress, or an employee of a member of Congress, in connection with the award of any federally funded contract, making any federally funded grant or loan, entering into any cooperative agreement, or to extend, continue, renew, amend, or modify any federally funded contract, grant, loan, or cooperative agreement.

3. The Disclosing Party will submit an updated certification at the end of each calendar quarter in which there occurs any event that materially affects the accuracy of the statements and information set forth in paragraphs A.1. and A.2. above.

4. The Disclosing Party certifies that either: (i) it is not an organization described in section 501(c)(4) of the Internal Revenue Code of 1986; or (ii) it is an organization described in section 501(c)(4) of the Internal Revenue Code of 1986 but has not engaged and will not engage in "Lobbying Activities".

5. If the Disclosing Party is the Applicant, the Disclosing Party must obtain certifications equal in form and substance to paragraphs A.1. through A.4. above from all subcontractors before it awards any subcontract and the Disclosing Party must maintain all such subcontractors' certifications for the duration of the Matter and must make such certifications promptly available to the City upon request.

B. CERTIFICATION REGARDING EQUAL EMPLOYMENT OPPORTUNITY

If the Matter is federally funded, federal regulations require the Applicant and all proposed subcontractors to submit the following information with their bids or in writing at the outset of negotiations.

Is the Disclosing Party the Applicant?

Yes No

If "Yes," answer the three questions below:

1. Have you developed and do you have on file affirmative action programs pursuant to applicable federal regulations? (See 41 CFR Part 60-2.)

Yes No

2. Have you filed with the Joint Reporting Committee, the Director of the Office of Federal Contract Compliance Programs, or the Equal Employment Opportunity Commission all reports due under the applicable filing requirements?

Yes No

3. Have you participated in any previous contracts or subcontracts subject to the equal opportunity clause?

Yes No

If you checked "No" to question 1. or 2. above, please provide an explanation:

SECTION VII - - ACKNOWLEDGMENTS, CONTRACT INCORPORATION, COMPLIANCE, PENALTIES, DISCLOSURE

The Disclosing Party understands and agrees that:

A. The certifications, disclosures, and acknowledgments contained in this EDS will become part of any Contract or other agreement between the Applicant and the City in connection with the Matte, whether Procurement, City assistance, or other City action, and are material inducements to the City's execution of any contract or taking other action with respect to the Matter. The Disclosing Party understands that it must comply with all statutes, ordinances, and regulations on which this EDS is based.

B. The City's Governmental Ethics and Campaign Financing Ordinances, Chapters 2-156 and 2-164 of the Municipal Code, impose certain duties and obligations on persons or entities seeking City contracts, work, business, or transactions. The full text of these ordinances and a training program is available on line at www.cityofchicago.org/Ethics, and may also be obtained from the City's Board of Ethics, 740 N.

Sedgwick St., Suite 500, Chicago, IL 60610, (312) 744-9660. The Disclosing Party must comply fully with the applicable ordinances.

C. If the City determines that any information provided in this EDS is false, incomplete or inaccurate, any contract or other agreement in connection with which it is submitted may be rescinded or be void or voidable, and the City may pursue any remedies under the contract or agreement (if not rescinded or void), at law, or in equity, including terminating the Disclosing Party's participation in the Matter and/or declining to allow the Disclosing Party to participate in other transactions with the City. Remedies at law for a false statement of material fact may include incarceration and an award to the City of treble damages.

D. It is the City's policy to make this document available to the public on its Internet site and/or upon request. Some or all of the information provided on this EDS and any attachments to this EDS may be made available to the public on the Internet, in response to a Freedom of Information Act request, or otherwise. By completing and signing this EDS, the Disclosing Party waives and releases any possible rights or claims which it may have against the City in connection with the public release of information contained in this EDS and also authorizes the City to verify the accuracy of any information submitted in this EDS.

E. The information provided in this EDS must be kept current. In the event of changes, the Disclosing Party must supplement this EDS up to the time the City takes action on the Matter. If the Matter is a contract being handled by the City's Department of Procurement Services, the Disclosing Party must update this EDS as the contract requires. **NOTE:** With respect to Matters subject to Article I of Chapter 1-23 of the Municipal Code (imposing **PERMANENT INELIGIBILITY** for certain specified Offenses), the information provided herein regarding eligibility must be kept current for a longer period, As required by Chapter 1-23 and Section 2-154-020 of the Municipal Code.

The Disclosing Party represents and warrants that:

F.1. The Disclosing Party is not delinquent in the payment of any tax administered by the Illinois Department of Revenue, nor are the Disclosing Party or its Affiliated Entities delinquent in paying any fine, fee, tax or other charge owed to the City. This includes, but is not limited to, all water charges, sewer charges, license fees, parking tickets, property taxes or sales taxes.

F.2. If the Disclosing Party is the Applicant, the Disclosing Party and its Affiliated Entities will not use, nor permit their subcontractors to use, any facility listed by the U.S. E.P.A. on the federal Excluded Parties List System ("EPLS") maintained by the U.S. General Services Administration.

F.3. If the Disclosing Party is the Applicant, the Disclosing Party will obtain from any contractors/subcontractors hired or to be hired in connection with the Matter certifications equal in form and substance to those in F.1. and F.2. above and will not, without the prior written consent of the City, use any such contractor/subcontractor that does not provide such certifications or that the Disclosing Party has reason to believe has not provided or cannot provide truthful certifications.

NOTE: If the Disclosing Party cannot certify as to any of the items in F.1., F.2. or F.3. above, an explanatory statement must be attached to this EDS.

CERTIFICATION

Under penalty of perjury, the person signing below: (1) warrants that he/she is authorized to execute this EDS and Appendix A (if applicable) on behalf of the Disclosing Party; and (2) warrants that all certifications and statements contained in this EDS and Appendix A (if applicable) are true, accurate and complete as of the date furnished to the City.

Blue Kangaroo, LLC

(Print or type name of Disclosing Party)

By: X *Gordon S. Hughes*
(Sign here)

GORDON S. HUGHES
(Print or type name of person signing)

Managing member

(Print or type title of person signing)

Signed and sworn to before me on (date) August 25, 2011

at DuPage County, ILLINOIS (state).

Tammy Ann Stern Notary Public.

Commission expires: 7/21/2015

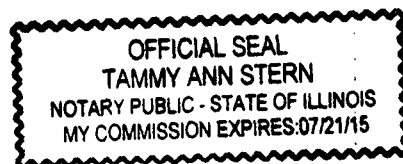

**CITY OF CHICAGO
ECONOMIC DISCLOSURE STATEMENT AND AFFIDAVIT
APPENDIX A**

FAMILIAL RELATIONSHIPS WITH ELECTED CITY OFFICIALS AND DEPARTMENT HEADS

This Appendix is to be completed only by (a) the Applicant, and (b) any legal entity which has a direct ownership interest in the Applicant exceeding 7.5 percent. It is not to be completed by any legal entity which has only an indirect ownership interest in the Applicant.

Under Municipal Code Section 2-154-015, the Disclosing Party must disclose whether such Disclosing Party or any "Applicable Party" or any Spouse or Domestic Partner thereof currently has a "familial relationship" with any elected city official or department head. A "familial relationship" exists if, as of the date this EDS is signed, the Disclosing Party or any "Applicable Party" or any Spouse or Domestic Partner thereof is related to the mayor, any alderman, the city clerk, the city treasurer or any city department head as spouse or domestic partner or as any of the following, whether by blood or adoption: parent, child, brother or sister, aunt or uncle, niece or nephew, grandparent, grandchild, father-in-law, mother-in-law, son-in-law, daughter-in-law, stepfather or stepmother, stepson or stepdaughter, stepbrother or stepsister or half-brother or half-sister.

"Applicable Party" means (1) all executive officers of the Disclosing Party listed in Section II.B.1.a., if the Disclosing Party is a corporation; all partners of the Disclosing Party, if the Disclosing Party is a general partnership; all general partners and limited partners of the Disclosing Party, if the Disclosing Party is a limited partnership; all managers, managing members and members of the Disclosing Party, if the Disclosing Party is a limited liability company; (2) all principal officers of the Disclosing Party; and (3) any person having more than a 7.5 percent ownership interest in the Disclosing Party. "Principal officers" means the president, chief operating officer, executive director, chief financial officer, treasurer or secretary of a legal entity or any person exercising similar authority.

Does the Disclosing Party or any "Applicable Party" or any Spouse or Domestic Partner thereof currently have a "familial relationship" with an elected city official or department head?

Yes

No

If yes, please identify below (1) the name and title of such person, (2) the name of the legal entity to which such person is connected; (3) the name and title of the elected city official or department head to whom such person has a familial relationship, and (4) the precise nature of such familial relationship.

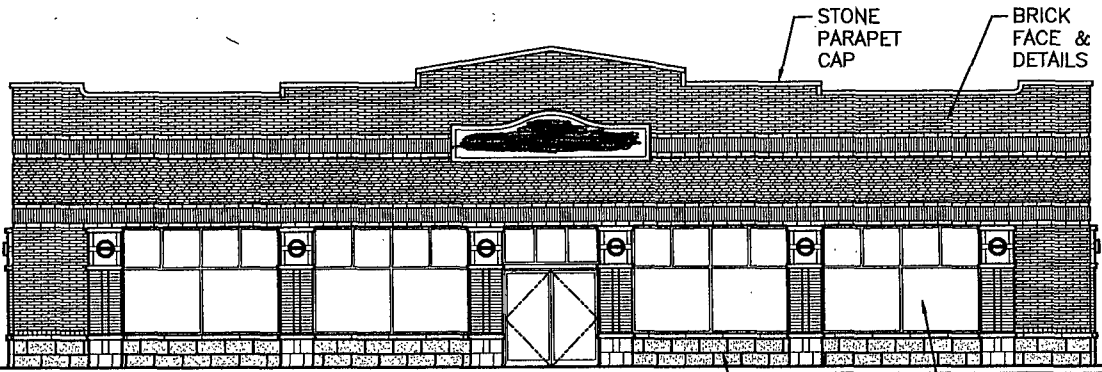

EAST ELEVATION

SCALE: 1/8" = 10'-0"

STONE BASE COURSE ALUM. STOREFRONT

ELEVATION NOTE:
NO EXPOSED CMU/SPLIT
FACE BLOCK

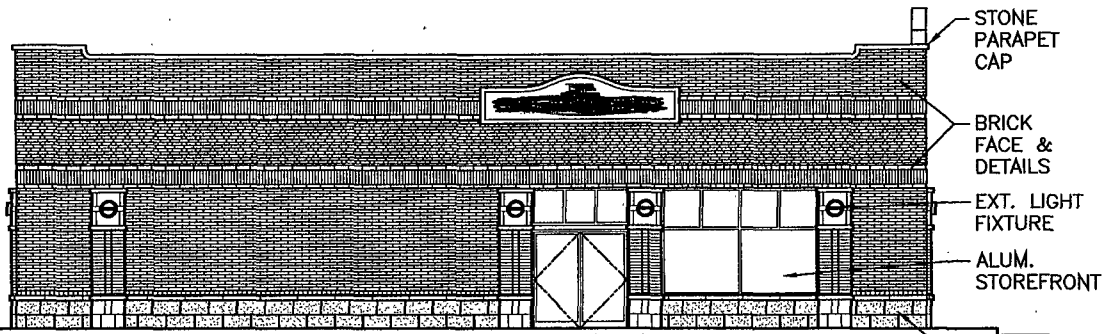

SOUTH ELEVATION

SCALE: 1/8" = 10'-0"

STONE BASE COURSE

COPYRIGHT © 2010 - GEA Architects, LTD.



gea architects ltd

714 ENTERPRISE DRIVE, SUITE 100
OAK BROOK - ILLINOIS - 60523
Voice 630.725.9330 - Fax 630.725.9340

24th & S. Pulaski Rd.

Chicago, IL

DATE	DRAWING	SK
11-18-10	PROPOSED	
	ELEVATIONS	

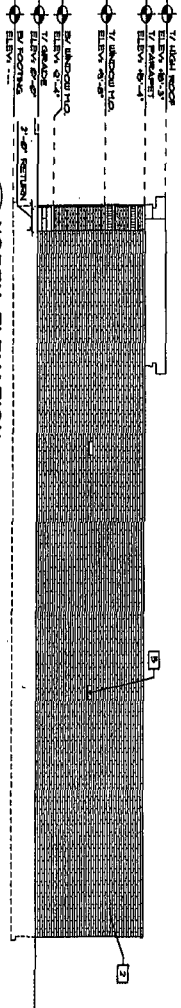

4 NORTH ELEVATION
SCALE 1/8"=1'-0"

MATERIAL TAGS	
1	WOOD CASE WITH BRASS HANDS
2	WOOD COLUMN 3" DIA.
3	STAINLESS STEEL BRUSH, 1/2" SQUARE COLUMN, 1/2" DIA.
4	STONE BRICK
5	GLAZED BRICK
6	LIGHT FINISH
7	INSULATED BRICK
8	SOLID CORE GLASS
9	STONE CORNER
10	METAL, UNPAINTED
11	METAL, 1" THICK
12	METALWORK LOWER
13	TRIM

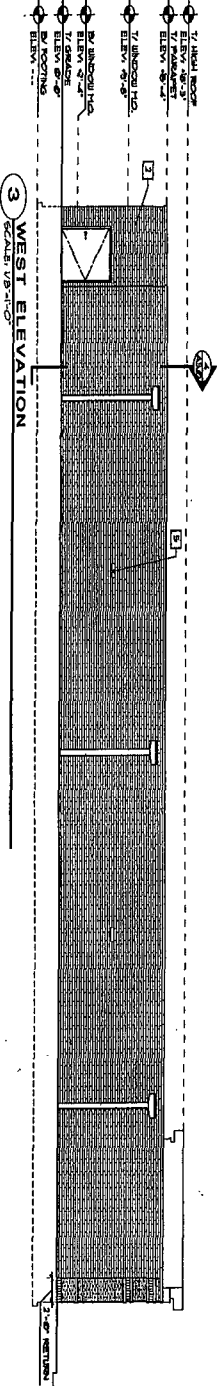

3 WEST ELEVATION
SCALE 1/8"=1'-0"

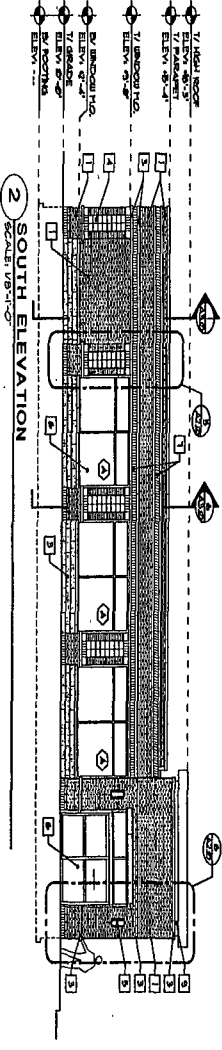

2 SOUTH ELEVATION
SCALE 1/8"=1'-0"

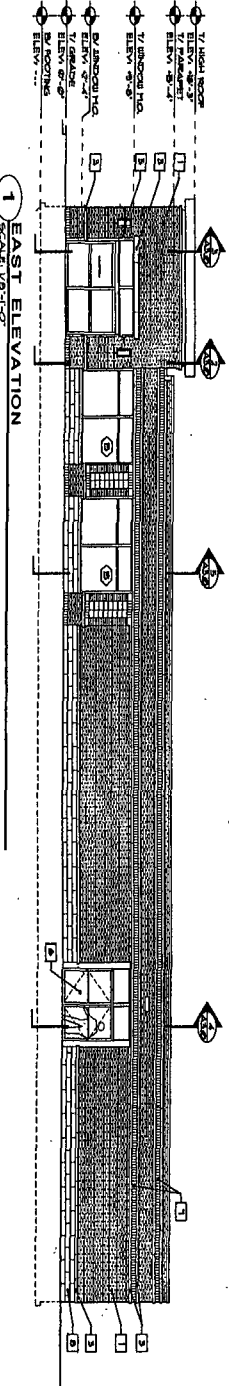

1 EAST ELEVATION
SCALE 1/8"=1'-0"

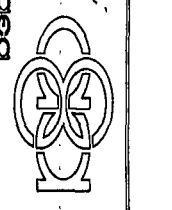

geod architeccta ltd
7th INTERNATIONAL DRIVE
SUITE 100
1000 WOODLARK BLVD # 1000
STANBROOK, ILLINOIS 60188
PHONE: 630-229-1100
FAX: 630-229-1101

CONTRACT NO. 2007 - GEA ARCHITECTURE, LTD.
GEA ARCHITECTURE, LTD. SHALL RETAIN ALL RIGHTS AND SHALL BE RESPONSIBLE FOR THE DESIGN AND CONSTRUCTION OF THE PROJECT. THE CONTRACTOR SHALL BE RESPONSIBLE FOR THE CONSTRUCTION OF THE PROJECT. THE CONTRACTOR SHALL BE RESPONSIBLE FOR THE CONSTRUCTION OF THE PROJECT. THE CONTRACTOR SHALL BE RESPONSIBLE FOR THE CONSTRUCTION OF THE PROJECT.

DATE	DRAWING ISSUE

FOR THE OWNER: GEA ARCHITECTURE, LTD.
FOR THE ARCHITECT: GEA ARCHITECTURE, LTD.
FOR THE CONTRACTOR: [Blank]

BLUE KANGAROO

24TH AND PULASKI
CHICAGO, IL 60623

DATE PREPARED	DATE DRAWN BY
JOB NO.	FILE NO.
A-2.0	

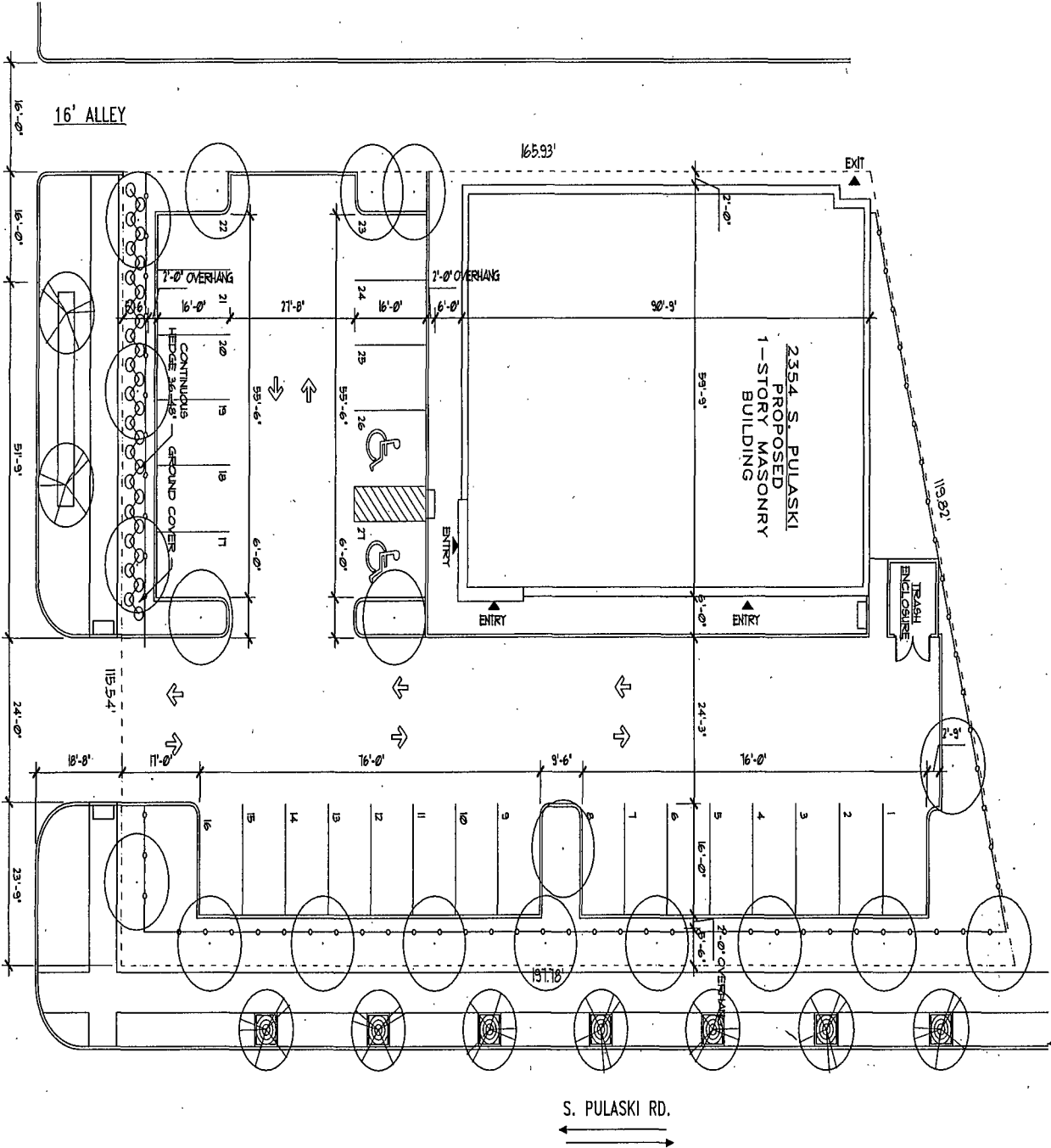

1 SITE PLAN
SCALE: 1/8"=1'-0"

S. PULASKI RD.
→

SHEET NO. A-0.1	BLUE KANGAROO 24TH AND PULASKI CHICAGO, IL 60623		ged architects llc THE ENTERPRISE DRIVE ONE BLOCK - LADOL - 60325 THE 60312/020 F. 60312/020 PROFESSIONAL DESIGN TEAM LICENSE NUMBER: 06-00272	CONTRACTOR: S. B. & S. R. ARCHITECTS, LTD. 60312/020 F. 60312/020 ONE BLOCK - LADOL - 60325 THE 60312/020 F. 60312/020 PROFESSIONAL DESIGN TEAM LICENSE NUMBER: 06-00272
	DATE: 5/11/10	DRAWN BY: M		
JOB NO.: M	FILE NO.: M	DATE: 5/11/10	DRAWN BY: M	JOB NO.: M
DATE: 5/11/10	DRAWN BY: M	DATE: 5/11/10	DRAWN BY: M	DATE: 5/11/10



SCALE:
1" = 20'

R & R Surveyors, LTD.

CONSTRUCTION AND LAND SURVEYORS
P.O. BOX 412 WAUCONDA, IL 60084
TEL: (773) 450-9321 FAX: (773) 504-9321
ACCURATEA@ATT.NET

PLAT OF SURVEY

LOTS 3,4,5,6,7 AND 8 IN EDWARD DRIVER'S RESUBDIVISION OF THE EAST 1/2 OF BLOCKS 1,2,3,4 AND VACATED ALLEY THROUGH SAME IN CRAWFORD'S SUBDIVISION OF THE PART OF THE NORTHEAST 1/4 SECTION 27, TOWNSHIP 39 NORTH, RANGE 13 EAST OF THE THIRD PRINCIPAL MERIDIAN, LYING SOUTH OF CHICAGO, BURLINGTON AND QUINCY RAILROAD, IN COOK COUNTY, ILLINOIS.

COMMONLY KNOWN AS: 2350-2360 SOUTH PULASKI ROAD, CHICAGO ILLINOIS.

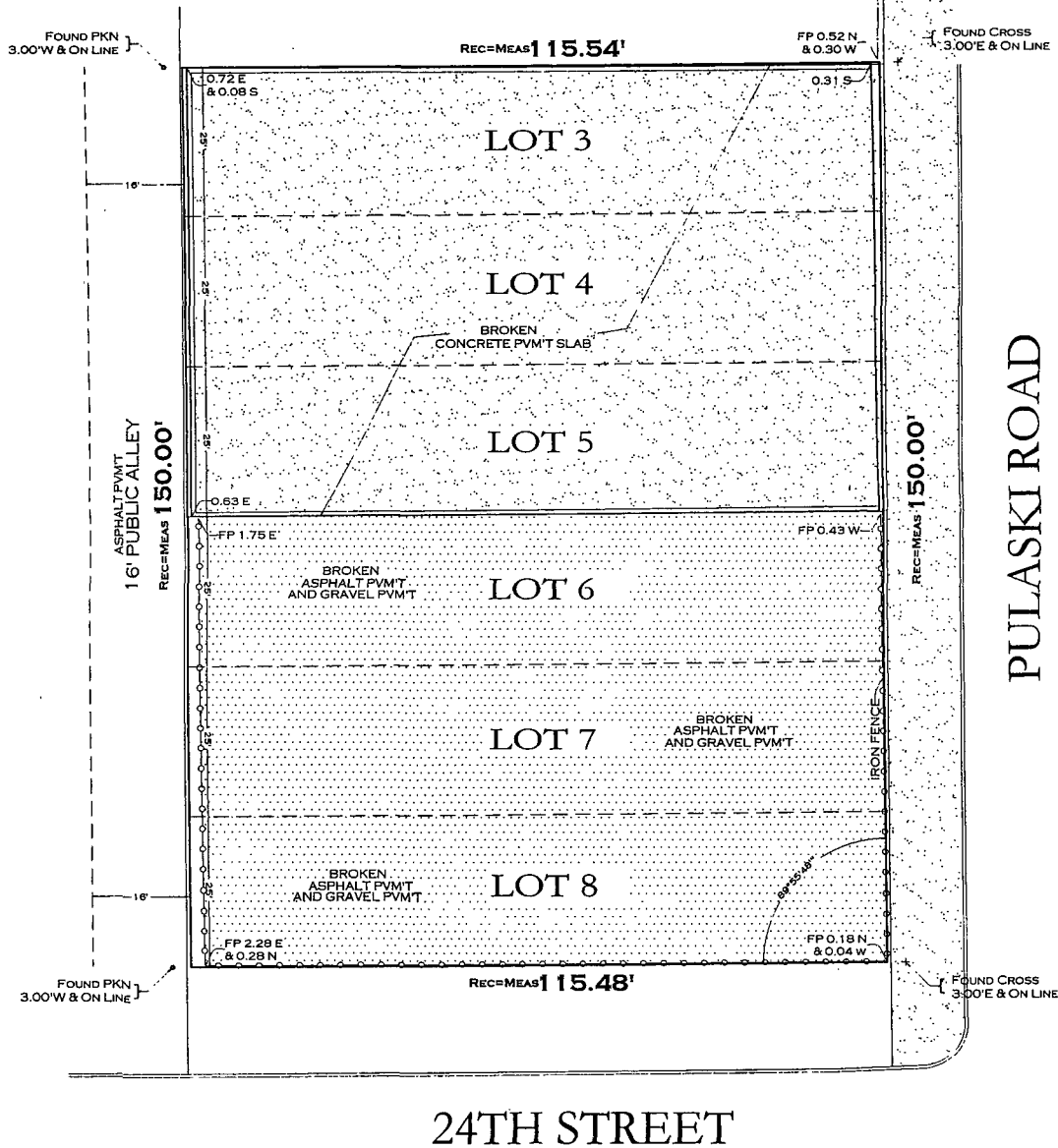

24TH STREET

NOTE:
 -DIMENSIONS ARE SHOWN IN FEET AND DECIMALS AND ARE CORRECTED TO A TEMPERATURE OF 68 DEGREES FAHRENHEIT.
 -THE LEGAL DESCRIPTION SHOWN ON THE PLAT HEREON DRAWN IS A COPY OF THE ORDER & FOR ACCURACY SHOULD BE COMPARED WITH THE TITLE OR DEED.
 -DIMENSIONS ARE NOT TO BE ASSUMED FOR SCALING
 -COMPARE ALL POINTS BEFORE BUILDING BY SAME AND AT ONCE REPORT ANY DIFFERENCES.
 -REFER TO DEED, TITLE POLICY, AND LOCAL ORDINANCES FOR BUILDING RESTRICTIONS
 -COMPARE ALL POINTS BEFORE BUILDING BY SAME AND AT ONCE REPORT ANY DIFFERENCES.

ORDER# 10-4191
 DATE: 09/05/2010
 ORDERED BY: ANAS A

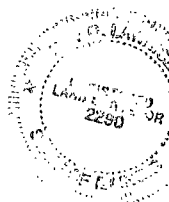

STATE OF ILLINOIS
 COUNTY OF MCHENRY
 ROY G. LAWNCZAK
 DO HEREBY CERTIFY THAT THE ABOVE DESCRIBED PROPERTY HAS BEEN SURVEYED UNDER MY SUPERVISION IN THE MANNER REPRESENTED ON THE PLAT HEREON DRAWN. THIS PROFESSIONAL SERVICE CONFORMS TO THE CURRENT ILLINOIS MINIMUM STANDARDS FOR A BOUNDARY SURVEY.
 CARY, ILLINOIS
 SEPTEMBER 13/2010
 BY: Roy G. Lawnczak
 ROY G. LAWNCZAK, ILL. REG. LAND SURVEYOR #2250



SCALE:
1" = 20'

R & R Surveyors, L.P.O.

CONSTRUCTION AND LAND SURVEYORS
P.O. BOX 412 WAUCONDA, IL 60084
TEL: (847) 526-1793 FAX: (847) 526-1794

PLAT OF SURVEY

LOTS 1 AND 2 (EXCEPT THAT PART LYING NORTH OF A LINE DRAWN PARALLEL WITH AND 25.00 FEET SOUTHERLY FROM, MEASURED AT RIGHT ANGLES TO THE NORTH LINE OF LOT 1)
IN EDWARD DRIVER'S RESUBDIVISION OF THE EAST 1/2 OF BLOCKS 1,2,3,4 AND VACATED ALLEY THROUGH SAME IN CRAWFORD'S SUBDIVISION OF THE PART OF THE NORTHEAST 1/4 SECTION 27, TOWNSHIP 39 NORTH, RANGE 13 EAST OF THE THIRD PRINCIPAL MERIDIAN, LYING SOUTH OF CHICAGO, BURLINGTON AND QUINCY RAILROAD, IN COOK COUNTY, ILLINOIS.

COMMONLY KNOWN AS: 2342-2344 SOUTH PULASKI ROAD, CHICAGO ILLINOIS.

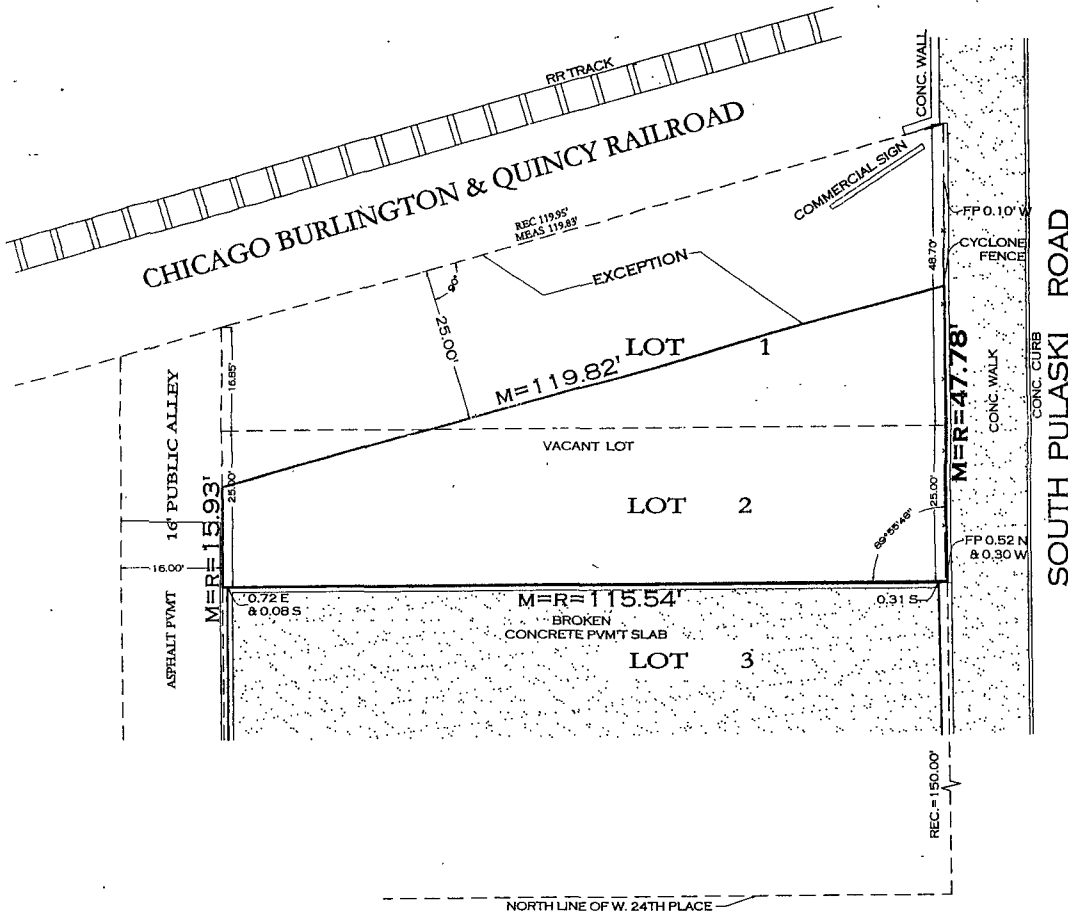

JULY 29, 2011 - REVISED LEGAL DESCRIPTION

NOTE:
 -DIMENSIONS ARE SHOWN IN FEET AND DECIMALS AND ARE CORRECTED TO A TEMPERATURE OF 68 DEGREES FAHRENHEIT.
 -THE LEGAL DESCRIPTION SHOWN ON THE PLAT HEREON DRAWN IS A COPY OF THE ORDER A FOR ACCURACY SHOULD BE COMPARED WITH THE TITLE OR DEED
 -DIMENSIONS ARE NOT TO BE ASSUMED FOR SCALING
 -COMPARE ALL POINTS BEFORE BUILDING BY SAME AND AT ONCE REPORT ANY DIFFERENCES.
 -REFER TO DEED, TITLE POLICY, AND LOCAL ORDINANCES FOR BUILDING RESTRICTIONS
 -COMPARE ALL POINTS BEFORE BUILDING BY SAME AND AT ONCE REPORT ANY DIFFERENCES.

ORDER# 11-4191-2
 DATE: 07/26/2011
 ORDERED BY: ANAS ALKHATIB



STATE OF ILLINOIS)
 COUNTY OF MCHENRY)
 I, ROY G. LAWNICZAK,
 DO HEREBY CERTIFY THAT THE ABOVE DESCRIBED PROPERTY HAS BEEN
 SURVEYED UNDER MY SUPERVISION IN THE MANNER REPRESENTED ON
 THE PLAT HEREON DRAWN. THIS PROFESSIONAL SERVICE CONFORMS TO THE
 CURRENT ILLINOIS MINIMUM STANDARDS FOR A BOUNDARY SURVEY

CARY, ILLINOIS JULY 26, 2011
 BY: Roy G. Lawniczak
 ROY G. LAWNICZAK, ILL. REG. LAND SURVEYOR NO. 2290