



City of Chicago



O2013-7554

Office of the City Clerk

Document Tracking Sheet

Meeting Date:	10/16/2013
Sponsor(s):	City Clerk (transmitted by)
Type:	Ordinance
Title:	Zoning Reclassification App No. 17856 at 1150-1168 N Halsted St
Committee(s) Assignment:	Committee on Zoning, Landmarks and Building Standards

BE IT ORDAINED BY THE CITY COUNCIL OF THE CITY OF CHICAGO:

SECTION 1. That the Chicago Zoning Ordinance be amended by changing all the M3-3 Heavy Industry District symbols and indications as shown on Map No. 3-G in the area bounded by: ..

West Division Street; North Halsted Street; a southwesterly line 87.35 feet long beginning at a point 222.76 feet south of the south line of West Division Street (as measured along the west boundary line of North Halsted Street) and ending at a point 55.5 feet west of the west line of North Halsted Street and 290.16 feet south of the south line of West Division Street; a northwesterly line 10.33 feet long beginning at a point 55.5 feet west of the west line of North Halsted Street and 290.16 feet south of the south line of West Division Street and ending at a point 63.5 feet west of the west line of North Halsted Street and 284.4 feet south of the south line of West Division Street; a southwesterly line 19.15 feet long starting at a point 63.5 feet west of the west line of North Halsted Street and 284.4 feet south of the south line of West Division Street and ending at a point 75.7 feet west of the west line of North Halsted Street and 299.3 feet south of the south line of West Division Street; the northeast boundary line of the Chicago River North Branch Canal, to the point of beginning,

to those of C3-3 Commercial, Manufacturing and Employment District, and a corresponding use district is hereby established in the area above described.

SECTION 2. That the Chicago Zoning Ordinance be amended by changing all the C3-3 Commercial, Manufacturing and Employment District symbols to a Business Planned Development, and a corresponding use district is hereby established in the area above described.

SECTION 3. This ordinance shall be in force and effect from and after its passage and due publication.

#17856
INTRO DATE:
OCT. 16, 2013

CITY OF CHICAGO

APPLICATION FOR AN AMENDMENT TO
THE CHICAGO ZONING ORDINANCE

1. ADDRESS of the property Applicant is seeking to rezone:
1150-1168 North Halsted Street

2. Ward Number that property is located in: 27 - Alderman Walter Burnett

3. APPLICANT Chicago IL (1150 Halsted) LLC
ADDRESS 1400 16th Street, Suite 300 CITY Oak Brook
STATE IL ZIP CODE 60523 PHONE 630-617-9100
EMAIL rrash@insiterealestate.com CONTACT PERSON Robin Rash

4. Is the applicant the owner of the property? YES _____ NO X
If the applicant is not the owner of the property, please provide the following information regarding the owner and attach written authorization from the owner allowing the application to proceed.
OWNER Albany Bank & Trust Co. NA, as T/U/T No. 11-4484, dated 10/21/87
ADDRESS 3400 W. Lawrence Ave. CITY Chicago
STATE IL ZIP CODE 60625 PHONE 773-267-7300
EMAIL _____ CONTACT PERSON Brenda Helms

5. If the Applicant/Owner of the property has obtained a lawyer as their representative for the rezoning, please provide the following information:
ATTORNEY Katriina S. McGuire/Schain, Burney, Banks & Kenny, Ltd.
ADDRESS 70 West Madison Street - Suite 4500
CITY Chicago STATE IL ZIP CODE 60602
PHONE 312-345-5737 FAX 312-345-5701 EMAIL kmcguire@sbbklaw.com

1. 1000
2. 1000
3. 1000

6. If the applicant is a legal entity (Corporation, LLC, Partnership, etc.) please provide the names of all owners as disclosed on the Economic Disclosure Statements.

Chicago IL (1150 Halsted) LLC

Toledo Holdings LLC

ICM Partners LLC

InSite Capital, L.L.C.

Gerald J. Kostelny

Carolyn C. Kostelny

7. On what date did the owner acquire legal title to the subject property? _____

8. Has the present owner previously rezoned this property? If yes, when?

No

9. Present Zoning District M3-3 Proposed Zoning District C3-3 to Business Planned Development

10. Lot size in square feet (or dimensions) 47,300 sq.ft.

11. Current Use of the property Automobile towing facility

12. Reason for rezoning the property To permit the redevelopment of the property for retail, parking and accessory uses.

13. Describe the proposed use of the property after the rezoning. Indicate the number of dwelling units; number of parking spaces; approximate square footage of any commercial space; and height of the proposed building. (BE SPECIFIC)

The site will be developed with an approximately 20,000 sq.ft., one-story retail building and 28 parking spaces.

14. On May 14th, 2007, the Chicago City Council passed the Affordable Requirements Ordinance (ARO) that requires on-site affordable housing units or a financial contribution if residential housing projects receive a zoning change under certain circumstances. Based on the lot size of the project in question and the proposed zoning classification, is this project subject to the Affordable Requirements Ordinance? (See Fact Sheet for more information)

YES _____ NO X

COUNTY OF DUPAGE
STATE OF ILLINOIS

Robin Rash, being first duly sworn on oath, states that all of the above statements and the statements contained in the documents submitted herewith are true and correct.

Robin Rash

Signature of Applicant

Subscribed and Sworn to before me this
1st day of October, 2013.

Virginia M. Lunsford
Notary Public

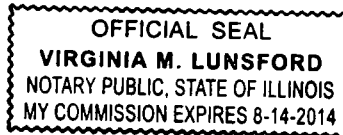

For Office Use Only

Date of Introduction: _____

File Number: _____

Ward: _____

October 9, 2013

Honorable Daniel S. Solis
Chairman, Committee on Zoning
121 North LaSalle Street
Room 304
Chicago, Illinois 60602

Committee Members:

The undersigned, Katriina S. McGuire, being first duly sworn on oath, deposes and says the following:

That the undersigned certifies that she has complied with the requirements of Section 17-13-0107-A of the Chicago Zoning Ordinance by sending the attached letter by United States Postal Service first class mail on such property owners who appear to be the owners of said property within the subject area not solely owned by the applicant, and on the owners of all property within 250 feet in each direction of the lot line of the subject property, exclusive of public roads, streets, alleys and other public ways, or a total distance limited to 400 feet, and that the notice contained the address of the property sought to be rezoned; a statement of intended use of said property; the name and address of the applicant; a statement that the applicant intends to file an application for a change in zoning on approximately October 9, 2013; that the applicant has made a bonafide effort to determine the addresses of the parties to be notified under Section 17-13-0107-A of the Chicago Zoning Ordinance; that the applicant certifies that the accompanying list of names and addresses of surrounding property owners within 250 feet, recognizing the above limits, is a complete list containing the names and last known addresses of the owners of the property required to be served and that the applicant has furnished in addition a list of the persons so served.

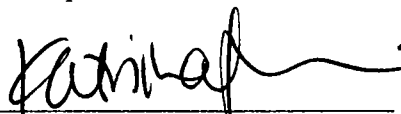
Katriina S. McGuire
Attorney for Applicant

Subscribed and Sworn to before me
this 8th day of October, 2013

Notary Public

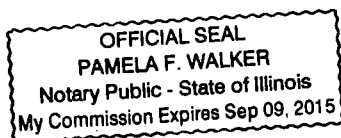

October 9, 2013

Dear Sir/Madam:

In accordance with the Amendment to the Zoning Code enacted by the City Council, Section 17-13-0107-A of the Chicago Zoning Ordinance please be advised that on or about October 9, 2013, I, the undersigned, will file an application for a zoning amendment for the property located at 1150-1168 North Halsted Street, Chicago, Illinois. The application seeks to rezone the property from M3-3 Heavy Industry District to C3-3 Commercial, Manufacturing and Employment District and then to a Business Planned Development.

The applicant for the zoning amendment is Chicago IL (1150 Halsted) LLC, located at 1400 16th Street, Suite 300, Oak Brook, Illinois 60523. The owner of the property is Albany Bank & Trust Co. NA, as T/U/T No. 11-4484, dated 10/21/87, located at 3400 West Lawrence Avenue, Chicago, Illinois 60625.

The applicant proposes to redevelop the property with an approximately 20,000 square foot, single-story retail store with 28 parking spaces.

I am the duly authorized attorney for the applicant. My address is 70 West Madison, Suite 4500, Chicago, Illinois 60602. My telephone number is (312) 345-5700.

PLEASE NOTE THAT THE APPLICANT IS NOT SEEKING TO PURCHASE OR REZONE YOUR PROPERTY. THE APPLICANT IS REQUIRED BY LAW TO SEND YOU THIS NOTICE BECAUSE YOU OWN PROPERTY LOCATED WITHIN 250 FEET OF THE SUBJECT PROPERTY.

Very truly yours,

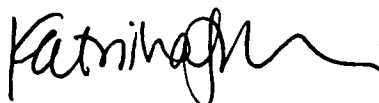

Katriina S. McGuire
Attorney for Applicant

CHICAGO IL (1150 HALSTED) LLC ORGANIZATIONAL CHART

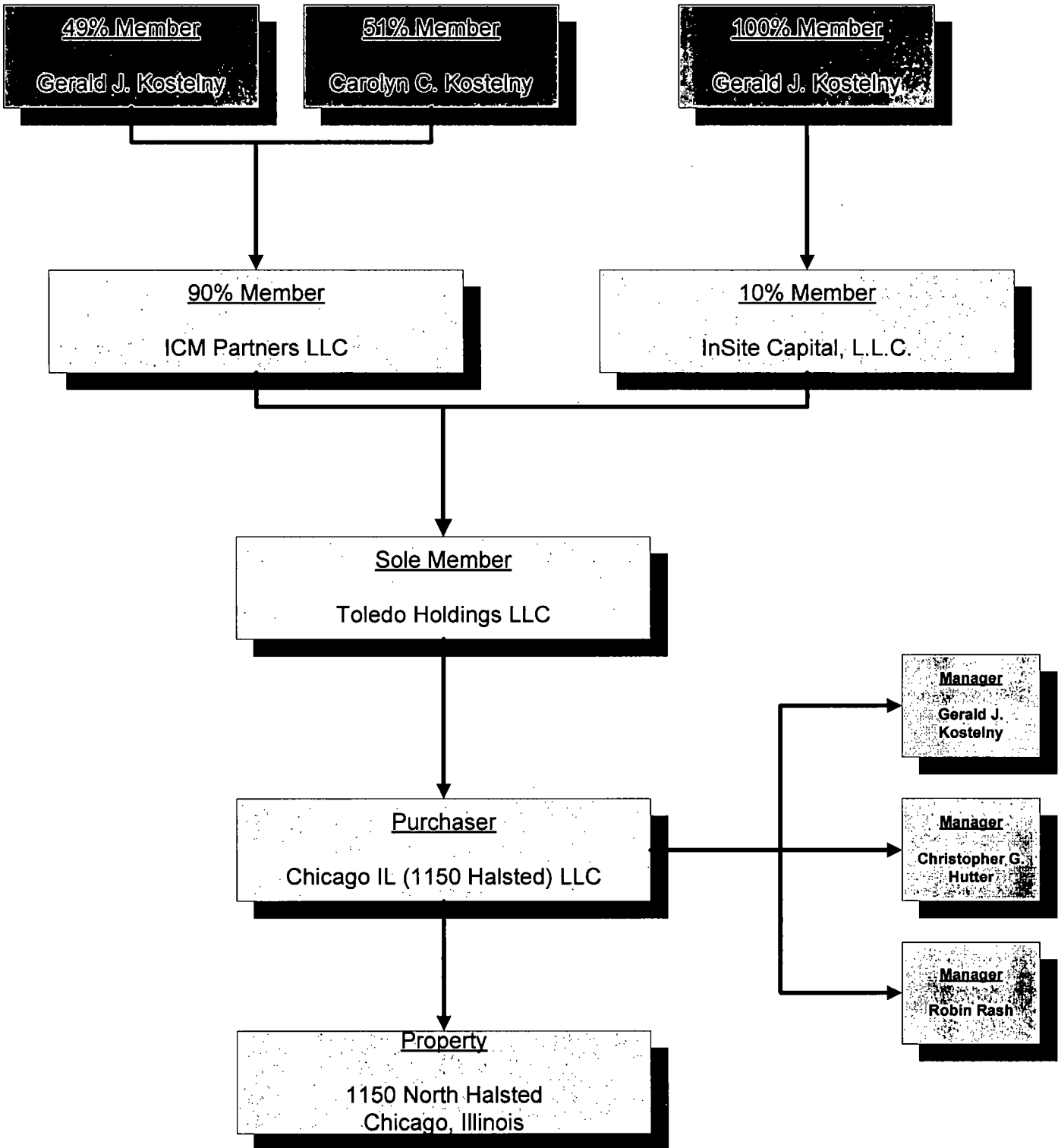

**CITY OF CHICAGO
ECONOMIC DISCLOSURE STATEMENT
AND AFFIDAVIT**

SECTION I – GENERAL INFORMATION

A. Legal name of the Disclosing Party submitting this EDS. Include d/b/a/ if applicable:

Chicago IL (1150 Halsted) LLC, an Illinois limited liability company

Check ONE of the following three boxes:

Indicate whether the Disclosing Party submitting this EDS is:

1. the Applicant

OR

2. a legal entity holding a direct or indirect interest in the Applicant. State the legal name of the Applicant in which the Disclosing Party holds an interest: _____

OR

3. a legal entity with a right of control (see Section II.B.1.) State the legal name of the entity in which the Disclosing Party holds a right of control: _____

B. Business address of the Disclosing Party: c/o InSite Real Estate, L.L.C.

1400 16th Street, Suite 300

Oak Brook, Illinois 60523

C. Telephone: 630/617-9100 Fax: 630/617-9120 Email: rrash@insiterealestate.com

D. Name of contact person: Robin Rash

E. Federal Employer Identification No. (if you have one): _____

F. Brief description of contract, transaction or other undertaking (referred to below as the "Matter") to which this EDS pertains. (Include project number and location of property, if applicable):

PD application for property at 1150-1168 North Halsted, Chicago, Illinois

G. Which City agency or department is requesting this EDS? DHED, Law Dept.

If the Matter is a contract being handled by the City's Department of Procurement Services, please complete the following:

Specification # _____ and Contract # _____

SECTION II -- DISCLOSURE OF OWNERSHIP INTERESTS

A. NATURE OF THE DISCLOSING PARTY

1. Indicate the nature of the Disclosing Party:

- Person
- Publicly registered business corporation
- Privately held business corporation
- Sole proprietorship
- General partnership
- Limited partnership
- Trust
- Limited liability company
- Limited liability partnership
- Joint venture
- Not-for-profit corporation
(Is the not-for-profit corporation also a 501(c)(3))?
 Yes No
- Other (please specify)

2. For legal entities, the state (or foreign country) of incorporation or organization, if applicable:

Illinois

3. For legal entities not organized in the State of Illinois: Has the organization registered to do business in the State of Illinois as a foreign entity?

- Yes No N/A

B. IF THE DISCLOSING PARTY IS A LEGAL ENTITY:

1. List below the full names and titles of all executive officers and all directors of the entity.

NOTE: For not-for-profit corporations, also list below all members, if any, which are legal entities. If there are no such members, write "no members." For trusts, estates or other similar entities, list below the legal titleholder(s).

If the entity is a general partnership, limited partnership, limited liability company, limited liability partnership or joint venture, list below the name and title of each general partner, managing member, manager or any other person or entity that controls the day-to-day management of the Disclosing Party.

NOTE: Each legal entity listed below must submit an EDS on its own behalf.

Name	Title
Gerald J. Kostelny	Manager and Managing Director
Robin Rash	Manager
Christopher G. Hutter	Manager

2. Please provide the following information concerning each person or entity having a direct or indirect beneficial interest (including ownership) in excess of 7.5% of the Disclosing Party. Examples of such an interest include shares in a corporation, partnership interest in a partnership or joint venture,

interest of a member or manager in a limited liability company, or interest of a beneficiary of a trust, estate or other similar entity. If none, state "None." **NOTE:** Pursuant to Section 2-154-030 of the Municipal Code of Chicago ("Municipal Code"), the City may require any such additional information from any applicant which is reasonably intended to achieve full disclosure.

Name	Business Address	Percentage Interest in the Disclosing Party
Toledo Holdings LLC	1400 16th Street, Suite 300 Oak Brook, Illinois 60523	100%

SECTION III -- BUSINESS RELATIONSHIPS WITH CITY ELECTED OFFICIALS

Has the Disclosing Party had a "business relationship," as defined in Chapter 2-156 of the Municipal Code, with any City elected official in the 12 months before the date this EDS is signed?

Yes No

If yes, please identify below the name(s) of such City elected official(s) and describe such relationship(s):

SECTION IV -- DISCLOSURE OF SUBCONTRACTORS AND OTHER RETAINED PARTIES

The Disclosing Party must disclose the name and business address of each subcontractor, attorney, lobbyist, accountant, consultant and any other person or entity whom the Disclosing Party has retained or expects to retain in connection with the Matter, as well as the nature of the relationship, and the total amount of the fees paid or estimated to be paid. The Disclosing Party is not required to disclose employees who are paid solely through the Disclosing Party's regular payroll.

"Lobbyist" means any person or entity who undertakes to influence any legislative or administrative action on behalf of any person or entity other than: (1) a not-for-profit entity, on an unpaid basis, or (2) himself. "Lobbyist" also means any person or entity any part of whose duties as an employee of another includes undertaking to influence any legislative or administrative action.

If the Disclosing Party is uncertain whether a disclosure is required under this Section, the Disclosing Party must either ask the City whether disclosure is required or make the disclosure.

Name (indicate whether retained or anticipated to be retained)	Business Address	Relationship to Disclosing Party (subcontractor, attorney, lobbyist, etc.)	Fees (indicate whether paid or estimated.) NOTE: "hourly rate" or "t.b.d." is not an acceptable response.
Katriina McGuire of Schain, Burney, Banks & Kenny, Ltd.	70 West Madison St. Suite 4500 Chicago, Illinois 60602	Attorney	\$10,000.00 estimated

(Add sheets if necessary)

[] Check here if the Disclosing Party has not retained, nor expects to retain, any such persons or entities.

SECTION V -- CERTIFICATIONS

A. COURT-ORDERED CHILD SUPPORT COMPLIANCE

Under Municipal Code Section 2-92-415, substantial owners of business entities that contract with the City must remain in compliance with their child support obligations throughout the contract's term.

Has any person who directly or indirectly owns 10% or more of the Disclosing Party been declared in arrearage on any child support obligations by any Illinois court of competent jurisdiction?

[] Yes [X] No [] No person directly or indirectly owns 10% or more of the Disclosing Party.

If "Yes," has the person entered into a court-approved agreement for payment of all support owed and is the person in compliance with that agreement?

[] Yes [] No

B. FURTHER CERTIFICATIONS

1. Pursuant to Municipal Code Chapter 1-23, Article I ("Article I")(which the Applicant should consult for defined terms (e.g., "doing business") and legal requirements), if the Disclosing Party submitting this EDS is the Applicant and is doing business with the City, then the Disclosing Party certifies as follows: (i) neither the Applicant nor any controlling person is currently indicted or charged with, or has admitted guilt of, or has ever been convicted of, or placed under supervision for, any criminal offense involving actual, attempted, or conspiracy to commit bribery, theft, fraud, forgery, perjury, dishonesty or deceit against an officer or employee of the City or any sister agency; and (ii) the Applicant understands and acknowledges that compliance with Article I is a continuing requirement for doing business with the City. **NOTE:** If Article I applies to the Applicant, the permanent compliance timeframe in Article I supersedes some five-year compliance timeframes in certifications 2 and 3 below.

2. The Disclosing Party and, if the Disclosing Party is a legal entity, all of those persons or entities identified in Section II.B.1. of this EDS:

- a. are not presently debarred, suspended, proposed for debarment, declared ineligible or voluntarily excluded from any transactions by any federal, state or local unit of government;
- b. have not, within a five-year period preceding the date of this EDS, been convicted of a criminal offense, adjudged guilty, or had a civil judgment rendered against them in connection with: obtaining, attempting to obtain, or performing a public (federal, state or local) transaction or contract under a public transaction; a violation of federal or state antitrust statutes; fraud; embezzlement; theft; forgery; bribery; falsification or destruction of records; making false statements; or receiving stolen property;
- c. are not presently indicted for, or criminally or civilly charged by, a governmental entity (federal, state or local) with committing any of the offenses set forth in clause B.2.b. of this Section V;
- d. have not, within a five-year period preceding the date of this EDS, had one or more public transactions (federal, state or local) terminated for cause or default; and
- e. have not, within a five-year period preceding the date of this EDS, been convicted, adjudged guilty, or found liable in a civil proceeding, or in any criminal or civil action, including actions concerning environmental violations, instituted by the City or by the federal government, any state, or any other unit of local government.

3. The certifications in subparts 3, 4 and 5 concern:

- the Disclosing Party;
- any "Contractor" (meaning any contractor or subcontractor used by the Disclosing Party in connection with the Matter, including but not limited to all persons or legal entities disclosed under Section IV, "Disclosure of Subcontractors and Other Retained Parties");
- any "Affiliated Entity" (meaning a person or entity that, directly or indirectly: controls the Disclosing Party, is controlled by the Disclosing Party, or is, with the Disclosing Party, under common control of another person or entity. Indicia of control include, without limitation: interlocking management or ownership; identity of interests among family members, shared facilities and equipment; common use of employees; or organization of a business entity following the ineligibility of a business entity to do business with federal or state or local government, including the City, using substantially the same management, ownership, or principals as the ineligible entity); with respect to Contractors, the term Affiliated Entity means a person or entity that directly or indirectly controls the Contractor, is controlled by it, or, with the Contractor, is under common control of another person or entity;
- any responsible official of the Disclosing Party, any Contractor or any Affiliated Entity or any other official, agent or employee of the Disclosing Party, any Contractor or any Affiliated Entity, acting pursuant to the direction or authorization of a responsible official of the Disclosing Party, any Contractor or any Affiliated Entity (collectively "Agents").

Neither the Disclosing Party, nor any Contractor, nor any Affiliated Entity of either the Disclosing Party or any Contractor nor any Agents have, during the five years before the date this EDS is signed, or, with respect to a Contractor, an Affiliated Entity, or an Affiliated Entity of a Contractor during the five years before the date of such Contractor's or Affiliated Entity's contract or engagement in connection with the Matter:

- a. bribed or attempted to bribe, or been convicted or adjudged guilty of bribery or attempting to bribe, a public officer or employee of the City, the State of Illinois, or any agency of the federal government or of any state or local government in the United States of America, in that officer's or employee's official capacity;
- b. agreed or colluded with other bidders or prospective bidders, or been a party to any such agreement, or been convicted or adjudged guilty of agreement or collusion among bidders or prospective bidders, in restraint of freedom of competition by agreement to bid a fixed price or otherwise; or
- c. made an admission of such conduct described in a. or b. above that is a matter of record, but have not been prosecuted for such conduct; or
- d. violated the provisions of Municipal Code Section 2-92-610 (Living Wage Ordinance).

4. Neither the Disclosing Party, Affiliated Entity or Contractor, or any of their employees, officials, agents or partners, is barred from contracting with any unit of state or local government as a result of engaging in or being convicted of (1) bid-rigging in violation of 720 ILCS 5/33E-3; (2) bid-rotating in violation of 720 ILCS 5/33E-4; or (3) any similar offense of any state or of the United States of America that contains the same elements as the offense of bid-rigging or bid-rotating.

5. Neither the Disclosing Party nor any Affiliated Entity is listed on any of the following lists maintained by the Office of Foreign Assets Control of the U.S. Department of the Treasury or the Bureau of Industry and Security of the U.S. Department of Commerce or their successors: the Specially Designated Nationals List, the Denied Persons List, the Unverified List, the Entity List and the Debarred List.

6. The Disclosing Party understands and shall comply with the applicable requirements of Chapters 2-55 (Legislative Inspector General), 2-56 (Inspector General) and 2-156 (Governmental Ethics) of the Municipal Code.

7. If the Disclosing Party is unable to certify to any of the above statements in this Part B (Further Certifications), the Disclosing Party must explain below:

If the letters "NA," the word "None," or no response appears on the lines above, it will be conclusively presumed that the Disclosing Party certified to the above statements.

8. To the best of the Disclosing Party's knowledge after reasonable inquiry, the following is a complete list of all current employees of the Disclosing Party who were, at any time during the 12-month period preceding the execution date of this EDS, an employee, or elected or appointed official, of the City of Chicago (if none, indicate with "N/A" or "none").

NONE

9. To the best of the Disclosing Party's knowledge after reasonable inquiry, the following is a complete list of all gifts that the Disclosing Party has given or caused to be given, at any time during the 12-month period preceding the execution date of this EDS, to an employee, or elected or appointed official, of the City of Chicago. For purposes of this statement, a "gift" does not include: (i) anything made generally available to City employees or to the general public, or (ii) food or drink provided in the course of official City business and having a retail value of less than \$20 per recipient (if none, indicate with "N/A" or "none"). As to any gift listed below, please also list the name of the City recipient.

NONE

C. CERTIFICATION OF STATUS AS FINANCIAL INSTITUTION

1. The Disclosing Party certifies that the Disclosing Party (check one)

is is not

a "financial institution" as defined in Section 2-32-455(b) of the Municipal Code.

2. If the Disclosing Party IS a financial institution, then the Disclosing Party pledges:

"We are not and will not become a predatory lender as defined in Chapter 2-32 of the Municipal Code. We further pledge that none of our affiliates is, and none of them will become, a predatory lender as defined in Chapter 2-32 of the Municipal Code. We understand that becoming a predatory lender or becoming an affiliate of a predatory lender may result in the loss of the privilege of doing business with the City."

If the Disclosing Party is unable to make this pledge because it or any of its affiliates (as defined in Section 2-32-455(b) of the Municipal Code) is a predatory lender within the meaning of Chapter 2-32 of the Municipal Code, explain here (attach additional pages if necessary):

If the letters "NA," the word "None," or no response appears on the lines above, it will be conclusively presumed that the Disclosing Party certified to the above statements.

D. CERTIFICATION REGARDING INTEREST IN CITY BUSINESS

Any words or terms that are defined in Chapter 2-156 of the Municipal Code have the same meanings when used in this Part D.

1. In accordance with Section 2-156-110 of the Municipal Code: Does any official or employee of the City have a financial interest in his or her own name or in the name of any other person or entity in the Matter?

Yes No

NOTE: If you checked "Yes" to Item D.1., proceed to Items D.2. and D.3. If you checked "No" to Item D.1., proceed to Part E.

2. Unless sold pursuant to a process of competitive bidding, or otherwise permitted, no City elected official or employee shall have a financial interest in his or her own name or in the name of any other person or entity in the purchase of any property that (i) belongs to the City, or (ii) is sold for taxes or assessments, or (iii) is sold by virtue of legal process at the suit of the City (collectively, "City Property Sale"). Compensation for property taken pursuant to the City's eminent domain power does not constitute a financial interest within the meaning of this Part D.

Does the Matter involve a City Property Sale?

Yes No

3. If you checked "Yes" to Item D.1., provide the names and business addresses of the City officials or employees having such interest and identify the nature of such interest:

Name	Business Address	Nature of Interest

4. The Disclosing Party further certifies that no prohibited financial interest in the Matter will be acquired by any City official or employee.

E. CERTIFICATION REGARDING SLAVERY ERA BUSINESS

Please check either 1. or 2. below. If the Disclosing Party checks 2., the Disclosing Party must disclose below or in an attachment to this EDS all information required by paragraph 2. Failure to

comply with these disclosure requirements may make any contract entered into with the City in connection with the Matter voidable by the City.

X 1. The Disclosing Party verifies that the Disclosing Party has searched any and all records of the Disclosing Party and any and all predecessor entities regarding records of investments or profits from slavery or slaveholder insurance policies during the slavery era (including insurance policies issued to slaveholders that provided coverage for damage to or injury or death of their slaves), and the Disclosing Party has found no such records.

___ 2. The Disclosing Party verifies that, as a result of conducting the search in step 1 above, the Disclosing Party has found records of investments or profits from slavery or slaveholder insurance policies. The Disclosing Party verifies that the following constitutes full disclosure of all such records, including the names of any and all slaves or slaveholders described in those records:

SECTION VI -- CERTIFICATIONS FOR FEDERALLY FUNDED MATTERS

NOTE: If the Matter is federally funded, complete this Section VI. If the Matter is not federally funded, proceed to Section VII. For purposes of this Section VI, tax credits allocated by the City and proceeds of debt obligations of the City are not federal funding.

A. CERTIFICATION REGARDING LOBBYING

1. List below the names of all persons or entities registered under the federal Lobbying Disclosure Act of 1995 who have made lobbying contacts on behalf of the Disclosing Party with respect to the Matter: (Add sheets if necessary):

(If no explanation appears or begins on the lines above, or if the letters "NA" or if the word "None" appear, it will be conclusively presumed that the Disclosing Party means that NO persons or entities registered under the Lobbying Disclosure Act of 1995 have made lobbying contacts on behalf of the Disclosing Party with respect to the Matter.)

2. The Disclosing Party has not spent and will not expend any federally appropriated funds to pay any person or entity listed in Paragraph A.1. above for his or her lobbying activities or to pay any person or entity to influence or attempt to influence an officer or employee of any agency, as defined by applicable federal law, a member of Congress, an officer or employee of Congress, or an employee of a member of Congress, in connection with the award of any federally funded contract, making any federally funded grant or loan, entering into any cooperative agreement, or to extend, continue, renew, amend, or modify any federally funded contract, grant, loan, or cooperative agreement.

3. The Disclosing Party will submit an updated certification at the end of each calendar quarter in which there occurs any event that materially affects the accuracy of the statements and information set forth in paragraphs A.1. and A.2. above.

4. The Disclosing Party certifies that either: (i) it is not an organization described in section 501(c)(4) of the Internal Revenue Code of 1986; or (ii) it is an organization described in section 501(c)(4) of the Internal Revenue Code of 1986 but has not engaged and will not engage in "Lobbying Activities".

5. If the Disclosing Party is the Applicant, the Disclosing Party must obtain certifications equal in form and substance to paragraphs A.1. through A.4. above from all subcontractors before it awards any subcontract and the Disclosing Party must maintain all such subcontractors' certifications for the duration of the Matter and must make such certifications promptly available to the City upon request.

B. CERTIFICATION REGARDING EQUAL EMPLOYMENT OPPORTUNITY

If the Matter is federally funded, federal regulations require the Applicant and all proposed subcontractors to submit the following information with their bids or in writing at the outset of negotiations.

Is the Disclosing Party the Applicant?

Yes No

If "Yes," answer the three questions below:

1. Have you developed and do you have on file affirmative action programs pursuant to applicable federal regulations? (See 41 CFR Part 60-2.)

Yes No

2. Have you filed with the Joint Reporting Committee, the Director of the Office of Federal Contract Compliance Programs, or the Equal Employment Opportunity Commission all reports due under the applicable filing requirements?

Yes No

3. Have you participated in any previous contracts or subcontracts subject to the equal opportunity clause?

Yes No

If you checked "No" to question 1. or 2. above, please provide an explanation:

SECTION VII -- ACKNOWLEDGMENTS, CONTRACT INCORPORATION, COMPLIANCE, PENALTIES, DISCLOSURE

The Disclosing Party understands and agrees that:

A. The certifications, disclosures, and acknowledgments contained in this EDS will become part of any contract or other agreement between the Applicant and the City in connection with the Matter, whether procurement, City assistance, or other City action, and are material inducements to the City's execution of any contract or taking other action with respect to the Matter. The Disclosing Party understands that it must comply with all statutes, ordinances, and regulations on which this EDS is based.

B. The City's Governmental Ethics and Campaign Financing Ordinances, Chapters 2-156 and 2-164 of the Municipal Code, impose certain duties and obligations on persons or entities seeking City contracts, work, business, or transactions. The full text of these ordinances and a training program is available on line at www.cityofchicago.org/Ethics, and may also be obtained from the City's Board of Ethics, 740 N.

Sedgwick St., Suite 500, Chicago, IL 60610, (312) 744-9660. The Disclosing Party must comply fully with the applicable ordinances.

C. If the City determines that any information provided in this EDS is false, incomplete or inaccurate, any contract or other agreement in connection with which it is submitted may be rescinded or be void or voidable, and the City may pursue any remedies under the contract or agreement (if not rescinded or void), at law, or in equity, including terminating the Disclosing Party's participation in the Matter and/or declining to allow the Disclosing Party to participate in other transactions with the City. Remedies at law for a false statement of material fact may include incarceration and an award to the City of treble damages.

D. It is the City's policy to make this document available to the public on its Internet site and/or upon request. Some or all of the information provided on this EDS and any attachments to this EDS may be made available to the public on the Internet, in response to a Freedom of Information Act request, or otherwise. By completing and signing this EDS, the Disclosing Party waives and releases any possible rights or claims which it may have against the City in connection with the public release of information contained in this EDS and also authorizes the City to verify the accuracy of any information submitted in this EDS.

E. The information provided in this EDS must be kept current. In the event of changes, the Disclosing Party must supplement this EDS up to the time the City takes action on the Matter. If the Matter is a contract being handled by the City's Department of Procurement Services, the Disclosing Party must update this EDS as the contract requires. **NOTE:** With respect to Matters subject to Article I of Chapter 1-23 of the Municipal Code (imposing **PERMANENT INELIGIBILITY** for certain specified offenses), the information provided herein regarding eligibility must be kept current for a longer period, as required by Chapter 1-23 and Section 2-154-020 of the Municipal Code.

The Disclosing Party represents and warrants that:

F.1. The Disclosing Party is not delinquent in the payment of any tax administered by the Illinois Department of Revenue, nor are the Disclosing Party or its Affiliated Entities delinquent in paying any fine, fee, tax or other charge owed to the City. This includes, but is not limited to, all water charges, sewer charges, license fees, parking tickets, property taxes or sales taxes.

F.2 If the Disclosing Party is the Applicant, the Disclosing Party and its Affiliated Entities will not use, nor permit their subcontractors to use, any facility listed by the U.S. E.P.A. on the federal Excluded Parties List System ("EPLS") maintained by the U. S. General Services Administration.

F.3 If the Disclosing Party is the Applicant, the Disclosing Party will obtain from any contractors/subcontractors hired or to be hired in connection with the Matter certifications equal in form and substance to those in F.1. and F.2. above and will not, without the prior written consent of the City, use any such contractor/subcontractor that does not provide such certifications or that the Disclosing Party has reason to believe has not provided or cannot provide truthful certifications.

NOTE: If the Disclosing Party cannot certify as to any of the items in F.1., F.2. or F.3. above, an explanatory statement must be attached to this EDS.

CERTIFICATION

Under penalty of perjury, the person signing below: (1) warrants that he/she is authorized to execute this EDS and Appendix A (if applicable) on behalf of the Disclosing Party, and (2) warrants that all certifications and statements contained in this EDS and Appendix A (if applicable) are true, accurate and complete as of the date furnished to the City.

Chicago IL (1150 Halsted) LLC
(Print or type name of Disclosing Party)

By: *Robin Rash*
(Sign here)

Robin Rash
(Print or type name of person signing)

Manager
(Print or type title of person signing)

Signed and sworn to before me on (date) October 7, 2013,
at DuPage County, Illinois (state).

Virginia M. Lunsford Notary Public

Commission expires: 8-14-2014

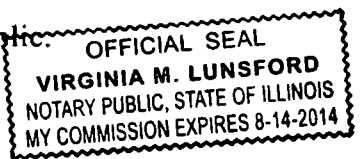

**CITY OF CHICAGO
ECONOMIC DISCLOSURE STATEMENT AND AFFIDAVIT
APPENDIX A**

FAMILIAL RELATIONSHIPS WITH ELECTED CITY OFFICIALS AND DEPARTMENT HEADS

This Appendix is to be completed only by (a) the Applicant, and (b) any legal entity which has a direct ownership interest in the Applicant exceeding 7.5 percent. It is not to be completed by any legal entity which has only an indirect ownership interest in the Applicant.

Under Municipal Code Section 2-154-015, the Disclosing Party must disclose whether such Disclosing Party or any "Applicable Party" or any Spouse or Domestic Partner thereof currently has a "familial relationship" with any elected city official or department head. A "familial relationship" exists if, as of the date this EDS is signed, the Disclosing Party or any "Applicable Party" or any Spouse or Domestic Partner thereof is related to the mayor, any alderman, the city clerk, the city treasurer or any city department head as spouse or domestic partner or as any of the following, whether by blood or adoption: parent, child, brother or sister, aunt or uncle, niece or nephew, grandparent, grandchild, father-in-law, mother-in-law, son-in-law, daughter-in-law, stepfather or stepmother, stepson or stepdaughter, stepbrother or stepsister or half-brother or half-sister.

"Applicable Party" means (1) all executive officers of the Disclosing Party listed in Section II.B.1.a., if the Disclosing Party is a corporation; all partners of the Disclosing Party, if the Disclosing Party is a general partnership; all general partners and limited partners of the Disclosing Party, if the Disclosing Party is a limited partnership; all managers, managing members and members of the Disclosing Party, if the Disclosing Party is a limited liability company; (2) all principal officers of the Disclosing Party; and (3) any person having more than a 7.5 percent ownership interest in the Disclosing Party. "Principal officers" means the president, chief operating officer, executive director, chief financial officer, treasurer or secretary of a legal entity or any person exercising similar authority.

Does the Disclosing Party or any "Applicable Party" or any Spouse or Domestic Partner thereof currently have a "familial relationship" with an elected city official or department head?

Yes

No

If yes, please identify below (1) the name and title of such person, (2) the name of the legal entity to which such person is connected; (3) the name and title of the elected city official or department head to whom such person has a familial relationship, and (4) the precise nature of such familial relationship.

**CITY OF CHICAGO
ECONOMIC DISCLOSURE STATEMENT
AND AFFIDAVIT**

SECTION I – GENERAL INFORMATION

A. Legal name of the Disclosing Party submitting this EDS. Include d/b/a/ if applicable:

Toledo Holdings LLC, an Illinois limited liability company

Check ONE of the following three boxes:

Indicate whether the Disclosing Party submitting this EDS is:

1. the Applicant

OR

2. a legal entity holding a direct or indirect interest in the Applicant. State the legal name of the Applicant in which the Disclosing Party holds an interest: Chicago IL (1150 Halsted) LLC

OR

3. a legal entity with a right of control (see Section II.B.1.) State the legal name of the entity in which the Disclosing Party holds a right of control: _____

B. Business address of the Disclosing Party: c/o InSite Real Estate, L.L.C.

1400 16th Street, Suite 300

Oak Brook, Illinois 60523

C. Telephone: 630/617-9100 Fax: 630/617-9120 Email: rrash@insiterealestate.com

D. Name of contact person: Robin Rash

E. Federal Employer Identification No. (if you have one): _____

F. Brief description of contract, transaction or other undertaking (referred to below as the "Matter") to which this EDS pertains. (Include project number and location of property, if applicable):

PD application for property at 1150-1168 North Halsted, Chicago, Illinois

G. Which City agency or department is requesting this EDS? DHED, Law Dept.

If the Matter is a contract being handled by the City's Department of Procurement Services, please complete the following:

Specification # _____ and Contract # _____

SECTION II -- DISCLOSURE OF OWNERSHIP INTERESTS

A. NATURE OF THE DISCLOSING PARTY

1. Indicate the nature of the Disclosing Party:

- Person
- Limited liability company
- Publicly registered business corporation
- Limited liability partnership
- Privately held business corporation
- Joint venture
- Sole proprietorship
- Not-for-profit corporation
- General partnership
- (Is the not-for-profit corporation also a 501(c)(3))?
- Limited partnership
- Yes No
- Trust
- Other (please specify)

2. For legal entities, the state (or foreign country) of incorporation or organization, if applicable:

Illinois

3. For legal entities not organized in the State of Illinois: Has the organization registered to do business in the State of Illinois as a foreign entity?

- Yes
- No
- N/A

B. IF THE DISCLOSING PARTY IS A LEGAL ENTITY:

1. List below the full names and titles of all executive officers and all directors of the entity.

NOTE: For not-for-profit corporations, also list below all members, if any, which are legal entities. If there are no such members, write "no members." For trusts, estates or other similar entities, list below the legal titleholder(s).

If the entity is a general partnership, limited partnership, limited liability company, limited liability partnership or joint venture, list below the name and title of each general partner, managing member, manager or any other person or entity that controls the day-to-day management of the Disclosing Party.

NOTE: Each legal entity listed below must submit an EDS on its own behalf.

Name	Title
Gerald J. Kostelny	Manager and Managing Director
Robin Rash	Manager
Christopher G. Hutter	Manager

2. Please provide the following information concerning each person or entity having a direct or indirect beneficial interest (including ownership) in excess of 7.5% of the Disclosing Party. Examples of such an interest include shares in a corporation, partnership interest in a partnership or joint venture,

interest of a member or manager in a limited liability company, or interest of a beneficiary of a trust, estate or other similar entity. If none, state "None." **NOTE:** Pursuant to Section 2-154-030 of the Municipal Code of Chicago ("Municipal Code"), the City may require any such additional information from any applicant which is reasonably intended to achieve full disclosure.

Name	Business Address	Percentage Interest in the Disclosing Party
InSite Capital, L.L.C.	1400 16th Street, Suite 300 Oak Brook, Illinois 60523	10%
ICM Partners LLC	1400 16th Street, Suite 300 Oak Brook, Illinois 60523	90%

SECTION III -- BUSINESS RELATIONSHIPS WITH CITY ELECTED OFFICIALS

Has the Disclosing Party had a "business relationship," as defined in Chapter 2-156 of the Municipal Code, with any City elected official in the 12 months before the date this EDS is signed?

Yes No

If yes, please identify below the name(s) of such City elected official(s) and describe such relationship(s):

SECTION IV -- DISCLOSURE OF SUBCONTRACTORS AND OTHER RETAINED PARTIES

The Disclosing Party must disclose the name and business address of each subcontractor, attorney, lobbyist, accountant, consultant and any other person or entity whom the Disclosing Party has retained or expects to retain in connection with the Matter, as well as the nature of the relationship, and the total amount of the fees paid or estimated to be paid. The Disclosing Party is not required to disclose employees who are paid solely through the Disclosing Party's regular payroll.

“Lobbyist” means any person or entity who undertakes to influence any legislative or administrative action on behalf of any person or entity other than: (1) a not-for-profit entity, on an unpaid basis, or (2) himself. “Lobbyist” also means any person or entity any part of whose duties as an employee of another includes undertaking to influence any legislative or administrative action.

If the Disclosing Party is uncertain whether a disclosure is required under this Section, the Disclosing Party must either ask the City whether disclosure is required or make the disclosure.

Name (indicate whether retained or anticipated to be retained)	Business Address	Relationship to Disclosing Party (subcontractor, attorney, lobbyist, etc.)	Fees (indicate whether paid or estimated.) NOTE: "hourly rate" or "t.b.d." is not an acceptable response.
--	------------------	--	---

(Add sheets if necessary)

Check here if the Disclosing Party has not retained, nor expects to retain, any such persons or entities.

SECTION V -- CERTIFICATIONS

A. COURT-ORDERED CHILD SUPPORT COMPLIANCE

Under Municipal Code Section 2-92-415, substantial owners of business entities that contract with the City must remain in compliance with their child support obligations throughout the contract's term.

Has any person who directly or indirectly owns 10% or more of the Disclosing Party been declared in arrearage on any child support obligations by any Illinois court of competent jurisdiction?

Yes No No person directly or indirectly owns 10% or more of the Disclosing Party.

If "Yes," has the person entered into a court-approved agreement for payment of all support owed and is the person in compliance with that agreement?

Yes No

B. FURTHER CERTIFICATIONS

1. Pursuant to Municipal Code Chapter 1-23, Article I ("Article I")(which the Applicant should consult for defined terms (e.g., "doing business") and legal requirements), if the Disclosing Party submitting this EDS is the Applicant and is doing business with the City, then the Disclosing Party certifies as follows: (i) neither the Applicant nor any controlling person is currently indicted or charged with, or has admitted guilt of, or has ever been convicted of, or placed under supervision for, any criminal offense involving actual, attempted, or conspiracy to commit bribery, theft, fraud, forgery, perjury, dishonesty or deceit against an officer or employee of the City or any sister agency; and (ii) the Applicant understands and acknowledges that compliance with Article I is a continuing requirement for doing business with the City. NOTE: If Article I applies to the Applicant, the permanent compliance timeframe in Article I supersedes some five-year compliance timeframes in certifications 2 and 3 below.

2. The Disclosing Party and, if the Disclosing Party is a legal entity, all of those persons or entities identified in Section II.B.1. of this EDS:

- a. are not presently debarred, suspended, proposed for debarment, declared ineligible or voluntarily excluded from any transactions by any federal, state or local unit of government;
- b. have not, within a five-year period preceding the date of this EDS, been convicted of a criminal offense, adjudged guilty, or had a civil judgment rendered against them in connection with: obtaining, attempting to obtain, or performing a public (federal, state or local) transaction or contract under a public transaction; a violation of federal or state antitrust statutes; fraud; embezzlement; theft; forgery; bribery; falsification or destruction of records; making false statements; or receiving stolen property;
- c. are not presently indicted for, or criminally or civilly charged by, a governmental entity (federal, state or local) with committing any of the offenses set forth in clause B.2.b. of this Section V;
- d. have not, within a five-year period preceding the date of this EDS, had one or more public transactions (federal, state or local) terminated for cause or default; and
- e. have not, within a five-year period preceding the date of this EDS, been convicted, adjudged guilty, or found liable in a civil proceeding, or in any criminal or civil action, including actions concerning environmental violations, instituted by the City or by the federal government, any state, or any other unit of local government.

3. The certifications in subparts 3, 4 and 5 concern:

- the Disclosing Party;
- any "Contractor" (meaning any contractor or subcontractor used by the Disclosing Party in connection with the Matter, including but not limited to all persons or legal entities disclosed under Section IV, "Disclosure of Subcontractors and Other Retained Parties");
- any "Affiliated Entity" (meaning a person or entity that, directly or indirectly: controls the Disclosing Party, is controlled by the Disclosing Party, or is, with the Disclosing Party, under common control of another person or entity. Indicia of control include, without limitation: interlocking management or ownership; identity of interests among family members, shared facilities and equipment; common use of employees; or organization of a business entity following the ineligibility of a business entity to do business with federal or state or local government, including the City, using substantially the same management, ownership, or principals as the ineligible entity); with respect to Contractors, the term Affiliated Entity means a person or entity that directly or indirectly controls the Contractor, is controlled by it, or, with the Contractor, is under common control of another person or entity;
- any responsible official of the Disclosing Party, any Contractor or any Affiliated Entity or any other official, agent or employee of the Disclosing Party, any Contractor or any Affiliated Entity, acting pursuant to the direction or authorization of a responsible official of the Disclosing Party, any Contractor or any Affiliated Entity (collectively "Agents").

Neither the Disclosing Party, nor any Contractor, nor any Affiliated Entity of either the Disclosing Party or any Contractor nor any Agents have, during the five years before the date this EDS is signed, or, with respect to a Contractor, an Affiliated Entity, or an Affiliated Entity of a Contractor during the five years before the date of such Contractor's or Affiliated Entity's contract or engagement in connection with the Matter:

- a. bribed or attempted to bribe, or been convicted or adjudged guilty of bribery or attempting to bribe, a public officer or employee of the City, the State of Illinois, or any agency of the federal government or of any state or local government in the United States of America, in that officer's or employee's official capacity;
- b. agreed or colluded with other bidders or prospective bidders, or been a party to any such agreement, or been convicted or adjudged guilty of agreement or collusion among bidders or prospective bidders, in restraint of freedom of competition by agreement to bid a fixed price or otherwise; or
- c. made an admission of such conduct described in a. or b. above that is a matter of record, but have not been prosecuted for such conduct; or
- d. violated the provisions of Municipal Code Section 2-92-610 (Living Wage Ordinance).

4. Neither the Disclosing Party, Affiliated Entity or Contractor, or any of their employees, officials, agents or partners, is barred from contracting with any unit of state or local government as a result of engaging in or being convicted of (1) bid-rigging in violation of 720 ILCS 5/33E-3; (2) bid-rotating in violation of 720 ILCS 5/33E-4; or (3) any similar offense of any state or of the United States of America that contains the same elements as the offense of bid-rigging or bid-rotating.

5. Neither the Disclosing Party nor any Affiliated Entity is listed on any of the following lists maintained by the Office of Foreign Assets Control of the U.S. Department of the Treasury or the Bureau of Industry and Security of the U.S. Department of Commerce or their successors: the Specially Designated Nationals List, the Denied Persons List, the Unverified List, the Entity List and the Debarred List.

6. The Disclosing Party understands and shall comply with the applicable requirements of Chapters 2-55 (Legislative Inspector General), 2-56 (Inspector General) and 2-156 (Governmental Ethics) of the Municipal Code.

7. If the Disclosing Party is unable to certify to any of the above statements in this Part B (Further Certifications), the Disclosing Party must explain below:

If the letters "NA," the word "None," or no response appears on the lines above, it will be conclusively presumed that the Disclosing Party certified to the above statements.

8. To the best of the Disclosing Party's knowledge after reasonable inquiry, the following is a complete list of all current employees of the Disclosing Party who were, at any time during the 12-month period preceding the execution date of this EDS, an employee, or elected or appointed official, of the City of Chicago (if none, indicate with "N/A" or "none").

NONE

9. To the best of the Disclosing Party's knowledge after reasonable inquiry, the following is a complete list of all gifts that the Disclosing Party has given or caused to be given, at any time during the 12-month period preceding the execution date of this EDS, to an employee, or elected or appointed official, of the City of Chicago. For purposes of this statement, a "gift" does not include: (i) anything made generally available to City employees or to the general public, or (ii) food or drink provided in the course of official City business and having a retail value of less than \$20 per recipient (if none, indicate with "N/A" or "none"). As to any gift listed below, please also list the name of the City recipient.

NONE

C. CERTIFICATION OF STATUS AS FINANCIAL INSTITUTION

1. The Disclosing Party certifies that the Disclosing Party (check one)

is is not

a "financial institution" as defined in Section 2-32-455(b) of the Municipal Code.

2. If the Disclosing Party IS a financial institution, then the Disclosing Party pledges:

"We are not and will not become a predatory lender as defined in Chapter 2-32 of the Municipal Code. We further pledge that none of our affiliates is, and none of them will become, a predatory lender as defined in Chapter 2-32 of the Municipal Code. We understand that becoming a predatory lender or becoming an affiliate of a predatory lender may result in the loss of the privilege of doing business with the City."

If the Disclosing Party is unable to make this pledge because it or any of its affiliates (as defined in Section 2-32-455(b) of the Municipal Code) is a predatory lender within the meaning of Chapter 2-32 of the Municipal Code, explain here (attach additional pages if necessary):

If the letters "NA," the word "None," or no response appears on the lines above, it will be conclusively presumed that the Disclosing Party certified to the above statements.

D. CERTIFICATION REGARDING INTEREST IN CITY BUSINESS

Any words or terms that are defined in Chapter 2-156 of the Municipal Code have the same meanings when used in this Part D.

1. In accordance with Section 2-156-110 of the Municipal Code: Does any official or employee of the City have a financial interest in his or her own name or in the name of any other person or entity in the Matter?

Yes No

NOTE: If you checked "Yes" to Item D.1., proceed to Items D.2. and D.3. If you checked "No" to Item D.1., proceed to Part E.

2. Unless sold pursuant to a process of competitive bidding, or otherwise permitted, no City elected official or employee shall have a financial interest in his or her own name or in the name of any other person or entity in the purchase of any property that (i) belongs to the City, or (ii) is sold for taxes or assessments, or (iii) is sold by virtue of legal process at the suit of the City (collectively, "City Property Sale"). Compensation for property taken pursuant to the City's eminent domain power does not constitute a financial interest within the meaning of this Part D.

Does the Matter involve a City Property Sale?

Yes No

3. If you checked "Yes" to Item D.1., provide the names and business addresses of the City officials or employees having such interest and identify the nature of such interest:

Name	Business Address	Nature of Interest

4. The Disclosing Party further certifies that no prohibited financial interest in the Matter will be acquired by any City official or employee.

E. CERTIFICATION REGARDING SLAVERY ERA BUSINESS

Please check either 1. or 2. below. If the Disclosing Party checks 2., the Disclosing Party must disclose below or in an attachment to this EDS all information required by paragraph 2. Failure to

comply with these disclosure requirements may make any contract entered into with the City in connection with the Matter voidable by the City.

X 1. The Disclosing Party verifies that the Disclosing Party has searched any and all records of the Disclosing Party and any and all predecessor entities regarding records of investments or profits from slavery or slaveholder insurance policies during the slavery era (including insurance policies issued to slaveholders that provided coverage for damage to or injury or death of their slaves), and the Disclosing Party has found no such records.

____ 2. The Disclosing Party verifies that, as a result of conducting the search in step 1 above, the Disclosing Party has found records of investments or profits from slavery or slaveholder insurance policies. The Disclosing Party verifies that the following constitutes full disclosure of all such records, including the names of any and all slaves or slaveholders described in those records:

SECTION VI -- CERTIFICATIONS FOR FEDERALLY FUNDED MATTERS

NOTE: If the Matter is federally funded, complete this Section VI. If the Matter is not federally funded, proceed to Section VII. For purposes of this Section VI, tax credits allocated by the City and proceeds of debt obligations of the City are not federal funding.

A. CERTIFICATION REGARDING LOBBYING

1. List below the names of all persons or entities registered under the federal Lobbying Disclosure Act of 1995 who have made lobbying contacts on behalf of the Disclosing Party with respect to the Matter: (Add sheets if necessary):

(If no explanation appears or begins on the lines above, or if the letters "NA" or if the word "None" appear, it will be conclusively presumed that the Disclosing Party means that NO persons or entities registered under the Lobbying Disclosure Act of 1995 have made lobbying contacts on behalf of the Disclosing Party with respect to the Matter.)

2. The Disclosing Party has not spent and will not expend any federally appropriated funds to pay any person or entity listed in Paragraph A.1. above for his or her lobbying activities or to pay any person or entity to influence or attempt to influence an officer or employee of any agency, as defined by applicable federal law, a member of Congress, an officer or employee of Congress, or an employee of a member of Congress, in connection with the award of any federally funded contract, making any federally funded grant or loan, entering into any cooperative agreement, or to extend, continue, renew, amend, or modify any federally funded contract, grant, loan, or cooperative agreement.

3. The Disclosing Party will submit an updated certification at the end of each calendar quarter in which there occurs any event that materially affects the accuracy of the statements and information set forth in paragraphs A.1. and A.2. above.

4. The Disclosing Party certifies that either: (i) it is not an organization described in section 501(c)(4) of the Internal Revenue Code of 1986; or (ii) it is an organization described in section 501(c)(4) of the Internal Revenue Code of 1986 but has not engaged and will not engage in "Lobbying Activities".

5. If the Disclosing Party is the Applicant, the Disclosing Party must obtain certifications equal in form and substance to paragraphs A.1. through A.4. above from all subcontractors before it awards any subcontract and the Disclosing Party must maintain all such subcontractors' certifications for the duration of the Matter and must make such certifications promptly available to the City upon request.

B. CERTIFICATION REGARDING EQUAL EMPLOYMENT OPPORTUNITY

If the Matter is federally funded, federal regulations require the Applicant and all proposed subcontractors to submit the following information with their bids or in writing at the outset of negotiations.

Is the Disclosing Party the Applicant?

Yes No

If "Yes," answer the three questions below:

1. Have you developed and do you have on file affirmative action programs pursuant to applicable federal regulations? (See 41 CFR Part 60-2.)

Yes No

2. Have you filed with the Joint Reporting Committee, the Director of the Office of Federal Contract Compliance Programs, or the Equal Employment Opportunity Commission all reports due under the applicable filing requirements?

Yes No

3. Have you participated in any previous contracts or subcontracts subject to the equal opportunity clause?

Yes No

If you checked "No" to question 1. or 2. above, please provide an explanation:

SECTION VII -- ACKNOWLEDGMENTS, CONTRACT INCORPORATION, COMPLIANCE, PENALTIES, DISCLOSURE

The Disclosing Party understands and agrees that:

A. The certifications, disclosures, and acknowledgments contained in this EDS will become part of any contract or other agreement between the Applicant and the City in connection with the Matter, whether procurement, City assistance, or other City action, and are material inducements to the City's execution of any contract or taking other action with respect to the Matter. The Disclosing Party understands that it must comply with all statutes, ordinances, and regulations on which this EDS is based.

B. The City's Governmental Ethics and Campaign Financing Ordinances, Chapters 2-156 and 2-164 of the Municipal Code, impose certain duties and obligations on persons or entities seeking City contracts, work, business, or transactions. The full text of these ordinances and a training program is available on line at www.cityofchicago.org/Ethics, and may also be obtained from the City's Board of Ethics, 740 N.

Sedgwick St., Suite 500, Chicago, IL 60610, (312) 744-9660. The Disclosing Party must comply fully with the applicable ordinances.

C. If the City determines that any information provided in this EDS is false, incomplete or inaccurate, any contract or other agreement in connection with which it is submitted may be rescinded or be void or voidable, and the City may pursue any remedies under the contract or agreement (if not rescinded or void), at law, or in equity, including terminating the Disclosing Party's participation in the Matter and/or declining to allow the Disclosing Party to participate in other transactions with the City. Remedies at law for a false statement of material fact may include incarceration and an award to the City of treble damages.

D. It is the City's policy to make this document available to the public on its Internet site and/or upon request. Some or all of the information provided on this EDS and any attachments to this EDS may be made available to the public on the Internet, in response to a Freedom of Information Act request, or otherwise. By completing and signing this EDS, the Disclosing Party waives and releases any possible rights or claims which it may have against the City in connection with the public release of information contained in this EDS and also authorizes the City to verify the accuracy of any information submitted in this EDS.

E. The information provided in this EDS must be kept current. In the event of changes, the Disclosing Party must supplement this EDS up to the time the City takes action on the Matter. If the Matter is a contract being handled by the City's Department of Procurement Services, the Disclosing Party must update this EDS as the contract requires. **NOTE:** With respect to Matters subject to Article I of Chapter 1-23 of the Municipal Code (imposing **PERMANENT INELIGIBILITY** for certain specified offenses), the information provided herein regarding eligibility must be kept current for a longer period, as required by Chapter 1-23 and Section 2-154-020 of the Municipal Code.

The Disclosing Party represents and warrants that:

F.1. The Disclosing Party is not delinquent in the payment of any tax administered by the Illinois Department of Revenue, nor are the Disclosing Party or its Affiliated Entities delinquent in paying any fine, fee, tax or other charge owed to the City. This includes, but is not limited to, all water charges, sewer charges, license fees, parking tickets, property taxes or sales taxes.

F.2 If the Disclosing Party is the Applicant, the Disclosing Party and its Affiliated Entities will not use, nor permit their subcontractors to use, any facility listed by the U.S. E.P.A. on the federal Excluded Parties List System ("EPLS") maintained by the U. S. General Services Administration.

F.3 If the Disclosing Party is the Applicant, the Disclosing Party will obtain from any contractors/subcontractors hired or to be hired in connection with the Matter certifications equal in form and substance to those in F.1. and F.2. above and will not, without the prior written consent of the City, use any such contractor/subcontractor that does not provide such certifications or that the Disclosing Party has reason to believe has not provided or cannot provide truthful certifications.

NOTE: If the Disclosing Party cannot certify as to any of the items in F.1., F.2. or F.3. above, an explanatory statement must be attached to this EDS.

CERTIFICATION

Under penalty of perjury, the person signing below: (1) warrants that he/she is authorized to execute this EDS and Appendix A (if applicable) on behalf of the Disclosing Party, and (2) warrants that all certifications and statements contained in this EDS and Appendix A (if applicable) are true, accurate and complete as of the date furnished to the City.

Toledo Holdings LLC

(Print or type name of Disclosing Party)

By: 
(Sign here)

Robin Rash

(Print or type name of person signing)

Manager

(Print or type title of person signing)

Signed and sworn to before me on (date) October 7, 2013,
at DuPage County, Illinois (state).

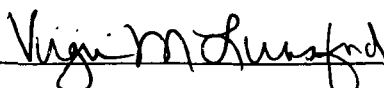
 Notary Public.

Commission expires: 8.14.2014

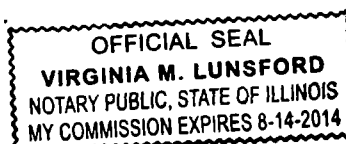

**CITY OF CHICAGO
ECONOMIC DISCLOSURE STATEMENT AND AFFIDAVIT
APPENDIX A**

FAMILIAL RELATIONSHIPS WITH ELECTED CITY OFFICIALS AND DEPARTMENT HEADS

This Appendix is to be completed only by (a) the Applicant, and (b) any legal entity which has a direct ownership interest in the Applicant exceeding 7.5 percent. It is not to be completed by any legal entity which has only an indirect ownership interest in the Applicant.

Under Municipal Code Section 2-154-015, the Disclosing Party must disclose whether such Disclosing Party or any "Applicable Party" or any Spouse or Domestic Partner thereof currently has a "familial relationship" with any elected city official or department head. A "familial relationship" exists if, as of the date this EDS is signed, the Disclosing Party or any "Applicable Party" or any Spouse or Domestic Partner thereof is related to the mayor, any alderman, the city clerk, the city treasurer or any city department head as spouse or domestic partner or as any of the following, whether by blood or adoption: parent, child, brother or sister, aunt or uncle, niece or nephew, grandparent, grandchild, father-in-law, mother-in-law, son-in-law, daughter-in-law, stepfather or stepmother, stepson or stepdaughter, stepbrother or stepsister or half-brother or half-sister.

"Applicable Party" means (1) all executive officers of the Disclosing Party listed in Section II.B.1.a., if the Disclosing Party is a corporation; all partners of the Disclosing Party, if the Disclosing Party is a general partnership; all general partners and limited partners of the Disclosing Party, if the Disclosing Party is a limited partnership; all managers, managing members and members of the Disclosing Party, if the Disclosing Party is a limited liability company; (2) all principal officers of the Disclosing Party; and (3) any person having more than a 7.5 percent ownership interest in the Disclosing Party. "Principal officers" means the president, chief operating officer, executive director, chief financial officer, treasurer or secretary of a legal entity or any person exercising similar authority.

Does the Disclosing Party or any "Applicable Party" or any Spouse or Domestic Partner thereof currently have a "familial relationship" with an elected city official or department head?

Yes

No

If yes, please identify below (1) the name and title of such person, (2) the name of the legal entity to which such person is connected; (3) the name and title of the elected city official or department head to whom such person has a familial relationship, and (4) the precise nature of such familial relationship.

**CITY OF CHICAGO
ECONOMIC DISCLOSURE STATEMENT
AND AFFIDAVIT**

SECTION I -- GENERAL INFORMATION

A. Legal name of the Disclosing Party submitting this EDS. Include d/b/a/ if applicable:

ICM Partners LLC, an Illinois limited liability company

Check ONE of the following three boxes:

Indicate whether the Disclosing Party submitting this EDS is:

1. the Applicant
OR

2. a legal entity holding a direct or indirect interest in the Applicant. State the legal name of the Applicant in which the Disclosing Party holds an interest: Chicago IL (1150 Halsted) LLC
OR

3. a legal entity with a right of control (see Section II.B.1.) State the legal name of the entity in which the Disclosing Party holds a right of control: _____

B. Business address of the Disclosing Party: c/o InSite Real Estate, L.L.C.
1400 16th Street, Suite 300
Oak Brook, Illinois 60523

C. Telephone: 630/617-9100 Fax: 630/617-9120 Email: rrash@insiterealestate.com

D. Name of contact person: Robin Rash

E. Federal Employer Identification No. (if you have one): _____

F. Brief description of contract, transaction or other undertaking (referred to below as the "Matter") to which this EDS pertains. (Include project number and location of property, if applicable):

PD application for property at 1150-1168 North Halsted, Chicago, Illinois

G. Which City agency or department is requesting this EDS? DHED, Law Dept.

If the Matter is a contract being handled by the City's Department of Procurement Services, please complete the following:

Specification # _____ and Contract # _____

SECTION II -- DISCLOSURE OF OWNERSHIP INTERESTS

A. NATURE OF THE DISCLOSING PARTY

1. Indicate the nature of the Disclosing Party:

- Person
- Publicly registered business corporation
- Privately held business corporation
- Sole proprietorship
- General partnership
- Limited partnership
- Trust
- Limited liability company
- Limited liability partnership
- Joint venture
- Not-for-profit corporation
(Is the not-for-profit corporation also a 501(c)(3))?
 Yes No
- Other (please specify)

2. For legal entities, the state (or foreign country) of incorporation or organization, if applicable:

Illinois

3. For legal entities not organized in the State of Illinois: Has the organization registered to do business in the State of Illinois as a foreign entity?

- Yes No N/A

B. IF THE DISCLOSING PARTY IS A LEGAL ENTITY:

1. List below the full names and titles of all executive officers and all directors of the entity.

NOTE: For not-for-profit corporations, also list below all members, if any, which are legal entities. If there are no such members, write "no members." For trusts, estates or other similar entities, list below the legal titleholder(s).

If the entity is a general partnership, limited partnership, limited liability company, limited liability partnership or joint venture, list below the name and title of each general partner, managing member, manager or any other person or entity that controls the day-to-day management of the Disclosing Party.

NOTE: Each legal entity listed below must submit an EDS on its own behalf.

Name	Title
Gerald J. Kostelny	Manager and Managing Director
Robin Rash	Manager
Christopher G. Hutter	Manager

2. Please provide the following information concerning each person or entity having a direct or indirect beneficial interest (including ownership) in excess of 7.5% of the Disclosing Party. Examples of such an interest include shares in a corporation, partnership interest in a partnership or joint venture,

interest of a member or manager in a limited liability company, or interest of a beneficiary of a trust, estate or other similar entity. If none, state "None." **NOTE:** Pursuant to Section 2-154-030 of the Municipal Code of Chicago ("Municipal Code"), the City may require any such additional information from any applicant which is reasonably intended to achieve full disclosure.

Name	Business Address	Percentage Interest in the Disclosing Party
Carolyn C. Kostelny	1400 16th Street, Suite 300 Oak Brook, Illinois 60523	51%
Gerald J. Kostelny	1400 16th Street, Suite 300 Oak Brook, Illinois 60523	49%

SECTION III -- BUSINESS RELATIONSHIPS WITH CITY ELECTED OFFICIALS

Has the Disclosing Party had a "business relationship," as defined in Chapter 2-156 of the Municipal Code, with any City elected official in the 12 months before the date this EDS is signed?

Yes No

If yes, please identify below the name(s) of such City elected official(s) and describe such relationship(s):

SECTION IV -- DISCLOSURE OF SUBCONTRACTORS AND OTHER RETAINED PARTIES

The Disclosing Party must disclose the name and business address of each subcontractor, attorney, lobbyist, accountant, consultant and any other person or entity whom the Disclosing Party has retained or expects to retain in connection with the Matter, as well as the nature of the relationship, and the total amount of the fees paid or estimated to be paid. The Disclosing Party is not required to disclose employees who are paid solely through the Disclosing Party's regular payroll.

"Lobbyist" means any person or entity who undertakes to influence any legislative or administrative action on behalf of any person or entity other than: (1) a not-for-profit entity, on an unpaid basis, or (2) himself. "Lobbyist" also means any person or entity any part of whose duties as an employee of another includes undertaking to influence any legislative or administrative action.

If the Disclosing Party is uncertain whether a disclosure is required under this Section, the Disclosing Party must either ask the City whether disclosure is required or make the disclosure.

Name (indicate whether retained or anticipated to be retained)	Business Address	Relationship to Disclosing Party (subcontractor, attorney, lobbyist, etc.)	Fees (indicate whether paid or estimated.) NOTE: "hourly rate" or "t.b.d." is not an acceptable response.
--	------------------	--	--

(Add sheets if necessary)

Check here if the Disclosing Party has not retained, nor expects to retain, any such persons or entities.

SECTION V -- CERTIFICATIONS

A. COURT-ORDERED CHILD SUPPORT COMPLIANCE

Under Municipal Code Section 2-92-415, substantial owners of business entities that contract with the City must remain in compliance with their child support obligations throughout the contract's term.

Has any person who directly or indirectly owns 10% or more of the Disclosing Party been declared in arrearage on any child support obligations by any Illinois court of competent jurisdiction?

Yes No No person directly or indirectly owns 10% or more of the Disclosing Party.

If "Yes," has the person entered into a court-approved agreement for payment of all support owed and is the person in compliance with that agreement?

Yes No

B. FURTHER CERTIFICATIONS

1. Pursuant to Municipal Code Chapter 1-23, Article I ("Article I")(which the Applicant should consult for defined terms (e.g., "doing business") and legal requirements), if the Disclosing Party submitting this EDS is the Applicant and is doing business with the City, then the Disclosing Party certifies as follows: (i) neither the Applicant nor any controlling person is currently indicted or charged with, or has admitted guilt of, or has ever been convicted of, or placed under supervision for, any criminal offense involving actual, attempted, or conspiracy to commit bribery, theft, fraud, forgery, perjury, dishonesty or deceit against an officer or employee of the City or any sister agency; and (ii) the Applicant understands and acknowledges that compliance with Article I is a continuing requirement for doing business with the City. **NOTE:** If Article I applies to the Applicant, the permanent compliance timeframe in Article I supersedes some five-year compliance timeframes in certifications 2 and 3 below.

2. The Disclosing Party and, if the Disclosing Party is a legal entity, all of those persons or entities identified in Section II.B.1. of this EDS:

- a. are not presently debarred, suspended, proposed for debarment, declared ineligible or voluntarily excluded from any transactions by any federal, state or local unit of government;
- b. have not, within a five-year period preceding the date of this EDS, been convicted of a criminal offense, adjudged guilty, or had a civil judgment rendered against them in connection with: obtaining, attempting to obtain, or performing a public (federal, state or local) transaction or contract under a public transaction; a violation of federal or state antitrust statutes; fraud; embezzlement; theft; forgery; bribery; falsification or destruction of records; making false statements; or receiving stolen property;
- c. are not presently indicted for, or criminally or civilly charged by, a governmental entity (federal, state or local) with committing any of the offenses set forth in clause B.2.b. of this Section V;
- d. have not, within a five-year period preceding the date of this EDS, had one or more public transactions (federal, state or local) terminated for cause or default; and
- e. have not, within a five-year period preceding the date of this EDS, been convicted, adjudged guilty, or found liable in a civil proceeding, or in any criminal or civil action, including actions concerning environmental violations, instituted by the City or by the federal government, any state, or any other unit of local government.

3. The certifications in subparts 3, 4 and 5 concern:

- the Disclosing Party;
- any "Contractor" (meaning any contractor or subcontractor used by the Disclosing Party in connection with the Matter, including but not limited to all persons or legal entities disclosed under Section IV, "Disclosure of Subcontractors and Other Retained Parties");
- any "Affiliated Entity" (meaning a person or entity that, directly or indirectly: controls the Disclosing Party, is controlled by the Disclosing Party, or is, with the Disclosing Party, under common control of another person or entity. Indicia of control include, without limitation: interlocking management or ownership; identity of interests among family members, shared facilities and equipment; common use of employees; or organization of a business entity following the ineligibility of a business entity to do business with federal or state or local government, including the City, using substantially the same management, ownership, or principals as the ineligible entity); with respect to Contractors, the term Affiliated Entity means a person or entity that directly or indirectly controls the Contractor, is controlled by it, or, with the Contractor, is under common control of another person or entity;
- any responsible official of the Disclosing Party, any Contractor or any Affiliated Entity or any other official, agent or employee of the Disclosing Party, any Contractor or any Affiliated Entity, acting pursuant to the direction or authorization of a responsible official of the Disclosing Party, any Contractor or any Affiliated Entity (collectively "Agents").

Neither the Disclosing Party, nor any Contractor, nor any Affiliated Entity of either the Disclosing Party or any Contractor nor any Agents have, during the five years before the date this EDS is signed, or, with respect to a Contractor, an Affiliated Entity, or an Affiliated Entity of a Contractor during the five years before the date of such Contractor's or Affiliated Entity's contract or engagement in connection with the Matter:

- a. bribed or attempted to bribe, or been convicted or adjudged guilty of bribery or attempting to bribe, a public officer or employee of the City, the State of Illinois, or any agency of the federal government or of any state or local government in the United States of America, in that officer's or employee's official capacity;
- b. agreed or colluded with other bidders or prospective bidders, or been a party to any such agreement, or been convicted or adjudged guilty of agreement or collusion among bidders or prospective bidders, in restraint of freedom of competition by agreement to bid a fixed price or otherwise; or
- c. made an admission of such conduct described in a. or b. above that is a matter of record, but have not been prosecuted for such conduct; or
- d. violated the provisions of Municipal Code Section 2-92-610 (Living Wage Ordinance).

4. Neither the Disclosing Party, Affiliated Entity or Contractor, or any of their employees, officials, agents or partners, is barred from contracting with any unit of state or local government as a result of engaging in or being convicted of (1) bid-rigging in violation of 720 ILCS 5/33E-3; (2) bid-rotating in violation of 720 ILCS 5/33E-4; or (3) any similar offense of any state or of the United States of America that contains the same elements as the offense of bid-rigging or bid-rotating.

5. Neither the Disclosing Party nor any Affiliated Entity is listed on any of the following lists maintained by the Office of Foreign Assets Control of the U.S. Department of the Treasury or the Bureau of Industry and Security of the U.S. Department of Commerce or their successors: the Specially Designated Nationals List, the Denied Persons List, the Unverified List, the Entity List and the Debarred List.

6. The Disclosing Party understands and shall comply with the applicable requirements of Chapters 2-55 (Legislative Inspector General), 2-56 (Inspector General) and 2-156 (Governmental Ethics) of the Municipal Code.

7. If the Disclosing Party is unable to certify to any of the above statements in this Part B (Further Certifications), the Disclosing Party must explain below:

If the letters "NA," the word "None," or no response appears on the lines above, it will be conclusively presumed that the Disclosing Party certified to the above statements.

8. To the best of the Disclosing Party's knowledge after reasonable inquiry, the following is a complete list of all current employees of the Disclosing Party who were, at any time during the 12-month period preceding the execution date of this EDS, an employee, or elected or appointed official, of the City of Chicago (if none, indicate with "N/A" or "none").

NONE

9. To the best of the Disclosing Party's knowledge after reasonable inquiry, the following is a complete list of all gifts that the Disclosing Party has given or caused to be given, at any time during the 12-month period preceding the execution date of this EDS, to an employee, or elected or appointed official, of the City of Chicago. For purposes of this statement, a "gift" does not include: (i) anything made generally available to City employees or to the general public, or (ii) food or drink provided in the course of official City business and having a retail value of less than \$20 per recipient (if none, indicate with "N/A" or "none"). As to any gift listed below, please also list the name of the City recipient.

NONE

C. CERTIFICATION OF STATUS AS FINANCIAL INSTITUTION

1. The Disclosing Party certifies that the Disclosing Party (check one)

is is not

a "financial institution" as defined in Section 2-32-455(b) of the Municipal Code.

2. If the Disclosing Party IS a financial institution, then the Disclosing Party pledges:

"We are not and will not become a predatory lender as defined in Chapter 2-32 of the Municipal Code. We further pledge that none of our affiliates is, and none of them will become, a predatory lender as defined in Chapter 2-32 of the Municipal Code. We understand that becoming a predatory lender or becoming an affiliate of a predatory lender may result in the loss of the privilege of doing business with the City."

If the Disclosing Party is unable to make this pledge because it or any of its affiliates (as defined in Section 2-32-455(b) of the Municipal Code) is a predatory lender within the meaning of Chapter 2-32 of the Municipal Code, explain here (attach additional pages if necessary):

If the letters "NA," the word "None," or no response appears on the lines above, it will be conclusively presumed that the Disclosing Party certified to the above statements.

D. CERTIFICATION REGARDING INTEREST IN CITY BUSINESS

Any words or terms that are defined in Chapter 2-156 of the Municipal Code have the same meanings when used in this Part D.

1. In accordance with Section 2-156-110 of the Municipal Code: Does any official or employee of the City have a financial interest in his or her own name or in the name of any other person or entity in the Matter?

Yes No

NOTE: If you checked "Yes" to Item D.1., proceed to Items D.2. and D.3. If you checked "No" to Item D.1., proceed to Part E.

2. Unless sold pursuant to a process of competitive bidding, or otherwise permitted, no City elected official or employee shall have a financial interest in his or her own name or in the name of any other person or entity in the purchase of any property that (i) belongs to the City, or (ii) is sold for taxes or assessments, or (iii) is sold by virtue of legal process at the suit of the City (collectively, "City Property Sale"). Compensation for property taken pursuant to the City's eminent domain power does not constitute a financial interest within the meaning of this Part D.

Does the Matter involve a City Property Sale?

Yes No

3. If you checked "Yes" to Item D.1., provide the names and business addresses of the City officials or employees having such interest and identify the nature of such interest:

Name	Business Address	Nature of Interest

4. The Disclosing Party further certifies that no prohibited financial interest in the Matter will be acquired by any City official or employee.

E. CERTIFICATION REGARDING SLAVERY ERA BUSINESS

Please check either 1. or 2. below. If the Disclosing Party checks 2., the Disclosing Party must disclose below or in an attachment to this EDS all information required by paragraph 2. Failure to

comply with these disclosure requirements may make any contract entered into with the City in connection with the Matter voidable by the City.

X 1. The Disclosing Party verifies that the Disclosing Party has searched any and all records of the Disclosing Party and any and all predecessor entities regarding records of investments or profits from slavery or slaveholder insurance policies during the slavery era (including insurance policies issued to slaveholders that provided coverage for damage to or injury or death of their slaves), and the Disclosing Party has found no such records.

___ 2. The Disclosing Party verifies that, as a result of conducting the search in step 1 above, the Disclosing Party has found records of investments or profits from slavery or slaveholder insurance policies. The Disclosing Party verifies that the following constitutes full disclosure of all such records, including the names of any and all slaves or slaveholders described in those records:

SECTION VI -- CERTIFICATIONS FOR FEDERALLY FUNDED MATTERS

NOTE: If the Matter is federally funded, complete this Section VI. If the Matter is not federally funded, proceed to Section VII. For purposes of this Section VI, tax credits allocated by the City and proceeds of debt obligations of the City are not federal funding.

A. CERTIFICATION REGARDING LOBBYING

1. List below the names of all persons or entities registered under the federal Lobbying Disclosure Act of 1995 who have made lobbying contacts on behalf of the Disclosing Party with respect to the Matter: (Add sheets if necessary):

(If no explanation appears or begins on the lines above, or if the letters "NA" or if the word "None" appear, it will be conclusively presumed that the Disclosing Party means that NO persons or entities registered under the Lobbying Disclosure Act of 1995 have made lobbying contacts on behalf of the Disclosing Party with respect to the Matter.)

2. The Disclosing Party has not spent and will not expend any federally appropriated funds to pay any person or entity listed in Paragraph A.1. above for his or her lobbying activities or to pay any person or entity to influence or attempt to influence an officer or employee of any agency, as defined by applicable federal law, a member of Congress, an officer or employee of Congress, or an employee of a member of Congress, in connection with the award of any federally funded contract, making any federally funded grant or loan, entering into any cooperative agreement, or to extend, continue, renew, amend, or modify any federally funded contract, grant, loan, or cooperative agreement.

3. The Disclosing Party will submit an updated certification at the end of each calendar quarter in which there occurs any event that materially affects the accuracy of the statements and information set forth in paragraphs A.1. and A.2. above.

4. The Disclosing Party certifies that either: (i) it is not an organization described in section 501(c)(4) of the Internal Revenue Code of 1986; or (ii) it is an organization described in section 501(c)(4) of the Internal Revenue Code of 1986 but has not engaged and will not engage in "Lobbying Activities".

5. If the Disclosing Party is the Applicant, the Disclosing Party must obtain certifications equal in form and substance to paragraphs A.1. through A.4. above from all subcontractors before it awards any subcontract and the Disclosing Party must maintain all such subcontractors' certifications for the duration of the Matter and must make such certifications promptly available to the City upon request.

B. CERTIFICATION REGARDING EQUAL EMPLOYMENT OPPORTUNITY

If the Matter is federally funded, federal regulations require the Applicant and all proposed subcontractors to submit the following information with their bids or in writing at the outset of negotiations.

Is the Disclosing Party the Applicant?

Yes No

If "Yes," answer the three questions below:

1. Have you developed and do you have on file affirmative action programs pursuant to applicable federal regulations? (See 41 CFR Part 60-2.)

Yes No

2. Have you filed with the Joint Reporting Committee, the Director of the Office of Federal Contract Compliance Programs, or the Equal Employment Opportunity Commission all reports due under the applicable filing requirements?

Yes No

3. Have you participated in any previous contracts or subcontracts subject to the equal opportunity clause?

Yes No

If you checked "No" to question 1. or 2. above, please provide an explanation:

SECTION VII -- ACKNOWLEDGMENTS, CONTRACT INCORPORATION, COMPLIANCE, PENALTIES, DISCLOSURE

The Disclosing Party understands and agrees that:

A. The certifications, disclosures, and acknowledgments contained in this EDS will become part of any contract or other agreement between the Applicant and the City in connection with the Matter, whether procurement, City assistance, or other City action, and are material inducements to the City's execution of any contract or taking other action with respect to the Matter. The Disclosing Party understands that it must comply with all statutes, ordinances, and regulations on which this EDS is based.

B. The City's Governmental Ethics and Campaign Financing Ordinances, Chapters 2-156 and 2-164 of the Municipal Code, impose certain duties and obligations on persons or entities seeking City contracts, work, business, or transactions. The full text of these ordinances and a training program is available on line at www.cityofchicago.org/Ethics, and may also be obtained from the City's Board of Ethics, 740 N.

Sedgwick St., Suite 500, Chicago, IL 60610, (312) 744-9660. The Disclosing Party must comply fully with the applicable ordinances.

C. If the City determines that any information provided in this EDS is false, incomplete or inaccurate, any contract or other agreement in connection with which it is submitted may be rescinded or be void or voidable, and the City may pursue any remedies under the contract or agreement (if not rescinded or void), at law, or in equity, including terminating the Disclosing Party's participation in the Matter and/or declining to allow the Disclosing Party to participate in other transactions with the City. Remedies at law for a false statement of material fact may include incarceration and an award to the City of treble damages.

D. It is the City's policy to make this document available to the public on its Internet site and/or upon request. Some or all of the information provided on this EDS and any attachments to this EDS may be made available to the public on the Internet, in response to a Freedom of Information Act request, or otherwise. By completing and signing this EDS, the Disclosing Party waives and releases any possible rights or claims which it may have against the City in connection with the public release of information contained in this EDS and also authorizes the City to verify the accuracy of any information submitted in this EDS.

E. The information provided in this EDS must be kept current. In the event of changes, the Disclosing Party must supplement this EDS up to the time the City takes action on the Matter. If the Matter is a contract being handled by the City's Department of Procurement Services, the Disclosing Party must update this EDS as the contract requires. **NOTE:** With respect to Matters subject to Article I of Chapter 1-23 of the Municipal Code (imposing **PERMANENT INELIGIBILITY** for certain specified offenses), the information provided herein regarding eligibility must be kept current for a longer period, as required by Chapter 1-23 and Section 2-154-020 of the Municipal Code.

The Disclosing Party represents and warrants that:

F.1. The Disclosing Party is not delinquent in the payment of any tax administered by the Illinois Department of Revenue, nor are the Disclosing Party or its Affiliated Entities delinquent in paying any fine, fee, tax or other charge owed to the City. This includes, but is not limited to, all water charges, sewer charges, license fees, parking tickets, property taxes or sales taxes.

F.2 If the Disclosing Party is the Applicant, the Disclosing Party and its Affiliated Entities will not use, nor permit their subcontractors to use, any facility listed by the U.S. E.P.A. on the federal Excluded Parties List System ("EPLS") maintained by the U. S. General Services Administration.

F.3 If the Disclosing Party is the Applicant, the Disclosing Party will obtain from any contractors/subcontractors hired or to be hired in connection with the Matter certifications equal in form and substance to those in F.1. and F.2. above and will not, without the prior written consent of the City, use any such contractor/subcontractor that does not provide such certifications or that the Disclosing Party has reason to believe has not provided or cannot provide truthful certifications.

NOTE: If the Disclosing Party cannot certify as to any of the items in F.1., F.2. or F.3. above, an explanatory statement must be attached to this EDS.

CERTIFICATION

Under penalty of perjury, the person signing below: (1) warrants that he/she is authorized to execute this EDS and Appendix A (if applicable) on behalf of the Disclosing Party, and (2) warrants that all certifications and statements contained in this EDS and Appendix A (if applicable) are true, accurate and complete as of the date furnished to the City.

ICM Partners LLC

(Print or type name of Disclosing Party)

By: _____

Robin Rash
(Sign here)

Robin Rash

(Print or type name of person signing)

Manager

(Print or type title of person signing)

Signed and sworn to before me on (date) October 1, 2013
at DuPage County, Illinois (state).

Virginia M. Lunsford Notary Public.

Commission expires: 8-14-2014.

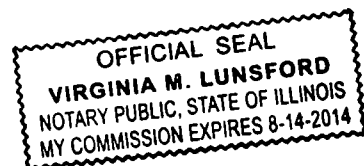

**CITY OF CHICAGO
ECONOMIC DISCLOSURE STATEMENT AND AFFIDAVIT
APPENDIX A**

FAMILIAL RELATIONSHIPS WITH ELECTED CITY OFFICIALS AND DEPARTMENT HEADS

This Appendix is to be completed only by (a) the Applicant, and (b) any legal entity which has a direct ownership interest in the Applicant exceeding 7.5 percent. It is not to be completed by any legal entity which has only an indirect ownership interest in the Applicant.

Under Municipal Code Section 2-154-015, the Disclosing Party must disclose whether such Disclosing Party or any "Applicable Party" or any Spouse or Domestic Partner thereof currently has a "familial relationship" with any elected city official or department head. A "familial relationship" exists if, as of the date this EDS is signed, the Disclosing Party or any "Applicable Party" or any Spouse or Domestic Partner thereof is related to the mayor, any alderman, the city clerk, the city treasurer or any city department head as spouse or domestic partner or as any of the following, whether by blood or adoption: parent, child, brother or sister, aunt or uncle, niece or nephew, grandparent, grandchild, father-in-law, mother-in-law, son-in-law, daughter-in-law, stepfather or stepmother, stepson or stepdaughter, stepbrother or stepsister or half-brother or half-sister.

"Applicable Party" means (1) all executive officers of the Disclosing Party listed in Section II.B.1.a., if the Disclosing Party is a corporation; all partners of the Disclosing Party, if the Disclosing Party is a general partnership; all general partners and limited partners of the Disclosing Party, if the Disclosing Party is a limited partnership; all managers, managing members and members of the Disclosing Party, if the Disclosing Party is a limited liability company; (2) all principal officers of the Disclosing Party; and (3) any person having more than a 7.5 percent ownership interest in the Disclosing Party. "Principal officers" means the president, chief operating officer, executive director, chief financial officer, treasurer or secretary of a legal entity or any person exercising similar authority.

Does the Disclosing Party or any "Applicable Party" or any Spouse or Domestic Partner thereof currently have a "familial relationship" with an elected city official or department head?

Yes

No

If yes, please identify below (1) the name and title of such person, (2) the name of the legal entity to which such person is connected; (3) the name and title of the elected city official or department head to whom such person has a familial relationship, and (4) the precise nature of such familial relationship.

**CITY OF CHICAGO
ECONOMIC DISCLOSURE STATEMENT
AND AFFIDAVIT**

SECTION I -- GENERAL INFORMATION

A. Legal name of the Disclosing Party submitting this EDS. Include d/b/a/ if applicable:

InSite Capital, L.L.C., an Illinois limited liability company

Check ONE of the following three boxes:

Indicate whether the Disclosing Party submitting this EDS is:

1. the Applicant

OR

2. a legal entity holding a direct or indirect interest in the Applicant. State the legal name of the Applicant in which the Disclosing Party holds an interest: Chicago IL (1150 Halsted) LLC

OR

3. a legal entity with a right of control (see Section II.B.1.) State the legal name of the entity in which the Disclosing Party holds a right of control: _____

B. Business address of the Disclosing Party: c/o InSite Real Estate, L.L.C.

1400 16th Street, Suite 300

Oak Brook, Illinois 60523

C. Telephone: 630/617-9100 Fax: 630/617-9120 Email: rrash@insiterealestate.com

D. Name of contact person: Robin Rash

E. Federal Employer Identification No. (if you have one): _____

F. Brief description of contract, transaction or other undertaking (referred to below as the "Matter") to which this EDS pertains. (Include project number and location of property, if applicable):

PD application for property at 1150-1168 North Halsted, Chicago, Illinois

G. Which City agency or department is requesting this EDS? DHED, Law Dept.

If the Matter is a contract being handled by the City's Department of Procurement Services, please complete the following:

Specification # _____ and Contract # _____

SECTION II -- DISCLOSURE OF OWNERSHIP INTERESTS

A. NATURE OF THE DISCLOSING PARTY

1. Indicate the nature of the Disclosing Party:

- Person
 - Publicly registered business corporation
 - Privately held business corporation
 - Sole proprietorship
 - General partnership
 - Limited partnership
 - Trust
 - Limited liability company
 - Limited liability partnership
 - Joint venture
 - Not-for-profit corporation
- (Is the not-for-profit corporation also a 501(c)(3))?
- Yes No
- Other (please specify)
-

2. For legal entities, the state (or foreign country) of incorporation or organization, if applicable:

Illinois

3. For legal entities not organized in the State of Illinois: Has the organization registered to do business in the State of Illinois as a foreign entity?

- Yes No N/A

B. IF THE DISCLOSING PARTY IS A LEGAL ENTITY:

1. List below the full names and titles of all executive officers and all directors of the entity.

NOTE: For not-for-profit corporations, also list below all members, if any, which are legal entities. If there are no such members, write "no members." For trusts, estates or other similar entities, list below the legal titleholder(s).

If the entity is a general partnership, limited partnership, limited liability company, limited liability partnership or joint venture, list below the name and title of each general partner, managing member, manager or any other person or entity that controls the day-to-day management of the Disclosing Party.

NOTE: Each legal entity listed below must submit an EDS on its own behalf.

Name	Title
Gerald J. Kostelny	Manager and Managing Director
Robin Rash	Manager
Christopher G. Hutter	Manager

2. Please provide the following information concerning each person or entity having a direct or indirect beneficial interest (including ownership) in excess of 7.5% of the Disclosing Party. Examples of such an interest include shares in a corporation, partnership interest in a partnership or joint venture,

interest of a member or manager in a limited liability company, or interest of a beneficiary of a trust, estate or other similar entity. If none, state "None." NOTE: Pursuant to Section 2-154-030 of the Municipal Code of Chicago ("Municipal Code"), the City may require any such additional information from any applicant which is reasonably intended to achieve full disclosure.

Name	Business Address	Percentage Interest in the Disclosing Party
Gerald J. Kostelny	1400 16th Street, Suite 300 Oak Brook, Illinois 60523	100%

SECTION III -- BUSINESS RELATIONSHIPS WITH CITY ELECTED OFFICIALS

Has the Disclosing Party had a "business relationship," as defined in Chapter 2-156 of the Municipal Code, with any City elected official in the 12 months before the date this EDS is signed?

Yes No

If yes, please identify below the name(s) of such City elected official(s) and describe such relationship(s):

SECTION IV -- DISCLOSURE OF SUBCONTRACTORS AND OTHER RETAINED PARTIES

The Disclosing Party must disclose the name and business address of each subcontractor, attorney, lobbyist, accountant, consultant and any other person or entity whom the Disclosing Party has retained or expects to retain in connection with the Matter, as well as the nature of the relationship, and the total amount of the fees paid or estimated to be paid. The Disclosing Party is not required to disclose employees who are paid solely through the Disclosing Party's regular payroll.

"Lobbyist" means any person or entity who undertakes to influence any legislative or administrative action on behalf of any person or entity other than: (1) a not-for-profit entity, on an unpaid basis, or (2) himself. "Lobbyist" also means any person or entity any part of whose duties as an employee of another includes undertaking to influence any legislative or administrative action.

If the Disclosing Party is uncertain whether a disclosure is required under this Section, the Disclosing Party must either ask the City whether disclosure is required or make the disclosure.

Name (indicate whether retained or anticipated to be retained)	Business Address	Relationship to Disclosing Party (subcontractor, attorney, lobbyist, etc.)	Fees (indicate whether paid or estimated.) NOTE: "hourly rate" or "t.b.d." is not an acceptable response.
--	------------------	--	--

(Add sheets if necessary)

Check here if the Disclosing Party has not retained, nor expects to retain, any such persons or entities.

SECTION V -- CERTIFICATIONS

A. COURT-ORDERED CHILD SUPPORT COMPLIANCE

Under Municipal Code Section 2-92-415, substantial owners of business entities that contract with the City must remain in compliance with their child support obligations throughout the contract's term.

Has any person who directly or indirectly owns 10% or more of the Disclosing Party been declared in arrearage on any child support obligations by any Illinois court of competent jurisdiction?

Yes No No person directly or indirectly owns 10% or more of the Disclosing Party.

If "Yes," has the person entered into a court-approved agreement for payment of all support owed and is the person in compliance with that agreement?

Yes No

B. FURTHER CERTIFICATIONS

1. Pursuant to Municipal Code Chapter 1-23, Article I ("Article I")(which the Applicant should consult for defined terms (e.g., "doing business") and legal requirements), if the Disclosing Party submitting this EDS is the Applicant and is doing business with the City, then the Disclosing Party certifies as follows: (i) neither the Applicant nor any controlling person is currently indicted or charged with, or has admitted guilt of, or has ever been convicted of, or placed under supervision for, any criminal offense involving actual, attempted, or conspiracy to commit bribery, theft, fraud, forgery, perjury, dishonesty or deceit against an officer or employee of the City or any sister agency; and (ii) the Applicant understands and acknowledges that compliance with Article I is a continuing requirement for doing business with the City. **NOTE:** If Article I applies to the Applicant, the permanent compliance timeframe in Article I supersedes some five-year compliance timeframes in certifications 2 and 3 below.

2. The Disclosing Party and, if the Disclosing Party is a legal entity, all of those persons or entities identified in Section II.B.1. of this EDS:

- a. are not presently debarred, suspended, proposed for debarment, declared ineligible or voluntarily excluded from any transactions by any federal, state or local unit of government;
- b. have not, within a five-year period preceding the date of this EDS, been convicted of a criminal offense, adjudged guilty, or had a civil judgment rendered against them in connection with: obtaining, attempting to obtain, or performing a public (federal, state or local) transaction or contract under a public transaction; a violation of federal or state antitrust statutes; fraud; embezzlement; theft; forgery; bribery; falsification or destruction of records; making false statements; or receiving stolen property;
- c. are not presently indicted for, or criminally or civilly charged by, a governmental entity (federal, state or local) with committing any of the offenses set forth in clause B.2.b. of this Section V;
- d. have not, within a five-year period preceding the date of this EDS, had one or more public transactions (federal, state or local) terminated for cause or default; and
- e. have not, within a five-year period preceding the date of this EDS, been convicted, adjudged guilty, or found liable in a civil proceeding, or in any criminal or civil action, including actions concerning environmental violations, instituted by the City or by the federal government, any state, or any other unit of local government.

3. The certifications in subparts 3, 4 and 5 concern:

- the Disclosing Party;
- any "Contractor" (meaning any contractor or subcontractor used by the Disclosing Party in connection with the Matter, including but not limited to all persons or legal entities disclosed under Section IV, "Disclosure of Subcontractors and Other Retained Parties");
- any "Affiliated Entity" (meaning a person or entity that, directly or indirectly: controls the Disclosing Party, is controlled by the Disclosing Party, or is, with the Disclosing Party, under common control of another person or entity. Indicia of control include, without limitation: interlocking management or ownership; identity of interests among family members, shared facilities and equipment; common use of employees; or organization of a business entity following the ineligibility of a business entity to do business with federal or state or local government, including the City, using substantially the same management, ownership, or principals as the ineligible entity); with respect to Contractors, the term Affiliated Entity means a person or entity that directly or indirectly controls the Contractor, is controlled by it, or, with the Contractor, is under common control of another person or entity;
- any responsible official of the Disclosing Party, any Contractor or any Affiliated Entity or any other official, agent or employee of the Disclosing Party, any Contractor or any Affiliated Entity, acting pursuant to the direction or authorization of a responsible official of the Disclosing Party, any Contractor or any Affiliated Entity (collectively "Agents").

Neither the Disclosing Party, nor any Contractor, nor any Affiliated Entity of either the Disclosing Party or any Contractor nor any Agents have, during the five years before the date this EDS is signed, or, with respect to a Contractor, an Affiliated Entity, or an Affiliated Entity of a Contractor during the five years before the date of such Contractor's or Affiliated Entity's contract or engagement in connection with the Matter:

- a. bribed or attempted to bribe, or been convicted or adjudged guilty of bribery or attempting to bribe, a public officer or employee of the City, the State of Illinois, or any agency of the federal government or of any state or local government in the United States of America, in that officer's or employee's official capacity;
- b. agreed or colluded with other bidders or prospective bidders, or been a party to any such agreement, or been convicted or adjudged guilty of agreement or collusion among bidders or prospective bidders, in restraint of freedom of competition by agreement to bid a fixed price or otherwise; or
- c. made an admission of such conduct described in a. or b. above that is a matter of record, but have not been prosecuted for such conduct; or
- d. violated the provisions of Municipal Code Section 2-92-610 (Living Wage Ordinance).

4. Neither the Disclosing Party, Affiliated Entity or Contractor, or any of their employees, officials, agents or partners, is barred from contracting with any unit of state or local government as a result of engaging in or being convicted of (1) bid-rigging in violation of 720 ILCS 5/33E-3; (2) bid-rotating in violation of 720 ILCS 5/33E-4; or (3) any similar offense of any state or of the United States of America that contains the same elements as the offense of bid-rigging or bid-rotating.

5. Neither the Disclosing Party nor any Affiliated Entity is listed on any of the following lists maintained by the Office of Foreign Assets Control of the U.S. Department of the Treasury or the Bureau of Industry and Security of the U.S. Department of Commerce or their successors: the Specially Designated Nationals List, the Denied Persons List, the Unverified List, the Entity List and the Debarred List.

6. The Disclosing Party understands and shall comply with the applicable requirements of Chapters 2-55 (Legislative Inspector General), 2-56 (Inspector General) and 2-156 (Governmental Ethics) of the Municipal Code.

7. If the Disclosing Party is unable to certify to any of the above statements in this Part B (Further Certifications), the Disclosing Party must explain below:

If the letters "NA," the word "None," or no response appears on the lines above, it will be conclusively presumed that the Disclosing Party certified to the above statements.

8. To the best of the Disclosing Party's knowledge after reasonable inquiry, the following is a complete list of all current employees of the Disclosing Party who were, at any time during the 12-month period preceding the execution date of this EDS, an employee, or elected or appointed official, of the City of Chicago (if none, indicate with "N/A" or "none").

NONE

9. To the best of the Disclosing Party's knowledge after reasonable inquiry, the following is a complete list of all gifts that the Disclosing Party has given or caused to be given, at any time during the 12-month period preceding the execution date of this EDS, to an employee, or elected or appointed official, of the City of Chicago. For purposes of this statement, a "gift" does not include: (i) anything made generally available to City employees or to the general public, or (ii) food or drink provided in the course of official City business and having a retail value of less than \$20 per recipient (if none, indicate with "N/A" or "none"). As to any gift listed below, please also list the name of the City recipient.

NONE

C. CERTIFICATION OF STATUS AS FINANCIAL INSTITUTION

1. The Disclosing Party certifies that the Disclosing Party (check one)

is is not

a "financial institution" as defined in Section 2-32-455(b) of the Municipal Code.

2. If the Disclosing Party IS a financial institution, then the Disclosing Party pledges:

"We are not and will not become a predatory lender as defined in Chapter 2-32 of the Municipal Code. We further pledge that none of our affiliates is, and none of them will become, a predatory lender as defined in Chapter 2-32 of the Municipal Code. We understand that becoming a predatory lender or becoming an affiliate of a predatory lender may result in the loss of the privilege of doing business with the City."

If the Disclosing Party is unable to make this pledge because it or any of its affiliates (as defined in Section 2-32-455(b) of the Municipal Code) is a predatory lender within the meaning of Chapter 2-32 of the Municipal Code, explain here (attach additional pages if necessary):

If the letters "NA," the word "None," or no response appears on the lines above, it will be conclusively presumed that the Disclosing Party certified to the above statements.

D. CERTIFICATION REGARDING INTEREST IN CITY BUSINESS

Any words or terms that are defined in Chapter 2-156 of the Municipal Code have the same meanings when used in this Part D.

1. In accordance with Section 2-156-110 of the Municipal Code: Does any official or employee of the City have a financial interest in his or her own name or in the name of any other person or entity in the Matter?

Yes No

NOTE: If you checked "Yes" to Item D.1., proceed to Items D.2. and D.3. If you checked "No" to Item D.1., proceed to Part E.

2. Unless sold pursuant to a process of competitive bidding, or otherwise permitted, no City elected official or employee shall have a financial interest in his or her own name or in the name of any other person or entity in the purchase of any property that (i) belongs to the City, or (ii) is sold for taxes or assessments, or (iii) is sold by virtue of legal process at the suit of the City (collectively, "City Property Sale"). Compensation for property taken pursuant to the City's eminent domain power does not constitute a financial interest within the meaning of this Part D.

Does the Matter involve a City Property Sale?

Yes No

3. If you checked "Yes" to Item D.1., provide the names and business addresses of the City officials or employees having such interest and identify the nature of such interest:

Name	Business Address	Nature of Interest
_____	_____	_____
_____	_____	_____
_____	_____	_____

4. The Disclosing Party further certifies that no prohibited financial interest in the Matter will be acquired by any City official or employee.

E. CERTIFICATION REGARDING SLAVERY ERA BUSINESS

Please check either 1. or 2. below. If the Disclosing Party checks 2., the Disclosing Party must disclose below or in an attachment to this EDS all information required by paragraph 2. Failure to

comply with these disclosure requirements may make any contract entered into with the City in connection with the Matter voidable by the City.

X 1. The Disclosing Party verifies that the Disclosing Party has searched any and all records of the Disclosing Party and any and all predecessor entities regarding records of investments or profits from slavery or slaveholder insurance policies during the slavery era (including insurance policies issued to slaveholders that provided coverage for damage to or injury or death of their slaves), and the Disclosing Party has found no such records.

___ 2. The Disclosing Party verifies that, as a result of conducting the search in step 1 above, the Disclosing Party has found records of investments or profits from slavery or slaveholder insurance policies. The Disclosing Party verifies that the following constitutes full disclosure of all such records, including the names of any and all slaves or slaveholders described in those records:

SECTION VI -- CERTIFICATIONS FOR FEDERALLY FUNDED MATTERS

NOTE: If the Matter is federally funded, complete this Section VI. If the Matter is not federally funded, proceed to Section VII. For purposes of this Section VI, tax credits allocated by the City and proceeds of debt obligations of the City are not federal funding.

A. CERTIFICATION REGARDING LOBBYING

1. List below the names of all persons or entities registered under the federal Lobbying Disclosure Act of 1995 who have made lobbying contacts on behalf of the Disclosing Party with respect to the Matter: (Add sheets if necessary):

(If no explanation appears or begins on the lines above, or if the letters "NA" or if the word "None" appear, it will be conclusively presumed that the Disclosing Party means that NO persons or entities registered under the Lobbying Disclosure Act of 1995 have made lobbying contacts on behalf of the Disclosing Party with respect to the Matter.)

2. The Disclosing Party has not spent and will not expend any federally appropriated funds to pay any person or entity listed in Paragraph A.1. above for his or her lobbying activities or to pay any person or entity to influence or attempt to influence an officer or employee of any agency, as defined by applicable federal law, a member of Congress, an officer or employee of Congress, or an employee of a member of Congress, in connection with the award of any federally funded contract, making any federally funded grant or loan, entering into any cooperative agreement, or to extend, continue, renew, amend, or modify any federally funded contract, grant, loan, or cooperative agreement.

3. The Disclosing Party will submit an updated certification at the end of each calendar quarter in which there occurs any event that materially affects the accuracy of the statements and information set forth in paragraphs A.1. and A.2. above.

4. The Disclosing Party certifies that either: (i) it is not an organization described in section 501(c)(4) of the Internal Revenue Code of 1986; or (ii) it is an organization described in section 501(c)(4) of the Internal Revenue Code of 1986 but has not engaged and will not engage in "Lobbying Activities".

5. If the Disclosing Party is the Applicant, the Disclosing Party must obtain certifications equal in form and substance to paragraphs A.1. through A.4. above from all subcontractors before it awards any subcontract and the Disclosing Party must maintain all such subcontractors' certifications for the duration of the Matter and must make such certifications promptly available to the City upon request.

B. CERTIFICATION REGARDING EQUAL EMPLOYMENT OPPORTUNITY

If the Matter is federally funded, federal regulations require the Applicant and all proposed subcontractors to submit the following information with their bids or in writing at the outset of negotiations.

Is the Disclosing Party the Applicant?

Yes No

If "Yes," answer the three questions below:

1. Have you developed and do you have on file affirmative action programs pursuant to applicable federal regulations? (See 41 CFR Part 60-2.)

Yes No

2. Have you filed with the Joint Reporting Committee, the Director of the Office of Federal Contract Compliance Programs, or the Equal Employment Opportunity Commission all reports due under the applicable filing requirements?

Yes No

3. Have you participated in any previous contracts or subcontracts subject to the equal opportunity clause?

Yes No

If you checked "No" to question 1. or 2. above, please provide an explanation:

SECTION VII -- ACKNOWLEDGMENTS, CONTRACT INCORPORATION, COMPLIANCE, PENALTIES, DISCLOSURE

The Disclosing Party understands and agrees that:

A. The certifications, disclosures, and acknowledgments contained in this EDS will become part of any contract or other agreement between the Applicant and the City in connection with the Matter, whether procurement, City assistance, or other City action, and are material inducements to the City's execution of any contract or taking other action with respect to the Matter. The Disclosing Party understands that it must comply with all statutes, ordinances, and regulations on which this EDS is based.

B. The City's Governmental Ethics and Campaign Financing Ordinances, Chapters 2-156 and 2-164 of the Municipal Code, impose certain duties and obligations on persons or entities seeking City contracts, work, business, or transactions. The full text of these ordinances and a training program is available on line at www.cityofchicago.org/Ethics, and may also be obtained from the City's Board of Ethics, 740 N.

Sedgwick St., Suite 500, Chicago, IL 60610, (312) 744-9660. The Disclosing Party must comply fully with the applicable ordinances.

C. If the City determines that any information provided in this EDS is false, incomplete or inaccurate, any contract or other agreement in connection with which it is submitted may be rescinded or be void or voidable, and the City may pursue any remedies under the contract or agreement (if not rescinded or void), at law, or in equity, including terminating the Disclosing Party's participation in the Matter and/or declining to allow the Disclosing Party to participate in other transactions with the City. Remedies at law for a false statement of material fact may include incarceration and an award to the City of treble damages.

D. It is the City's policy to make this document available to the public on its Internet site and/or upon request. Some or all of the information provided on this EDS and any attachments to this EDS may be made available to the public on the Internet, in response to a Freedom of Information Act request, or otherwise. By completing and signing this EDS, the Disclosing Party waives and releases any possible rights or claims which it may have against the City in connection with the public release of information contained in this EDS and also authorizes the City to verify the accuracy of any information submitted in this EDS.

E. The information provided in this EDS must be kept current. In the event of changes, the Disclosing Party must supplement this EDS up to the time the City takes action on the Matter. If the Matter is a contract being handled by the City's Department of Procurement Services, the Disclosing Party must update this EDS as the contract requires. **NOTE:** With respect to Matters subject to Article I of Chapter 1-23 of the Municipal Code (imposing **PERMANENT INELIGIBILITY** for certain specified offenses), the information provided herein regarding eligibility must be kept current for a longer period, as required by Chapter 1-23 and Section 2-154-020 of the Municipal Code.

The Disclosing Party represents and warrants that:

F.1. The Disclosing Party is not delinquent in the payment of any tax administered by the Illinois Department of Revenue, nor are the Disclosing Party or its Affiliated Entities delinquent in paying any fine, fee, tax or other charge owed to the City. This includes, but is not limited to, all water charges, sewer charges, license fees, parking tickets, property taxes or sales taxes.

F.2 If the Disclosing Party is the Applicant, the Disclosing Party and its Affiliated Entities will not use, nor permit their subcontractors to use, any facility listed by the U.S. E.P.A. on the federal Excluded Parties List System ("EPLS") maintained by the U. S. General Services Administration.

F.3 If the Disclosing Party is the Applicant, the Disclosing Party will obtain from any contractors/subcontractors hired or to be hired in connection with the Matter certifications equal in form and substance to those in F.1. and F.2. above and will not, without the prior written consent of the City, use any such contractor/subcontractor that does not provide such certifications or that the Disclosing Party has reason to believe has not provided or cannot provide truthful certifications.

NOTE: If the Disclosing Party cannot certify as to any of the items in F.1., F.2. or F.3. above, an explanatory statement must be attached to this EDS.

CERTIFICATION

Under penalty of perjury, the person signing below: (1) warrants that he/she is authorized to execute this EDS and Appendix A (if applicable) on behalf of the Disclosing Party, and (2) warrants that all certifications and statements contained in this EDS and Appendix A (if applicable) are true, accurate and complete as of the date furnished to the City.

InSite Capital, L.L.C.
(Print or type name of Disclosing Party)

By: *Robin Rash*
(Sign here)

Robin Rash
(Print or type name of person signing)

Manager
(Print or type title of person signing)

Signed and sworn to before me on (date) October 1, 2013,
at DuPage County, Illinois (state).

Virginia M. Lunsford Notary Public.

Commission expires: 8-14-2014.

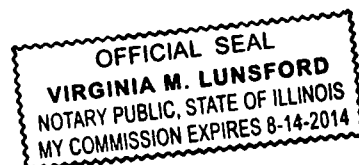

**CITY OF CHICAGO
ECONOMIC DISCLOSURE STATEMENT AND AFFIDAVIT
APPENDIX A**

FAMILIAL RELATIONSHIPS WITH ELECTED CITY OFFICIALS AND DEPARTMENT HEADS

This Appendix is to be completed only by (a) the Applicant, and (b) any legal entity which has a direct ownership interest in the Applicant exceeding 7.5 percent. It is not to be completed by any legal entity which has only an indirect ownership interest in the Applicant.

Under Municipal Code Section 2-154-015, the Disclosing Party must disclose whether such Disclosing Party or any "Applicable Party" or any Spouse or Domestic Partner thereof currently has a "familial relationship" with any elected city official or department head. A "familial relationship" exists if, as of the date this EDS is signed, the Disclosing Party or any "Applicable Party" or any Spouse or Domestic Partner thereof is related to the mayor, any alderman, the city clerk, the city treasurer or any city department head as spouse or domestic partner or as any of the following, whether by blood or adoption: parent, child, brother or sister, aunt or uncle, niece or nephew, grandparent, grandchild, father-in-law, mother-in-law, son-in-law, daughter-in-law, stepfather or stepmother, stepson or stepdaughter, stepbrother or stepsister or half-brother or half-sister.

"Applicable Party" means (1) all executive officers of the Disclosing Party listed in Section II.B.1.a., if the Disclosing Party is a corporation; all partners of the Disclosing Party, if the Disclosing Party is a general partnership; all general partners and limited partners of the Disclosing Party, if the Disclosing Party is a limited partnership; all managers, managing members and members of the Disclosing Party, if the Disclosing Party is a limited liability company; (2) all principal officers of the Disclosing Party; and (3) any person having more than a 7.5 percent ownership interest in the Disclosing Party. "Principal officers" means the president, chief operating officer, executive director, chief financial officer, treasurer or secretary of a legal entity or any person exercising similar authority.

Does the Disclosing Party or any "Applicable Party" or any Spouse or Domestic Partner thereof currently have a "familial relationship" with an elected city official or department head?

Yes

No

If yes, please identify below (1) the name and title of such person, (2) the name of the legal entity to which such person is connected; (3) the name and title of the elected city official or department head to whom such person has a familial relationship, and (4) the precise nature of such familial relationship.

**CITY OF CHICAGO
ECONOMIC DISCLOSURE STATEMENT
AND AFFIDAVIT**

SECTION I – GENERAL INFORMATION

A. Legal name of the Disclosing Party submitting this EDS. Include d/b/a/ if applicable:

Gerald J. Kostelny

Check ONE of the following three boxes:

Indicate whether the Disclosing Party submitting this EDS is:

1. the Applicant

OR

2. a legal entity holding a direct or indirect interest in the Applicant. State the legal name of the Applicant in which the Disclosing Party holds an interest: Chicago IL (1150 Halsted) LLC

OR

3. a legal entity with a right of control (see Section II.B.1.) State the legal name of the entity in which the Disclosing Party holds a right of control: _____

B. Business address of the Disclosing Party: c/o InSite Real Estate, L.L.C.

1400 16th Street, Suite 300

Oak Brook, Illinois 60523

C. Telephone: 630/617-9100 Fax: 630/617-9120 Email: gkostelny@insiterealestate.com

D. Name of contact person: Self

E. Federal Employer Identification No. (if you have one): N/A

F. Brief description of contract, transaction or other undertaking (referred to below as the "Matter") to which this EDS pertains. (Include project number and location of property, if applicable):

PD application for property at 1150-1168 North Halsted, Chicago, Illinois

G. Which City agency or department is requesting this EDS? DHED, Law Dept.

If the Matter is a contract being handled by the City's Department of Procurement Services, please complete the following:

Specification # _____ and Contract # _____

SECTION II -- DISCLOSURE OF OWNERSHIP INTERESTS

A. NATURE OF THE DISCLOSING PARTY

1. Indicate the nature of the Disclosing Party:

- Person
 - Publicly registered business corporation
 - Privately held business corporation
 - Sole proprietorship
 - General partnership
 - Limited partnership
 - Trust
 - Limited liability company
 - Limited liability partnership
 - Joint venture
 - Not-for-profit corporation
- (Is the not-for-profit corporation also a 501(c)(3))?
- Yes No
- Other (please specify) _____

2. For legal entities, the state (or foreign country) of incorporation or organization, if applicable:

3. For legal entities not organized in the State of Illinois: Has the organization registered to do business in the State of Illinois as a foreign entity?

- Yes No N/A

B. IF THE DISCLOSING PARTY IS A LEGAL ENTITY:

1. List below the full names and titles of all executive officers and all directors of the entity.

NOTE: For not-for-profit corporations, also list below all members, if any, which are legal entities. If there are no such members, write "no members." For trusts, estates or other similar entities, list below the legal titleholder(s).

If the entity is a general partnership, limited partnership, limited liability company, limited liability partnership or joint venture, list below the name and title of each general partner, managing member, manager or any other person or entity that controls the day-to-day management of the Disclosing Party.

NOTE: Each legal entity listed below must submit an EDS on its own behalf.

Name	Title
N/A	

2. Please provide the following information concerning each person or entity having a direct or indirect beneficial interest (including ownership) in excess of 7.5% of the Disclosing Party. Examples of such an interest include shares in a corporation, partnership interest in a partnership or joint venture,

interest of a member or manager in a limited liability company, or interest of a beneficiary of a trust, estate or other similar entity. If none, state "None." **NOTE:** Pursuant to Section 2-154-030 of the Municipal Code of Chicago ("Municipal Code"), the City may require any such additional information from any applicant which is reasonably intended to achieve full disclosure.

Name	Business Address	Percentage Interest in the Disclosing Party
N/A		

SECTION III -- BUSINESS RELATIONSHIPS WITH CITY ELECTED OFFICIALS

Has the Disclosing Party had a "business relationship," as defined in Chapter 2-156 of the Municipal Code, with any City elected official in the 12 months before the date this EDS is signed?

Yes No

If yes, please identify below the name(s) of such City elected official(s) and describe such relationship(s):

SECTION IV -- DISCLOSURE OF SUBCONTRACTORS AND OTHER RETAINED PARTIES

The Disclosing Party must disclose the name and business address of each subcontractor, attorney, lobbyist, accountant, consultant and any other person or entity whom the Disclosing Party has retained or expects to retain in connection with the Matter, as well as the nature of the relationship, and the total amount of the fees paid or estimated to be paid. The Disclosing Party is not required to disclose employees who are paid solely through the Disclosing Party's regular payroll.

"Lobbyist" means any person or entity who undertakes to influence any legislative or administrative action on behalf of any person or entity other than: (1) a not-for-profit entity, on an unpaid basis, or (2) himself. "Lobbyist" also means any person or entity any part of whose duties as an employee of another includes undertaking to influence any legislative or administrative action.

If the Disclosing Party is uncertain whether a disclosure is required under this Section, the Disclosing Party must either ask the City whether disclosure is required or make the disclosure.

Name (indicate whether retained or anticipated to be retained)	Business Address	Relationship to Disclosing Party (subcontractor, attorney, lobbyist, etc.)	Fees (indicate whether paid or estimated.) NOTE: "hourly rate" or "t.b.d." is not an acceptable response.
--	------------------	--	--

(Add sheets if necessary)

Check here if the Disclosing Party has not retained, nor expects to retain, any such persons or entities.

SECTION V -- CERTIFICATIONS

A. COURT-ORDERED CHILD SUPPORT COMPLIANCE

Under Municipal Code Section 2-92-415, substantial owners of business entities that contract with the City must remain in compliance with their child support obligations throughout the contract's term.

Has any person who directly or indirectly owns 10% or more of the Disclosing Party been declared in arrearage on any child support obligations by any Illinois court of competent jurisdiction?

Yes No No person directly or indirectly owns 10% or more of the Disclosing Party.

If "Yes," has the person entered into a court-approved agreement for payment of all support owed and is the person in compliance with that agreement?

Yes No

B. FURTHER CERTIFICATIONS

1. Pursuant to Municipal Code Chapter 1-23, Article I ("Article I")(which the Applicant should consult for defined terms (e.g., "doing business") and legal requirements), if the Disclosing Party submitting this EDS is the Applicant and is doing business with the City, then the Disclosing Party certifies as follows: (i) neither the Applicant nor any controlling person is currently indicted or charged with, or has admitted guilt of, or has ever been convicted of, or placed under supervision for, any criminal offense involving actual, attempted, or conspiracy to commit bribery, theft, fraud, forgery, perjury, dishonesty or deceit against an officer or employee of the City or any sister agency; and (ii) the Applicant understands and acknowledges that compliance with Article I is a continuing requirement for doing business with the City. **NOTE:** If Article I applies to the Applicant, the permanent compliance timeframe in Article I supersedes some five-year compliance timeframes in certifications 2 and 3 below.

2. The Disclosing Party and, if the Disclosing Party is a legal entity, all of those persons or entities identified in Section II.B.1. of this EDS:

- a. are not presently debarred, suspended, proposed for debarment, declared ineligible or voluntarily excluded from any transactions by any federal, state or local unit of government;
- b. have not, within a five-year period preceding the date of this EDS, been convicted of a criminal offense, adjudged guilty, or had a civil judgment rendered against them in connection with: obtaining, attempting to obtain, or performing a public (federal, state or local) transaction or contract under a public transaction; a violation of federal or state antitrust statutes; fraud; embezzlement; theft; forgery; bribery; falsification or destruction of records; making false statements; or receiving stolen property;
- c. are not presently indicted for, or criminally or civilly charged by, a governmental entity (federal, state or local) with committing any of the offenses set forth in clause B.2.b. of this Section V;
- d. have not, within a five-year period preceding the date of this EDS, had one or more public transactions (federal, state or local) terminated for cause or default; and
- e. have not, within a five-year period preceding the date of this EDS, been convicted, adjudged guilty, or found liable in a civil proceeding, or in any criminal or civil action, including actions concerning environmental violations, instituted by the City or by the federal government, any state, or any other unit of local government.

3. The certifications in subparts 3, 4 and 5 concern:

- the Disclosing Party;
- any "Contractor" (meaning any contractor or subcontractor used by the Disclosing Party in connection with the Matter, including but not limited to all persons or legal entities disclosed under Section IV, "Disclosure of Subcontractors and Other Retained Parties");
- any "Affiliated Entity" (meaning a person or entity that, directly or indirectly: controls the Disclosing Party, is controlled by the Disclosing Party, or is, with the Disclosing Party, under common control of another person or entity. Indicia of control include, without limitation: interlocking management or ownership; identity of interests among family members, shared facilities and equipment; common use of employees; or organization of a business entity following the ineligibility of a business entity to do business with federal or state or local government, including the City, using substantially the same management, ownership, or principals as the ineligible entity); with respect to Contractors, the term Affiliated Entity means a person or entity that directly or indirectly controls the Contractor, is controlled by it, or, with the Contractor, is under common control of another person or entity;
- any responsible official of the Disclosing Party, any Contractor or any Affiliated Entity or any other official, agent or employee of the Disclosing Party, any Contractor or any Affiliated Entity, acting pursuant to the direction or authorization of a responsible official of the Disclosing Party, any Contractor or any Affiliated Entity (collectively "Agents").

Neither the Disclosing Party, nor any Contractor, nor any Affiliated Entity of either the Disclosing Party or any Contractor nor any Agents have, during the five years before the date this EDS is signed, or, with respect to a Contractor, an Affiliated Entity, or an Affiliated Entity of a Contractor during the five years before the date of such Contractor's or Affiliated Entity's contract or engagement in connection with the Matter:

- a. bribed or attempted to bribe, or been convicted or adjudged guilty of bribery or attempting to bribe, a public officer or employee of the City, the State of Illinois, or any agency of the federal government or of any state or local government in the United States of America, in that officer's or employee's official capacity;
- b. agreed or colluded with other bidders or prospective bidders, or been a party to any such agreement, or been convicted or adjudged guilty of agreement or collusion among bidders or prospective bidders, in restraint of freedom of competition by agreement to bid a fixed price or otherwise; or
- c. made an admission of such conduct described in a. or b. above that is a matter of record, but have not been prosecuted for such conduct; or
- d. violated the provisions of Municipal Code Section 2-92-610 (Living Wage Ordinance).

4. Neither the Disclosing Party, Affiliated Entity or Contractor, or any of their employees, officials, agents or partners, is barred from contracting with any unit of state or local government as a result of engaging in or being convicted of (1) bid-rigging in violation of 720 ILCS 5/33E-3; (2) bid-rotating in violation of 720 ILCS 5/33E-4; or (3) any similar offense of any state or of the United States of America that contains the same elements as the offense of bid-rigging or bid-rotating.

5. Neither the Disclosing Party nor any Affiliated Entity is listed on any of the following lists maintained by the Office of Foreign Assets Control of the U.S. Department of the Treasury or the Bureau of Industry and Security of the U.S. Department of Commerce or their successors: the Specially Designated Nationals List, the Denied Persons List, the Unverified List, the Entity List and the Debarred List.

6. The Disclosing Party understands and shall comply with the applicable requirements of Chapters 2-55 (Legislative Inspector General), 2-56 (Inspector General) and 2-156 (Governmental Ethics) of the Municipal Code.

7. If the Disclosing Party is unable to certify to any of the above statements in this Part B (Further Certifications), the Disclosing Party must explain below:

If the letters "NA," the word "None," or no response appears on the lines above, it will be conclusively presumed that the Disclosing Party certified to the above statements.

8. To the best of the Disclosing Party's knowledge after reasonable inquiry, the following is a complete list of all current employees of the Disclosing Party who were, at any time during the 12-month period preceding the execution date of this EDS, an employee, or elected or appointed official, of the City of Chicago (if none, indicate with "N/A" or "none").

NONE

9. To the best of the Disclosing Party's knowledge after reasonable inquiry, the following is a complete list of all gifts that the Disclosing Party has given or caused to be given, at any time during the 12-month period preceding the execution date of this EDS, to an employee, or elected or appointed official, of the City of Chicago. For purposes of this statement, a "gift" does not include: (i) anything made generally available to City employees or to the general public, or (ii) food or drink provided in the course of official City business and having a retail value of less than \$20 per recipient (if none, indicate with "N/A" or "none"). As to any gift listed below, please also list the name of the City recipient.

NONE

C. CERTIFICATION OF STATUS AS FINANCIAL INSTITUTION

1. The Disclosing Party certifies that the Disclosing Party (check one)

is is not

a "financial institution" as defined in Section 2-32-455(b) of the Municipal Code.

2. If the Disclosing Party IS a financial institution, then the Disclosing Party pledges:

"We are not and will not become a predatory lender as defined in Chapter 2-32 of the Municipal Code. We further pledge that none of our affiliates is, and none of them will become, a predatory lender as defined in Chapter 2-32 of the Municipal Code. We understand that becoming a predatory lender or becoming an affiliate of a predatory lender may result in the loss of the privilege of doing business with the City."

If the Disclosing Party is unable to make this pledge because it or any of its affiliates (as defined in Section 2-32-455(b) of the Municipal Code) is a predatory lender within the meaning of Chapter 2-32 of the Municipal Code, explain here (attach additional pages if necessary):

If the letters "NA," the word "None," or no response appears on the lines above, it will be conclusively presumed that the Disclosing Party certified to the above statements.

D. CERTIFICATION REGARDING INTEREST IN CITY BUSINESS

Any words or terms that are defined in Chapter 2-156 of the Municipal Code have the same meanings when used in this Part D.

1. In accordance with Section 2-156-110 of the Municipal Code: Does any official or employee of the City have a financial interest in his or her own name or in the name of any other person or entity in the Matter?

Yes No

NOTE: If you checked "Yes" to Item D.1., proceed to Items D.2. and D.3. If you checked "No" to Item D.1., proceed to Part E.

2. Unless sold pursuant to a process of competitive bidding, or otherwise permitted, no City elected official or employee shall have a financial interest in his or her own name or in the name of any other person or entity in the purchase of any property that (i) belongs to the City, or (ii) is sold for taxes or assessments, or (iii) is sold by virtue of legal process at the suit of the City (collectively, "City Property Sale"). Compensation for property taken pursuant to the City's eminent domain power does not constitute a financial interest within the meaning of this Part D.

Does the Matter involve a City Property Sale?

Yes No

3. If you checked "Yes" to Item D.1., provide the names and business addresses of the City officials or employees having such interest and identify the nature of such interest:

Name	Business Address	Nature of Interest
_____	_____	_____
_____	_____	_____
_____	_____	_____

4. The Disclosing Party further certifies that no prohibited financial interest in the Matter will be acquired by any City official or employee.

E. CERTIFICATION REGARDING SLAVERY ERA BUSINESS

Please check either 1. or 2. below. If the Disclosing Party checks 2., the Disclosing Party must disclose below or in an attachment to this EDS all information required by paragraph 2. Failure to

comply with these disclosure requirements may make any contract entered into with the City in connection with the Matter voidable by the City.

X 1. The Disclosing Party verifies that the Disclosing Party has searched any and all records of the Disclosing Party and any and all predecessor entities regarding records of investments or profits from slavery or slaveholder insurance policies during the slavery era (including insurance policies issued to slaveholders that provided coverage for damage to or injury or death of their slaves), and the Disclosing Party has found no such records.

____ 2. The Disclosing Party verifies that, as a result of conducting the search in step 1 above, the Disclosing Party has found records of investments or profits from slavery or slaveholder insurance policies. The Disclosing Party verifies that the following constitutes full disclosure of all such records, including the names of any and all slaves or slaveholders described in those records:

SECTION VI -- CERTIFICATIONS FOR FEDERALLY FUNDED MATTERS

NOTE: If the Matter is federally funded, complete this Section VI. If the Matter is not federally funded, proceed to Section VII. For purposes of this Section VI, tax credits allocated by the City and proceeds of debt obligations of the City are not federal funding.

A. CERTIFICATION REGARDING LOBBYING

1. List below the names of all persons or entities registered under the federal Lobbying Disclosure Act of 1995 who have made lobbying contacts on behalf of the Disclosing Party with respect to the Matter: (Add sheets if necessary):

(If no explanation appears or begins on the lines above, or if the letters "NA" or if the word "None" appear, it will be conclusively presumed that the Disclosing Party means that NO persons or entities registered under the Lobbying Disclosure Act of 1995 have made lobbying contacts on behalf of the Disclosing Party with respect to the Matter.)

2. The Disclosing Party has not spent and will not expend any federally appropriated funds to pay any person or entity listed in Paragraph A.1. above for his or her lobbying activities or to pay any person or entity to influence or attempt to influence an officer or employee of any agency, as defined by applicable federal law, a member of Congress, an officer or employee of Congress, or an employee of a member of Congress, in connection with the award of any federally funded contract, making any federally funded grant or loan, entering into any cooperative agreement, or to extend, continue, renew, amend, or modify any federally funded contract, grant, loan, or cooperative agreement.

3. The Disclosing Party will submit an updated certification at the end of each calendar quarter in which there occurs any event that materially affects the accuracy of the statements and information set forth in paragraphs A.1. and A.2. above.

4. The Disclosing Party certifies that either: (i) it is not an organization described in section 501(c)(4) of the Internal Revenue Code of 1986; or (ii) it is an organization described in section 501(c)(4) of the Internal Revenue Code of 1986 but has not engaged and will not engage in "Lobbying Activities".

5. If the Disclosing Party is the Applicant, the Disclosing Party must obtain certifications equal in form and substance to paragraphs A.1. through A.4. above from all subcontractors before it awards any subcontract and the Disclosing Party must maintain all such subcontractors' certifications for the duration of the Matter and must make such certifications promptly available to the City upon request.

B. CERTIFICATION REGARDING EQUAL EMPLOYMENT OPPORTUNITY

If the Matter is federally funded, federal regulations require the Applicant and all proposed subcontractors to submit the following information with their bids or in writing at the outset of negotiations.

Is the Disclosing Party the Applicant?

Yes No

If "Yes," answer the three questions below:

1. Have you developed and do you have on file affirmative action programs pursuant to applicable federal regulations? (See 41 CFR Part 60-2.)

Yes No

2. Have you filed with the Joint Reporting Committee, the Director of the Office of Federal Contract Compliance Programs, or the Equal Employment Opportunity Commission all reports due under the applicable filing requirements?

Yes No

3. Have you participated in any previous contracts or subcontracts subject to the equal opportunity clause?

Yes No

If you checked "No" to question 1. or 2. above, please provide an explanation:

SECTION VII -- ACKNOWLEDGMENTS, CONTRACT INCORPORATION, COMPLIANCE, PENALTIES, DISCLOSURE

The Disclosing Party understands and agrees that:

A. The certifications, disclosures, and acknowledgments contained in this EDS will become part of any contract or other agreement between the Applicant and the City in connection with the Matter, whether procurement, City assistance, or other City action, and are material inducements to the City's execution of any contract or taking other action with respect to the Matter. The Disclosing Party understands that it must comply with all statutes, ordinances, and regulations on which this EDS is based.

B. The City's Governmental Ethics and Campaign Financing Ordinances, Chapters 2-156 and 2-164 of the Municipal Code, impose certain duties and obligations on persons or entities seeking City contracts, work, business, or transactions. The full text of these ordinances and a training program is available on line at www.cityofchicago.org/Ethics, and may also be obtained from the City's Board of Ethics, 740 N.

Sedgwick St., Suite 500, Chicago, IL 60610, (312) 744-9660. The Disclosing Party must comply fully with the applicable ordinances.

C. If the City determines that any information provided in this EDS is false, incomplete or inaccurate, any contract or other agreement in connection with which it is submitted may be rescinded or be void or voidable, and the City may pursue any remedies under the contract or agreement (if not rescinded or void), at law, or in equity, including terminating the Disclosing Party's participation in the Matter and/or declining to allow the Disclosing Party to participate in other transactions with the City. Remedies at law for a false statement of material fact may include incarceration and an award to the City of treble damages.

D. It is the City's policy to make this document available to the public on its Internet site and/or upon request. Some or all of the information provided on this EDS and any attachments to this EDS may be made available to the public on the Internet, in response to a Freedom of Information Act request, or otherwise. By completing and signing this EDS, the Disclosing Party waives and releases any possible rights or claims which it may have against the City in connection with the public release of information contained in this EDS and also authorizes the City to verify the accuracy of any information submitted in this EDS.

E. The information provided in this EDS must be kept current. In the event of changes, the Disclosing Party must supplement this EDS up to the time the City takes action on the Matter. If the Matter is a contract being handled by the City's Department of Procurement Services, the Disclosing Party must update this EDS as the contract requires. **NOTE:** With respect to Matters subject to Article I of Chapter 1-23 of the Municipal Code (imposing **PERMANENT INELIGIBILITY** for certain specified offenses), the information provided herein regarding eligibility must be kept current for a longer period, as required by Chapter 1-23 and Section 2-154-020 of the Municipal Code.

The Disclosing Party represents and warrants that:

**CITY OF CHICAGO
ECONOMIC DISCLOSURE STATEMENT AND AFFIDAVIT
APPENDIX A**

FAMILIAL RELATIONSHIPS WITH ELECTED CITY OFFICIALS AND DEPARTMENT HEADS

This Appendix is to be completed only by (a) the Applicant, and (b) any legal entity which has a direct ownership interest in the Applicant exceeding 7.5 percent. It is not to be completed by any legal entity which has only an indirect ownership interest in the Applicant.

Under Municipal Code Section 2-154-015, the Disclosing Party must disclose whether such Disclosing Party or any "Applicable Party" or any Spouse or Domestic Partner thereof currently has a "familial relationship" with any elected city official or department head. A "familial relationship" exists if, as of the date this EDS is signed, the Disclosing Party or any "Applicable Party" or any Spouse or Domestic Partner thereof is related to the mayor, any alderman, the city clerk, the city treasurer or any city department head as spouse or domestic partner or as any of the following, whether by blood or adoption: parent, child, brother or sister, aunt or uncle, niece or nephew, grandparent, grandchild, father-in-law, mother-in-law, son-in-law, daughter-in-law, stepfather or stepmother, stepson or stepdaughter, stepbrother or stepsister or half-brother or half-sister.

"Applicable Party" means (1) all executive officers of the Disclosing Party listed in Section II.B.1.a., if the Disclosing Party is a corporation; all partners of the Disclosing Party, if the Disclosing Party is a general partnership; all general partners and limited partners of the Disclosing Party, if the Disclosing Party is a limited partnership; all managers, managing members and members of the Disclosing Party, if the Disclosing Party is a limited liability company; (2) all principal officers of the Disclosing Party; and (3) any person having more than a 7.5 percent ownership interest in the Disclosing Party. "Principal officers" means the president, chief operating officer, executive director, chief financial officer, treasurer or secretary of a legal entity or any person exercising similar authority.

Does the Disclosing Party or any "Applicable Party" or any Spouse or Domestic Partner thereof currently have a "familial relationship" with an elected city official or department head?

Yes

No

If yes, please identify below (1) the name and title of such person, (2) the name of the legal entity to which such person is connected; (3) the name and title of the elected city official or department head to whom such person has a familial relationship, and (4) the precise nature of such familial relationship.

**CITY OF CHICAGO
ECONOMIC DISCLOSURE STATEMENT
AND AFFIDAVIT**

SECTION I – GENERAL INFORMATION

A. Legal name of the Disclosing Party submitting this EDS. Include d/b/a/ if applicable:

Carolyn C. Kostelny

Check ONE of the following three boxes:

Indicate whether the Disclosing Party submitting this EDS is:

1. the Applicant

OR

2. a legal entity holding a direct or indirect interest in the Applicant. State the legal name of the Applicant in which the Disclosing Party holds an interest: Chicago IL (1150 Halsted) LLC

OR

3. a legal entity with a right of control (see Section II.B.1.) State the legal name of the entity in which the Disclosing Party holds a right of control: _____

B. Business address of the Disclosing Party: c/o InSite Real Estate, L.L.C.

1400 16th Street, Suite 300

Oak Brook, Illinois 60523

C. Telephone: 630/617-9100 Fax: 630/617-9120 Email: ckostelny@insiterealestate.com

D. Name of contact person: Self

E. Federal Employer Identification No. (if you have one): N/A

F. Brief description of contract, transaction or other undertaking (referred to below as the "Matter") to which this EDS pertains. (Include project number and location of property, if applicable):

PD application for property at 1150-1168 North Halsted, Chicago, Illinois

G. Which City agency or department is requesting this EDS? DHED, Law Dept.

If the Matter is a contract being handled by the City's Department of Procurement Services, please complete the following:

Specification # _____ and Contract # _____

SECTION II -- DISCLOSURE OF OWNERSHIP INTERESTS

A. NATURE OF THE DISCLOSING PARTY

1. Indicate the nature of the Disclosing Party:

- | | |
|---|--|
| <input checked="" type="checkbox"/> Person | <input type="checkbox"/> Limited liability company |
| <input type="checkbox"/> Publicly registered business corporation | <input type="checkbox"/> Limited liability partnership |
| <input type="checkbox"/> Privately held business corporation | <input type="checkbox"/> Joint venture |
| <input type="checkbox"/> Sole proprietorship | <input type="checkbox"/> Not-for-profit corporation |
| <input type="checkbox"/> General partnership | (Is the not-for-profit corporation also a 501(c)(3))? |
| <input type="checkbox"/> Limited partnership | <input type="checkbox"/> Yes <input type="checkbox"/> No |
| <input type="checkbox"/> Trust | <input type="checkbox"/> Other (please specify) |
-

2. For legal entities, the state (or foreign country) of incorporation or organization, if applicable:

3. For legal entities not organized in the State of Illinois: Has the organization registered to do business in the State of Illinois as a foreign entity?

- Yes No N/A

B. IF THE DISCLOSING PARTY IS A LEGAL ENTITY:

1. List below the full names and titles of all executive officers and all directors of the entity.

NOTE: For not-for-profit corporations, also list below all members, if any, which are legal entities. If there are no such members, write "no members." For trusts, estates or other similar entities, list below the legal titleholder(s).

If the entity is a general partnership, limited partnership, limited liability company, limited liability partnership or joint venture, list below the name and title of each general partner, managing member, manager or any other person or entity that controls the day-to-day management of the Disclosing Party.

NOTE: Each legal entity listed below must submit an EDS on its own behalf.

Name	Title
N/A	

2. Please provide the following information concerning each person or entity having a direct or indirect beneficial interest (including ownership) in excess of 7.5% of the Disclosing Party. Examples of such an interest include shares in a corporation, partnership interest in a partnership or joint venture,

interest of a member or manager in a limited liability company, or interest of a beneficiary of a trust, estate or other similar entity. If none, state "None." **NOTE:** Pursuant to Section 2-154-030 of the Municipal Code of Chicago ("Municipal Code"), the City may require any such additional information from any applicant which is reasonably intended to achieve full disclosure.

Name	Business Address	Percentage Interest in the Disclosing Party
N/A		

SECTION III -- BUSINESS RELATIONSHIPS WITH CITY ELECTED OFFICIALS

Has the Disclosing Party had a "business relationship," as defined in Chapter 2-156 of the Municipal Code, with any City elected official in the 12 months before the date this EDS is signed?

Yes No

If yes, please identify below the name(s) of such City elected official(s) and describe such relationship(s):

SECTION IV -- DISCLOSURE OF SUBCONTRACTORS AND OTHER RETAINED PARTIES

The Disclosing Party must disclose the name and business address of each subcontractor, attorney, lobbyist, accountant, consultant and any other person or entity whom the Disclosing Party has retained or expects to retain in connection with the Matter, as well as the nature of the relationship, and the total amount of the fees paid or estimated to be paid. The Disclosing Party is not required to disclose employees who are paid solely through the Disclosing Party's regular payroll.

"Lobbyist" means any person or entity who undertakes to influence any legislative or administrative action on behalf of any person or entity other than: (1) a not-for-profit entity, on an unpaid basis, or (2) himself. "Lobbyist" also means any person or entity any part of whose duties as an employee of another includes undertaking to influence any legislative or administrative action.

If the Disclosing Party is uncertain whether a disclosure is required under this Section, the Disclosing Party must either ask the City whether disclosure is required or make the disclosure.

Name (indicate whether retained or anticipated to be retained)	Business Address	Relationship to Disclosing Party (subcontractor, attorney, lobbyist, etc.)	Fees (indicate whether paid or estimated.) NOTE: "hourly rate" or "t.b.d." is not an acceptable response.
--	------------------	--	--

(Add sheets if necessary)

Check here if the Disclosing Party has not retained, nor expects to retain, any such persons or entities.

SECTION V -- CERTIFICATIONS

A. COURT-ORDERED CHILD SUPPORT COMPLIANCE

Under Municipal Code Section 2-92-415, substantial owners of business entities that contract with the City must remain in compliance with their child support obligations throughout the contract's term.

Has any person who directly or indirectly owns 10% or more of the Disclosing Party been declared in arrearage on any child support obligations by any Illinois court of competent jurisdiction?

Yes No No person directly or indirectly owns 10% or more of the Disclosing Party.

If "Yes," has the person entered into a court-approved agreement for payment of all support owed and is the person in compliance with that agreement?

Yes No

B. FURTHER CERTIFICATIONS

1. Pursuant to Municipal Code Chapter 1-23, Article I ("Article I")(which the Applicant should consult for defined terms (e.g., "doing business") and legal requirements), if the Disclosing Party submitting this EDS is the Applicant and is doing business with the City, then the Disclosing Party certifies as follows: (i) neither the Applicant nor any controlling person is currently indicted or charged with, or has admitted guilt of, or has ever been convicted of, or placed under supervision for, any criminal offense involving actual, attempted, or conspiracy to commit bribery, theft, fraud, forgery, perjury, dishonesty or deceit against an officer or employee of the City or any sister agency; and (ii) the Applicant understands and acknowledges that compliance with Article I is a continuing requirement for doing business with the City. **NOTE:** If Article I applies to the Applicant, the permanent compliance timeframe in Article I supersedes some five-year compliance timeframes in certifications 2 and 3 below.

2. The Disclosing Party and, if the Disclosing Party is a legal entity, all of those persons or entities identified in Section II.B.1. of this EDS:

- a. are not presently debarred, suspended, proposed for debarment, declared ineligible or voluntarily excluded from any transactions by any federal, state or local unit of government;
- b. have not, within a five-year period preceding the date of this EDS, been convicted of a criminal offense, adjudged guilty, or had a civil judgment rendered against them in connection with: obtaining, attempting to obtain, or performing a public (federal, state or local) transaction or contract under a public transaction; a violation of federal or state antitrust statutes; fraud; embezzlement; theft; forgery; bribery; falsification or destruction of records; making false statements; or receiving stolen property;
- c. are not presently indicted for, or criminally or civilly charged by, a governmental entity (federal, state or local) with committing any of the offenses set forth in clause B.2.b. of this Section V;
- d. have not, within a five-year period preceding the date of this EDS, had one or more public transactions (federal, state or local) terminated for cause or default; and
- e. have not, within a five-year period preceding the date of this EDS, been convicted, adjudged guilty, or found liable in a civil proceeding, or in any criminal or civil action, including actions concerning environmental violations, instituted by the City or by the federal government, any state, or any other unit of local government.

3. The certifications in subparts 3, 4 and 5 concern:

- the Disclosing Party;
- any "Contractor" (meaning any contractor or subcontractor used by the Disclosing Party in connection with the Matter, including but not limited to all persons or legal entities disclosed under Section IV, "Disclosure of Subcontractors and Other Retained Parties");
- any "Affiliated Entity" (meaning a person or entity that, directly or indirectly: controls the Disclosing Party, is controlled by the Disclosing Party, or is, with the Disclosing Party, under common control of another person or entity. Indicia of control include, without limitation: interlocking management or ownership; identity of interests among family members, shared facilities and equipment; common use of employees; or organization of a business entity following the ineligibility of a business entity to do business with federal or state or local government, including the City, using substantially the same management, ownership, or principals as the ineligible entity); with respect to Contractors, the term Affiliated Entity means a person or entity that directly or indirectly controls the Contractor, is controlled by it, or, with the Contractor, is under common control of another person or entity;
- any responsible official of the Disclosing Party, any Contractor or any Affiliated Entity or any other official, agent or employee of the Disclosing Party, any Contractor or any Affiliated Entity, acting pursuant to the direction or authorization of a responsible official of the Disclosing Party, any Contractor or any Affiliated Entity (collectively "Agents").

Neither the Disclosing Party, nor any Contractor, nor any Affiliated Entity of either the Disclosing Party or any Contractor nor any Agents have, during the five years before the date this EDS is signed, or, with respect to a Contractor, an Affiliated Entity, or an Affiliated Entity of a Contractor during the five years before the date of such Contractor's or Affiliated Entity's contract or engagement in connection with the Matter:

- a. bribed or attempted to bribe, or been convicted or adjudged guilty of bribery or attempting to bribe, a public officer or employee of the City, the State of Illinois, or any agency of the federal government or of any state or local government in the United States of America, in that officer's or employee's official capacity;
- b. agreed or colluded with other bidders or prospective bidders, or been a party to any such agreement, or been convicted or adjudged guilty of agreement or collusion among bidders or prospective bidders, in restraint of freedom of competition by agreement to bid a fixed price or otherwise; or
- c. made an admission of such conduct described in a. or b. above that is a matter of record, but have not been prosecuted for such conduct; or
- d. violated the provisions of Municipal Code Section 2-92-610 (Living Wage Ordinance).

4. Neither the Disclosing Party, Affiliated Entity or Contractor, or any of their employees, officials, agents or partners, is barred from contracting with any unit of state or local government as a result of engaging in or being convicted of (1) bid-rigging in violation of 720 ILCS 5/33E-3; (2) bid-rotating in violation of 720 ILCS 5/33E-4; or (3) any similar offense of any state or of the United States of America that contains the same elements as the offense of bid-rigging or bid-rotating.

5. Neither the Disclosing Party nor any Affiliated Entity is listed on any of the following lists maintained by the Office of Foreign Assets Control of the U.S. Department of the Treasury or the Bureau of Industry and Security of the U.S. Department of Commerce or their successors: the Specially Designated Nationals List, the Denied Persons List, the Unverified List, the Entity List and the Debarred List.

6. The Disclosing Party understands and shall comply with the applicable requirements of Chapters 2-55 (Legislative Inspector General), 2-56 (Inspector General) and 2-156 (Governmental Ethics) of the Municipal Code.

7. If the Disclosing Party is unable to certify to any of the above statements in this Part B (Further Certifications), the Disclosing Party must explain below:

If the letters "NA," the word "None," or no response appears on the lines above, it will be conclusively presumed that the Disclosing Party certified to the above statements.

8. To the best of the Disclosing Party's knowledge after reasonable inquiry, the following is a complete list of all current employees of the Disclosing Party who were, at any time during the 12-month period preceding the execution date of this EDS, an employee, or elected or appointed official, of the City of Chicago (if none, indicate with "N/A" or "none").

NONE

9. To the best of the Disclosing Party's knowledge after reasonable inquiry, the following is a complete list of all gifts that the Disclosing Party has given or caused to be given, at any time during the 12-month period preceding the execution date of this EDS, to an employee, or elected or appointed official, of the City of Chicago. For purposes of this statement, a "gift" does not include: (i) anything made generally available to City employees or to the general public, or (ii) food or drink provided in the course of official City business and having a retail value of less than \$20 per recipient (if none, indicate with "N/A" or "none"). As to any gift listed below, please also list the name of the City recipient.

NONE

C. CERTIFICATION OF STATUS AS FINANCIAL INSTITUTION

1. The Disclosing Party certifies that the Disclosing Party (check one)

is is not

a "financial institution" as defined in Section 2-32-455(b) of the Municipal Code.

2. If the Disclosing Party IS a financial institution, then the Disclosing Party pledges:

"We are not and will not become a predatory lender as defined in Chapter 2-32 of the Municipal Code. We further pledge that none of our affiliates is, and none of them will become, a predatory lender as defined in Chapter 2-32 of the Municipal Code. We understand that becoming a predatory lender or becoming an affiliate of a predatory lender may result in the loss of the privilege of doing business with the City."

If the Disclosing Party is unable to make this pledge because it or any of its affiliates (as defined in Section 2-32-455(b) of the Municipal Code) is a predatory lender within the meaning of Chapter 2-32 of the Municipal Code, explain here (attach additional pages if necessary):

If the letters "NA," the word "None," or no response appears on the lines above, it will be conclusively presumed that the Disclosing Party certified to the above statements.

D. CERTIFICATION REGARDING INTEREST IN CITY BUSINESS

Any words or terms that are defined in Chapter 2-156 of the Municipal Code have the same meanings when used in this Part D.

1. In accordance with Section 2-156-110 of the Municipal Code: Does any official or employee of the City have a financial interest in his or her own name or in the name of any other person or entity in the Matter?

Yes No

NOTE: If you checked "Yes" to Item D.1., proceed to Items D.2. and D.3. If you checked "No" to Item D.1., proceed to Part E.

2. Unless sold pursuant to a process of competitive bidding, or otherwise permitted, no City elected official or employee shall have a financial interest in his or her own name or in the name of any other person or entity in the purchase of any property that (i) belongs to the City, or (ii) is sold for taxes or assessments, or (iii) is sold by virtue of legal process at the suit of the City (collectively, "City Property Sale"). Compensation for property taken pursuant to the City's eminent domain power does not constitute a financial interest within the meaning of this Part D.

Does the Matter involve a City Property Sale?

Yes No

3. If you checked "Yes" to Item D.1., provide the names and business addresses of the City officials or employees having such interest and identify the nature of such interest:

Name	Business Address	Nature of Interest

4. The Disclosing Party further certifies that no prohibited financial interest in the Matter will be acquired by any City official or employee.

E. CERTIFICATION REGARDING SLAVERY ERA BUSINESS

Please check either 1. or 2. below. If the Disclosing Party checks 2., the Disclosing Party must disclose below or in an attachment to this EDS all information required by paragraph 2. Failure to

comply with these disclosure requirements may make any contract entered into with the City in connection with the Matter voidable by the City.

X 1. The Disclosing Party verifies that the Disclosing Party has searched any and all records of the Disclosing Party and any and all predecessor entities regarding records of investments or profits from slavery or slaveholder insurance policies during the slavery era (including insurance policies issued to slaveholders that provided coverage for damage to or injury or death of their slaves), and the Disclosing Party has found no such records.

2. The Disclosing Party verifies that, as a result of conducting the search in step 1 above, the Disclosing Party has found records of investments or profits from slavery or slaveholder insurance policies. The Disclosing Party verifies that the following constitutes full disclosure of all such records, including the names of any and all slaves or slaveholders described in those records:

SECTION VI -- CERTIFICATIONS FOR FEDERALLY FUNDED MATTERS

NOTE: If the Matter is federally funded, complete this Section VI. If the Matter is not federally funded, proceed to Section VII. For purposes of this Section VI, tax credits allocated by the City and proceeds of debt obligations of the City are not federal funding.

A. CERTIFICATION REGARDING LOBBYING

1. List below the names of all persons or entities registered under the federal Lobbying Disclosure Act of 1995 who have made lobbying contacts on behalf of the Disclosing Party with respect to the Matter: (Add sheets if necessary):

(If no explanation appears or begins on the lines above, or if the letters "NA" or if the word "None" appear, it will be conclusively presumed that the Disclosing Party means that NO persons or entities registered under the Lobbying Disclosure Act of 1995 have made lobbying contacts on behalf of the Disclosing Party with respect to the Matter.)

2. The Disclosing Party has not spent and will not expend any federally appropriated funds to pay any person or entity listed in Paragraph A.1. above for his or her lobbying activities or to pay any person or entity to influence or attempt to influence an officer or employee of any agency, as defined by applicable federal law, a member of Congress, an officer or employee of Congress, or an employee of a member of Congress, in connection with the award of any federally funded contract, making any federally funded grant or loan, entering into any cooperative agreement, or to extend, continue, renew, amend, or modify any federally funded contract, grant, loan, or cooperative agreement.

3. The Disclosing Party will submit an updated certification at the end of each calendar quarter in which there occurs any event that materially affects the accuracy of the statements and information set forth in paragraphs A.1. and A.2. above.

4. The Disclosing Party certifies that either: (i) it is not an organization described in section 501(c)(4) of the Internal Revenue Code of 1986; or (ii) it is an organization described in section 501(c)(4) of the Internal Revenue Code of 1986 but has not engaged and will not engage in "Lobbying Activities".

5. If the Disclosing Party is the Applicant, the Disclosing Party must obtain certifications equal in form and substance to paragraphs A.1. through A.4. above from all subcontractors before it awards any subcontract and the Disclosing Party must maintain all such subcontractors' certifications for the duration of the Matter and must make such certifications promptly available to the City upon request.

B. CERTIFICATION REGARDING EQUAL EMPLOYMENT OPPORTUNITY

If the Matter is federally funded, federal regulations require the Applicant and all proposed subcontractors to submit the following information with their bids or in writing at the outset of negotiations.

Is the Disclosing Party the Applicant?

Yes No

If "Yes," answer the three questions below:

1. Have you developed and do you have on file affirmative action programs pursuant to applicable federal regulations? (See 41 CFR Part 60-2.)

Yes No

2. Have you filed with the Joint Reporting Committee, the Director of the Office of Federal Contract Compliance Programs, or the Equal Employment Opportunity Commission all reports due under the applicable filing requirements?

Yes No

3. Have you participated in any previous contracts or subcontracts subject to the equal opportunity clause?

Yes No

If you checked "No" to question 1. or 2. above, please provide an explanation:

SECTION VII -- ACKNOWLEDGMENTS, CONTRACT INCORPORATION, COMPLIANCE, PENALTIES, DISCLOSURE

The Disclosing Party understands and agrees that:

A. The certifications, disclosures, and acknowledgments contained in this EDS will become part of any contract or other agreement between the Applicant and the City in connection with the Matter, whether procurement, City assistance, or other City action, and are material inducements to the City's execution of any contract or taking other action with respect to the Matter. The Disclosing Party understands that it must comply with all statutes, ordinances, and regulations on which this EDS is based.

B. The City's Governmental Ethics and Campaign Financing Ordinances, Chapters 2-156 and 2-164 of the Municipal Code, impose certain duties and obligations on persons or entities seeking City contracts, work, business, or transactions. The full text of these ordinances and a training program is available on line at www.cityofchicago.org/Ethics, and may also be obtained from the City's Board of Ethics, 740 N.

Sedgwick St., Suite 500, Chicago, IL 60610, (312) 744-9660. The Disclosing Party must comply fully with the applicable ordinances.

C. If the City determines that any information provided in this EDS is false, incomplete or inaccurate, any contract or other agreement in connection with which it is submitted may be rescinded or be void or voidable, and the City may pursue any remedies under the contract or agreement (if not rescinded or void), at law, or in equity, including terminating the Disclosing Party's participation in the Matter and/or declining to allow the Disclosing Party to participate in other transactions with the City. Remedies at law for a false statement of material fact may include incarceration and an award to the City of treble damages.

D. It is the City's policy to make this document available to the public on its Internet site and/or upon request. Some or all of the information provided on this EDS and any attachments to this EDS may be made available to the public on the Internet, in response to a Freedom of Information Act request, or otherwise. By completing and signing this EDS, the Disclosing Party waives and releases any possible rights or claims which it may have against the City in connection with the public release of information contained in this EDS and also authorizes the City to verify the accuracy of any information submitted in this EDS.

E. The information provided in this EDS must be kept current. In the event of changes, the Disclosing Party must supplement this EDS up to the time the City takes action on the Matter. If the Matter is a contract being handled by the City's Department of Procurement Services, the Disclosing Party must update this EDS as the contract requires. **NOTE:** With respect to Matters subject to Article I of Chapter 1-23 of the Municipal Code (imposing **PERMANENT INELIGIBILITY** for certain specified offenses), the information provided herein regarding eligibility must be kept current for a longer period, as required by Chapter 1-23 and Section 2-154-020 of the Municipal Code.

The Disclosing Party represents and warrants that:

F.1. The Disclosing Party is not delinquent in the payment of any tax administered by the Illinois Department of Revenue, nor are the Disclosing Party or its Affiliated Entities delinquent in paying any fine, fee, tax or other charge owed to the City. This includes, but is not limited to, all water charges, sewer charges, license fees, parking tickets, property taxes or sales taxes.

F.2 If the Disclosing Party is the Applicant, the Disclosing Party and its Affiliated Entities will not use, nor permit their subcontractors to use, any facility listed by the U.S. E.P.A. on the federal Excluded Parties List System ("EPLS") maintained by the U. S. General Services Administration.

F.3 If the Disclosing Party is the Applicant, the Disclosing Party will obtain from any contractors/subcontractors hired or to be hired in connection with the Matter certifications equal in form and substance to those in F.1. and F.2. above and will not, without the prior written consent of the City, use any such contractor/subcontractor that does not provide such certifications or that the Disclosing Party has reason to believe has not provided or cannot provide truthful certifications.

NOTE: If the Disclosing Party cannot certify as to any of the items in F.1., F.2. or F.3. above, an explanatory statement must be attached to this EDS.

CERTIFICATION

Under penalty of perjury, the person signing below: (1) warrants that he/she is authorized to execute this EDS and Appendix A (if applicable) on behalf of the Disclosing Party, and (2) warrants that all certifications and statements contained in this EDS and Appendix A (if applicable) are true, accurate and complete as of the date furnished to the City.

Carolyn C. Kostelny

(Print or type name of Disclosing Party)

By: *Carolyn C. Kostelny*
(Sign here)

Carolyn C. Kostelny

(Print or type name of person signing)

51% Member of ICM Partners LLC

(Print or type title of person signing)

Signed and sworn to before me on (date) October 7, 2013,
at DuPage County, Illinois (state).

Virginia M. Lunsford Notary Public.

Commission expires: 8.14.2014.

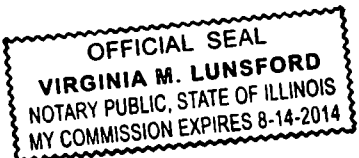

**CITY OF CHICAGO
ECONOMIC DISCLOSURE STATEMENT AND AFFIDAVIT
APPENDIX A**

FAMILIAL RELATIONSHIPS WITH ELECTED CITY OFFICIALS AND DEPARTMENT HEADS

This Appendix is to be completed only by (a) the Applicant, and (b) any legal entity which has a direct ownership interest in the Applicant exceeding 7.5 percent. It is not to be completed by any legal entity which has only an indirect ownership interest in the Applicant.

Under Municipal Code Section 2-154-015, the Disclosing Party must disclose whether such Disclosing Party or any “Applicable Party” or any Spouse or Domestic Partner thereof currently has a “familial relationship” with any elected city official or department head. A “familial relationship” exists if, as of the date this EDS is signed, the Disclosing Party or any “Applicable Party” or any Spouse or Domestic Partner thereof is related to the mayor, any alderman, the city clerk, the city treasurer or any city department head as spouse or domestic partner or as any of the following, whether by blood or adoption: parent, child, brother or sister, aunt or uncle, niece or nephew, grandparent, grandchild, father-in-law, mother-in-law, son-in-law, daughter-in-law, stepfather or stepmother, stepson or stepdaughter, stepbrother or stepsister or half-brother or half-sister.

“Applicable Party” means (1) all executive officers of the Disclosing Party listed in Section II.B.1.a., if the Disclosing Party is a corporation; all partners of the Disclosing Party, if the Disclosing Party is a general partnership; all general partners and limited partners of the Disclosing Party, if the Disclosing Party is a limited partnership; all managers, managing members and members of the Disclosing Party, if the Disclosing Party is a limited liability company; (2) all principal officers of the Disclosing Party; and (3) any person having more than a 7.5 percent ownership interest in the Disclosing Party. “Principal officers” means the president, chief operating officer, executive director, chief financial officer, treasurer or secretary of a legal entity or any person exercising similar authority.

Does the Disclosing Party or any “Applicable Party” or any Spouse or Domestic Partner thereof currently have a “familial relationship” with an elected city official or department head?

Yes

No

If yes, please identify below (1) the name and title of such person, (2) the name of the legal entity to which such person is connected; (3) the name and title of the elected city official or department head to whom such person has a familial relationship, and (4) the precise nature of such familial relationship.

October 9, 2013

Chairman, Committee on Zoning
Room 304 - City Hall
Chicago, Illinois 60602

Dear Committee Members:

I, Mary Ann Phillips, am one of the beneficiaries of the Albany Bank & Trust Co. NA as T/U/T No. 1104484, dated 10/21/87 (the "Trust"). The Trust is the legal title holder of the property located at 1150-68 North Halsted Street, Chicago, Illinois.

I understand that Katriina S. McGuire of Schain, Burney, Banks & Kenny, Ltd. has filed a sworn affidavit identifying the Trust as the owner of the land subject to the application for a planned development. I further understand that Chicago IL (1150 Halsted) LLC has been identified as the applicant of the proposed planned development. I consent to the filing of the application.



MARY ANN PHILLIPS
50% BENEFICIARY

SUBSCRIBED AND SWORN to before
me this 8th day of October, 2013

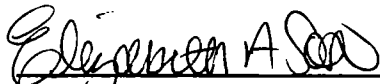

NOTARY PUBLIC



October 9, 2013

Chairman, Committee on Zoning
Room 304 - City Hall
Chicago, Illinois 60602

Dear Committee Members:

I, Barbara Vary, am one of the beneficiaries of the Albany Bank & Trust Co. NA as T/U/T No. 1104484, dated 10/21/87 (the "Trust"). The Trust is the legal title holder of the property located at 1150-68 North Halsted Street, Chicago, Illinois.

I understand that Katrina S. McGuire of Schain, Burney, Banks & Kenny, Ltd. has filed a sworn affidavit identifying the Trust as the owner of the land subject to the application for a planned development. I further understand that Chicago IL (1150 Halsted) LLC has been identified as the applicant of the proposed planned development. I consent to the filing of the application.

Barbara Vary
BARBARA VARY
50% BENEFICIARY

SUBSCRIBED AND SWORN to before
me this 7th day of Oct., 2013

[Signature]

NOTARY PUBLIC



**CITY OF CHICAGO
ECONOMIC DISCLOSURE STATEMENT
AND AFFIDAVIT**

SECTION I -- GENERAL INFORMATION

A. Legal name of the Disclosing Party submitting this EDS. Include d/b/a/ if applicable:

Albany Bank & Trust Co. NA, as T/U/T No. 11-4484, dated 10/21/87

Check ONE of the following three boxes:

Indicate whether the Disclosing Party submitting this EDS is:

1. the Applicant /Owner
OR

2. a legal entity holding a direct or indirect interest in the Applicant. State the legal name of the Applicant in which the Disclosing Party holds an interest: _____
OR

3. a legal entity with a right of control (see Section II.B.1.) State the legal name of the entity in which the Disclosing Party holds a right of control: _____

B. Business address of the Disclosing Party:

3400 West Lawrence Avenue
Chicago, IL 60625

C. Telephone: 773-267-7300

Fax: _____

Email: _____

D. Name of contact person: Brenda Helms

E. Federal Employer Identification No. (if you have one): _____

F. Brief description of contract, transaction or other undertaking (referred to below as the "Matter") to which this EDS pertains. (Include project number and location of property, if applicable):

PD application for 1150-68 North Halsted

G. Which City agency or department is requesting this EDS? DHED, Dept. of Law

If the Matter is a contract being handled by the City's Department of Procurement Services, please complete the following:

Specification # _____ and Contract # _____

SECTION II -- DISCLOSURE OF OWNERSHIP INTERESTS

A. NATURE OF THE DISCLOSING PARTY

1. Indicate the nature of the Disclosing Party:

- | | |
|---|--|
| <input type="checkbox"/> Person | <input type="checkbox"/> Limited liability company |
| <input type="checkbox"/> Publicly registered business corporation | <input type="checkbox"/> Limited liability partnership |
| <input type="checkbox"/> Privately held business corporation | <input type="checkbox"/> Joint venture |
| <input type="checkbox"/> Sole proprietorship | <input type="checkbox"/> Not-for-profit corporation |
| <input type="checkbox"/> General partnership | (Is the not-for-profit corporation also a 501(c)(3))? |
| <input type="checkbox"/> Limited partnership | <input type="checkbox"/> Yes <input type="checkbox"/> No |
| <input checked="" type="checkbox"/> Trust | <input type="checkbox"/> Other (please specify) |

2. For legal entities, the state (or foreign country) of incorporation or organization, if applicable:

3. For legal entities not organized in the State of Illinois: Has the organization registered to do business in the State of Illinois as a foreign entity?

- Yes No N/A

B. IF THE DISCLOSING PARTY IS A LEGAL ENTITY:

1. List below the full names and titles of all executive officers and all directors of the entity. **NOTE:** For not-for-profit corporations, also list below all members, if any, which are legal entities. If there are no such members, write "no members." For trusts, estates or other similar entities, list below the legal titleholder(s).

If the entity is a general partnership, limited partnership, limited liability company, limited liability partnership or joint venture, list below the name and title of each general partner, managing member, manager or any other person or entity that controls the day-to-day management of the Disclosing Party. **NOTE:** Each legal entity listed below must submit an EDS on its own behalf.

Name	Title
_____	_____
_____	_____
_____	_____
_____	_____

2. Please provide the following information concerning each person or entity having a direct or indirect beneficial interest (including ownership) in excess of 7.5% of the Disclosing Party. Examples of such an interest include shares in a corporation, partnership interest in a partnership or joint venture,

interest of a member or manager in a limited liability company, or interest of a beneficiary of a trust, estate or other similar entity. If none, state "None." **NOTE:** Pursuant to Section 2-154-030 of the Municipal Code of Chicago ("Municipal Code"), the City may require any such additional information from any applicant which is reasonably intended to achieve full disclosure.

Name	Business Address	Percentage Interest in the Disclosing Party
Mary Ann Phillips	3450 W. Ardmore Chicago IL 60659	50%
Barbara Vary	18555 Hickory Ct. Lansing IL 60438	50%

SECTION III -- BUSINESS RELATIONSHIPS WITH CITY ELECTED OFFICIALS

Has the Disclosing Party had a "business relationship," as defined in Chapter 2-156 of the Municipal Code, with any City elected official in the 12 months before the date this EDS is signed?

Yes No

If yes, please identify below the name(s) of such City elected official(s) and describe such relationship(s):

SECTION IV -- DISCLOSURE OF SUBCONTRACTORS AND OTHER RETAINED PARTIES

The Disclosing Party must disclose the name and business address of each subcontractor, attorney, lobbyist, accountant, consultant and any other person or entity whom the Disclosing Party has retained or expects to retain in connection with the Matter, as well as the nature of the relationship, and the total amount of the fees paid or estimated to be paid. The Disclosing Party is not required to disclose employees who are paid solely through the Disclosing Party's regular payroll.

"Lobbyist" means any person or entity who undertakes to influence any legislative or administrative action on behalf of any person or entity other than: (1) a not-for-profit entity, on an unpaid basis, or (2) himself. "Lobbyist" also means any person or entity any part of whose duties as an employee of another includes undertaking to influence any legislative or administrative action.

If the Disclosing Party is uncertain whether a disclosure is required under this Section, the Disclosing Party must either ask the City whether disclosure is required or make the disclosure.

Name (indicate whether retained or anticipated to be retained)	Business Address	Relationship to Disclosing Party (subcontractor, attorney, lobbyist, etc.)	Fees (indicate whether paid or estimated.) NOTE: "hourly rate" or "t.b.d." is not an acceptable response.
--	------------------	--	--

(Add sheets if necessary)

Check here if the Disclosing Party has not retained, nor expects to retain, any such persons or entities.

SECTION V -- CERTIFICATIONS

A. COURT-ORDERED CHILD SUPPORT COMPLIANCE

Under Municipal Code Section 2-92-415, substantial owners of business entities that contract with the City must remain in compliance with their child support obligations throughout the contract's term.

Has any person who directly or indirectly owns 10% or more of the Disclosing Party been declared in arrearage on any child support obligations by any Illinois court of competent jurisdiction?

Yes No No person directly or indirectly owns 10% or more of the Disclosing Party.

If "Yes," has the person entered into a court-approved agreement for payment of all support owed and is the person in compliance with that agreement?

Yes No

B. FURTHER CERTIFICATIONS

1. Pursuant to Municipal Code Chapter 1-23, Article I ("Article I")(which the Applicant should consult for defined terms (e.g., "doing business") and legal requirements), if the Disclosing Party submitting this EDS is the Applicant and is doing business with the City, then the Disclosing Party certifies as follows: (i) neither the Applicant nor any controlling person is currently indicted or charged with, or has admitted guilt of, or has ever been convicted of, or placed under supervision for, any criminal offense involving actual, attempted, or conspiracy to commit bribery, theft, fraud, forgery, perjury, dishonesty or deceit against an officer or employee of the City or any sister agency; and (ii) the Applicant understands and acknowledges that compliance with Article I is a continuing requirement for doing business with the City. **NOTE:** If Article I applies to the Applicant, the permanent compliance timeframe in Article I supersedes some five-year compliance timeframes in certifications 2 and 3 below.

2. The Disclosing Party and, if the Disclosing Party is a legal entity, all of those persons or entities identified in Section II.B.1. of this EDS:

- a. are not presently debarred, suspended, proposed for debarment, declared ineligible or voluntarily excluded from any transactions by any federal, state or local unit of government;
- b. have not, within a five-year period preceding the date of this EDS, been convicted of a criminal offense, adjudged guilty, or had a civil judgment rendered against them in connection with: obtaining, attempting to obtain, or performing a public (federal, state or local) transaction or contract under a public transaction; a violation of federal or state antitrust statutes; fraud; embezzlement; theft; forgery; bribery; falsification or destruction of records; making false statements; or receiving stolen property;
- c. are not presently indicted for, or criminally or civilly charged by, a governmental entity (federal, state or local) with committing any of the offenses set forth in clause B.2.b. of this Section V;
- d. have not, within a five-year period preceding the date of this EDS, had one or more public transactions (federal, state or local) terminated for cause or default; and
- e. have not, within a five-year period preceding the date of this EDS, been convicted, adjudged guilty, or found liable in a civil proceeding, or in any criminal or civil action, including actions concerning environmental violations, instituted by the City or by the federal government, any state, or any other unit of local government.

3. The certifications in subparts 3, 4 and 5 concern:

- the Disclosing Party;
- any "Contractor" (meaning any contractor or subcontractor used by the Disclosing Party in connection with the Matter, including but not limited to all persons or legal entities disclosed under Section IV, "Disclosure of Subcontractors and Other Retained Parties");
- any "Affiliated Entity" (meaning a person or entity that, directly or indirectly: controls the Disclosing Party, is controlled by the Disclosing Party, or is, with the Disclosing Party, under common control of another person or entity. Indicia of control include, without limitation: interlocking management or ownership; identity of interests among family members, shared facilities and equipment; common use of employees; or organization of a business entity following the ineligibility of a business entity to do business with federal or state or local government, including the City, using substantially the same management, ownership, or principals as the ineligible entity); with respect to Contractors, the term Affiliated Entity means a person or entity that directly or indirectly controls the Contractor, is controlled by it, or, with the Contractor, is under common control of another person or entity;
- any responsible official of the Disclosing Party, any Contractor or any Affiliated Entity or any other official, agent or employee of the Disclosing Party, any Contractor or any Affiliated Entity, acting pursuant to the direction or authorization of a responsible official of the Disclosing Party, any Contractor or any Affiliated Entity (collectively "Agents").

Neither the Disclosing Party, nor any Contractor, nor any Affiliated Entity of either the Disclosing Party or any Contractor nor any Agents have, during the five years before the date this EDS is signed, or, with respect to a Contractor, an Affiliated Entity, or an Affiliated Entity of a Contractor during the five years before the date of such Contractor's or Affiliated Entity's contract or engagement in connection with the Matter:

- a. bribed or attempted to bribe, or been convicted or adjudged guilty of bribery or attempting to bribe, a public officer or employee of the City, the State of Illinois, or any agency of the federal government or of any state or local government in the United States of America, in that officer's or employee's official capacity;
- b. agreed or colluded with other bidders or prospective bidders, or been a party to any such agreement, or been convicted or adjudged guilty of agreement or collusion among bidders or prospective bidders, in restraint of freedom of competition by agreement to bid a fixed price or otherwise; or
- c. made an admission of such conduct described in a. or b. above that is a matter of record, but have not been prosecuted for such conduct; or
- d. violated the provisions of Municipal Code Section 2-92-610 (Living Wage Ordinance).

4. Neither the Disclosing Party, Affiliated Entity or Contractor, or any of their employees, officials, agents or partners, is barred from contracting with any unit of state or local government as a result of engaging in or being convicted of (1) bid-rigging in violation of 720 ILCS 5/33E-3; (2) bid-rotating in violation of 720 ILCS 5/33E-4; or (3) any similar offense of any state or of the United States of America that contains the same elements as the offense of bid-rigging or bid-rotating.

5. Neither the Disclosing Party nor any Affiliated Entity is listed on any of the following lists maintained by the Office of Foreign Assets Control of the U.S. Department of the Treasury or the Bureau of Industry and Security of the U.S. Department of Commerce or their successors: the Specially Designated Nationals List, the Denied Persons List, the Unverified List, the Entity List and the Debarred List.

6. The Disclosing Party understands and shall comply with the applicable requirements of Chapters 2-55 (Legislative Inspector General), 2-56 (Inspector General) and 2-156 (Governmental Ethics) of the Municipal Code.

7. If the Disclosing Party is unable to certify to any of the above statements in this Part B (Further Certifications), the Disclosing Party must explain below:

If the letters "NA," the word "None," or no response appears on the lines above, it will be conclusively presumed that the Disclosing Party certified to the above statements.

8. To the best of the Disclosing Party's knowledge after reasonable inquiry, the following is a complete list of all current employees of the Disclosing Party who were, at any time during the 12-month period preceding the execution date of this EDS, an employee, or elected or appointed official, of the City of Chicago (if none, indicate with "N/A" or "none").

N/A

9. To the best of the Disclosing Party's knowledge after reasonable inquiry, the following is a complete list of all gifts that the Disclosing Party has given or caused to be given, at any time during the 12-month period preceding the execution date of this EDS, to an employee, or elected or appointed official, of the City of Chicago. For purposes of this statement, a "gift" does not include: (i) anything made generally available to City employees or to the general public, or (ii) food or drink provided in the course of official City business and having a retail value of less than \$20 per recipient (if none, indicate with "N/A" or "none"). As to any gift listed below, please also list the name of the City recipient.

N/A

C. CERTIFICATION OF STATUS AS FINANCIAL INSTITUTION

1. The Disclosing Party certifies that the Disclosing Party (check one)

is is not

a "financial institution" as defined in Section 2-32-455(b) of the Municipal Code.

2. If the Disclosing Party IS a financial institution, then the Disclosing Party pledges:

"We are not and will not become a predatory lender as defined in Chapter 2-32 of the Municipal Code. We further pledge that none of our affiliates is, and none of them will become, a predatory lender as defined in Chapter 2-32 of the Municipal Code. We understand that becoming a predatory lender or becoming an affiliate of a predatory lender may result in the loss of the privilege of doing business with the City."

If the Disclosing Party is unable to make this pledge because it or any of its affiliates (as defined in Section 2-32-455(b) of the Municipal Code) is a predatory lender within the meaning of Chapter 2-32 of the Municipal Code, explain here (attach additional pages if necessary):

If the letters "NA," the word "None," or no response appears on the lines above, it will be conclusively presumed that the Disclosing Party certified to the above statements.

D. CERTIFICATION REGARDING INTEREST IN CITY BUSINESS

Any words or terms that are defined in Chapter 2-156 of the Municipal Code have the same meanings when used in this Part D.

1. In accordance with Section 2-156-110 of the Municipal Code: Does any official or employee of the City have a financial interest in his or her own name or in the name of any other person or entity in the Matter?

Yes No

NOTE: If you checked "Yes" to Item D.1., proceed to Items D.2. and D.3. If you checked "No" to Item D.1., proceed to Part E.

2. Unless sold pursuant to a process of competitive bidding, or otherwise permitted, no City elected official or employee shall have a financial interest in his or her own name or in the name of any other person or entity in the purchase of any property that (i) belongs to the City, or (ii) is sold for taxes or assessments, or (iii) is sold by virtue of legal process at the suit of the City (collectively, "City Property Sale"). Compensation for property taken pursuant to the City's eminent domain power does not constitute a financial interest within the meaning of this Part D.

Does the Matter involve a City Property Sale?

Yes No

3. If you checked "Yes" to Item D.1., provide the names and business addresses of the City officials or employees having such interest and identify the nature of such interest:

Name	Business Address	Nature of Interest

4. The Disclosing Party further certifies that no prohibited financial interest in the Matter will be acquired by any City official or employee.

E. CERTIFICATION REGARDING SLAVERY ERA BUSINESS

Please check either 1. or 2. below. If the Disclosing Party checks 2., the Disclosing Party must disclose below or in an attachment to this EDS all information required by paragraph 2. Failure to

comply with these disclosure requirements may make any contract entered into with the City in connection with the Matter voidable by the City.

 X 1. The Disclosing Party verifies that the Disclosing Party has searched any and all records of the Disclosing Party and any and all predecessor entities regarding records of investments or profits from slavery or slaveholder insurance policies during the slavery era (including insurance policies issued to slaveholders that provided coverage for damage to or injury or death of their slaves), and the Disclosing Party has found no such records.

 2. The Disclosing Party verifies that, as a result of conducting the search in step 1 above, the Disclosing Party has found records of investments or profits from slavery or slaveholder insurance policies. The Disclosing Party verifies that the following constitutes full disclosure of all such records, including the names of any and all slaves or slaveholders described in those records:

SECTION VI -- CERTIFICATIONS FOR FEDERALLY FUNDED MATTERS

NOTE: If the Matter is federally funded, complete this Section VI. If the Matter is not federally funded, proceed to Section VII. For purposes of this Section VI, tax credits allocated by the City and proceeds of debt obligations of the City are not federal funding.

A. CERTIFICATION REGARDING LOBBYING

1. List below the names of all persons or entities registered under the federal Lobbying Disclosure Act of 1995 who have made lobbying contacts on behalf of the Disclosing Party with respect to the Matter: (Add sheets if necessary):

(If no explanation appears or begins on the lines above, or if the letters "NA" or if the word "None" appear, it will be conclusively presumed that the Disclosing Party means that NO persons or entities registered under the Lobbying Disclosure Act of 1995 have made lobbying contacts on behalf of the Disclosing Party with respect to the Matter.)

2. The Disclosing Party has not spent and will not expend any federally appropriated funds to pay any person or entity listed in Paragraph A.1. above for his or her lobbying activities or to pay any person or entity to influence or attempt to influence an officer or employee of any agency, as defined by applicable federal law, a member of Congress, an officer or employee of Congress, or an employee of a member of Congress, in connection with the award of any federally funded contract, making any federally funded grant or loan, entering into any cooperative agreement, or to extend, continue, renew, amend, or modify any federally funded contract, grant, loan, or cooperative agreement.

3. The Disclosing Party will submit an updated certification at the end of each calendar quarter in which there occurs any event that materially affects the accuracy of the statements and information set forth in paragraphs A.1. and A.2. above.

4. The Disclosing Party certifies that either: (i) it is not an organization described in section 501(c)(4) of the Internal Revenue Code of 1986; or (ii) it is an organization described in section 501(c)(4) of the Internal Revenue Code of 1986 but has not engaged and will not engage in "Lobbying Activities".

5. If the Disclosing Party is the Applicant, the Disclosing Party must obtain certifications equal in form and substance to paragraphs A.1. through A.4. above from all subcontractors before it awards any subcontract and the Disclosing Party must maintain all such subcontractors' certifications for the duration of the Matter and must make such certifications promptly available to the City upon request.

B. CERTIFICATION REGARDING EQUAL EMPLOYMENT OPPORTUNITY

If the Matter is federally funded, federal regulations require the Applicant and all proposed subcontractors to submit the following information with their bids or in writing at the outset of negotiations.

Is the Disclosing Party the Applicant?

Yes No

If "Yes," answer the three questions below:

1. Have you developed and do you have on file affirmative action programs pursuant to applicable federal regulations? (See 41 CFR Part 60-2.)

Yes No

2. Have you filed with the Joint Reporting Committee, the Director of the Office of Federal Contract Compliance Programs, or the Equal Employment Opportunity Commission all reports due under the applicable filing requirements?

Yes No

3. Have you participated in any previous contracts or subcontracts subject to the equal opportunity clause?

Yes No

If you checked "No" to question 1. or 2. above, please provide an explanation:

SECTION VII -- ACKNOWLEDGMENTS, CONTRACT INCORPORATION, COMPLIANCE, PENALTIES, DISCLOSURE

The Disclosing Party understands and agrees that:

A. The certifications, disclosures, and acknowledgments contained in this EDS will become part of any contract or other agreement between the Applicant and the City in connection with the Matter, whether procurement, City assistance, or other City action, and are material inducements to the City's execution of any contract or taking other action with respect to the Matter. The Disclosing Party understands that it must comply with all statutes, ordinances, and regulations on which this EDS is based.

B. The City's Governmental Ethics and Campaign Financing Ordinances, Chapters 2-156 and 2-164 of the Municipal Code, impose certain duties and obligations on persons or entities seeking City contracts, work, business, or transactions. The full text of these ordinances and a training program is available on line at www.cityofchicago.org/Ethics, and may also be obtained from the City's Board of Ethics, 740 N.

Sedgwick St., Suite 500, Chicago, IL 60610, (312) 744-9660. The Disclosing Party must comply fully with the applicable ordinances.

C. If the City determines that any information provided in this EDS is false, incomplete or inaccurate, any contract or other agreement in connection with which it is submitted may be rescinded or be void or voidable, and the City may pursue any remedies under the contract or agreement (if not rescinded or void), at law, or in equity, including terminating the Disclosing Party's participation in the Matter and/or declining to allow the Disclosing Party to participate in other transactions with the City. Remedies at law for a false statement of material fact may include incarceration and an award to the City of treble damages.

D. It is the City's policy to make this document available to the public on its Internet site and/or upon request. Some or all of the information provided on this EDS and any attachments to this EDS may be made available to the public on the Internet, in response to a Freedom of Information Act request, or otherwise. By completing and signing this EDS, the Disclosing Party waives and releases any possible rights or claims which it may have against the City in connection with the public release of information contained in this EDS and also authorizes the City to verify the accuracy of any information submitted in this EDS.

E. The information provided in this EDS must be kept current. In the event of changes, the Disclosing Party must supplement this EDS up to the time the City takes action on the Matter. If the Matter is a contract being handled by the City's Department of Procurement Services, the Disclosing Party must update this EDS as the contract requires. **NOTE:** With respect to Matters subject to Article I of Chapter 1-23 of the Municipal Code (imposing **PERMANENT INELIGIBILITY** for certain specified offenses), the information provided herein regarding eligibility must be kept current for a longer period, as required by Chapter 1-23 and Section 2-154-020 of the Municipal Code.

The Disclosing Party represents and warrants that:

F.1. The Disclosing Party is not delinquent in the payment of any tax administered by the Illinois Department of Revenue, nor are the Disclosing Party or its Affiliated Entities delinquent in paying any fine, fee, tax or other charge owed to the City. This includes, but is not limited to, all water charges, sewer charges, license fees, parking tickets, property taxes or sales taxes, other than real property taxes with respect to the subject property for which estimates of redemption have been ordered and which taxes are intended to be paid in full at the time of closing of the sale of the subject property which is anticipated to be on October 31, 2013.

F.2 If the Disclosing Party is the Applicant, the Disclosing Party and its Affiliated Entities will not use, nor permit their subcontractors to use, any facility listed by the U.S. E.P.A. on the federal Excluded Parties List System ("EPLS") maintained by the U. S. General Services Administration.

F.3 If the Disclosing Party is the Applicant, the Disclosing Party will obtain from any contractors/subcontractors hired or to be hired in connection with the Matter certifications equal in form and substance to those in F.1. and F.2. above and will not, without the prior written consent of the City, use any such contractor/subcontractor that does not provide such certifications or that the Disclosing Party has reason to believe has not provided or cannot provide truthful certifications.

NOTE: If the Disclosing Party cannot certify as to any of the items in F.1., F.2. or F.3. above, an explanatory statement must be attached to this EDS.

CERTIFICATION

Under penalty of perjury, the person signing below: (1) warrants that he/she is authorized to execute this EDS and Appendix A (if applicable) on behalf of the Disclosing Party, and (2) warrants that all certifications and statements contained in this EDS and Appendix A (if applicable) are true, accurate and complete as of the date furnished to the City.

Albany Bank & Trust Co. NA as T/U/T #11-4484, dated 10/21/87

(Print or type name of Disclosing Party)

By: [Signature]
(Sign here)

MARY ANN PHILLIPS
(Print or type name of person signing)

A Beneficiary
(Print or type title of person signing)

Signed and sworn to before me on (date) October 8, 2013,
at Cook County, IL (state).

[Signature] Notary Public.

Commission expires: 10/21/10.

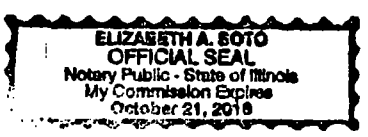

1. The first part of the document is a list of names and titles, including the names of the authors and the titles of their respective works. This list is organized in a structured manner, likely serving as a table of contents or a reference list for the document.

**CITY OF CHICAGO
ECONOMIC DISCLOSURE STATEMENT AND AFFIDAVIT
APPENDIX A**

FAMILIAL RELATIONSHIPS WITH ELECTED CITY OFFICIALS AND DEPARTMENT HEADS

This Appendix is to be completed only by (a) the Applicant, and (b) any legal entity which has a direct ownership interest in the Applicant exceeding 7.5 percent. It is not to be completed by any legal entity which has only an indirect ownership interest in the Applicant.

Under Municipal Code Section 2-154-015, the Disclosing Party must disclose whether such Disclosing Party or any "Applicable Party" or any Spouse or Domestic Partner thereof currently has a "familial relationship" with any elected city official or department head. A "familial relationship" exists if, as of the date this EDS is signed, the Disclosing Party or any "Applicable Party" or any Spouse or Domestic Partner thereof is related to the mayor, any alderman, the city clerk, the city treasurer or any city department head as spouse or domestic partner or as any of the following, whether by blood or adoption: parent, child, brother or sister, aunt or uncle, niece or nephew, grandparent, grandchild, father-in-law, mother-in-law, son-in-law, daughter-in-law, stepfather or stepmother, stepson or stepdaughter, stepbrother or stepsister or half-brother or half-sister.

"Applicable Party" means (1) all executive officers of the Disclosing Party listed in Section II.B.1.a., if the Disclosing Party is a corporation; all partners of the Disclosing Party, if the Disclosing Party is a general partnership; all general partners and limited partners of the Disclosing Party, if the Disclosing Party is a limited partnership; all managers, managing members and members of the Disclosing Party, if the Disclosing Party is a limited liability company; (2) all principal officers of the Disclosing Party; and (3) any person having more than a 7.5 percent ownership interest in the Disclosing Party. "Principal officers" means the president, chief operating officer, executive director, chief financial officer, treasurer or secretary of a legal entity or any person exercising similar authority.

Does the Disclosing Party or any "Applicable Party" or any Spouse or Domestic Partner thereof currently have a "familial relationship" with an elected city official or department head?

Yes

No

If yes, please identify below (1) the name and title of such person, (2) the name of the legal entity to which such person is connected; (3) the name and title of the elected city official or department head to whom such person has a familial relationship, and (4) the precise nature of such familial relationship.

SECTION II -- DISCLOSURE OF OWNERSHIP INTERESTS

A. NATURE OF THE DISCLOSING PARTY

1. Indicate the nature of the Disclosing Party:

- Person
- Publicly registered business corporation
- Privately held business corporation
- Sole proprietorship
- General partnership
- Limited partnership
- Trust
- Limited liability company
- Limited liability partnership
- Joint venture
- Not-for-profit corporation
(Is the not-for-profit corporation also a 501(c)(3))?
 Yes No
- Other (please specify)

2. For legal entities, the state (or foreign country) of incorporation or organization, if applicable:

3. For legal entities not organized in the State of Illinois: Has the organization registered to do business in the State of Illinois as a foreign entity?

- Yes No N/A

B. IF THE DISCLOSING PARTY IS A LEGAL ENTITY:

1. List below the full names and titles of all executive officers and all directors of the entity. **NOTE:** For not-for-profit corporations, also list below all members, if any, which are legal entities. If there are no such members, write "no members." For trusts, estates or other similar entities, list below the legal titleholder(s).

If the entity is a general partnership, limited partnership, limited liability company, limited liability partnership or joint venture, list below the name and title of each general partner, managing member, manager or any other person or entity that controls the day-to-day management of the Disclosing Party. **NOTE:** Each legal entity listed below must submit an EDS on its own behalf.

Name	Title
N/A	

2. Please provide the following information concerning each person or entity having a direct or indirect beneficial interest (including ownership) in excess of 7.5% of the Disclosing Party. Examples of such an interest include shares in a corporation, partnership interest in a partnership or joint venture,

interest of a member or manager in a limited liability company, or interest of a beneficiary of a trust, estate or other similar entity. If none, state "None." **NOTE:** Pursuant to Section 2-154-030 of the Municipal Code of Chicago ("Municipal Code"), the City may require any such additional information from any applicant which is reasonably intended to achieve full disclosure.

Name	Business Address	Percentage Interest in the Disclosing Party
<hr/>		
<hr/>		
<hr/>		

SECTION III -- BUSINESS RELATIONSHIPS WITH CITY ELECTED OFFICIALS

Has the Disclosing Party had a "business relationship," as defined in Chapter 2-156 of the Municipal Code, with any City elected official in the 12 months before the date this EDS is signed?

Yes No

If yes, please identify below the name(s) of such City elected official(s) and describe such relationship(s):

SECTION IV -- DISCLOSURE OF SUBCONTRACTORS AND OTHER RETAINED PARTIES

The Disclosing Party must disclose the name and business address of each subcontractor, attorney, lobbyist, accountant, consultant and any other person or entity whom the Disclosing Party has retained or expects to retain in connection with the Matter, as well as the nature of the relationship, and the total amount of the fees paid or estimated to be paid. The Disclosing Party is not required to disclose employees who are paid solely through the Disclosing Party's regular payroll.

"Lobbyist" means any person or entity who undertakes to influence any legislative or administrative action on behalf of any person or entity other than: (1) a not-for-profit entity, on an unpaid basis, or (2) himself. "Lobbyist" also means any person or entity any part of whose duties as an employee of another includes undertaking to influence any legislative or administrative action.

If the Disclosing Party is uncertain whether a disclosure is required under this Section, the Disclosing Party must either ask the City whether disclosure is required or make the disclosure.

Name (indicate whether retained or anticipated to be retained)	Business Address	Relationship to Disclosing Party (subcontractor, attorney, lobbyist, etc.)	Fees (indicate whether paid or estimated.) NOTE: "hourly rate" or "t.b.d." is not an acceptable response.
--	------------------	--	--

(Add sheets if necessary)

Check here if the Disclosing Party has not retained, nor expects to retain, any such persons or entities.

SECTION V -- CERTIFICATIONS

A. COURT-ORDERED CHILD SUPPORT COMPLIANCE

Under Municipal Code Section 2-92-415, substantial owners of business entities that contract with the City must remain in compliance with their child support obligations throughout the contract's term.

Has any person who directly or indirectly owns 10% or more of the Disclosing Party been declared in arrearage on any child support obligations by any Illinois court of competent jurisdiction?

Yes No No person directly or indirectly owns 10% or more of the Disclosing Party.

If "Yes," has the person entered into a court-approved agreement for payment of all support owed and is the person in compliance with that agreement?

Yes No

B. FURTHER CERTIFICATIONS

1. Pursuant to Municipal Code Chapter 1-23, Article I ("Article I")(which the Applicant should consult for defined terms (e.g., "doing business") and legal requirements), if the Disclosing Party submitting this EDS is the Applicant and is doing business with the City, then the Disclosing Party certifies as follows: (i) neither the Applicant nor any controlling person is currently indicted or charged with, or has admitted guilt of, or has ever been convicted of, or placed under supervision for, any criminal offense involving actual, attempted, or conspiracy to commit bribery, theft, fraud, forgery, perjury, dishonesty or deceit against an officer or employee of the City or any sister agency; and (ii) the Applicant understands and acknowledges that compliance with Article I is a continuing requirement for doing business with the City. **NOTE:** If Article I applies to the Applicant, the permanent compliance timeframe in Article I supersedes some five-year compliance timeframes in certifications 2 and 3 below.

2. The Disclosing Party and, if the Disclosing Party is a legal entity, all of those persons or entities identified in Section II.B.1. of this EDS:

- a. are not presently debarred, suspended, proposed for debarment, declared ineligible or voluntarily excluded from any transactions by any federal, state or local unit of government;
- b. have not, within a five-year period preceding the date of this EDS, been convicted of a criminal offense, adjudged guilty, or had a civil judgment rendered against them in connection with: obtaining, attempting to obtain, or performing a public (federal, state or local) transaction or contract under a public transaction; a violation of federal or state antitrust statutes; fraud; embezzlement; theft; forgery; bribery; falsification or destruction of records; making false statements; or receiving stolen property;
- c. are not presently indicted for, or criminally or civilly charged by, a governmental entity (federal, state or local) with committing any of the offenses set forth in clause B.2.b. of this Section V;
- d. have not, within a five-year period preceding the date of this EDS, had one or more public transactions (federal, state or local) terminated for cause or default; and
- e. have not, within a five-year period preceding the date of this EDS, been convicted, adjudged guilty, or found liable in a civil proceeding, or in any criminal or civil action, including actions concerning environmental violations, instituted by the City or by the federal government, any state, or any other unit of local government.

3. The certifications in subparts 3, 4 and 5 concern:

- the Disclosing Party;
- any "Contractor" (meaning any contractor or subcontractor used by the Disclosing Party in connection with the Matter, including but not limited to all persons or legal entities disclosed under Section IV, "Disclosure of Subcontractors and Other Retained Parties");
- any "Affiliated Entity" (meaning a person or entity that, directly or indirectly: controls the Disclosing Party, is controlled by the Disclosing Party, or is, with the Disclosing Party, under common control of another person or entity. Indicia of control include, without limitation: interlocking management or ownership; identity of interests among family members, shared facilities and equipment; common use of employees; or organization of a business entity following the ineligibility of a business entity to do business with federal or state or local government, including the City, using substantially the same management, ownership, or principals as the ineligible entity); with respect to Contractors, the term Affiliated Entity means a person or entity that directly or indirectly controls the Contractor, is controlled by it, or, with the Contractor, is under common control of another person or entity;
- any responsible official of the Disclosing Party, any Contractor or any Affiliated Entity or any other official, agent or employee of the Disclosing Party, any Contractor or any Affiliated Entity, acting pursuant to the direction or authorization of a responsible official of the Disclosing Party, any Contractor or any Affiliated Entity (collectively "Agents").

Neither the Disclosing Party, nor any Contractor, nor any Affiliated Entity of either the Disclosing Party or any Contractor nor any Agents have, during the five years before the date this EDS is signed, or, with respect to a Contractor, an Affiliated Entity, or an Affiliated Entity of a Contractor during the five years before the date of such Contractor's or Affiliated Entity's contract or engagement in connection with the Matter:

- a. bribed or attempted to bribe, or been convicted or adjudged guilty of bribery or attempting to bribe, a public officer or employee of the City, the State of Illinois, or any agency of the federal government or of any state or local government in the United States of America, in that officer's or employee's official capacity;
- b. agreed or colluded with other bidders or prospective bidders, or been a party to any such agreement, or been convicted or adjudged guilty of agreement or collusion among bidders or prospective bidders, in restraint of freedom of competition by agreement to bid a fixed price or otherwise; or
- c. made an admission of such conduct described in a. or b. above that is a matter of record, but have not been prosecuted for such conduct; or
- d. violated the provisions of Municipal Code Section 2-92-610 (Living Wage Ordinance).

4. Neither the Disclosing Party, Affiliated Entity or Contractor, or any of their employees, officials, agents or partners, is barred from contracting with any unit of state or local government as a result of engaging in or being convicted of (1) bid-rigging in violation of 720 ILCS 5/33E-3; (2) bid-rotating in violation of 720 ILCS 5/33E-4; or (3) any similar offense of any state or of the United States of America that contains the same elements as the offense of bid-rigging or bid-rotating.

5. Neither the Disclosing Party nor any Affiliated Entity is listed on any of the following lists maintained by the Office of Foreign Assets Control of the U.S. Department of the Treasury or the Bureau of Industry and Security of the U.S. Department of Commerce or their successors: the Specially Designated Nationals List, the Denied Persons List, the Unverified List, the Entity List and the Debarred List.

6. The Disclosing Party understands and shall comply with the applicable requirements of Chapters 2-55 (Legislative Inspector General), 2-56 (Inspector General) and 2-156 (Governmental Ethics) of the Municipal Code.

7. If the Disclosing Party is unable to certify to any of the above statements in this Part B (Further Certifications), the Disclosing Party must explain below:

If the letters "NA," the word "None," or no response appears on the lines above, it will be conclusively presumed that the Disclosing Party certified to the above statements.

8. To the best of the Disclosing Party's knowledge after reasonable inquiry, the following is a complete list of all current employees of the Disclosing Party who were, at any time during the 12-month period preceding the execution date of this EDS, an employee, or elected or appointed official, of the City of Chicago (if none, indicate with "N/A" or "none").
N/A

9. To the best of the Disclosing Party's knowledge after reasonable inquiry, the following is a complete list of all gifts that the Disclosing Party has given or caused to be given, at any time during the 12-month period preceding the execution date of this EDS, to an employee, or elected or appointed official, of the City of Chicago. For purposes of this statement, a "gift" does not include: (i) anything made generally available to City employees or to the general public, or (ii) food or drink provided in the course of official City business and having a retail value of less than \$20 per recipient (if none, indicate with "N/A" or "none"). As to any gift listed below, please also list the name of the City recipient.
N/A

C. CERTIFICATION OF STATUS AS FINANCIAL INSTITUTION

1. The Disclosing Party certifies that the Disclosing Party (check one)

is is not

a "financial institution" as defined in Section 2-32-455(b) of the Municipal Code.

2. If the Disclosing Party IS a financial institution, then the Disclosing Party pledges:

"We are not and will not become a predatory lender as defined in Chapter 2-32 of the Municipal Code. We further pledge that none of our affiliates is, and none of them will become, a predatory lender as defined in Chapter 2-32 of the Municipal Code. We understand that becoming a predatory lender or becoming an affiliate of a predatory lender may result in the loss of the privilege of doing business with the City."

If the Disclosing Party is unable to make this pledge because it or any of its affiliates (as defined in Section 2-32-455(b) of the Municipal Code) is a predatory lender within the meaning of Chapter 2-32 of the Municipal Code, explain here (attach additional pages if necessary):

If the letters "NA," the word "None," or no response appears on the lines above, it will be conclusively presumed that the Disclosing Party certified to the above statements.

D. CERTIFICATION REGARDING INTEREST IN CITY BUSINESS

Any words or terms that are defined in Chapter 2-156 of the Municipal Code have the same meanings when used in this Part D.

1. In accordance with Section 2-156-110 of the Municipal Code: Does any official or employee of the City have a financial interest in his or her own name or in the name of any other person or entity in the Matter?

Yes No

NOTE: If you checked "Yes" to Item D.1., proceed to Items D.2. and D.3. If you checked "No" to Item D.1., proceed to Part E.

2. Unless sold pursuant to a process of competitive bidding, or otherwise permitted, no City elected official or employee shall have a financial interest in his or her own name or in the name of any other person or entity in the purchase of any property that (i) belongs to the City, or (ii) is sold for taxes or assessments, or (iii) is sold by virtue of legal process at the suit of the City (collectively, "City Property Sale"). Compensation for property taken pursuant to the City's eminent domain power does not constitute a financial interest within the meaning of this Part D.

Does the Matter involve a City Property Sale?

Yes No

3. If you checked "Yes" to Item D.1., provide the names and business addresses of the City officials or employees having such interest and identify the nature of such interest:

Name	Business Address	Nature of Interest
_____	_____	_____
_____	_____	_____
_____	_____	_____

4. The Disclosing Party further certifies that no prohibited financial interest in the Matter will be acquired by any City official or employee.

E. CERTIFICATION REGARDING SLAVERY ERA BUSINESS

Please check either 1. or 2. below. If the Disclosing Party checks 2., the Disclosing Party must disclose below or in an attachment to this EDS all information required by paragraph 2. Failure to

comply with these disclosure requirements may make any contract entered into with the City in connection with the Matter voidable by the City.

 X 1. The Disclosing Party verifies that the Disclosing Party has searched any and all records of the Disclosing Party and any and all predecessor entities regarding records of investments or profits from slavery or slaveholder insurance policies during the slavery era (including insurance policies issued to slaveholders that provided coverage for damage to or injury or death of their slaves), and the Disclosing Party has found no such records.

 2. The Disclosing Party verifies that, as a result of conducting the search in step 1 above, the Disclosing Party has found records of investments or profits from slavery or slaveholder insurance policies. The Disclosing Party verifies that the following constitutes full disclosure of all such records, including the names of any and all slaves or slaveholders described in those records:

SECTION VI -- CERTIFICATIONS FOR FEDERALLY FUNDED MATTERS

NOTE: If the Matter is federally funded, complete this Section VI. If the Matter is not federally funded, proceed to Section VII. For purposes of this Section VI, tax credits allocated by the City and proceeds of debt obligations of the City are not federal funding.

A. CERTIFICATION REGARDING LOBBYING

1. List below the names of all persons or entities registered under the federal Lobbying Disclosure Act of 1995 who have made lobbying contacts on behalf of the Disclosing Party with respect to the Matter: (Add sheets if necessary):

(If no explanation appears or begins on the lines above, or if the letters "NA" or if the word "None" appear, it will be conclusively presumed that the Disclosing Party means that NO persons or entities registered under the Lobbying Disclosure Act of 1995 have made lobbying contacts on behalf of the Disclosing Party with respect to the Matter.)

2. The Disclosing Party has not spent and will not expend any federally appropriated funds to pay any person or entity listed in Paragraph A.1. above for his or her lobbying activities or to pay any person or entity to influence or attempt to influence an officer or employee of any agency, as defined by applicable federal law, a member of Congress, an officer or employee of Congress, or an employee of a member of Congress, in connection with the award of any federally funded contract, making any federally funded grant or loan, entering into any cooperative agreement, or to extend, continue, renew, amend, or modify any federally funded contract, grant, loan, or cooperative agreement.

3. The Disclosing Party will submit an updated certification at the end of each calendar quarter in which there occurs any event that materially affects the accuracy of the statements and information set forth in paragraphs A.1. and A.2. above.

4. The Disclosing Party certifies that either: (i) it is not an organization described in section 501(c)(4) of the Internal Revenue Code of 1986; or (ii) it is an organization described in section 501(c)(4) of the Internal Revenue Code of 1986 but has not engaged and will not engage in "Lobbying Activities".

5. If the Disclosing Party is the Applicant, the Disclosing Party must obtain certifications equal in form and substance to paragraphs A.1. through A.4. above from all subcontractors before it awards any subcontract and the Disclosing Party must maintain all such subcontractors' certifications for the duration of the Matter and must make such certifications promptly available to the City upon request.

B. CERTIFICATION REGARDING EQUAL EMPLOYMENT OPPORTUNITY

If the Matter is federally funded, federal regulations require the Applicant and all proposed subcontractors to submit the following information with their bids or in writing at the outset of negotiations.

Is the Disclosing Party the Applicant?

Yes No

If "Yes," answer the three questions below:

1. Have you developed and do you have on file affirmative action programs pursuant to applicable federal regulations? (See 41 CFR Part 60-2.)

Yes No

2. Have you filed with the Joint Reporting Committee, the Director of the Office of Federal Contract Compliance Programs, or the Equal Employment Opportunity Commission all reports due under the applicable filing requirements?

Yes No

3. Have you participated in any previous contracts or subcontracts subject to the equal opportunity clause?

Yes No

If you checked "No" to question 1. or 2. above, please provide an explanation:

SECTION VII -- ACKNOWLEDGMENTS, CONTRACT INCORPORATION, COMPLIANCE, PENALTIES, DISCLOSURE

The Disclosing Party understands and agrees that:

A. The certifications, disclosures, and acknowledgments contained in this EDS will become part of any contract or other agreement between the Applicant and the City in connection with the Matter, whether procurement, City assistance, or other City action, and are material inducements to the City's execution of any contract or taking other action with respect to the Matter. The Disclosing Party understands that it must comply with all statutes, ordinances, and regulations on which this EDS is based.

B. The City's Governmental Ethics and Campaign Financing Ordinances, Chapters 2-156 and 2-164 of the Municipal Code, impose certain duties and obligations on persons or entities seeking City contracts, work, business, or transactions. The full text of these ordinances and a training program is available on line at www.cityofchicago.org/Ethics, and may also be obtained from the City's Board of Ethics, 740 N.

Sedgwick St., Suite 500, Chicago, IL 60610, (312) 744-9660. The Disclosing Party must comply fully with the applicable ordinances.

C. If the City determines that any information provided in this EDS is false, incomplete or inaccurate, any contract or other agreement in connection with which it is submitted may be rescinded or be void or voidable, and the City may pursue any remedies under the contract or agreement (if not rescinded or void), at law, or in equity, including terminating the Disclosing Party's participation in the Matter and/or declining to allow the Disclosing Party to participate in other transactions with the City. Remedies at law for a false statement of material fact may include incarceration and an award to the City of treble damages.

D. It is the City's policy to make this document available to the public on its Internet site and/or upon request. Some or all of the information provided on this EDS and any attachments to this EDS may be made available to the public on the Internet, in response to a Freedom of Information Act request, or otherwise. By completing and signing this EDS, the Disclosing Party waives and releases any possible rights or claims which it may have against the City in connection with the public release of information contained in this EDS and also authorizes the City to verify the accuracy of any information submitted in this EDS.

E. The information provided in this EDS must be kept current. In the event of changes, the Disclosing Party must supplement this EDS up to the time the City takes action on the Matter. If the Matter is a contract being handled by the City's Department of Procurement Services, the Disclosing Party must update this EDS as the contract requires. **NOTE:** With respect to Matters subject to Article I of Chapter 1-23 of the Municipal Code (imposing **PERMANENT INELIGIBILITY** for certain specified offenses), the information provided herein regarding eligibility must be kept current for a longer period, as required by Chapter 1-23 and Section 2-154-020 of the Municipal Code.

The Disclosing Party represents and warrants that:

F.1. The Disclosing Party is not delinquent in the payment of any tax administered by the Illinois Department of Revenue, nor are the Disclosing Party or its Affiliated Entities delinquent in paying any fine, fee, tax or other charge owed to the City. This includes, but is not limited to, all water charges, sewer charges, license fees, parking tickets, property taxes or sales taxes, other than real property taxes with respect to the subject property for which estimates of redemption have been ordered and which taxes are intended to be paid in full at the time of closing of the sale of the subject property which is anticipated to be on October 31, 2013.

F.2 If the Disclosing Party is the Applicant, the Disclosing Party and its Affiliated Entities will not use, nor permit their subcontractors to use, any facility listed by the U.S. E.P.A. on the federal Excluded Parties List System ("EPLS") maintained by the U. S. General Services Administration.

F.3 If the Disclosing Party is the Applicant, the Disclosing Party will obtain from any contractors/subcontractors hired or to be hired in connection with the Matter certifications equal in form and substance to those in F.1. and F.2. above and will not, without the prior written consent of the City, use any such contractor/subcontractor that does not provide such certifications or that the Disclosing Party has reason to believe has not provided or cannot provide truthful certifications.

NOTE: If the Disclosing Party cannot certify as to any of the items in F.1., F.2. or F.3. above, an explanatory statement must be attached to this EDS.

CERTIFICATION

Under penalty of perjury, the person signing below: (1) warrants that he/she is authorized to execute this EDS and Appendix A (if applicable) on behalf of the Disclosing Party, and (2) warrants that all certifications and statements contained in this EDS and Appendix A (if applicable) are true, accurate and complete as of the date furnished to the City.

Mary Ann Phillips

(Print or type name of Disclosing Party)

By:

(Sign here)

Mary Ann Phillips

(Print or type name of person signing)

Beneficiary of trust

(Print or type title of person signing)

Signed and sworn to before me on (date) October 31, 2013,
at Cook County, IL (state).

Elizabeth A. Soto Notary Public.

Commission expires: 10/21/16.

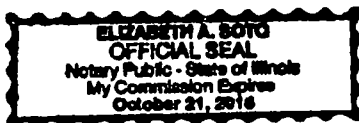

1

1

1

1

**CITY OF CHICAGO
ECONOMIC DISCLOSURE STATEMENT AND AFFIDAVIT
APPENDIX A**

FAMILIAL RELATIONSHIPS WITH ELECTED CITY OFFICIALS AND DEPARTMENT HEADS

This Appendix is to be completed only by (a) the Applicant, and (b) any legal entity which has a direct ownership interest in the Applicant exceeding 7.5 percent. It is not to be completed by any legal entity which has only an indirect ownership interest in the Applicant.

Under Municipal Code Section 2-154-015, the Disclosing Party must disclose whether such Disclosing Party or any “Applicable Party” or any Spouse or Domestic Partner thereof currently has a “familial relationship” with any elected city official or department head. A “familial relationship” exists if, as of the date this EDS is signed, the Disclosing Party or any “Applicable Party” or any Spouse or Domestic Partner thereof is related to the mayor, any alderman, the city clerk, the city treasurer or any city department head as spouse or domestic partner or as any of the following, whether by blood or adoption: parent, child, brother or sister, aunt or uncle, niece or nephew, grandparent, grandchild, father-in-law, mother-in-law, son-in-law, daughter-in-law, stepfather or stepmother, stepson or stepdaughter, stepbrother or stepsister or half-brother or half-sister.

“Applicable Party” means (1) all executive officers of the Disclosing Party listed in Section II.B.1.a., if the Disclosing Party is a corporation; all partners of the Disclosing Party, if the Disclosing Party is a general partnership; all general partners and limited partners of the Disclosing Party, if the Disclosing Party is a limited partnership; all managers, managing members and members of the Disclosing Party, if the Disclosing Party is a limited liability company; (2) all principal officers of the Disclosing Party; and (3) any person having more than a 7.5 percent ownership interest in the Disclosing Party. “Principal officers” means the president, chief operating officer, executive director, chief financial officer, treasurer or secretary of a legal entity or any person exercising similar authority.

Does the Disclosing Party or any “Applicable Party” or any Spouse or Domestic Partner thereof currently have a “familial relationship” with an elected city official or department head?

Yes

No

If yes, please identify below (1) the name and title of such person, (2) the name of the legal entity to which such person is connected; (3) the name and title of the elected city official or department head to whom such person has a familial relationship, and (4) the precise nature of such familial relationship.

**CITY OF CHICAGO
ECONOMIC DISCLOSURE STATEMENT
AND AFFIDAVIT**

SECTION I -- GENERAL INFORMATION

A. Legal name of the Disclosing Party submitting this EDS. Include d/b/a/ if applicable:

Barbara Vary

Check ONE of the following three boxes:

Indicate whether the Disclosing Party submitting this EDS is:

1. the Applicant /Owner

OR

2. a legal entity holding a direct or indirect interest in the Applicant. State the legal name of the Applicant in which the Disclosing Party holds an interest: _____

OR

3. a legal entity with a right of control (see Section II.B.1.) State the legal name of the entity in which the Disclosing Party holds a right of control: _____

B. Business address of the Disclosing Party: _____

C. Telephone: _____ x: _____ Email: _____

D. Name of contact person: self

E. Federal Employer Identification No. (if you have one): _____

F. Brief description of contract, transaction or other undertaking (referred to below as the "Matter") to which this EDS pertains. (Include project number and location of property, if applicable):

PD application for 1150-68 North Halsted

G. Which City agency or department is requesting this EDS? DHED, Dept. of Law

If the Matter is a contract being handled by the City's Department of Procurement Services, please complete the following:

Specification # _____ and Contract # _____

SECTION II -- DISCLOSURE OF OWNERSHIP INTERESTS

A. NATURE OF THE DISCLOSING PARTY

1. Indicate the nature of the Disclosing Party:

- Person
 - Publicly registered business corporation
 - Privately held business corporation
 - Sole proprietorship
 - General partnership
 - Limited partnership
 - Trust
 - Limited liability company
 - Limited liability partnership
 - Joint venture
 - Not-for-profit corporation
- (Is the not-for-profit corporation also a 501(c)(3))?
 Yes No
 Other (please specify)
-

2. For legal entities, the state (or foreign country) of incorporation or organization, if applicable:

3. For legal entities not organized in the State of Illinois: Has the organization registered to do business in the State of Illinois as a foreign entity?

- Yes
- No
- N/A

B. IF THE DISCLOSING PARTY IS A LEGAL ENTITY:

1. List below the full names and titles of all executive officers and all directors of the entity.

NOTE: For not-for-profit corporations, also list below all members, if any, which are legal entities. If there are no such members, write "no members." For trusts, estates or other similar entities, list below the legal titleholder(s).

If the entity is a general partnership, limited partnership, limited liability company, limited liability partnership or joint venture, list below the name and title of each general partner, managing member, manager or any other person or entity that controls the day-to-day management of the Disclosing Party.

NOTE: Each legal entity listed below must submit an EDS on its own behalf.

Name	Title
N/A	
_____	_____
_____	_____
_____	_____
_____	_____

2. Please provide the following information concerning each person or entity having a direct or indirect beneficial interest (including ownership) in excess of 7.5% of the Disclosing Party. Examples of such an interest include shares in a corporation, partnership interest in a partnership or joint venture,

interest of a member or manager in a limited liability company, or interest of a beneficiary of a trust, estate or other similar entity. If none, state "None." **NOTE:** Pursuant to Section 2-154-030 of the Municipal Code of Chicago ("Municipal Code"), the City may require any such additional information from any applicant which is reasonably intended to achieve full disclosure.

Name	Business Address	Percentage Interest in the Disclosing Party
<hr/>		
<hr/>		
<hr/>		

SECTION III -- BUSINESS RELATIONSHIPS WITH CITY ELECTED OFFICIALS

Has the Disclosing Party had a "business relationship," as defined in Chapter 2-156 of the Municipal Code, with any City elected official in the 12 months before the date this EDS is signed?

Yes No

If yes, please identify below the name(s) of such City elected official(s) and describe such relationship(s):

SECTION IV -- DISCLOSURE OF SUBCONTRACTORS AND OTHER RETAINED PARTIES

The Disclosing Party must disclose the name and business address of each subcontractor, attorney, lobbyist, accountant, consultant and any other person or entity whom the Disclosing Party has retained or expects to retain in connection with the Matter, as well as the nature of the relationship, and the total amount of the fees paid or estimated to be paid. The Disclosing Party is not required to disclose employees who are paid solely through the Disclosing Party's regular payroll.

"Lobbyist" means any person or entity who undertakes to influence any legislative or administrative action on behalf of any person or entity other than: (1) a not-for-profit entity, on an unpaid basis, or (2) himself. "Lobbyist" also means any person or entity any part of whose duties as an employee of another includes undertaking to influence any legislative or administrative action.

If the Disclosing Party is uncertain whether a disclosure is required under this Section, the Disclosing Party must either ask the City whether disclosure is required or make the disclosure.

Name (indicate whether retained or anticipated to be retained)	Business Address	Relationship to Disclosing Party (subcontractor, attorney, lobbyist, etc.)	Fees (indicate whether paid or estimated.) NOTE: "hourly rate" or "t.b.d." is not an acceptable response.
--	------------------	--	--

(Add sheets if necessary)

Check here if the Disclosing Party has not retained, nor expects to retain, any such persons or entities.

SECTION V -- CERTIFICATIONS

A. COURT-ORDERED CHILD SUPPORT COMPLIANCE

Under Municipal Code Section 2-92-415, substantial owners of business entities that contract with the City must remain in compliance with their child support obligations throughout the contract's term.

Has any person who directly or indirectly owns 10% or more of the Disclosing Party been declared in arrearage on any child support obligations by any Illinois court of competent jurisdiction?

Yes No No person directly or indirectly owns 10% or more of the Disclosing Party.

If "Yes," has the person entered into a court-approved agreement for payment of all support owed and is the person in compliance with that agreement?

Yes No

B. FURTHER CERTIFICATIONS

1. Pursuant to Municipal Code Chapter 1-23, Article I ("Article I")(which the Applicant should consult for defined terms (e.g., "doing business") and legal requirements), if the Disclosing Party submitting this EDS is the Applicant and is doing business with the City, then the Disclosing Party certifies as follows: (i) neither the Applicant nor any controlling person is currently indicted or charged with, or has admitted guilt of, or has ever been convicted of, or placed under supervision for, any criminal offense involving actual, attempted, or conspiracy to commit bribery, theft, fraud, forgery, perjury, dishonesty or deceit against an officer or employee of the City or any sister agency; and (ii) the Applicant understands and acknowledges that compliance with Article I is a continuing requirement for doing business with the City. **NOTE:** If Article I applies to the Applicant, the permanent compliance timeframe in Article I supersedes some five-year compliance timeframes in certifications 2 and 3 below.

2. The Disclosing Party and, if the Disclosing Party is a legal entity, all of those persons or entities identified in Section II.B.1. of this EDS:

- a. are not presently debarred, suspended, proposed for debarment, declared ineligible or voluntarily excluded from any transactions by any federal, state or local unit of government;
- b. have not, within a five-year period preceding the date of this EDS, been convicted of a criminal offense, adjudged guilty, or had a civil judgment rendered against them in connection with: obtaining, attempting to obtain, or performing a public (federal, state or local) transaction or contract under a public transaction; a violation of federal or state antitrust statutes; fraud; embezzlement; theft; forgery; bribery; falsification or destruction of records; making false statements; or receiving stolen property;
- c. are not presently indicted for, or criminally or civilly charged by, a governmental entity (federal, state or local) with committing any of the offenses set forth in clause B.2.b. of this Section V;
- d. have not, within a five-year period preceding the date of this EDS, had one or more public transactions (federal, state or local) terminated for cause or default; and
- e. have not, within a five-year period preceding the date of this EDS, been convicted, adjudged guilty, or found liable in a civil proceeding, or in any criminal or civil action, including actions concerning environmental violations, instituted by the City or by the federal government, any state, or any other unit of local government.

3. The certifications in subparts 3, 4 and 5 concern:

- the Disclosing Party;
- any "Contractor" (meaning any contractor or subcontractor used by the Disclosing Party in connection with the Matter, including but not limited to all persons or legal entities disclosed under Section IV, "Disclosure of Subcontractors and Other Retained Parties");
- any "Affiliated Entity" (meaning a person or entity that, directly or indirectly: controls the Disclosing Party, is controlled by the Disclosing Party, or is, with the Disclosing Party, under common control of another person or entity. Indicia of control include, without limitation: interlocking management or ownership; identity of interests among family members, shared facilities and equipment; common use of employees; or organization of a business entity following the ineligibility of a business entity to do business with federal or state or local government, including the City, using substantially the same management, ownership, or principals as the ineligible entity); with respect to Contractors, the term Affiliated Entity means a person or entity that directly or indirectly controls the Contractor, is controlled by it, or, with the Contractor, is under common control of another person or entity;
- any responsible official of the Disclosing Party, any Contractor or any Affiliated Entity or any other official, agent or employee of the Disclosing Party, any Contractor or any Affiliated Entity, acting pursuant to the direction or authorization of a responsible official of the Disclosing Party, any Contractor or any Affiliated Entity (collectively "Agents").

Neither the Disclosing Party, nor any Contractor, nor any Affiliated Entity of either the Disclosing Party or any Contractor nor any Agents have, during the five years before the date this EDS is signed, or, with respect to a Contractor, an Affiliated Entity, or an Affiliated Entity of a Contractor during the five years before the date of such Contractor's or Affiliated Entity's contract or engagement in connection with the Matter:

- a. bribed or attempted to bribe, or been convicted or adjudged guilty of bribery or attempting to bribe, a public officer or employee of the City, the State of Illinois, or any agency of the federal government or of any state or local government in the United States of America, in that officer's or employee's official capacity;
- b. agreed or colluded with other bidders or prospective bidders, or been a party to any such agreement, or been convicted or adjudged guilty of agreement or collusion among bidders or prospective bidders, in restraint of freedom of competition by agreement to bid a fixed price or otherwise; or
- c. made an admission of such conduct described in a. or b. above that is a matter of record, but have not been prosecuted for such conduct; or
- d. violated the provisions of Municipal Code Section 2-92-610 (Living Wage Ordinance).

4. Neither the Disclosing Party, Affiliated Entity or Contractor, or any of their employees, officials, agents or partners, is barred from contracting with any unit of state or local government as a result of engaging in or being convicted of (1) bid-rigging in violation of 720 ILCS 5/33E-3; (2) bid-rotating in violation of 720 ILCS 5/33E-4; or (3) any similar offense of any state or of the United States of America that contains the same elements as the offense of bid-rigging or bid-rotating.

5. Neither the Disclosing Party nor any Affiliated Entity is listed on any of the following lists maintained by the Office of Foreign Assets Control of the U.S. Department of the Treasury or the Bureau of Industry and Security of the U.S. Department of Commerce or their successors: the Specially Designated Nationals List, the Denied Persons List, the Unverified List, the Entity List and the Debarred List.

6. The Disclosing Party understands and shall comply with the applicable requirements of Chapters 2-55 (Legislative Inspector General), 2-56 (Inspector General) and 2-156 (Governmental Ethics) of the Municipal Code.

7. If the Disclosing Party is unable to certify to any of the above statements in this Part B (Further Certifications), the Disclosing Party must explain below:

If the letters "NA," the word "None," or no response appears on the lines above, it will be conclusively presumed that the Disclosing Party certified to the above statements.

8. To the best of the Disclosing Party's knowledge after reasonable inquiry, the following is a complete list of all current employees of the Disclosing Party who were, at any time during the 12-month period preceding the execution date of this EDS, an employee, or elected or appointed official, of the City of Chicago (if none, indicate with "N/A" or "none").
N/A

9. To the best of the Disclosing Party's knowledge after reasonable inquiry, the following is a complete list of all gifts that the Disclosing Party has given or caused to be given, at any time during the 12-month period preceding the execution date of this EDS, to an employee, or elected or appointed official, of the City of Chicago. For purposes of this statement, a "gift" does not include: (i) anything made generally available to City employees or to the general public, or (ii) food or drink provided in the course of official City business and having a retail value of less than \$20 per recipient (if none, indicate with "N/A" or "none"). As to any gift listed below, please also list the name of the City recipient.
N/A

C. CERTIFICATION OF STATUS AS FINANCIAL INSTITUTION

1. The Disclosing Party certifies that the Disclosing Party (check one)

is is not

a "financial institution" as defined in Section 2-32-455(b) of the Municipal Code.

2. If the Disclosing Party IS a financial institution, then the Disclosing Party pledges:

"We are not and will not become a predatory lender as defined in Chapter 2-32 of the Municipal Code. We further pledge that none of our affiliates is, and none of them will become, a predatory lender as defined in Chapter 2-32 of the Municipal Code. We understand that becoming a predatory lender or becoming an affiliate of a predatory lender may result in the loss of the privilege of doing business with the City."

If the Disclosing Party is unable to make this pledge because it or any of its affiliates (as defined in Section 2-32-455(b) of the Municipal Code) is a predatory lender within the meaning of Chapter 2-32 of the Municipal Code, explain here (attach additional pages if necessary):

If the letters "NA," the word "None," or no response appears on the lines above, it will be conclusively presumed that the Disclosing Party certified to the above statements.

D. CERTIFICATION REGARDING INTEREST IN CITY BUSINESS

Any words or terms that are defined in Chapter 2-156 of the Municipal Code have the same meanings when used in this Part D.

1. In accordance with Section 2-156-110 of the Municipal Code: Does any official or employee of the City have a financial interest in his or her own name or in the name of any other person or entity in the Matter?

Yes No

NOTE: If you checked "Yes" to Item D.1., proceed to Items D.2. and D.3. If you checked "No" to Item D.1., proceed to Part E.

2. Unless sold pursuant to a process of competitive bidding, or otherwise permitted, no City elected official or employee shall have a financial interest in his or her own name or in the name of any other person or entity in the purchase of any property that (i) belongs to the City, or (ii) is sold for taxes or assessments, or (iii) is sold by virtue of legal process at the suit of the City (collectively, "City Property Sale"). Compensation for property taken pursuant to the City's eminent domain power does not constitute a financial interest within the meaning of this Part D.

Does the Matter involve a City Property Sale?

Yes No

3. If you checked "Yes" to Item D.1., provide the names and business addresses of the City officials or employees having such interest and identify the nature of such interest:

Name	Business Address	Nature of Interest
_____	_____	_____
_____	_____	_____
_____	_____	_____

4. The Disclosing Party further certifies that no prohibited financial interest in the Matter will be acquired by any City official or employee.

E. CERTIFICATION REGARDING SLAVERY ERA BUSINESS

Please check either 1. or 2. below. If the Disclosing Party checks 2., the Disclosing Party must disclose below or in an attachment to this EDS all information required by paragraph 2. Failure to

comply with these disclosure requirements may make any contract entered into with the City in connection with the Matter voidable by the City.

X 1. The Disclosing Party verifies that the Disclosing Party has searched any and all records of the Disclosing Party and any and all predecessor entities regarding records of investments or profits from slavery or slaveholder insurance policies during the slavery era (including insurance policies issued to slaveholders that provided coverage for damage to or injury or death of their slaves), and the Disclosing Party has found no such records.

2. The Disclosing Party verifies that, as a result of conducting the search in step 1 above, the Disclosing Party has found records of investments or profits from slavery or slaveholder insurance policies. The Disclosing Party verifies that the following constitutes full disclosure of all such records, including the names of any and all slaves or slaveholders described in those records:

SECTION VI -- CERTIFICATIONS FOR FEDERALLY FUNDED MATTERS

NOTE: If the Matter is federally funded, complete this Section VI. If the Matter is not federally funded, proceed to Section VII. For purposes of this Section VI, tax credits allocated by the City and proceeds of debt obligations of the City are not federal funding.

A. CERTIFICATION REGARDING LOBBYING

1. List below the names of all persons or entities registered under the federal Lobbying Disclosure Act of 1995 who have made lobbying contacts on behalf of the Disclosing Party with respect to the Matter: (Add sheets if necessary):

(If no explanation appears or begins on the lines above, or if the letters "NA" or if the word "None" appear, it will be conclusively presumed that the Disclosing Party means that NO persons or entities registered under the Lobbying Disclosure Act of 1995 have made lobbying contacts on behalf of the Disclosing Party with respect to the Matter.)

2. The Disclosing Party has not spent and will not expend any federally appropriated funds to pay any person or entity listed in Paragraph A.1. above for his or her lobbying activities or to pay any person or entity to influence or attempt to influence an officer or employee of any agency, as defined by applicable federal law, a member of Congress, an officer or employee of Congress, or an employee of a member of Congress, in connection with the award of any federally funded contract, making any federally funded grant or loan, entering into any cooperative agreement, or to extend, continue, renew, amend, or modify any federally funded contract, grant, loan, or cooperative agreement.

3. The Disclosing Party will submit an updated certification at the end of each calendar quarter in which there occurs any event that materially affects the accuracy of the statements and information set forth in paragraphs A.1. and A.2. above.

4. The Disclosing Party certifies that either: (i) it is not an organization described in section 501(c)(4) of the Internal Revenue Code of 1986; or (ii) it is an organization described in section 501(c)(4) of the Internal Revenue Code of 1986 but has not engaged and will not engage in "Lobbying Activities".

5. If the Disclosing Party is the Applicant, the Disclosing Party must obtain certifications equal in form and substance to paragraphs A.1. through A.4. above from all subcontractors before it awards any subcontract and the Disclosing Party must maintain all such subcontractors' certifications for the duration of the Matter and must make such certifications promptly available to the City upon request.

B. CERTIFICATION REGARDING EQUAL EMPLOYMENT OPPORTUNITY

If the Matter is federally funded, federal regulations require the Applicant and all proposed subcontractors to submit the following information with their bids or in writing at the outset of negotiations.

Is the Disclosing Party the Applicant?

Yes No

If "Yes," answer the three questions below:

1. Have you developed and do you have on file affirmative action programs pursuant to applicable federal regulations? (See 41 CFR Part 60-2.)

Yes No

2. Have you filed with the Joint Reporting Committee, the Director of the Office of Federal Contract Compliance Programs, or the Equal Employment Opportunity Commission all reports due under the applicable filing requirements?

Yes No

3. Have you participated in any previous contracts or subcontracts subject to the equal opportunity clause?

Yes No

If you checked "No" to question 1. or 2. above, please provide an explanation:

SECTION VII -- ACKNOWLEDGMENTS, CONTRACT INCORPORATION, COMPLIANCE, PENALTIES, DISCLOSURE

The Disclosing Party understands and agrees that:

A. The certifications, disclosures, and acknowledgments contained in this EDS will become part of any contract or other agreement between the Applicant and the City in connection with the Matter, whether procurement, City assistance, or other City action, and are material inducements to the City's execution of any contract or taking other action with respect to the Matter. The Disclosing Party understands that it must comply with all statutes, ordinances, and regulations on which this EDS is based.

B. The City's Governmental Ethics and Campaign Financing Ordinances, Chapters 2-156 and 2-164 of the Municipal Code, impose certain duties and obligations on persons or entities seeking City contracts, work, business, or transactions. The full text of these ordinances and a training program is available on line at www.cityofchicago.org/Ethics, and may also be obtained from the City's Board of Ethics, 740 N.

Sedgwick St., Suite 500, Chicago, IL 60610, (312) 744-9660. The Disclosing Party must comply fully with the applicable ordinances.

C. If the City determines that any information provided in this EDS is false, incomplete or inaccurate, any contract or other agreement in connection with which it is submitted may be rescinded or be void or voidable, and the City may pursue any remedies under the contract or agreement (if not rescinded or void), at law, or in equity, including terminating the Disclosing Party's participation in the Matter and/or declining to allow the Disclosing Party to participate in other transactions with the City. Remedies at law for a false statement of material fact may include incarceration and an award to the City of treble damages.

D. It is the City's policy to make this document available to the public on its Internet site and/or upon request. Some or all of the information provided on this EDS and any attachments to this EDS may be made available to the public on the Internet, in response to a Freedom of Information Act request, or otherwise. By completing and signing this EDS, the Disclosing Party waives and releases any possible rights or claims which it may have against the City in connection with the public release of information contained in this EDS and also authorizes the City to verify the accuracy of any information submitted in this EDS.

E. The information provided in this EDS must be kept current. In the event of changes, the Disclosing Party must supplement this EDS up to the time the City takes action on the Matter. If the Matter is a contract being handled by the City's Department of Procurement Services, the Disclosing Party must update this EDS as the contract requires. **NOTE:** With respect to Matters subject to Article I of Chapter 1-23 of the Municipal Code (imposing **PERMANENT INELIGIBILITY** for certain specified offenses), the information provided herein regarding eligibility must be kept current for a longer period, as required by Chapter 1-23 and Section 2-154-020 of the Municipal Code.

The Disclosing Party represents and warrants that:

F.1. The Disclosing Party is not delinquent in the payment of any tax administered by the Illinois Department of Revenue, nor are the Disclosing Party or its Affiliated Entities delinquent in paying any fine, fee, tax or other charge owed to the City. This includes, but is not limited to, all water charges, sewer charges, license fees, parking tickets, property taxes or sales taxes, other than real property taxes with respect to the subject property for which estimates of redemption have been ordered and which taxes are intended to be paid in full at the time of closing of the sale of the subject property which is anticipated to be on October 31, 2013.

F.2 If the Disclosing Party is the Applicant, the Disclosing Party and its Affiliated Entities will not use, nor permit their subcontractors to use, any facility listed by the U.S. E.P.A. on the federal Excluded Parties List System ("EPLS") maintained by the U. S. General Services Administration.

F.3 If the Disclosing Party is the Applicant, the Disclosing Party will obtain from any contractors/subcontractors hired or to be hired in connection with the Matter certifications equal in form and substance to those in F.1. and F.2. above and will not, without the prior written consent of the City, use any such contractor/subcontractor that does not provide such certifications or that the Disclosing Party has reason to believe has not provided or cannot provide truthful certifications.

NOTE: If the Disclosing Party cannot certify as to any of the items in F.1., F.2. or F.3. above, an explanatory statement must be attached to this EDS.

CERTIFICATION

Under penalty of perjury, the person signing below: (1) warrants that he/she is authorized to execute this EDS and Appendix A (if applicable) on behalf of the Disclosing Party, and (2) warrants that all certifications and statements contained in this EDS and Appendix A (if applicable) are true, accurate and complete as of the date furnished to the City.

Barbara Vary

(Print or type name of Disclosing Party)

By: Barbara Vary
(Sign here)

Barbara Vary

(Print or type name of person signing)

Beneficiary of trust

(Print or type title of person signing)

Signed and sworn to before me on (date) October 8, 2013,
at COOK County, IL (state).

Elizabeth A. Soto Notary Public.

Commission expires: 10/21/16

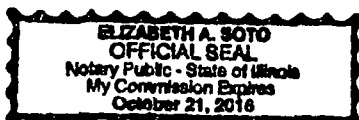

Handwritten text at the top of the page, possibly a title or header, which is mostly illegible due to fading and blurring.

Small, illegible text or a stamp located in the bottom right corner of the page.

**CITY OF CHICAGO
ECONOMIC DISCLOSURE STATEMENT AND AFFIDAVIT
APPENDIX A**

FAMILIAL RELATIONSHIPS WITH ELECTED CITY OFFICIALS AND DEPARTMENT HEADS

This Appendix is to be completed only by (a) the Applicant, and (b) any legal entity which has a direct ownership interest in the Applicant exceeding 7.5 percent. It is not to be completed by any legal entity which has only an indirect ownership interest in the Applicant.

Under Municipal Code Section 2-154-015, the Disclosing Party must disclose whether such Disclosing Party or any "Applicable Party" or any Spouse or Domestic Partner thereof currently has a "familial relationship" with any elected city official or department head. A "familial relationship" exists if, as of the date this EDS is signed, the Disclosing Party or any "Applicable Party" or any Spouse or Domestic Partner thereof is related to the mayor, any alderman, the city clerk, the city treasurer or any city department head as spouse or domestic partner or as any of the following, whether by blood or adoption: parent, child, brother or sister, aunt or uncle, niece or nephew, grandparent, grandchild, father-in-law, mother-in-law, son-in-law, daughter-in-law, stepfather or stepmother, stepson or stepdaughter, stepbrother or stepsister or half-brother or half-sister.

"Applicable Party" means (1) all executive officers of the Disclosing Party listed in Section II.B.1.a., if the Disclosing Party is a corporation; all partners of the Disclosing Party, if the Disclosing Party is a general partnership; all general partners and limited partners of the Disclosing Party, if the Disclosing Party is a limited partnership; all managers, managing members and members of the Disclosing Party, if the Disclosing Party is a limited liability company; (2) all principal officers of the Disclosing Party; and (3) any person having more than a 7.5 percent ownership interest in the Disclosing Party. "Principal officers" means the president, chief operating officer, executive director, chief financial officer, treasurer or secretary of a legal entity or any person exercising similar authority.

Does the Disclosing Party or any "Applicable Party" or any Spouse or Domestic Partner thereof currently have a "familial relationship" with an elected city official or department head?

Yes

No

If yes, please identify below (1) the name and title of such person, (2) the name of the legal entity to which such person is connected; (3) the name and title of the elected city official or department head to whom such person has a familial relationship, and (4) the precise nature of such familial relationship.

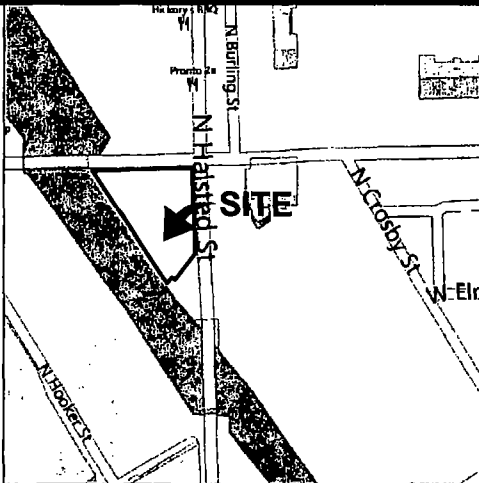

VICINITY MAP
NOT TO SCALE

SYMBOL LEGEND

- R/W - Right-of-Way
- P/L - Adjoiner Property Line
- ⊕ - Centerline
- P.O.B. - Place/Point of Beginning
- P.Q.C. - Place/Point of Commencement
- △ (with A) - Surveyor's Observation
- ⊗ (with X) - Schedule B-Section II Item
- Rad - Radius
- Arc - Arc Length
- Δ - Delta Angle
- ChL - Chord Length
- ChB - Chord Bearing
- Calc. - Calculated
- Msd. - Measured
- Dd. - Deed
- (Record) Actual
- N.R.D. - No Recorded Distance
- - Monumentation Found as Noted
- - 5/8" Iron Pin w/Cap Set
Stamped "MILLMAN 3303420723"
- ▲ - PK/MAG Nail or Railroad Spike
Found as Noted
- △ - MAG Nail or PK Nail Set
- - Monument in Monument Box
- ⊕ (with M) - Manhole
- ⊕ (with C) - Catch Basin
- ⊕ (with S) - Sanitary Manhole
- ⊕ (with F) - Fire Hydrant
- ⊕ (with W) - Water Valve
- ⊕ (with W) - Water Manhole
- ⊕ (with G) - Gas Meter
- ⊕ (with G) - Gas Valve
- ⊕ (with E) - Electric Manhole
- ⊕ (with E) - Electric Vault
- ⊕ (with T) - Telephone Manhole

millman

National Land Services

Transforming the Industry

Surveying
Zoning
Environmental
Real Support - Title Review

Millman Surveying, Inc.
Corporate Headquarters
1742 Georgetown Road, Suite H
Hudson, OH 44236
Phone: 800-520-1010
Fax: 330-342-0834
www.millmansurveying.com

ALTA/ACSM LAND TITLE
SURVEY PREPARED FOR:

Insite Real Estate, L.L.C.

1400 16th Street
Suite 300
Oak Brook, IL 60523

surveyor
information
30.com/25774136

CHICAGO TITLE INSURANCE COMPANY
COMMITMENT NO. 1401 008935372 D2 - SCHEDULE A:

BLOCK 73 IN ELSTON'S ADDITION TO CHICAGO, IN SECTIONS 4 AND 5, TOWNSHIP 39 NORTH, RANGE 14, EAST OF THE THIRD PRINCIPAL MERIDIAN (EXCEPT THAT PART TAKEN FOR STREETS AND EXCEPT THAT PART CONVEYED TO THE CITY OF CHICAGO BY DOCUMENT 11310046) IN COOK COUNTY, ILLINOIS.

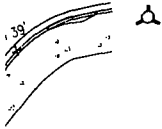

CHICAGO TITLE INSURANCE COMPANY
COMMITMENT NO. 1401 008935372 D2 - SCHEDULE B, SECTION II:

Numbers correspond with survey-related Schedule B exception items contained in the above referenced Title Commitment.

15. PERPETUAL EASEMENT IN FAVOR OF THE METROPOLITAN SANITARY DISTRICT OF GREATER CHICAGO OF RIGHT AND AUTHORITY TO CONSTRUCT, RECONSTRUCT, REPAIR, MAINTAIN AND OPERATE AN INTERCEPTING SEWER, DRAIN AND OUTLET WITH APPURTENANCES THERETO, UPON, UNDER AND THROUGH CERTAIN AREAS WHICH MAY INCLUDE THE BANK OF THE NORTH BRANCH OF THE CANAL OF THE CHICAGO RIVER AS CREATED BY ORDINANCE OF THE CITY OF CHICAGO RECORDED AUGUST 2, 1975 AS DOCUMENT 23137161 DOES NOT AFFECT THE SUBJECT PROPERTY - LIES WITHIN THE CURRENT RIGHT OF WAY OF N. HALSTED STREET

MISCELLANEOUS NOTES:

1. There is direct access to the subject property via North Halsted Street, a public right-of-way and North Branch Canal, a navigable waterway.
2. The location of the underground utilities shown hereon have been obtained by searches of available records, diligent field check, and field verified where accessible only. It is believed that they are essentially correct, but their accuracy or completeness is not guaranteed; therefore the contractor is urged to proceed with caution, follow the procedure for contacting the utility protection service prior to commencing construction, and field verify for accuracy, location and conditions.
3. The posted address on site is 1168 North Halsted Street.
4. At the time of this survey, there was no observable surface evidence of earth moving work, building construction or building additions within recent months.
5. At the time of this survey, there was no observable evidence of the subject property being used as a solid waste dump, sump or sanitary landfill.
6. At the time of this survey, there was no observable evidence of any recent changes in street right-of-way lines either completed or proposed, and available from the controlling jurisdiction.
7. At the time of this survey, there was no observable evidence of any recent street or sidewalk construction or repairs.
8. The Property surveyed and shown hereon is the same property described in Schedule A of Chicago Title Insurance Company Title Commitment No. 1401 008935372 D2 with an effective date of August 20.

West Division Street
 Variable Width - Public - Asphalt Pavement

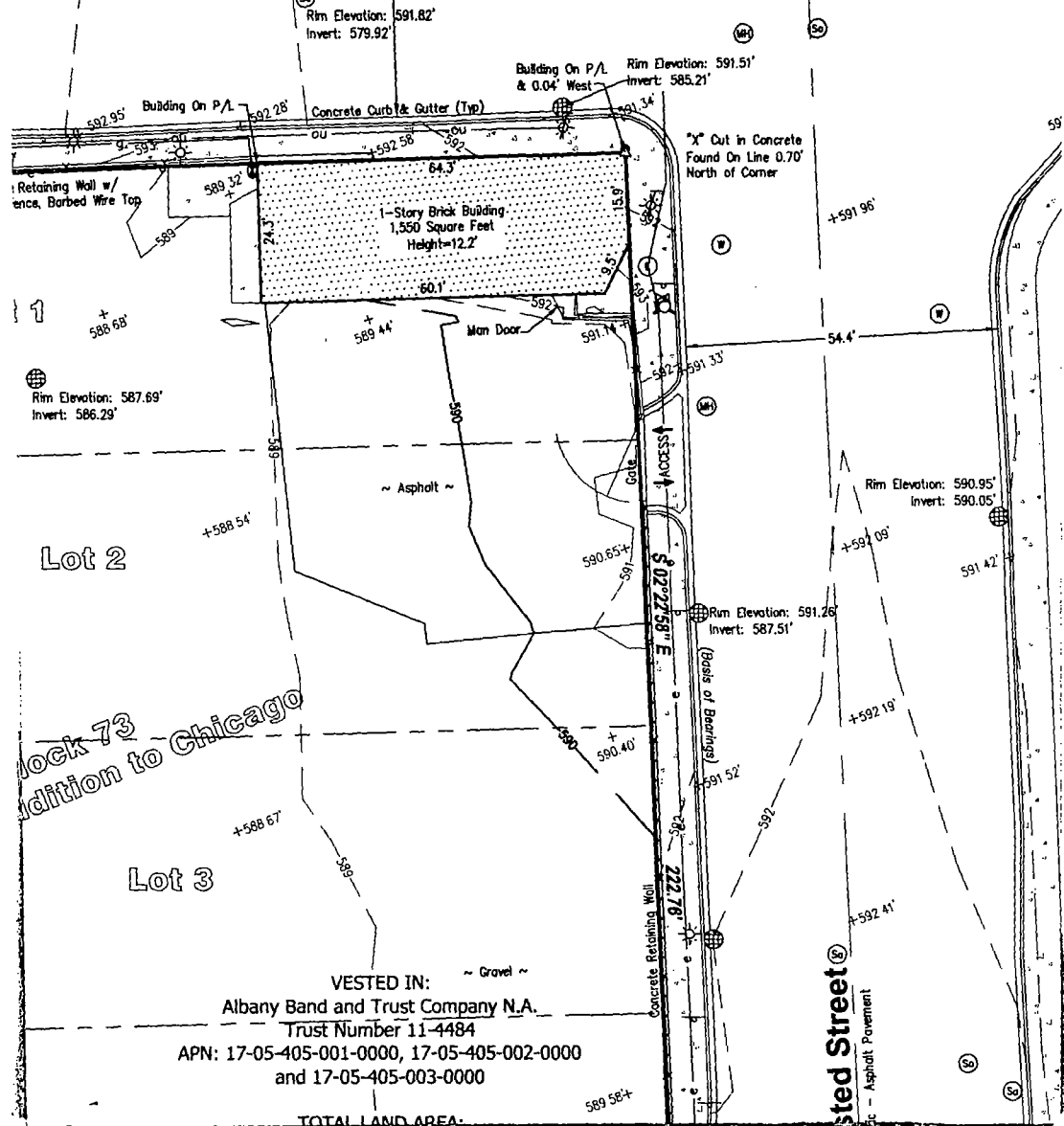

1
 Retaining Wall w/
 fence, Barbed Wire Top
 Rim Elevation: 588.68'
 Invert: 586.29'

Lot 2

Block 73
 Addition to Chicago









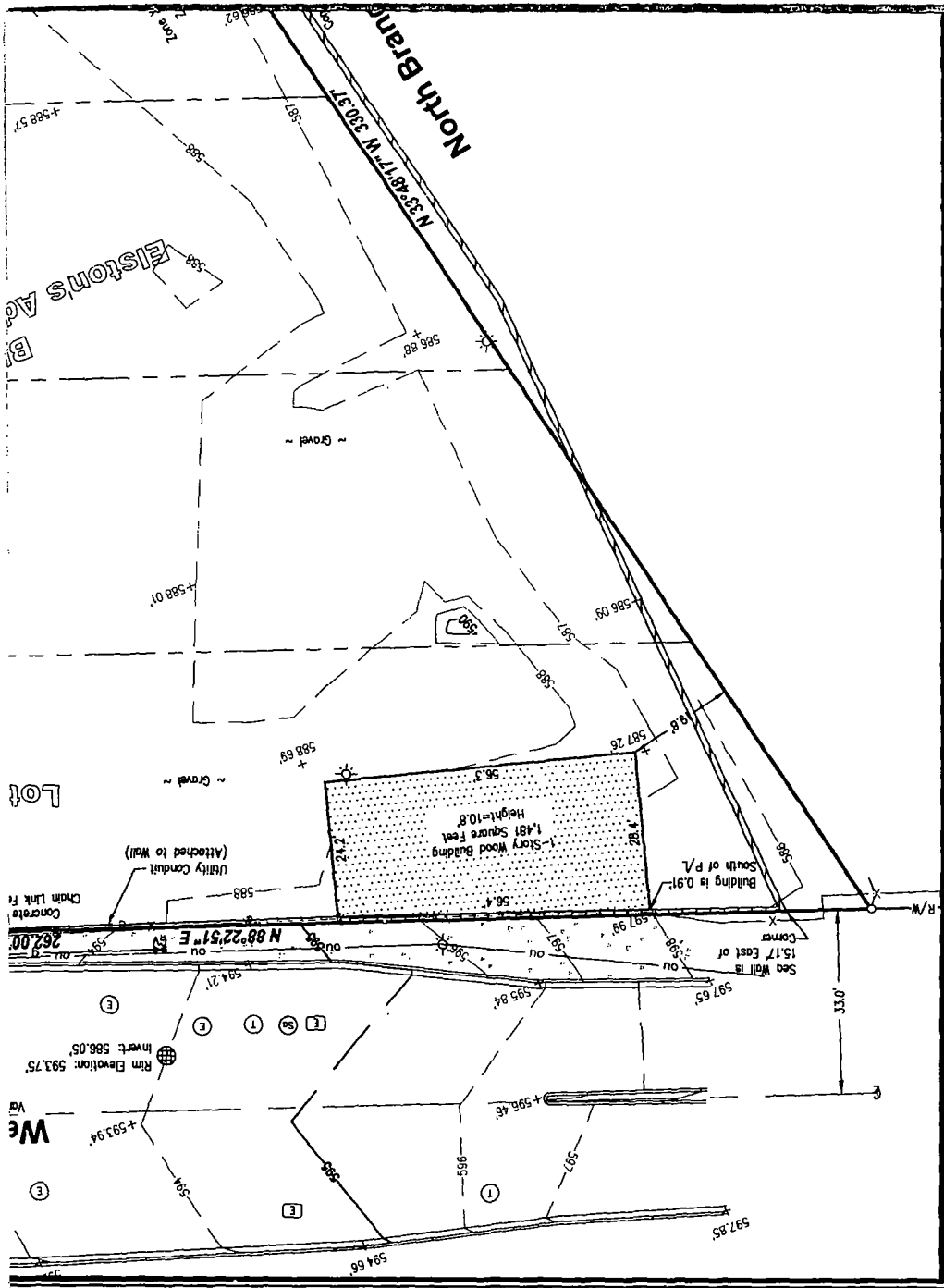

Lot 3

VESTED IN:
 Albany Band and Trust Company N.A.
 Trust Number 11-4484
 APN: 17-05-405-001-0000, 17-05-405-002-0000
 and 17-05-405-003-0000

TOTAL LAND AREA:

West Street
 Asphalt Pavement



-  - Traffic Pole
-  - Light Pole
-  - Guy Wire
-  - Fence (As Noted)
-  - Gravel Area
-  - Concrete Area
-  - No Parking Area
-  - Building Area
-  - Shaded Easement Area
-  - Light Shaded Easement Area
-  - Dark Shaded Easement Area

millman
virtual
for more
visit <http://vime>

1168 North Halsted Street
City of Chicago
County of Cook
State of Illinois

CERTIFICATION:

To: InSite Real Estate, L.L.C., InSite Real Estate Investment Properties, L.L.C., Chicago IL (1150) Halsted LLC and Chicago Title Insurance Company;

This is to certify that this map or plat and the survey on which it is based were made in accordance with the 2011 Minimum Standard Detail Requirements for ALTA/ACSM Land Title Surveys, jointly established and adopted by ALTA and NSPS, and includes Items 1, 2, 3, 4, 5, 6(b), 7(a), 7(b)(1), 7(c), 8, 9, 11(b), 13, 14, 15, 16, 17, 18, and 19 of Table A thereof. The field work was completed on June 17, 2013.

By: 
John Mark Norwood, PLS
Illinois License No. 35003795
License renewal date: 11/30/2014
Sheets covered by this Signature & Seal: Sheet 1 of 1
For and on behalf of Millman Surveying, Inc.

Certification Defined: The use of the word "certify" or "certification" by a licensed Professional Land Surveyor, in the practice of land surveying, constitutes an expression of professional opinion regarding those facts of findings which are subject of the certification, and does not constitute a warranty or guaranty, either express or implied. (*per section 6735.5 of the Business and Professional Code)

This professional service conforms to the current Illinois minimum standards for a boundary survey.



NORTH

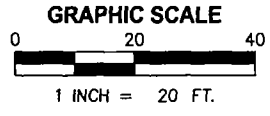

Surveyor's Seal

REVISION HISTORY		
BY:	DATE:	COMMENT:
JJT	9/30/13	PRELIMINARY SURVEY ISSUED
JJT	10/04/13	CLIENT COMMENTS
JJT	10/04/13	FINAL SURVEY ISSUED

Sheet No. **1** of **1**

MSI Project No. 29771

PM: JJT Drafter: JFD

FLOOD ZONE:

By scaled map location and graphic plotting only, the subject property appears to lie partially in Zone X-Unshaded (Areas determined to be outside the 0.2% annual chance floodplain.) and partially in Zone A (Special Flood Hazard Area; No base flood elevations determined.) according to the Flood Insurance Rate Map for the County of county, Community Panel No. 17031C 0419J, Effective Date August 19, 2008.

ZONING:

Zoning Classification: M3-3 (Heavy Industrial District)

Permitted Use:

Building Setbacks: Front=None, Rear=None, Side (River): 30 feet

Maximum Building Height: N/A

Parking Ratio: 1.25 spaces per 1,000 square feet of floor area

The building setback requirements are subject to further interpretation by the local zoning authority listed below and are not plotted or shown hereon. For further interpretation of the building setback requirements or other applicable zoning regulations, please refer to the local zoning authority listed below.

PARKING:

There are no striped parking spaces on the subject property.

BASIS OF BEARING:

The basis for all bearings shown hereon is the West line of N. Halsted Street, assumed as being South 02°22'58" East, and is used to denote angles only.

SURVEYOR'S OBSERVATIONS:

At the time of this survey, there was no visible evidence of encroachments or violations.

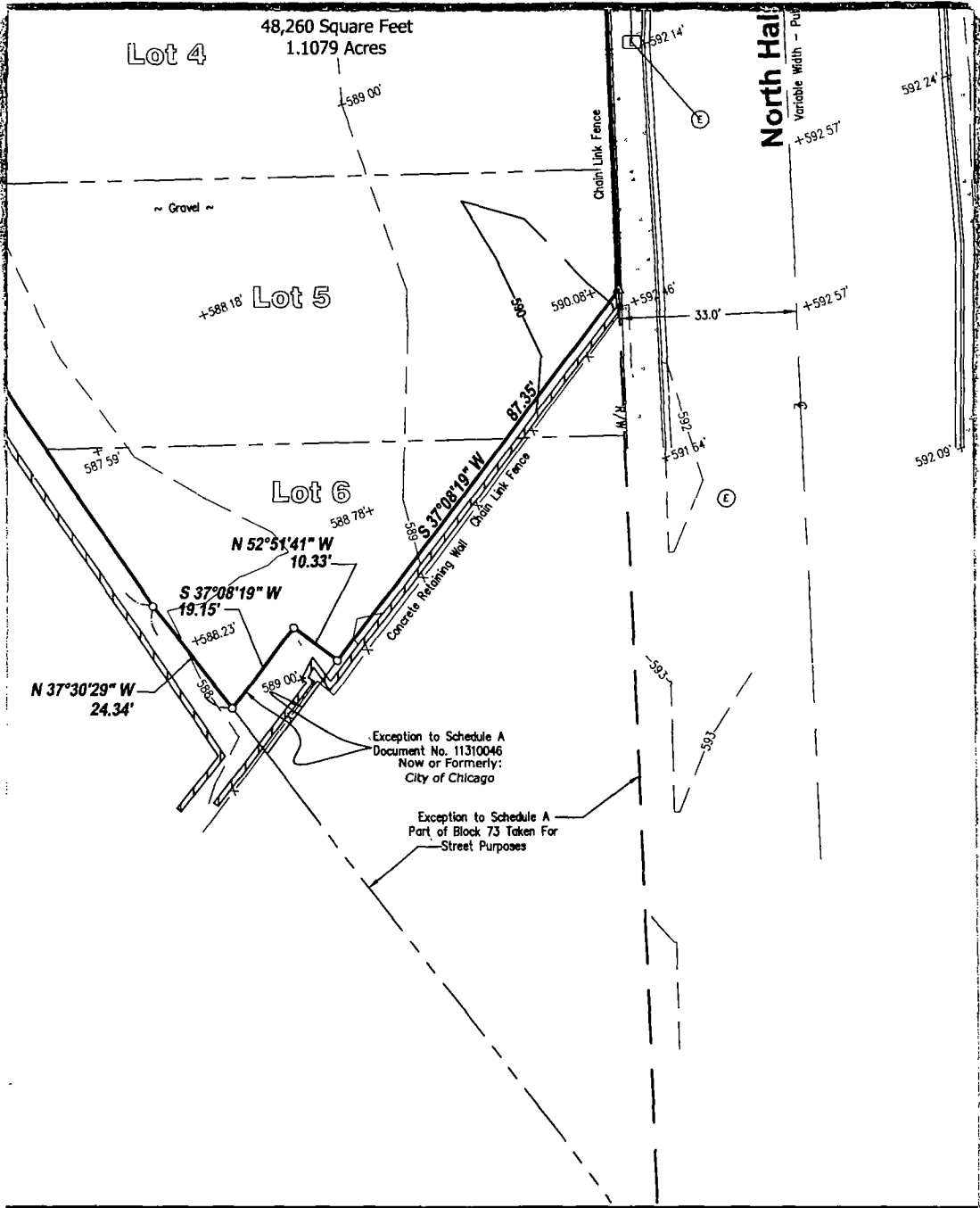

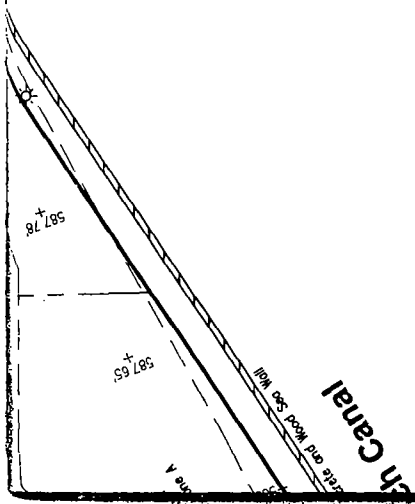

BUSINESS PLANNED DEVELOPMENT NO
PLANNED DEVELOPMENT STATEMENTS

1. The area delineated herein as Business Planned Development Number _____, (“Planned Development”) consists of approximately 47,000 square feet of property which is depicted on the attached Planned Development Boundary and Property Line Map (“Property”) and is owned or controlled by the Applicant, Chicago IL (1150 Halsted) LLC.
2. The requirements, obligations and conditions contained within this Planned Development shall be binding upon the Applicant, its successors and assigns and, if different than the Applicant, the legal title holders and any ground lessors. All rights granted hereunder to the Applicant shall inure to the benefit of the Applicant’s successors and assigns and, if different than the Applicant, the legal title holder and any ground lessors. Furthermore, pursuant to the requirements of Section 17-8-0400 of the Chicago Zoning Ordinance, the Property, at the time of application for amendments, modifications or changes (administrative, legislative or otherwise) to this Planned Development are made, shall be under single ownership or designated control. Single designated control is defined in Section 17-8-0400 of the Zoning Ordinance.
3. All applicable official reviews, approvals or permits are required to be obtained by the Applicant or its successors, assignees or grantees. Any dedication or vacation of streets or alleys or grants of easements or any adjustment of the right-of-way shall require a separate submittal to the Department of Transportation on behalf of the Applicant or its successors, assigns or grantees.

Any requests for grants of privilege, or any items encroaching on the public way, shall be in compliance with the Plans.

Ingress or egress shall be pursuant to the Plans and may be subject to the review and approval of the Departments of Housing and Economic Development and Transportation. Closure of all or any public street or alley during demolition or construction shall be subject to the review and approval of the Department of Transportation.

All work proposed in the public way must be designed and constructed in accordance with the Department of Transportation Construction Standards for Work in the Public Way and in compliance with the Municipal Code of the City of Chicago. Prior to the issuance of any Part II approval, the submitted plans must be approved by the Department of Transportation.

4. This Plan of Development consists of 15 Statements: a Bulk Regulations Table; an Existing Zoning and Existing Land-Use Map; a Planned Development Boundary and Property Line Map; Site Plan; Landscape Plan; a Green Roof Plan; Building Elevations (North, South, East and West) and Chicago Builds Green form prepared by Interplan LLC and W-T Civil Engineering, LLC and dated October 16, 2013, submitted herein. Full-sized copies of the Site Plan, Landscape Plan and Building Elevations are on file with the Department of Housing and Economic Development. In any instance where a provision of this Planned

Applicant:	Chicago IL (1150 Halsted) LLC
Address:	1150-68 North Halsted
Introduced:	October 16, 2013
Plan Commission:	TBD

Development conflicts with the Chicago Building Code, the Building Code shall control. This Planned Development conforms to the intent and purpose of the Zoning Ordinance, and all requirements thereto, and satisfies the established criteria for approval as a Planned Development. In case of a conflict between the terms of this Planned Development Ordinance and the Zoning Ordinance, this Planned Development Ordinance shall control.

5. The following uses are permitted in the area delineated herein as a Business Planned Development: commercial and retail uses, parking, and accessory uses.
6. On-Premise signs and temporary signs, such as construction and marketing signs, shall be permitted within the Planned Development, subject to the review and approval of the Department of Housing and Economic Development. Off-Premise signs are prohibited within the boundary of the Planned Development.
7. For purposes of height measurement, the definitions in the Zoning Ordinance shall apply. The height of any building shall also be subject to height limitations, if any, established by the Federal Aviation Administration.
8. The maximum permitted Floor Area Ratio (“FAR”) for the site shall be in accordance with the attached Bulk Regulations Table. For the purposes of FAR calculations and measurements, the definitions in the Zoning Ordinance shall apply. The permitted FAR identified in the Bulk Regulations Table has been determined using a Net Site Area of TBD square feet.
9. Upon review and determination, “Part II Review”, pursuant to Section 17-13-0610 of the Zoning Ordinance, a Part II Review Fee shall be assessed by the Department of Housing and Economic Development. The fee, as determined by staff at the time, is final and binding on the Applicant and must be paid to the Department of Revenue prior to the issuance of any Part II approval.
10. The Site and Landscape Plans shall be in substantial conformance with the Landscape Ordinance and any other corresponding regulations and guidelines. Final landscape plan review and approval will be by the Department of Housing and Economic Development. Any interim reviews associated with site plan review or Part II reviews, are conditional until final Part II approval.
11. The Applicant shall comply with Rules and Regulations for the Maintenance of Stockpiles promulgated by the Commissioners of the Departments of Streets and Sanitation, Fleet and Facility Management and Buildings, under Section 13-32-125 of the Municipal Code, or any other provision of that Code.
12. The terms and conditions of development under this Planned Development ordinance may be modified administratively, pursuant to section 17-13-0611-A of the Zoning Ordinance by the Zoning Administrator upon the application for such a modification by the Applicant, its

Applicant:	Chicago IL (1150 Halsted) LLC
Address:	1150-68 North Halsted
Introduced:	October 16, 2013
Plan Commission:	TBD

successors and assigns and, if different than the Applicant, the legal title holders and any ground lessors.

13. The Applicant acknowledges that it is in the public interest to design, construct and maintain the project in a manner which promotes, enables and maximizes universal access throughout the Property. Plans for all buildings and improvements on the Property shall be reviewed and approved by the Mayor's Office for People with Disabilities to ensure compliance with all applicable laws and regulations related to access for persons with disabilities and to promote the highest standard of accessibility.
14. The Applicant acknowledges that it is in the public interest to design, construct, renovate and maintain all buildings in a manner that provides healthier indoor environments, reduces operating costs and conserves energy and natural resources. Consistent with the City of Chicago Sustainable Development Policy set forth by the Housing and Economic Development, 90% of the net roof area shall be green roof (16,366 square feet of net roof area with 14,182 square feet of green roof).
15. This Planned Development shall be governed by Section 17-13-0612 of the Zoning Ordinance. Should this Planned Development ordinance lapse, the Commissioner of the Department of Housing and Economic Development shall initiate a Zoning Map Amendment to rezone the property to C3-3 Commercial, Manufacturing and Employment District.

Applicant:	Chicago IL (1150 Halsted) LLC
Address:	1150-68 North Halsted
Introduced:	October 16, 2013
Plan Commission:	TBD

INTERPLANE

ARCHITECTURE
ENGINEERING
INTERIOR DESIGN
PROJECT
MANAGEMENT

AA 003420
CA 8660

ONE SOUTH 280
SUMMIT AVE SUITE D
OAKBROOK TERRACE, IL
60181
PH 630.932.2336
FX 630.932.2339

SEAL

CONSULTANT:

W-T

W-T CIVIL ENGINEERING, LLC

CIVIL AND STRUCTURAL ENGINEERING
3975 Piquette Avenue
Northbrook, Illinois 60062
PH: (847) 293-8222 FAX: (847) 293-8844
www.wt-engineering.com
E: LICENSE NO. 184-000493 Exp 07/2013

REVISIONS:

NO	DATE	REMARKS
00-01	-13	LOD
10-08	-13	PLANNED DEVELOPMENT

Interplan Civil, LLC
1401 West Street, Suite 200 | Oak Brook, IL 60057-3484
1.630.617.0101 | 630.617.0120 | www.interplan.com

InSite

West Marine

DIVISION ST. & HALSTED ST
CHICAGO, IL

COPYRIGHT © 2013
INTERPLAN LLC RESERVES
COPYRIGHT & OTHER
RIGHTS RESTRICTING
THESE DOCUMENTS TO
THE ORIGINAL SITE OR
PURPOSE FOR WHICH
THEY WERE PREPARED
REPRODUCTIONS, CHANGES
OR ASSIGNMENTS ARE
PROHIBITED

PROJECT NO: 2013.0229
DATE:

SITE
PLAN

SP-1.0

CHECKED:

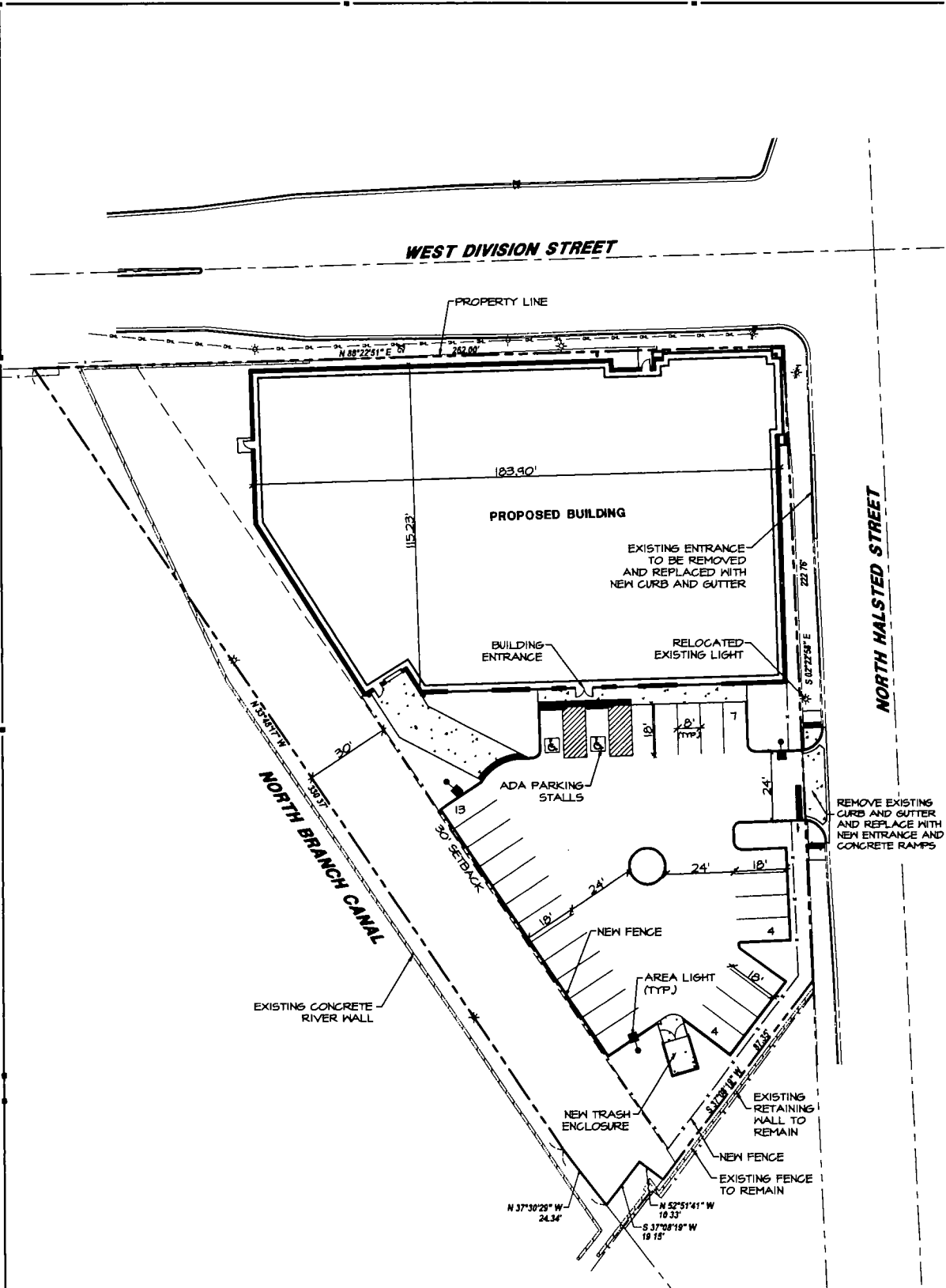

SITE PLAN
Applicant: Chicago, IL (1150 Halsted) LLC
Address: 1150-68 North Halsted
Introduction Date: October 16th, 2013

SCALE 1" = 50'



INTERPLAN

ARCHITECTURE
ENGINEERING
INTERIOR DESIGN
PROJECT
MANAGEMENT

AA 003420
CA 8860

ONE SOUTH 280
SUMMIT AVE SUITE D
OAKBROOK TERRACE, IL
60181
PH 630.932.2336
FX 630.932.2339

SEAL:

CONSULTANT:

WT

WEST MARINE

2075 Franklin Avenue
Chicago, Illinois 60618
PH: (773) 363-8223 FAX: (773) 363-8444
www.westmarine.com
E: Lakeside@wm 184-002492 Exp. 03/2013

REVISIONS:

NO.	DATE	REMARKS
08-01-13	LAB	
10-08-13	LAB	PLANNED DEVELOPMENT

BUSINESS PLANNED DEVELOPMENT BULK REGULATIONS AND DATA TABLE	
GROSS SITE AREA	65,005 SF (1.44 ACRES)
NET SITE AREA	47,000 SF (1.08 ACRES)
AREA IN PUBLIC STREETS OR ALLEYS	18,005 SF (0.41 ACRES)
RETAIL BUILDING SQUARE FOOTAGE	20,000 SF
MAXIMUM FLOOR AREA RATIO	50
MINIMUM NUMBER OF PARKING SPACES	28
MINIMUM NUMBER OF OFF-STREET LOADING BERTHS	1 (10' x 25')
MINIMUM PERIPHERY SETBACKS	PER SITE PLAN
MAXIMUM PROPOSED BUILDING HEIGHT	23'-0"

1150 North Halsted, Suite 111, Chicago, IL 60642
1-800-878-8288 (Toll Free) 773-363-8223 (Chicago)
www.westmarine.com

InSite

West Marine
DIVISION ST. & HALSTED ST.
CHICAGO, IL

COPYRIGHT © 2013
INTERPLAN LLC RESERVES
COPYRIGHT & OTHER
RIGHTS RESTRICTING
THESE DOCUMENTS TO
THE ORIGINAL SITE OR
PURPOSE FOR WHICH
THEY WERE PREPARED.
REPRODUCTIONS, CHANGES
OR ASSIGNMENTS ARE
PROHIBITED.

PROJECT NO: 2013.0229
DATE:

BULK
REGULATION
TABLE
SP-2.0

CHECKED:

BULK REGULATION TABLE

Applicant: Chicago, IL (1150 Halsted) LLC
Address: 1150-68 North Halsted
Introduction Date: October 16th, 2013

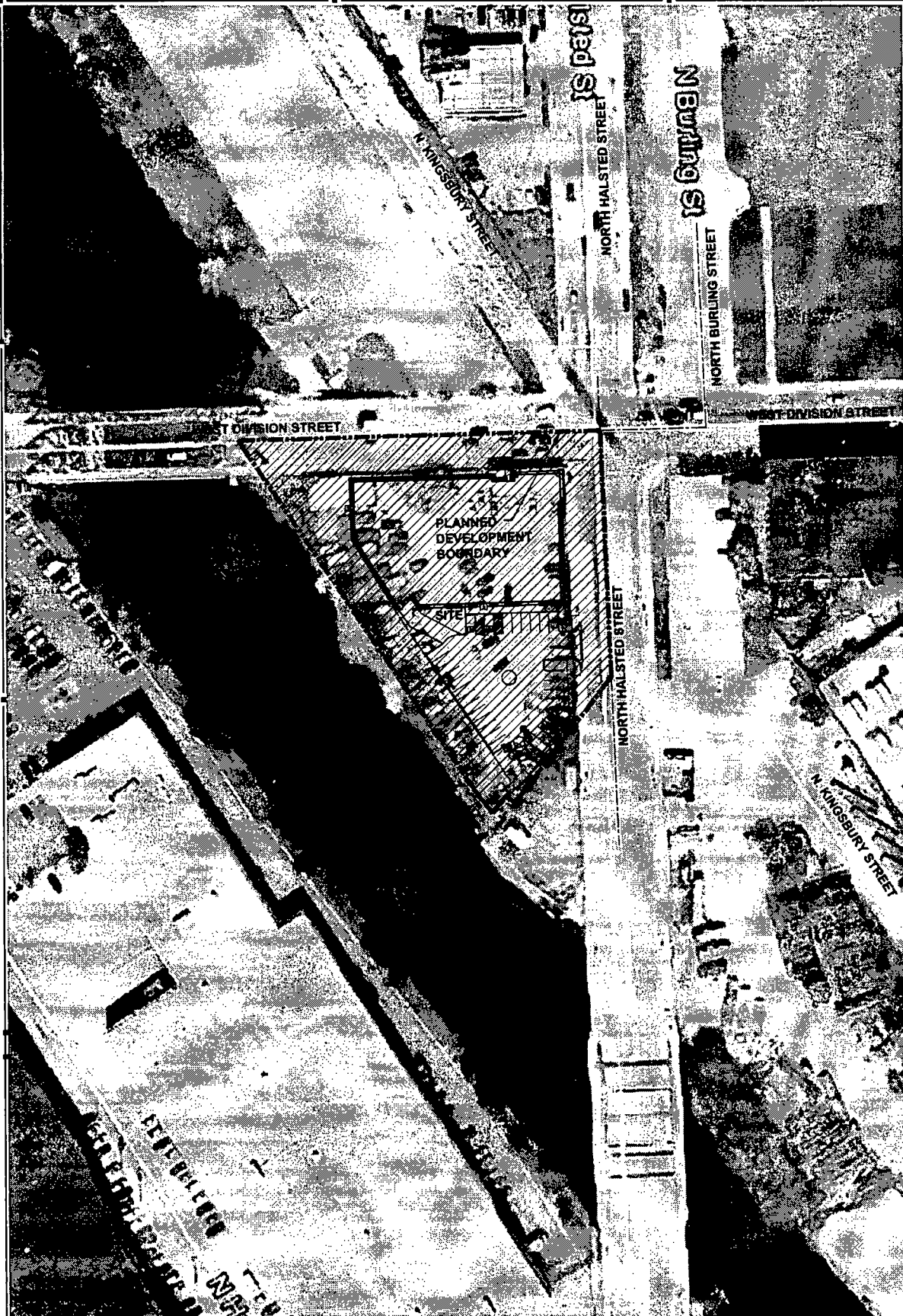

INTERPLANE

ARCHITECTURE
ENGINEERING
INTERIOR DESIGN
PROJECT
MANAGEMENT

AA 003420
CA 8660

ONE SOUTH 280
SUMMIT AVE SUITE D
OAKBROOK TERRACE, IL
60181
PH 630.932.2338
FX 630.932.2339

SEAL:

CONSULTANT

WT

W-T CIVIL ENGINEERING, LLC.
CIVIL AND STRUCTURAL ENGINEERING

3575 Paulina Avenue
Naperville, Illinois 60563
PH (630) 965-8222 FAX (630) 286-3666
WWW.WTENGINEERING.COM
LIC. NUMBER: 184-003247 Exp. 03/2015

REVISIONS:

NO	DATE	REMARKS
08-01-13	LOD	
10-09-13	PLANNED DEVELOPMENT	

InSite

West Marine
DIVISION ST & HALSTED ST
CHICAGO, IL

1150 Paulina Avenue
Naperville, IL 60563
PH (630) 965-8222 FAX (630) 286-3666
WWW.WTENGINEERING.COM

COPYRIGHT © 2013
INTERPLAN LLC RESERVES
COPYRIGHT & OTHER
RIGHTS RESTRICTING
THESE DOCUMENTS TO
THE ORIGINAL SITE OR
PURPOSE FOR WHICH
THEY WERE PREPARED.
REPRODUCTIONS, CHANGES
OR ASSIGNMENTS ARE
PROHIBITED.

PROJECT NO: 2013.0229
DATE

AERIAL
MAP
EX-1

AERIAL MAP

Applicant: Chicago, IL (1150 Halsted) LLC
Address: 1150-68 North Halsted
Introduction Date: October 16th, 2013

SCALE: NTS



CHECKED

INTERPLANE

ARCHITECTURE
ENGINEERING
INTERIOR DESIGN
PROJECT
MANAGEMENT

AA 003420
CA 8660

ONE SOUTH 280
SUMMIT AVE SUITE D
DANBROOK TERRACE, IL
60181
PH 630.932.2336
FX 630.932.2339

SEAL

CONSULTANT

WT

W-T CIVIL ENGINEERING, LLC
CIVIL AND STRUCTURAL ENGINEERS
225 Palm Avenue
Chicago, Illinois 60604
PH: (773) 233-7400 FAX: (773) 233-9114
www.wtengineering.com
T. License No. 184-00082 Exp. 09/2015

REVISIONS

NO	DATE	REMARKS
08-01-13	LOG	
10-09-13	PLANNED DEVELOPMENT	

Small vertical text on the right side of the map area.

West Marine
DIVISION ST. & HALSTED ST.
CHICAGO, IL

InSite

COPYRIGHT © 2013
INTERPLAN LLC RESERVES
COPYRIGHT & OTHER
RIGHTS RESTRICTING
THESE DOCUMENTS TO
THE ORIGINAL SITE OR
PURPOSE FOR WHICH
THEY WERE PREPARED.
REPRODUCTIONS, CHANGES
OR ASSIGNMENTS ARE
PROHIBITED

PROJECT NO. 2013 0229
DATE:

EXISTING
ZONING
MAP
EX-2



Zoning data reflects all ordinances passed
in the most recent City Council meeting
Copyright (c) 2011, City of Chicago

LEGEND

- C = COMMERCIAL
- M = MANUFACTURING
- PD = PLANNED DEVELOPMENT
- PMD = PLANNED MANUFACTURING DEVELOPMENT
- R = RESIDENTIAL

EXISTING ZONING MAP
Applicant: Chicago, IL (1150 Halsted) LLC
Address: 1150-68 North Halsted
Introduction Date: October 16th, 2013

SCALE: NTS



CH-FOKED

INTERPLAN

ARCHITECTURE
ENGINEERING
INTERIOR DESIGN
PROJECT
MANAGEMENT

AA 003420
CA 8660

ONE SOUTH 280
SUMMIT AVE SUITE D
OAKBROOK TERRACE, IL
60181
PH 630 932 2336
FX 630 932 2339

SEAL

CONSULTANT



W-T CIVIL ENGINEERING, LLC
CIVIL AND STRUCTURAL ENGINEERS

3075 Prichard Avenue
Highland Park, Illinois 60030
PH: (708) 398-0233 FAX: (708) 398-0444
www.wt-engineering.com
E-Contact No: 184-003493 Reg. #02014

REVISIONS.

NO	DATE	REMARKS
08-01-13	LOD	
10-09-13	PLANNED DEVELOPMENT	

Interplan, Inc. L.L.C.
1400 West Superior Street, Suite 200
Chicago, IL 60642
Tel: 630.677.2100 Fax: 630.677.2101
www.interplan.com

InSite

West Marine
DIVISION ST. & HALSTED ST
CHICAGO, IL

COPYRIGHT © 2013
INTERPLAN LLC RESERVES
COPYRIGHT & OTHER
RIGHTS RESTRICTING
THESE DOCUMENTS TO
THE ORIGINAL SITE OR
PURPOSE FOR WHICH
THEY WERE PREPARED.
REPRODUCTIONS, CHANGES
OR ASSIGNMENTS ARE
PROHIBITED.

PROJECT NO. 2013 0229
DATE.

PLANNED
DEVELOPMENT
BOUNDARY AND
PROPERTY LINE
MAP

EX-3

CHECKED

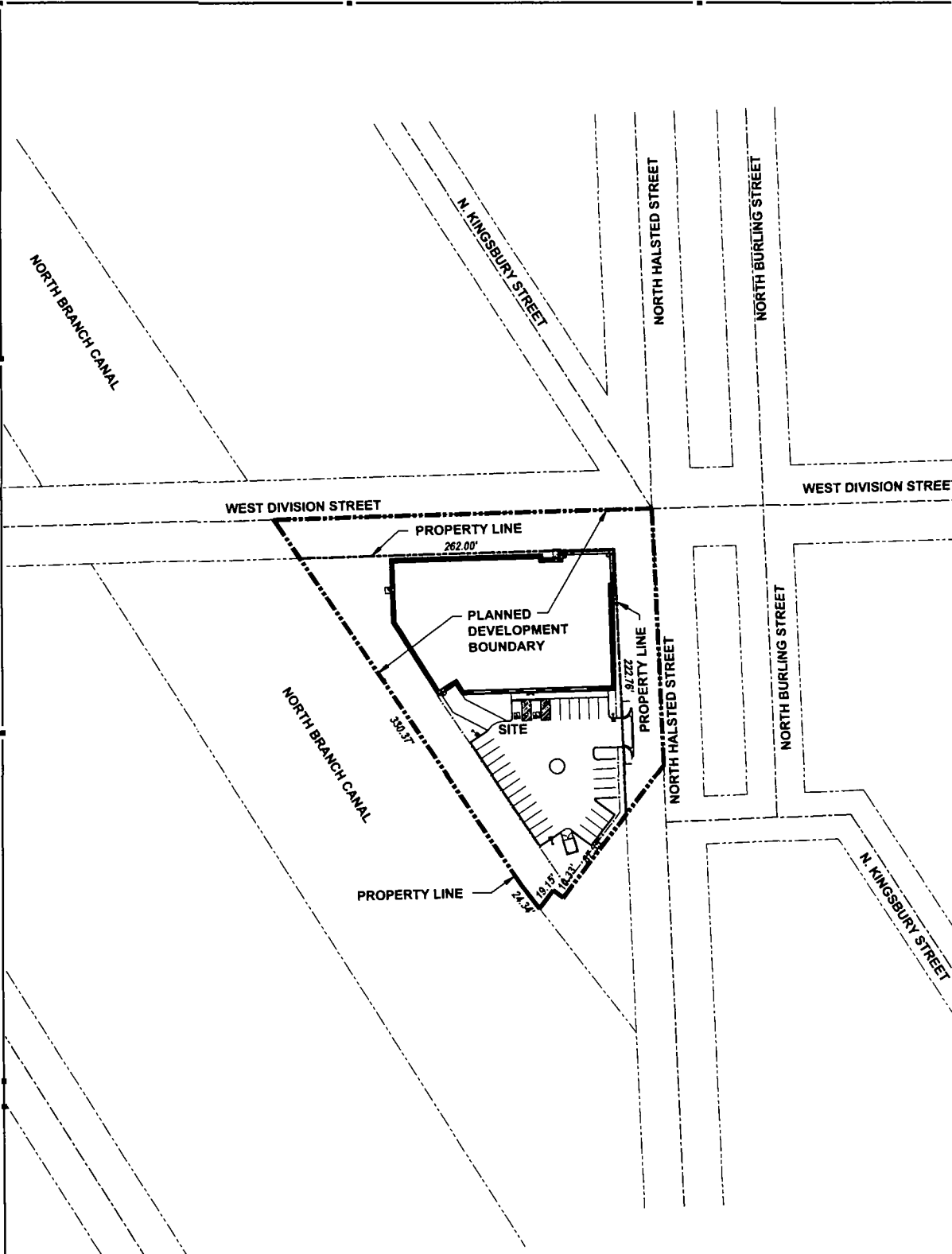

**PLANNED DEVELOPMENT BOUNDARY
AND PROPERTY LINE MAP**

Applicant: Chicago, IL (1150 Halsted) LLC
Address: 1150-68 North Halsted
Introduction Date: October 16th, 2013

SCALE: NTS



INTERPLANE

ARCHITECTURE
ENGINEERING
INTERIOR DESIGN
PROJECT
MANAGEMENT

AA 003420
CA 8860

ONE SOUTH 280
SUMMIT AVE SUITE D
OAKBROOK TERRACE, IL
60181
PH 630 932 2336
F X 630 932 2339

SEAL

CONSULTANT

WT

W-T CIVIL ENGINEERING, LLC
CIVIL AND STRUCTURAL ENGINEERS

2171 Power Avenue
Chicago, Illinois 60612
PH 312 251-5333 FAX 312 251-5344
www.wt-engineering.com
IL License No. 184-002482 Exp 09/2015

REVISIONS

NO	DATE	REMARKS
08-01-13	LOD	
10-09-13	PLANNED DEVELOPMENT	

Scale Date: 11/13
1:100 (As Shown) Date: 10/16/13
1:100 (As Shown) Date: 10/16/13
1:100 (As Shown) Date: 10/16/13

InSite

West Marine
DIVISION ST. & HALSTED ST
CHICAGO, IL

COPYRIGHT © 2013
INTERPLAN LLC RESERVES
COPYRIGHT & OTHER
RIGHTS RESTRICTING
THESE DOCUMENTS TO
THE ORIGINAL SITE OR
PURPOSE FOR WHICH
THEY WERE PREPARED.
REPRODUCTIONS, CHANGES
OR ASSIGNMENTS ARE
PROHIBITED

PROJECT NO. 2013 0229
DATE

EXISTING
LAND-USE
MAP
EX-4



SCALE NTS

CHECKED

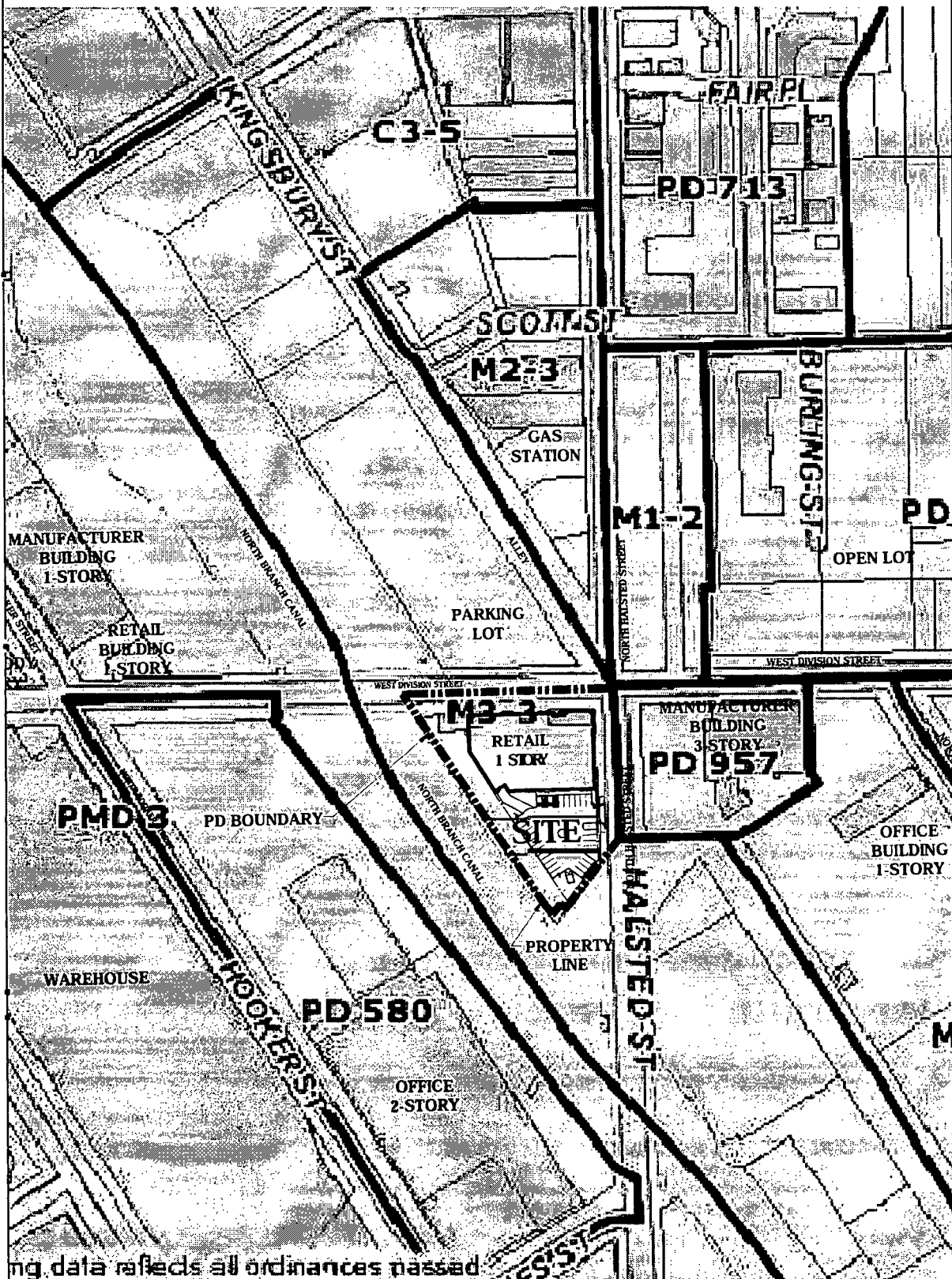

ing data reflects all ordinances passed

EXISTING LAND-USE MAP

Applicant: Chicago, IL (1150 Halsted) LLC
Address: 1150-68 North Halsted
Introduction Date: October 16th, 2013

INTERPLAN

ARCHITECTURE
ENGINEERING
INTERIOR DESIGN
PROJECT
MANAGEMENT

AA 003420
CA 8660

ONE SOUTH 280
SUMMIT AVE SUITE D
OAKBROOK TERRACE, IL
60181
PH 630 932 2336
FX 630 932 2339

SEAL

CONSULTANT

W-T

W-T CIVIL ENGINEERING, LLC

CIVIL AND STRUCTURAL ENGINEERING
3675 Piquette Avenue
Northbrook, Illinois 60062
PH: (708) 298-6333 FAX: (708) 298-6944
www.wt-engineering.com
E-MAIL: 184-02345@isp.com

REVISIONS.

NO	DATE	REMARKS
06	01-13	LDD
10	06-13	PLANNED DEVELOPMENT

West Marine
1150 North Halsted
Chicago, IL 60642
Tel: (773) 321-1100
www.westmarine.com

West Marine
DIVISION ST. & HALSTED ST.
CHICAGO, IL

InSite

COPYRIGHT © 2013
INTERPLAN LLC RESERVES
COPYRIGHT & OTHER
RIGHTS RESTRICTING
THESE DOCUMENTS TO
THE ORIGINAL SITE OR
PURPOSE FOR WHICH
THEY WERE PREPARED.
REPRODUCTIONS, CHANGES
OR ASSIGNMENTS ARE
PROHIBITED.

PROJECT NO: 2013 0229
DATE:

LANDSCAPE
PLAN
L-1

CHECKED:

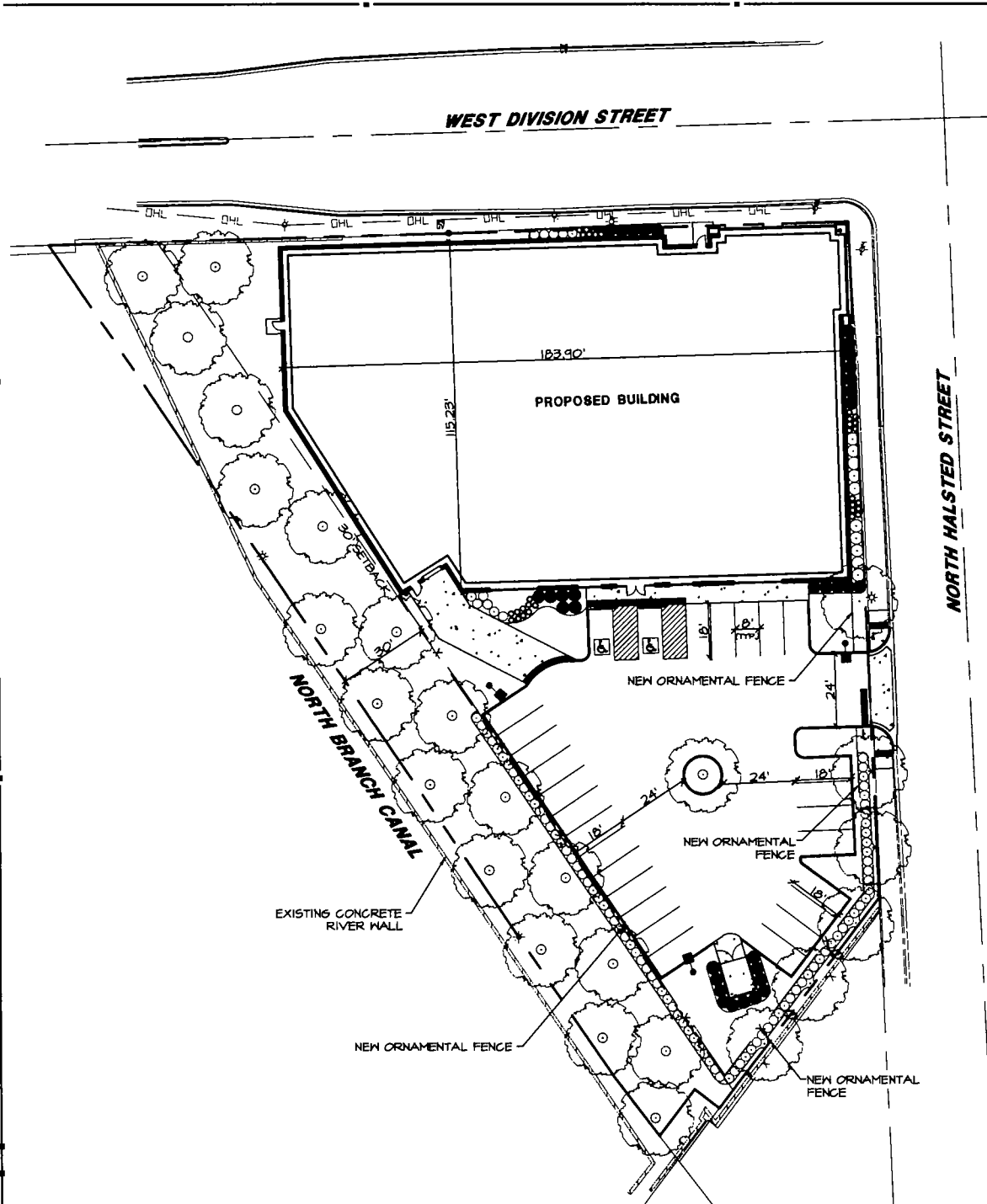

Legend



Deciduous Shade Tree (Typ.)

Deciduous Shrub (Typ.)

Evergreen Shrub (Typ.)

Perennial (Typ.)

LANDSCAPE PLAN

Applicant: Chicago, IL (1150 Halsted) LLC
Address: 1150-68 North Halsted
Introduction Date: October 16th, 2013

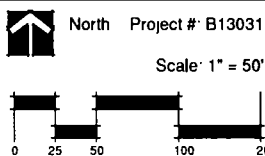

BDG
Brusseau Design Group, LLC
Landscape Architecture • Land Planning • Recreational Planning & Design
2675 Pratum Avenue, Hoffman Estates, IL 60192
(224) 293-6470 (224) 293-6477 Fax



Expires August 31, 2013

INTERPLAN

ARCHITECTURE
ENGINEERING
INTERIOR DESIGN
PROJECT
MANAGEMENT

AA 003420
CA 8660

ONE SOUTH 280
SUMMIT AVE SUITE D
OAKBROOK TERRACE, IL
60181
PH 630 932 2336
FX 630 932 2339

SEAL

CONSULTANT:

W-T

W-T CIVIL ENGINEERING, LLC
CIVIL AND STRUCTURAL ENGINEERING
3175 Truman Avenue
Northbrook, Illinois 60062
PH (708) 963-8443 FAX (708) 298-0444
www.wt-engineering.com
IL License No. 184-022482 Exp. 04/2015

REVISIONS:

NO	DATE	REMARKS
08-01	13	LOD
10-09	13	PLANNED DEVELOPMENT

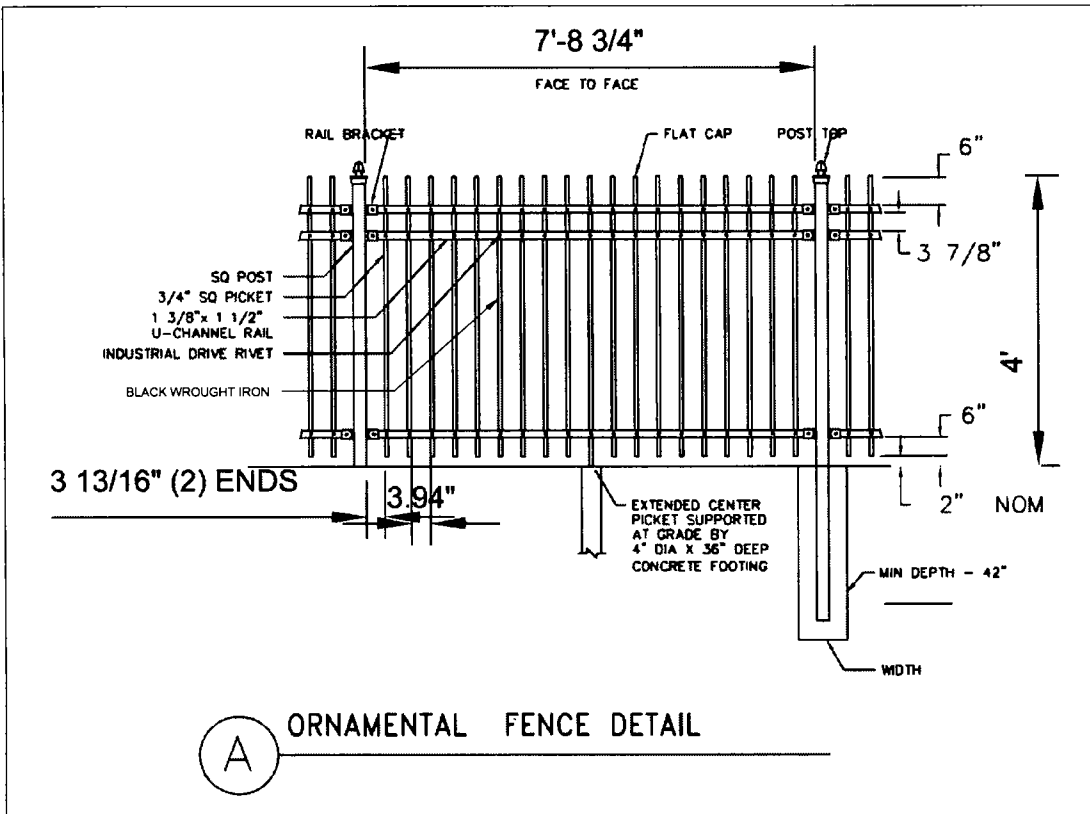

IN-SITE LANDSCAPE ARCHITECTURE, LLC
 1150-68 NORTH HALSTED ST. CHICAGO, IL 60641-3415
 T. 773.571.7122 F. 773.571.7123 www.in-site.com

West Marine
 DIVISION ST. & HALSTED ST.
 CHICAGO, IL

InSite

COPYRIGHT © 2013
INTERPLAN LLC RESERVES
COPYRIGHT & OTHER
RIGHTS RESTRICTING
THESE DOCUMENTS TO
THE ORIGINAL SITE OR
PURPOSE FOR WHICH
THEY WERE PREPARED.
REPRODUCTIONS, CHANGES
OR ASSIGNMENTS ARE
PROHIBITED

PROJECT NO 2013 0229
DATE:



Signature

Expires Aug. 31, 2015

FENCE DETAIL
Applicant: Chicago, IL (1150 Halsted) LLC
Address: 1150-68 North Halsted
Introduction Date: October 16th, 2013

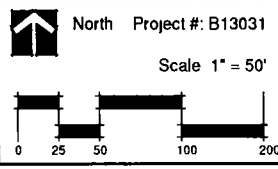

BDG
Brusseau Design Group, LLC
Landscape Architecture • Land Planning • Recreational Planning & Design
2675 Pralum Avenue, Hoffman Estates, IL 60182
(224) 293-8470 (224) 293-8477 Fax

FENCE
DETAIL
L-2
CHECKED

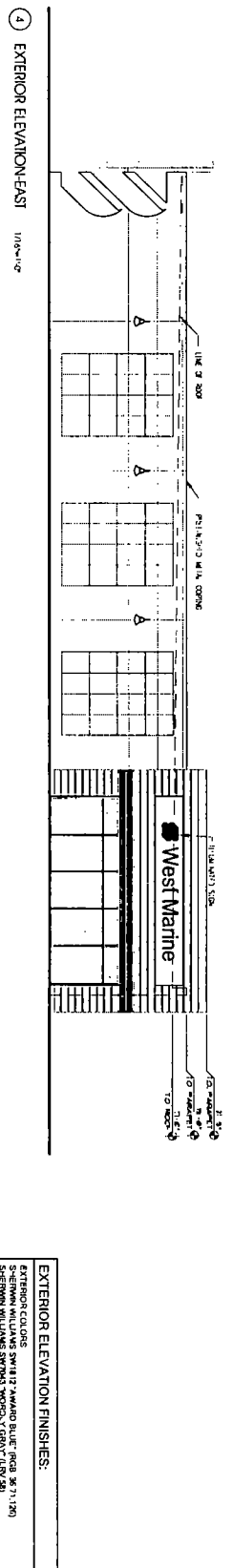
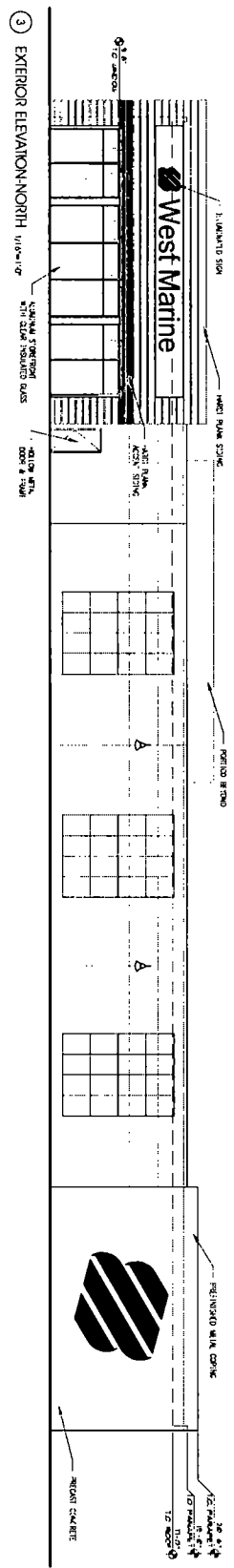
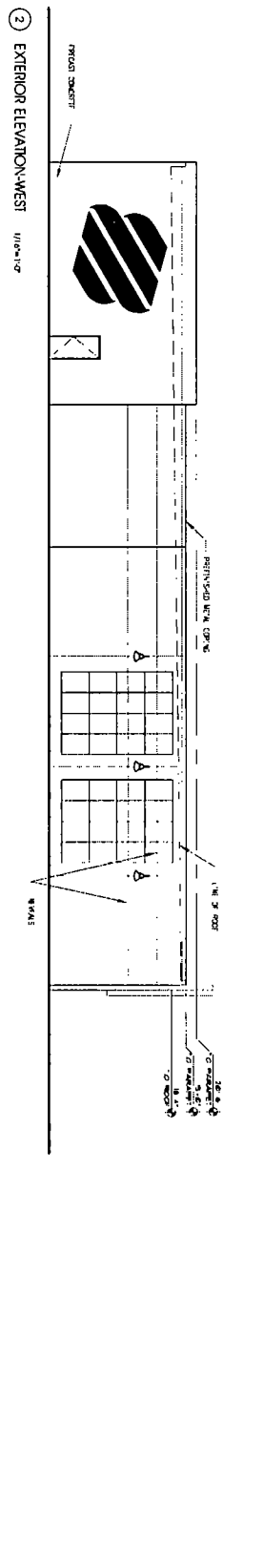
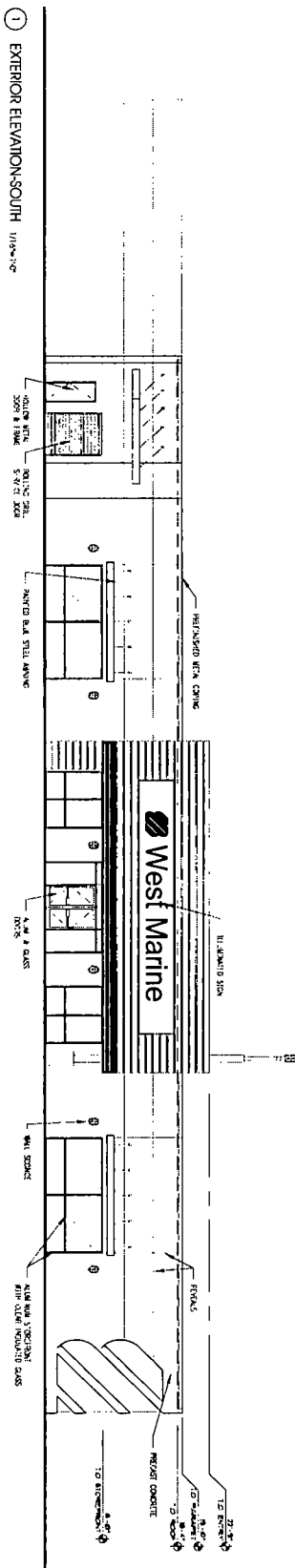

ELEVATIONS SCALE: 1/8" = 1'-0"

Applicant: Chicago, IL (1150 Halsted) LLC
 Address: 1150-68 North Halsted
 Introduction Date: October 14th, 2013

EXTERIOR ELEVATION FINISHES:

STAINLESS STEEL
 SHERWIN WILLIAMS SWH112 "AMARDO BLUE" (PGB 3671.120)
 SHERWIN WILLIAMS SWH112 "GRAY" (LIV 50)
 PAINTED STEEL TRUSS
 SHERWIN WILLIAMS SWH112 "BLACK FOX" (LIV 8)
 HARDI PLANK SERRA
 SHERWIN WILLIAMS SWH112 "BURNISHED BRASS" (LIV 11)
 SHERWIN WILLIAMS SWH112 "AMARDO BLUE" (ACCENT)

<p>INTOR-LANE</p> <p>ARCHITECTURE 1150 N. HALSTED ST. CHICAGO, IL 60642 TEL: 312.467.1111 WWW.INTOR-LANE.COM</p>	<p>WEST</p> <p>WEST MARINE 1150 N. HALSTED ST. CHICAGO, IL 60642 TEL: 312.467.1111 WWW.WESTMARINE.COM</p>	<p>InSite</p> <p>West Marine 1150 N. HALSTED ST. CHICAGO, IL 60642 TEL: 312.467.1111 WWW.WESTMARINE.COM</p>	<p>PROJECT NO. 2013.03 DATE: 10/14/13 DRAWING NO. EX-6</p>
---	--	--	--

GREEN ROOF PLAN SCALE 3/16"=1'-0"
 Applicant: Chicago, IL (1150 Hobstead) LLC
 Address: 1150-68 North Halsted
 Introduction Date: October 16th, 2013



PROPOSED GREEN ROOF
 NON-USABLE CLEARANCE



GREEN ROOF:
 NET ROOF AREA: 16,346 SF
 GREEN ROOF AREA: 14,182 SF
 PERCENTAGE OF VEGETATIVE COVER: 86% OF NET ROOF AREA
 PERCENTAGE OF VEGETATIVE COVER: 86% OF GREEN ROOF AREA
 SWATH'S SWATH CLEARANCES: 1,428 SF
 HARD SCAPE ACCESS AREAS: 3,114 SF (UP TO 10% OF GREEN ROOF AREA ALLOWED)

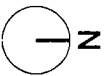

<p>INTERPLANS ARCHITECTURE 4400 N. LA SALLE CHICAGO, IL 60640 PROJECT MANAGER 4400 N. LA SALLE CHICAGO, IL 60640</p>	<p>WEST MARINE 1150-68 NORTH HALSTED CHICAGO, IL 60642 312.467.1111 WWW.WESTMARINE.COM</p>	<p>InSite West Marine Harold H. & Debra B. Chicago, IL</p>	<p>CONTRACT NO. 2012127 DATE: 10/16/13 PROJECT NO. 2012127 SHEET: EX-7</p>
---	---	---	---