



Office of the Chicago City
Clerk



O2011-6331

Office of the City Clerk

City Council Document Tracking Sheet

Meeting Date:	7/28/2011
Sponsor(s):	City Clerk Mendoza
Type:	Ordinance
Title:	Zoning Reclassification App No. 17310
Committee(s) Assignment:	Committee on Zoning, Landmarks and Building Standards

ORDINANCE

BE IT ORDAINED BY THE CITY COUNCIL OF THE CITY OF CHICAGO:

SECTION 1. Title 17 of the Municipal Code of Chicago, the Chicago Zoning Ordinance, is hereby amended by changing all of the RM5 Residential Multi-Unit District symbols and indications as shown on Map No. 12-D in the area bounded by

East 52nd Street; South Harper Avenue; a line 75 feet south of and parallel to East 52nd Street; a line 150 feet west of and parallel to South Harper Avenue,

to those of a B2-3 Neighborhood Mixed-Use District.

SECTION 2. This ordinance takes effect after its passage and approval.

Common Address of Property: 5200 S. Harper

CITY OF CHICAGO

APPLICATION FOR AN AMENDMENT TO
THE CHICAGO ZONING ORDINANCE

17310
INT. DATE:
7-28-11

1. ADDRESS of the property Applicant is seeking to rezone:

5200 S. HARPER, CHICAGO, IL 60615

2. Ward Number that property is located in: 4th

3. APPLICANT 5200 HARPER APT, LLC.

ADDRESS P.O. BOX 4047 CITY NAPERVILLE

STATE IL ZIP CODE 60567 PHONE 312-656-5065

EMAIL laki_wj@yahoo.com CONTACT PERSON LAKI NIKOKAYOURAS

4. Is the applicant the owner of the property? YES NO
If the applicant is not the owner of the property, please provide the following information regarding the owner and attach written authorization from the owner allowing the application to proceed.

OWNER 5200 HARPER APT, LLC.

ADDRESS P.O. BOX 4047 CITY NAPERVILLE

STATE IL ZIP CODE 60567 PHONE 773-919-8880

EMAIL _____ CONTACT PERSON LOUIS NATSAR

5. If the Applicant/Owner of the property has obtained a lawyer as their representative for the rezoning, please provide the following information:

ATTORNEY _____

ADDRESS _____

CITY _____ STATE _____ ZIP CODE _____

PHONE _____ FAX _____ EMAIL _____

6. If the applicant is a legal entity (Corporation, LLC, Partnership, etc.) please provide the names of all owners as disclosed on the Economic Disclosure Statements.

LOUIS NAJJAR

7. On what date did the owner acquire legal title to the subject property? MAR. 18, 2010

8. Has the present owner previously rezoned this property? If yes, when?

NO

9. Present Zoning District RM-5 Proposed Zoning District B2-3

10. Lot size in square feet (or dimensions) 150' x 75' = 11,250 sq ft

11. Current Use of the property RESIDENTIAL & COMMERCIAL

12. Reason for rezoning the property 2 COMMERCIAL UNITS HAVE NOT BEEN OCCUPIED FOR OVER 10 MONTHS, HENCE A BUSINESS LICENCE WILL NOT BE GRANTED/DENIED DUE TO THE CURRENT RM-5 ZONING.

13. Describe the proposed use of the property after the rezoning. Indicate the number of dwelling units; number of parking spaces; approximate square footage of any commercial space; and height of the proposed building. (BE SPECIFIC)

THE PROPERTY SHALL REMAIN WITH 44 RESIDENTIAL UNITS. CURRENTLY THERE ARE NO PARKING SPACES AND NONE SHALL BE ADDED. THERE ARE CURRENTLY THREE COMMERCIAL SPACES WHICH WILL BE INCREASED TO FIVE RETAIL AND OR OFFICE SPACES. THE SQUARE FOOTAGE PER SPACE IS: SPACE 1 (1,300 SF), SPACE 2 (2,000 SF), SPACE 3 (1,100 SF), SPACE 4 (800 SF), SPACE 5 (1,100 SF)

14. On May 14th, 2007, the Chicago City Council passed the Affordable Requirements Ordinance (ARO) that requires on-site affordable housing units or a financial contribution if residential housing projects receive a zoning change under certain circumstances. Based on the lot size of the project in question and the proposed zoning classification, is this project subject to the Affordable Requirements Ordinance? (See Fact Sheet for more information)

YES _____ NO ✓

COUNTY OF COOK
STATE OF ILLINOIS

5200 HARPER APT. LLC
c/o LOUIS NAJJAR

_____, being first duly sworn on oath, states that all of the above statements and the statements contained in the documents submitted herewith are true and correct.

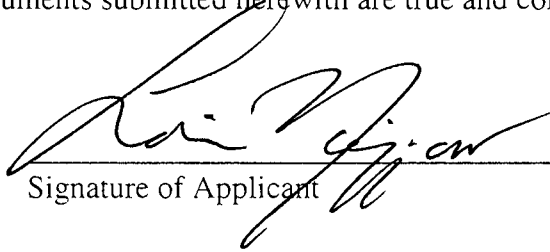

Signature of Applicant

Subscribed and Sworn to before me this
28th day of JUNE, 20 11.



Notary Public

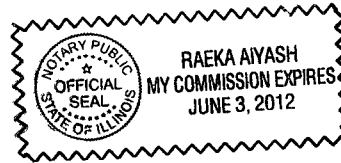

For Office Use Only

Date of Introduction: _____

File Number: _____

Ward: _____

"WRITTEN NOTICE"
FORM OF AFFIDAVIT
(Section 17-13-0107)

Date

Honorable Daniel S. Solis
Chairman, Committee on Zoning
121 North LaSalle Street
Room 304, City Hall
Chicago, Illinois 60602

The undersigned, 5200 HARPER APT. LLC c/o LOUIS NAJJAR being first duly sworn on oath deposes and states the following:

The undersigned certifies that he has complied with the requirements of Section 17-13-0107 of the Chicago Zoning Ordinance, by sending written notice to such property owners who appear to be the owners of the property within the subject area not solely owned by the applicant, and to the owners of all property within 250 feet in each direction of the lot line of the subject property, exclusive of public roads, streets, alleys and other public ways, or a total distance limited to 400 feet. Said "written notice" was sent by First Class U.S. Mail, no more than 30 days before filing the application.

The undersigned certifies that the notice contained the address of the property sought to be rezoned; a statement of the intended use of the property; the name and address of the applicant; the name and address of the owner; and a statement that the applicant intends to file the application for a change in zoning on approximately {INSERT DATE}. 27 JULY 2011

The undersigned certifies that the applicant has made a bona fide effort to determine the addresses of the parties to be notified under Section 17-13-0107 of the Chicago Zoning Ordinance, and that the accompanying list of names and addresses of surrounding property owners within 250 feet of the subject site is a complete list containing the names and addresses of the people required to be served.

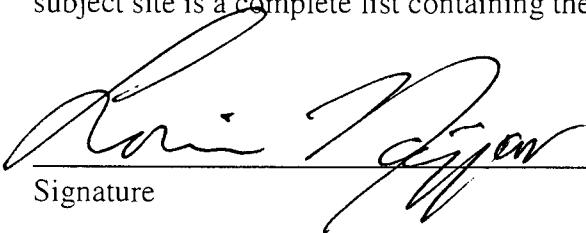

Signature

Subscribed and Sworn to before me this
28th day of JUNE, 20 11



Notary Public

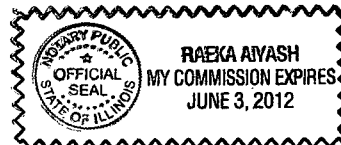

30 June 2011

Dear Property Owner,

In accordance with the requirements for an Amendment to the Chicago Zoning Ordinance, specifically Section 17-13-0107, please be informed that on or about 30 June 2011, the undersigned will file an application for a change in zoning from RM-5 to B2-3 on behalf of 5200 Harper Apt, LLC for the property located at 5200 S. Harper Apartments, LLC, Chicago, IL 60615.

The applicant intends to use the subject property for 44 residential units and 5 retail and or office spaces. The property is approximately 6453sf per floor.

5200 Harper Apartments, LLC is located at P.O. Box 4047, Naperville, IL 60567. The contact person for this application is Laki Nikokavouras, P.O. Box 4047, Naperville, IL 60567, 773.287.9999.

Please note that the applicant is not seeking to rezone or purchase your property. The applicant is required by law to send this notice because you own the property within 250 feet of the property to be rezoned.

Very truly yours,

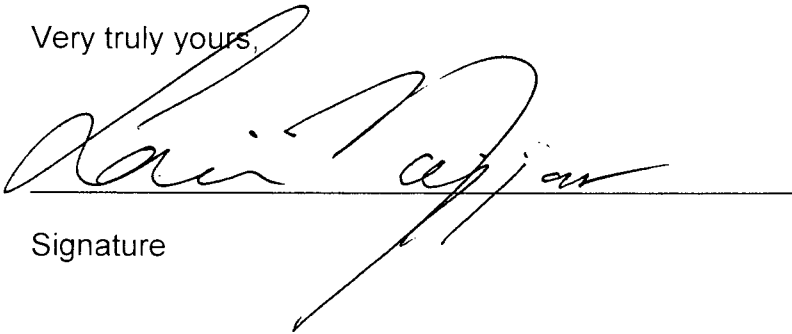
A handwritten signature in black ink, appearing to read "Laki Nikokavouras", is written over a horizontal line. The signature is fluid and cursive, with a long, sweeping underline that extends to the right.

Signature

**CITY OF CHICAGO
ECONOMIC DISCLOSURE STATEMENT
AND AFFIDAVIT**

SECTION I -- GENERAL INFORMATION

A. Legal name of the Disclosing Party submitting this EDS. Include d/b/a/ if applicable:

5200 HARPER APT, LLC

Check ONE of the following three boxes:

Indicate whether the Disclosing Party submitting this EDS is:

1. the Applicant

OR

2. a legal entity holding a direct or indirect interest in the Applicant. State the legal name of the Applicant in which the Disclosing Party holds an interest: _____

OR

3. a legal entity with a right of control (see Section II.B.1.) State the legal name of the entity in which the Disclosing Party holds a right of control: _____

B. Business address of the Disclosing Party: P.O. BOX 4047
NAPERVILLE, IL 60567

C. Telephone: 773-919-8880 Fax: _____ Email: _____

D. Name of contact person: LOUIS NAJJAR

E. Federal Employer Identification No. (if you have one): NA

F. Brief description of contract, transaction or other undertaking (referred to below as the "Matter") to which this EDS pertains. (Include project number and location of property, if applicable):

REZONING FROM RM-5 to B2-3 AT 5200 S. HARPER ST., CHICAGO, IL 60615

G. Which City agency or department is requesting this EDS? ZONING

If the Matter is a contract being handled by the City's Department of Procurement Services, please complete the following:

Specification # _____ and Contract # _____

SECTION II -- DISCLOSURE OF OWNERSHIP INTERESTS

A. NATURE OF THE DISCLOSING PARTY

1. Indicate the nature of the Disclosing Party:

- Person
- Limited liability company
- Publicly registered business corporation
- Limited liability partnership
- Privately held business corporation
- Joint venture
- Sole proprietorship
- Not-for-profit corporation
- General partnership
- (Is the not-for-profit corporation also a 501(c)(3))?
- Limited partnership
- Yes No
- Trust
- Other (please specify)

2. For legal entities, the state (or foreign country) of incorporation or organization, if applicable:

ILLINOIS

3. For legal entities not organized in the State of Illinois: Has the organization registered to do business in the State of Illinois as a foreign entity?

- Yes
- No
- N/A

B. IF THE DISCLOSING PARTY IS A LEGAL ENTITY:

1. List below the full names and titles of all executive officers and all directors of the entity.

NOTE: For not-for-profit corporations, also list below all members, if any, which are legal entities. If there are no such members, write "no members." For trusts, estates or other similar entities, list below the legal titleholder(s).

If the entity is a general partnership, limited partnership, limited liability company, limited liability partnership or joint venture, list below the name and title of each general partner, managing member, manager or any other person or entity that controls the day-to-day management of the Disclosing Party.

NOTE: Each legal entity listed below must submit an EDS on its own behalf.

Name	Title
<u>LOUIS NAJJAR</u>	<u>MEMBER</u>

2. Please provide the following information concerning each person or entity having a direct or indirect beneficial interest (including ownership) in excess of 7.5% of the Disclosing Party. Examples of such an interest include shares in a corporation, partnership interest in a partnership or joint venture,

interest of a member or manager in a limited liability company, or interest of a beneficiary of a trust, estate or other similar entity. If none, state "None." **NOTE:** Pursuant to Section 2-154-030 of the Municipal Code of Chicago ("Municipal Code"), the City may require any such additional information from any applicant which is reasonably intended to achieve full disclosure.

Name	Business Address	Percentage Interest in the Disclosing Party
LOUIS NAJJAR	P.O. BOX 4047 NAPERVILLE, IL 60567	100%

SECTION III -- BUSINESS RELATIONSHIPS WITH CITY ELECTED OFFICIALS

Has the Disclosing Party had a "business relationship," as defined in Chapter 2-156 of the Municipal Code, with any City elected official in the 12 months before the date this EDS is signed?

Yes No

If yes, please identify below the name(s) of such City elected official(s) and describe such relationship(s):

SECTION IV -- DISCLOSURE OF SUBCONTRACTORS AND OTHER RETAINED PARTIES

The Disclosing Party must disclose the name and business address of each subcontractor, attorney, lobbyist, accountant, consultant and any other person or entity whom the Disclosing Party has retained or expects to retain in connection with the Matter, as well as the nature of the relationship, and the total amount of the fees paid or estimated to be paid. The Disclosing Party is not required to disclose employees who are paid solely through the Disclosing Party's regular payroll.

“Lobbyist” means any person or entity who undertakes to influence any legislative or administrative action on behalf of any person or entity other than: (1) a not-for-profit entity, on an unpaid basis, or (2) himself. “Lobbyist” also means any person or entity any part of whose duties as an employee of another includes undertaking to influence any legislative or administrative action.

If the Disclosing Party is uncertain whether a disclosure is required under this Section, the Disclosing Party must either ask the City whether disclosure is required or make the disclosure.

Name (indicate whether retained or anticipated to be retained)	Business Address	Relationship to Disclosing Party (subcontractor, attorney, lobbyist, etc.)	Fees (indicate whether paid or estimated.) NOTE: "hourly rate" or "t.b.d." is not an acceptable response.
--	------------------	--	--

NONE

(Add sheets if necessary)

Check here if the Disclosing Party has not retained, nor expects to retain, any such persons or entities.

SECTION V -- CERTIFICATIONS

A. COURT-ORDERED CHILD SUPPORT COMPLIANCE

Under Municipal Code Section 2-92-415, substantial owners of business entities that contract with the City must remain in compliance with their child support obligations throughout the contract's term.

Has any person who directly or indirectly owns 10% or more of the Disclosing Party been declared in arrearage on any child support obligations by any Illinois court of competent jurisdiction?

Yes No No person directly or indirectly owns 10% or more of the Disclosing Party.

If "Yes," has the person entered into a court-approved agreement for payment of all support owed and is the person in compliance with that agreement?

Yes No

B. FURTHER CERTIFICATIONS

1. Pursuant to Municipal Code Chapter 1-23, Article I ("Article I")(which the Applicant should consult for defined terms (e.g., "doing business") and legal requirements), if the Disclosing Party submitting this EDS is the Applicant and is doing business with the City, then the Disclosing Party certifies as follows: (i) neither the Applicant nor any controlling person is currently indicted or charged with, or has admitted guilt of, or has ever been convicted of, or placed under supervision for, any criminal offense involving actual, attempted, or conspiracy to commit bribery, theft, fraud, forgery, perjury, dishonesty or deceit against an officer or employee of the City or any sister agency; and (ii) the Applicant understands and acknowledges that compliance with Article I is a continuing requirement for doing business with the City. NOTE: If Article 1 applies to the Applicant, the permanent compliance timeframe in Article I supersedes some five-year compliance timeframes in certifications 2 and 3 below.

2. The Disclosing Party and, if the Disclosing Party is a legal entity, all of those persons or entities identified in Section II.B.1. of this EDS:

- a. are not presently debarred, suspended, proposed for debarment, declared ineligible or voluntarily excluded from any transactions by any federal, state or local unit of government;
- b. have not, within a five-year period preceding the date of this EDS, been convicted of a criminal offense, adjudged guilty, or had a civil judgment rendered against them in connection with: obtaining, attempting to obtain, or performing a public (federal, state or local) transaction or contract under a public transaction; a violation of federal or state antitrust statutes; fraud; embezzlement; theft; forgery; bribery; falsification or destruction of records; making false statements; or receiving stolen property;
- c. are not presently indicted for, or criminally or civilly charged by, a governmental entity (federal, state or local) with committing any of the offenses set forth in clause B.2.b. of this Section V;
- d. have not, within a five-year period preceding the date of this EDS, had one or more public transactions (federal, state or local) terminated for cause or default; and
- e. have not, within a five-year period preceding the date of this EDS, been convicted, adjudged guilty, or found liable in a civil proceeding, or in any criminal or civil action, including actions concerning environmental violations, instituted by the City or by the federal government, any state, or any other unit of local government.

3. The certifications in subparts 3, 4 and 5 concern:

- the Disclosing Party;
- any "Contractor" (meaning any contractor or subcontractor used by the Disclosing Party in connection with the Matter, including but not limited to all persons or legal entities disclosed under Section IV, "Disclosure of Subcontractors and Other Retained Parties");
- any "Affiliated Entity" (meaning a person or entity that, directly or indirectly: controls the Disclosing Party, is controlled by the Disclosing Party, or is, with the Disclosing Party, under common control of another person or entity. Indicia of control include, without limitation: interlocking management or ownership; identity of interests among family members, shared facilities and equipment; common use of employees; or organization of a business entity following the ineligibility of a business entity to do business with federal or state or local government, including the City, using substantially the same management, ownership, or principals as the ineligible entity); with respect to Contractors, the term Affiliated Entity means a person or entity that directly or indirectly controls the Contractor, is controlled by it, or, with the Contractor, is under common control of another person or entity;
- any responsible official of the Disclosing Party, any Contractor or any Affiliated Entity or any other official, agent or employee of the Disclosing Party, any Contractor or any Affiliated Entity, acting pursuant to the direction or authorization of a responsible official of the Disclosing Party, any Contractor or any Affiliated Entity (collectively "Agents").

Neither the Disclosing Party, nor any Contractor, nor any Affiliated Entity of either the Disclosing Party or any Contractor nor any Agents have, during the five years before the date this EDS is signed, or, with respect to a Contractor, an Affiliated Entity, or an Affiliated Entity of a Contractor during the five years before the date of such Contractor's or Affiliated Entity's contract or engagement in connection with the Matter:

- a. bribed or attempted to bribe, or been convicted or adjudged guilty of bribery or attempting to bribe, a public officer or employee of the City, the State of Illinois, or any agency of the federal government or of any state or local government in the United States of America, in that officer's or employee's official capacity;
- b. agreed or colluded with other bidders or prospective bidders, or been a party to any such agreement, or been convicted or adjudged guilty of agreement or collusion among bidders or prospective bidders, in restraint of freedom of competition by agreement to bid a fixed price or otherwise; or
- c. made an admission of such conduct described in a. or b. above that is a matter of record, but have not been prosecuted for such conduct; or
- d. violated the provisions of Municipal Code Section 2-92-610 (Living Wage Ordinance).

4. Neither the Disclosing Party, Affiliated Entity or Contractor, or any of their employees, officials, agents or partners, is barred from contracting with any unit of state or local government as a result of engaging in or being convicted of (1) bid-rigging in violation of 720 ILCS 5/33E-3; (2) bid-rotating in violation of 720 ILCS 5/33E-4; or (3) any similar offense of any state or of the United States of America that contains the same elements as the offense of bid-rigging or bid-rotating.

5. Neither the Disclosing Party nor any Affiliated Entity is listed on any of the following lists maintained by the Office of Foreign Assets Control of the U.S. Department of the Treasury or the Bureau of Industry and Security of the U.S. Department of Commerce or their successors: the Specially Designated Nationals List, the Denied Persons List, the Unverified List, the Entity List and the Debarred List.

6. The Disclosing Party understands and shall comply with the applicable requirements of Chapters 2-55 (Legislative Inspector General), 2-56 (Inspector General) and 2-156 (Governmental Ethics) of the Municipal Code.

7. If the Disclosing Party is unable to certify to any of the above statements in this Part B (Further Certifications), the Disclosing Party must explain below:

If the letters "NA," the word "None," or no response appears on the lines above, it will be conclusively presumed that the Disclosing Party certified to the above statements.

C. CERTIFICATION OF STATUS AS FINANCIAL INSTITUTION

1. The Disclosing Party certifies that the Disclosing Party (check one)

is is not

a "financial institution" as defined in Section 2-32-455(b) of the Municipal Code.

2. If the Disclosing Party IS a financial institution, then the Disclosing Party pledges:

"We are not and will not become a predatory lender as defined in Chapter 2-32 of the Municipal Code. We further pledge that none of our affiliates is, and none of them will become, a predatory lender as defined in Chapter 2-32 of the Municipal Code. We understand that becoming a predatory lender or becoming an affiliate of a predatory lender may result in the loss of the privilege of doing business with the City."

If the Disclosing Party is unable to make this pledge because it or any of its affiliates (as defined in Section 2-32-455(b) of the Municipal Code) is a predatory lender within the meaning of Chapter 2-32 of the Municipal Code, explain here (attach additional pages if necessary):

If the letters "NA," the word "None," or no response appears on the lines above, it will be conclusively presumed that the Disclosing Party certified to the above statements.

D. CERTIFICATION REGARDING INTEREST IN CITY BUSINESS

Any words or terms that are defined in Chapter 2-156 of the Municipal Code have the same meanings when used in this Part D.

1. In accordance with Section 2-156-110 of the Municipal Code: Does any official or employee of the City have a financial interest in his or her own name or in the name of any other person or entity in the Matter?

Yes No

NOTE: If you checked "Yes" to Item D.1., proceed to Items D.2. and D.3. If you checked "No" to Item D.1., proceed to Part E.

2. Unless sold pursuant to a process of competitive bidding, or otherwise permitted, no City elected official or employee shall have a financial interest in his or her own name or in the name of any other person or entity in the purchase of any property that (i) belongs to the City, or (ii) is sold for taxes or assessments, or (iii) is sold by virtue of legal process at the suit of the City (collectively, "City Property Sale"). Compensation for property taken pursuant to the City's eminent domain power does not constitute a financial interest within the meaning of this Part D.

Does the Matter involve a City Property Sale?

Yes

No

3. If you checked "Yes" to Item D.1., provide the names and business addresses of the City officials or employees having such interest and identify the nature of such interest:

Name	Business Address	Nature of Interest

4. The Disclosing Party further certifies that no prohibited financial interest in the Matter will be acquired by any City official or employee.

E. CERTIFICATION REGARDING SLAVERY ERA BUSINESS

Please check either 1. or 2. below. If the Disclosing Party checks 2., the Disclosing Party must disclose below or in an attachment to this EDS all information required by paragraph 2. Failure to comply with these disclosure requirements may make any contract entered into with the City in connection with the Matter voidable by the City.

1. The Disclosing Party verifies that the Disclosing Party has searched any and all records of the Disclosing Party and any and all predecessor entities regarding records of investments or profits from slavery or slaveholder insurance policies during the slavery era (including insurance policies issued to slaveholders that provided coverage for damage to or injury or death of their slaves), and the Disclosing Party has found no such records.

2. The Disclosing Party verifies that, as a result of conducting the search in step 1 above, the Disclosing Party has found records of investments or profits from slavery or slaveholder insurance policies. The Disclosing Party verifies that the following constitutes full disclosure of all such records, including the names of any and all slaves or slaveholders described in those records:

SECTION VI -- CERTIFICATIONS FOR FEDERALLY FUNDED MATTERS

NOTE: If the Matter is federally funded, complete this Section VI. If the Matter is not federally funded, proceed to Section VII. For purposes of this Section VI, tax credits allocated by the City and proceeds of debt obligations of the City are not federal funding.

A. CERTIFICATION REGARDING LOBBYING

1. List below the names of all persons or entities registered under the federal Lobbying Disclosure Act of 1995 who have made lobbying contacts on behalf of the Disclosing Party with respect to the Matter: (Add sheets if necessary):

NONE

(If no explanation appears or begins on the lines above, or if the letters "NA" or if the word "None" appear, it will be conclusively presumed that the Disclosing Party means that NO persons or entities registered under the Lobbying Disclosure Act of 1995 have made lobbying contacts on behalf of the Disclosing Party with respect to the Matter.)

2. The Disclosing Party has not spent and will not expend any federally appropriated funds to pay any person or entity listed in Paragraph A.1. above for his or her lobbying activities or to pay any person or entity to influence or attempt to influence an officer or employee of any agency, as defined by applicable federal law, a member of Congress, an officer or employee of Congress, or an employee of a member of Congress, in connection with the award of any federally funded contract, making any federally funded grant or loan, entering into any cooperative agreement, or to extend, continue, renew, amend, or modify any federally funded contract, grant, loan, or cooperative agreement.

3. The Disclosing Party will submit an updated certification at the end of each calendar quarter in which there occurs any event that materially affects the accuracy of the statements and information set forth in paragraphs A.1. and A.2. above.

4. The Disclosing Party certifies that either: (i) it is not an organization described in section 501(c)(4) of the Internal Revenue Code of 1986; or (ii) it is an organization described in section 501(c)(4) of the Internal Revenue Code of 1986 but has not engaged and will not engage in "Lobbying Activities".

5. If the Disclosing Party is the Applicant, the Disclosing Party must obtain certifications equal in form and substance to paragraphs A.1. through A.4. above from all subcontractors before it awards any subcontract and the Disclosing Party must maintain all such subcontractors' certifications for the duration of the Matter and must make such certifications promptly available to the City upon request.

B. CERTIFICATION REGARDING EQUAL EMPLOYMENT OPPORTUNITY

If the Matter is federally funded, federal regulations require the Applicant and all proposed subcontractors to submit the following information with their bids or in writing at the outset of negotiations.

Is the Disclosing Party the Applicant?

Yes

No

If "Yes," answer the three questions below:

1. Have you developed and do you have on file affirmative action programs pursuant to applicable federal regulations? (See 41 CFR Part 60-2.)

Yes

No

2. Have you filed with the Joint Reporting Committee, the Director of the Office of Federal Contract Compliance Programs, or the Equal Employment Opportunity Commission all reports due under the applicable filing requirements?

Yes

No

3. Have you participated in any previous contracts or subcontracts subject to the equal opportunity clause?

Yes

No

If you checked "No" to question 1. or 2. above, please provide an explanation:

SECTION VII -- ACKNOWLEDGMENTS, CONTRACT INCORPORATION, COMPLIANCE, PENALTIES, DISCLOSURE

The Disclosing Party understands and agrees that:

A. The certifications, disclosures, and acknowledgments contained in this EDS will become part of any contract or other agreement between the Applicant and the City in connection with the Matter, whether procurement, City assistance, or other City action, and are material inducements to the City's execution of any contract or taking other action with respect to the Matter. The Disclosing Party understands that it must comply with all statutes, ordinances, and regulations on which this EDS is based.

B. The City's Governmental Ethics and Campaign Financing Ordinances, Chapters 2-156 and 2-164 of the Municipal Code, impose certain duties and obligations on persons or entities seeking City contracts, work, business, or transactions. The full text of these ordinances and a training program is available on line at www.cityofchicago.org/Ethics, and may also be obtained from the City's Board of Ethics, 740 N.

Sedgwick St., Suite 500, Chicago, IL 60610, (312) 744-9660. The Disclosing Party must comply fully with the applicable ordinances.

C. If the City determines that any information provided in this EDS is false, incomplete or inaccurate, any contract or other agreement in connection with which it is submitted may be rescinded or be void or voidable, and the City may pursue any remedies under the contract or agreement (if not rescinded or void), at law, or in equity, including terminating the Disclosing Party's participation in the Matter and/or declining to allow the Disclosing Party to participate in other transactions with the City. Remedies at law for a false statement of material fact may include incarceration and an award to the City of treble damages.

D. It is the City's policy to make this document available to the public on its Internet site and/or upon request. Some or all of the information provided on this EDS and any attachments to this EDS may be made available to the public on the Internet, in response to a Freedom of Information Act request, or otherwise. By completing and signing this EDS, the Disclosing Party waives and releases any possible rights or claims which it may have against the City in connection with the public release of information contained in this EDS and also authorizes the City to verify the accuracy of any information submitted in this EDS.

E. The information provided in this EDS must be kept current. In the event of changes, the Disclosing Party must supplement this EDS up to the time the City takes action on the Matter. If the Matter is a contract being handled by the City's Department of Procurement Services, the Disclosing Party must update this EDS as the contract requires. **NOTE:** With respect to Matters subject to Article I of Chapter 1-23 of the Municipal Code (imposing **PERMANENT INELIGIBILITY** for certain specified offenses), the information provided herein regarding eligibility must be kept current for a longer period, as required by Chapter 1-23 and Section 2-154-020 of the Municipal Code.

The Disclosing Party represents and warrants that:

F.1. The Disclosing Party is not delinquent in the payment of any tax administered by the Illinois Department of Revenue, nor are the Disclosing Party or its Affiliated Entities delinquent in paying any fine, fee, tax or other charge owed to the City. This includes, but is not limited to, all water charges, sewer charges, license fees, parking tickets, property taxes or sales taxes.

F.2. If the Disclosing Party is the Applicant, the Disclosing Party and its Affiliated Entities will not use, nor permit their subcontractors to use, any facility listed by the U.S. E.P.A. on the federal Excluded Parties List System ("EPLS") maintained by the U. S. General Services Administration.

F.3. If the Disclosing Party is the Applicant, the Disclosing Party will obtain from any contractors/subcontractors hired or to be hired in connection with the Matter certifications equal in form and substance to those in F.1. and F.2. above and will not, without the prior written consent of the City, use any such contractor/subcontractor that does not provide such certifications or that the Disclosing Party has reason to believe has not provided or cannot provide truthful certifications.

NOTE: If the Disclosing Party cannot certify as to any of the items in F.1., F.2. or F.3. above, an explanatory statement must be attached to this EDS.

CERTIFICATION

Under penalty of perjury, the person signing below: (1) warrants that he/she is authorized to execute this EDS and Appendix A (if applicable) on behalf of the Disclosing Party, and (2) warrants that all certifications and statements contained in this EDS and Appendix A (if applicable) are true, accurate and complete as of the date furnished to the City.

5200 HARPER APT LLC % LOUIS NAJJAR
(Print or type name of Disclosing Party)

By: *Louis Najjar*
(Sign here)

LOUIS NAJJAR
(Print or type name of person signing)

MEMBER
(Print or type title of person signing)

Signed and sworn to before me on (date) 6/28/2011,
at COOK County, IL (state).

Raeka Aiyash Notary Public.

Commission expires: 6/30/2012.

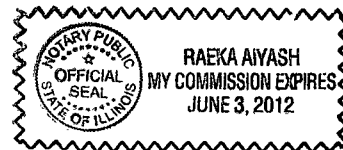

**CITY OF CHICAGO
ECONOMIC DISCLOSURE STATEMENT AND AFFIDAVIT
APPENDIX A**

FAMILIAL RELATIONSHIPS WITH ELECTED CITY OFFICIALS AND DEPARTMENT HEADS

This Appendix is to be completed only by (a) the Applicant, and (b) any legal entity which has a direct ownership interest in the Applicant exceeding 7.5 percent. It is not to be completed by any legal entity which has only an indirect ownership interest in the Applicant.

Under Municipal Code Section 2-154-015, the Disclosing Party must disclose whether such Disclosing Party or any “Applicable Party” or any Spouse or Domestic Partner thereof currently has a “familial relationship” with any elected city official or department head. A “familial relationship” exists if as of the date this EDS is signed, the Disclosing Party or any “Applicable Party” or any Spouse or Domestic Partner thereof is related to the mayor, any alderman, the city clerk, the city treasurer or any city department head as spouse or domestic partner or as any of the following, whether by blood or adoption: parent, child, brother or sister, aunt or uncle, niece or nephew, grandparent, grandchild, father-in-law, mother-in-law, son-in-law, daughter-in-law, stepfather or stepmother, stepson or stepdaughter, stepbrother or stepsister or half-brother or half-sister.

“Applicable Party” means (1) all executive officers of the Disclosing Party listed in Section II.B.1.a., if the Disclosing Party is a corporation; all partners of the Disclosing Party, if the Disclosing Party is a general partnership; all general partners and limited partners of the Disclosing Party, if the Disclosing Party is a limited partnership; all managers, managing members and members of the Disclosing Party, if the Disclosing Party is a limited liability company; (2) all principal officers of the Disclosing Party; and (3) any person having more than a 7.5 percent ownership interest in the Disclosing Party. “Principal officers” means the president, chief operating officer, executive director, chief financial officer, treasurer or secretary of a legal entity or any person exercising similar authority.

Does the Disclosing Party or any “Applicable Party” or any Spouse or Domestic Partner thereof currently have a “familial relationship” with an elected city official or department head?

Yes

No

If yes, please identify below (1) the name and title of such person, (2) the name of the legal entity to which such person is connected; (3) the name and title of the elected city official or department head to whom such person has a familial relationship, and (4) the precise nature of such familial relationship.

5200 Harper Apartments, LLC
P.O. Box 4047
Naperville, IL 60567

James Walker – 5129 S. Harper, CHICAGO, IL 60615

Ruben White – 5137 S. Harper, CHICAGO, IL 60615

Dennis Forester – 5135 S. Harper, CHICAGO, IL 60615

Moe Finkle – 5141 S. Harper, CHICAGO, IL 60615

Jeff Sons – 5134 S. Harper, CHICAGO, IL 60615

Ingred Soto – 5120 S. Harper, CHICAGO, IL 60615

Marian McKinzie – 1440 E. 52nd St., CHICAGO, IL 60615

Danial Heralds – 1451 E. 52nd St., CHICAGO, IL 60615

Clifford Sands – 1508 E. 52nd St. CHICAGO, IL 60615

University of Chicago

Civic Engagements

5801 S. Ellis

CHICAGO, IL 60637

McDonalds - 5220 S Lake Park Ave, CHICAGO, IL 60615

MAC Properties – 1364 E. 53rd St. CHICAGO, IL 60615

LEGEND

●	IRON PIPE	ASPH	ASPHALT
○	MANHOLE	BC	BUILDING CORNER
⊙	TREE	BLDG	BUILDING
⊙	FIRE HYDRANT	BOC	BACK OF CURB
⊙	LIGHT POLE	CB	CATCH BASIN
⊙	WATER VALVE	CONC.	CONCRETE
⊙	CATCH BASIN	CP	CONTROL POINT
⊙	SANITARY MANHOLE	℄	CENTER LINE
⊙	INLET	DRC	DRIVE CONCRETE
⊙	STORM MANHOLE	EOP	EDGE OF PAVEMENT
⊙	UTILITY POLE	FSC	FENCE CORNER
+	CROSS NOTCH	GA	GARAGE
		GR	GRASS
		IP	IRON PIPE
		LP	LIGHT POLE
		MH	MANHOLE
		NTS	NOT TO SCALE
		POI	POINT OF INTERSECTION
		REC	PLATTED DISTANCE
		ROW	RIGHT OF WAY
		SF	SQUARE OF FEET
		TEL	TELEPHONE
		T/F	TOP OF FOUNDATION
		TOW	TOP OF WALL
		WV	WATER VALVE
—	PROPERTY LINE		
—	BUILDING LINE		
—	SIDEWALK LINE		
- - -	CENTERLINE		
x x x x x	CHAIN LINK FENCE		
— □ —	WOOD FENCE		
— ○ —	CARBON FENCE		
— (—	STORM SEWER		
— (—	SANITARY SEWER		

M
M
D

MORADI MULTI DIMENSIONS CONSULTING ENGINEERS

2343 W. IRVING PARK RD
CHICAGO, IL. 60618

PHONE: (773) 478 - 6666
FAX: (773) 478 - 6667

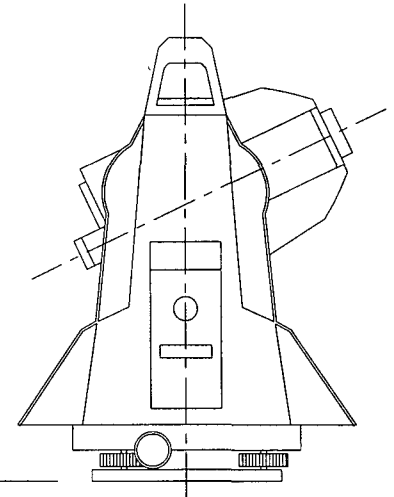

JOB #: 127-11
ADDRESS: 5200 S. HARPER AVE., CHICAGO, IL.

PROFESSIONAL DESIGN FIRM LS/PE/SE REGISTRATION NO. 184-002111

PLAT OF SURVEY

LOT 1 LOT 2 (EXCEPT THE SOUTH 25.00 FEET THEREOF) IN BLOCK 21 IN HYDE PARK BEING A SUBDIVISION OF THE EAST 1/2 OF SOUTHEAST 1/4 AND EAST 1/2 OF NORTHEAST 1/4 OF SECTION 11 AND NORTH PART OF SOUTHWEST FRACTIONAL 1/4 OF SECTION 12 AND NORTHEAST 1/4 OF THE NORTHEAST 1/4 OF SECTION 14, TOWNSHIP 38 NORTH, RANGE 14, EAST OF THE THIRD PRINCIPAL MERIDIAN, IN COOK COUNTY, ILLINOIS.

LAND TOTAL AREA: 11250 SQ. FT.

COMMONLY KNOWN AS: 5200 SOUTH HARPER AVENUE, CHICAGO, ILLINOIS.



SCALE: 1 INCH = 16 FEET

E. 52ND

ST.

S. HARPER
AVE.

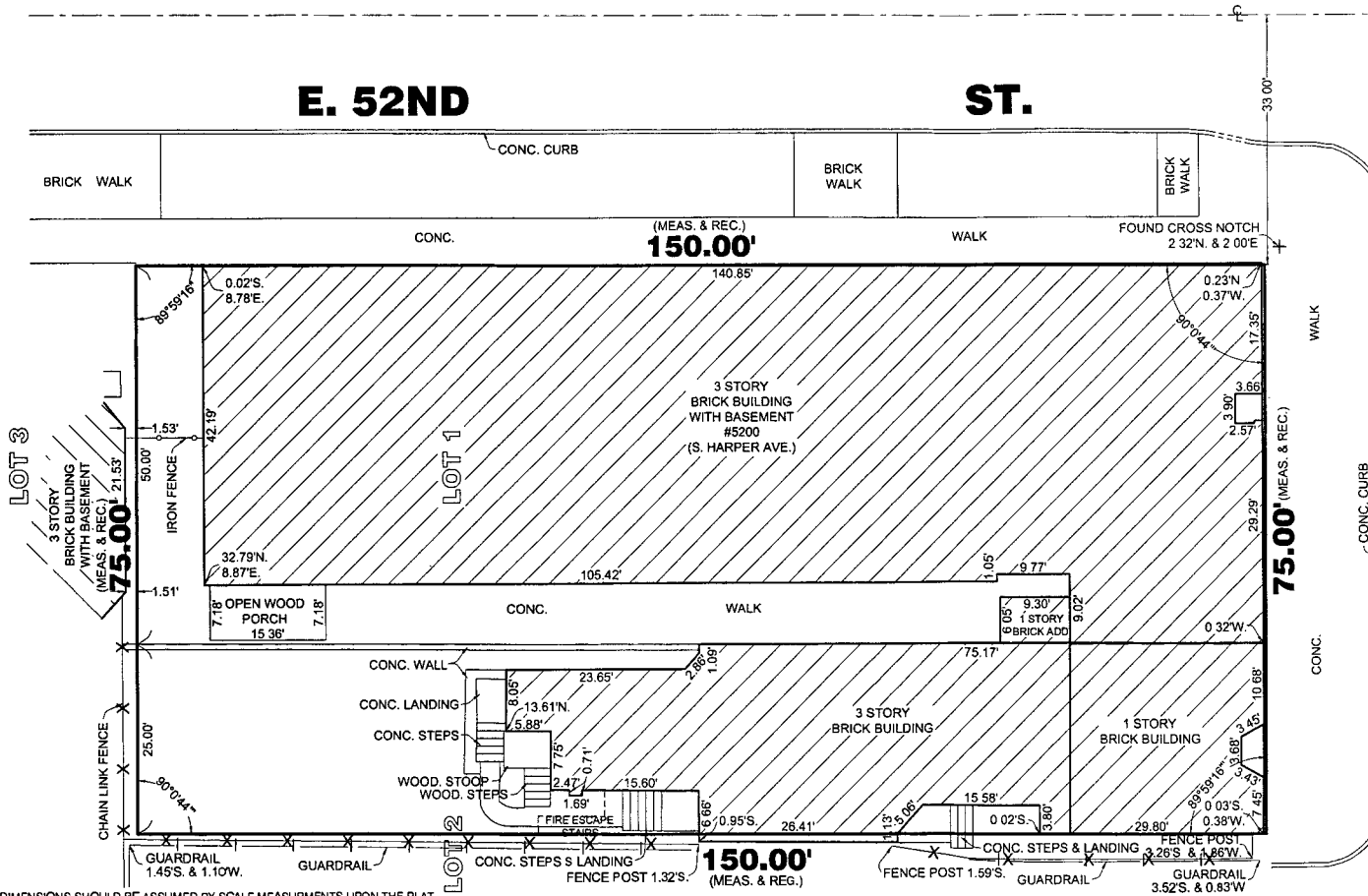

THIS PROFESSIONAL SERVICE CONFORMS TO THE CURRENT ILLINOIS MINIMUM STANDARDS FOR A BOUNDARY SURVEY. I, THE UNDERSIGNED, AN ILLINOIS REGISTERED LAND SURVEYOR, HEREBY CERTIFY TO THE ABOVE NAMED PARTY THAT ON THE DATE SHOWN AN INSPECTION OF THE REAL ESTATE DESCRIBED HEREIN WAS MADE AND THAT TO THE BEST OF MY KNOWLEDGE AND BELIEF THIS PLAT REPRESENTS THE FACTS FOUND AT SAID TIME. PROPERTY CORNERS ARE SET OR NOT BY CLIENT AGREEMENT. SUBJECT PROPERTY HAS NOT BEEN STAKED AND THEREFORE FOR ANY CONSTRUCTION OR ESTABLISHING BOUNDARY OR FENCE LINE SHALL BE STAKED BY A SURVEYOR BEFORE PERFORMING THE TASK.

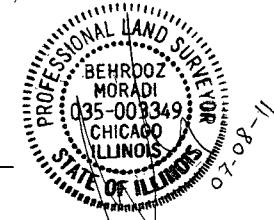

NO DIMENSIONS SHOULD BE ASSUMED BY SCALE MEASUREMENTS UPON THE PLAT.
BOUNDARY DIMENSIONS ARE BASED ON THE PUBLIC RECORDS AND/OR DESCRIPTION PROVIDED.
FOR LEGENDS SEE OTHER SIDE OF THIS PAGE



MORADI MULTI DIMENSIONS
CONSULTING ENGINEERS

2343 W IRVING PARK RD, CHICAGO, IL 60618
TEL: (773)478-6666, FAX: (773)478-6667

JOB # . 127-11	DRAWN: HA	DATE: 07/08/2011	CLIENT A W MANAGEMENT
SHEET . 1	CHECKED: BM	SCALE: 1"=16'-0"	DATE OF FIELD WORK 07/07/2011

THE LEGAL DESCRIPTION NOTED ON THIS PLAT WAS PROVIDED BY THE CLIENT AND MUST BE COMPARED WITH DEED AND/OR TITLE POLICY. BUILDING LINES AND EASEMENTS ARE SHOWN ONLY WHERE THERE ARE SO RECORDED IN THE MAPS. OTHERWISE FOR BUILDING RESTRICTIONS AND/OR EASEMENTS REFER TO YOUR DEED, CONTRACT, TITLE POLICY, AND/OR ZONING REGULATIONS. THIS PLAT IS VALID ONLY IF IT CONTAINS THE ORIGINAL SIGNATURE AND SEAL OF THE SURVEYOR. IF YOU HAVE ANY QUESTIONS, PLEASE DO NOT HESITATE TO CONTACT US

Illinois Land Surveyor Number 035-003349
BEHROOZ MORADI, PhD, P.E., S.E., P.L.S.
IL PROF LAND SURVEYOR - LICENSE EXP DATE NOV 30, 2012.