



Office of the Chicago City  
Clerk



O2011-7803

Office of the City Clerk

City Council Document Tracking Sheet

<b>Meeting Date:</b>	9/8/2011
<b>Sponsor(s):</b>	Reboyras, Ariel (30)
<b>Type:</b>	Ordinance
<b>Title:</b>	Grant(s) of Privilege in Public Way for City Smiles
<b>Committee(s) Assignment:</b>	Committee on Transportation and Public Way

ORDINANCE  
CITY SMILES  
Acct. No. 295161 - 1  
Permit No. 1096438

*Be It Ordained by the City Council of the City of Chicago:*

SECTION 1. Permission and authority are hereby given and granted to CITY SMILES, upon the terms and subject to the conditions of this ordinance to maintain and use, as now constructed, six (6) Light Fixture(s) projecting over the public right-of-way adjacent to its premises known as 3800 N. Pulaski Rd..

Said Light Fixture(s) at N. Pulaski measure(s):

Six (6) at three (3) feet in length, three point five (3.5) feet in width and ten (10) feet above grade level.

The location of said privilege shall be as shown on prints kept on file with the Department of Business Affairs and Consumer Protection and the Office of the City Clerk.

Said privilege shall be constructed in accordance with plans and specifications approved by the Department of Transportation (Division of Project Development).

This grant of privilege in the public way shall be subject to the provisions of Section 10-28-015 and all other required provisions of the Municipal Code of Chicago.

The grantee shall pay to the City of Chicago as compensation for the privilege #1096438 herein granted the sum of seventy-five (\$75.00) per annum in advance.

A 25% penalty will be added for payments received after due date.

The permit holder agrees to hold the City of Chicago harmless for any damage, relocation or replacement costs associated with damage, relocation or removal of private property caused by the City performing work in the public way.

Authority herein given and granted for a period of five (5) years from and after Date of Passage.

Alderman \_\_\_\_\_



Ariel Reboyras 30th Ward

# Angle Shades







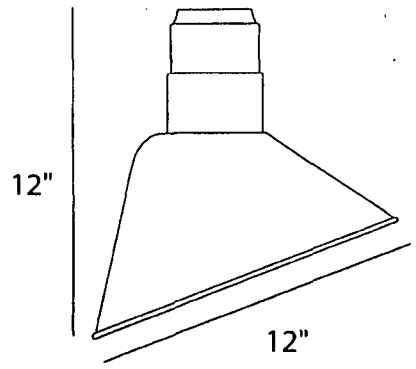
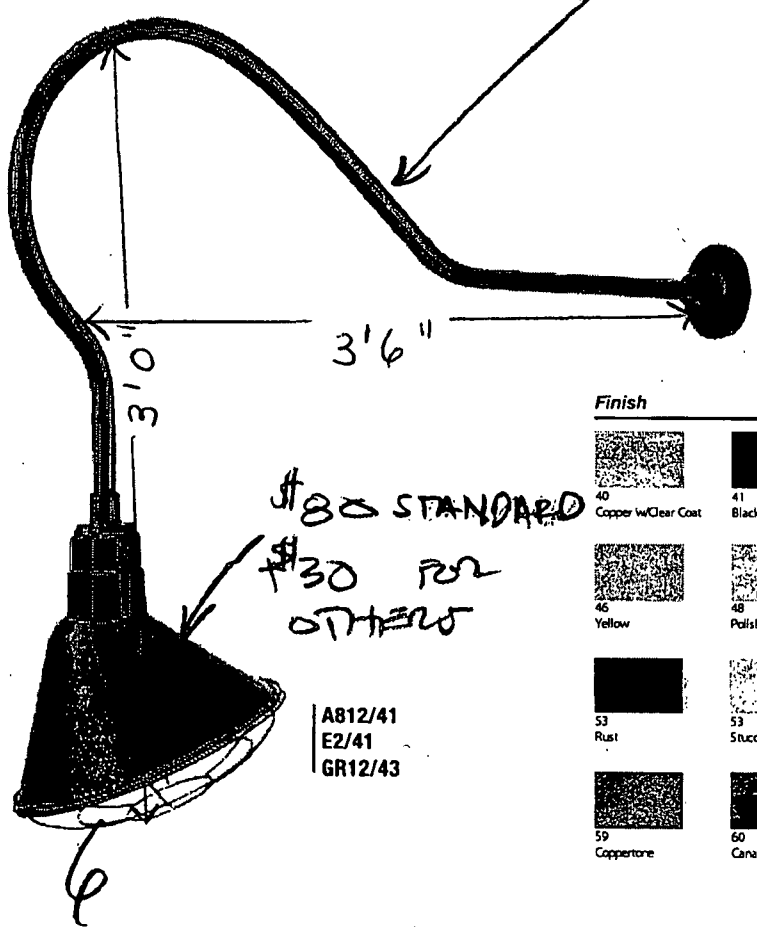















\$85

EACH ARM

+\$15 FOR OTHER FINISHES



## Finish

 40 Copper w/Clear Coat	 41 Black	 42 Dk Green	 43 Red	 44 White	 45 Med. Blue
 46 Yellow	 48 Polish Aluminium	 49 Galvanized	 50 Navy Blue	 51 Arch. Bronze	 52 Patina
 53 Rust	 53 Stucco	 55 Sage	 56 Satin Aluminium Satin Copper/Clear Coat	 57 Polish Aluminium	 58 Satin Aluminium Clear Coat
 59 Coppertone	 60 Canal Green	 61 Anodized Charcoal	 62 Anodized Bronze	 63 Iron Rust	

\$85 STANDARD

+\$30 FOR OTHERS

AB12/41  
E2/41  
GR12/43



Department of Business Affairs and Consumer Protection

Business Assistance Center - Public Way Use Unit

City Hall - 121 N. LaSalle Street, Room 800 • Chicago, IL 60602

(312)-74-GOBIZ (312-744-6249) • (312) 744-1944 (TTY)

<http://www.cityofchicago.org/bacp>

09/08/2011

Alderman **Ariel Reboyras**

Ward # 30

City of Chicago

City Hall, Room 203

121 North LaSalle Street

Chicago, Illinois 60602

Re: An ordinance to use and maintain a portion of the public right-of-way for **six (6) light fixture(s)** for **CITY SMILES**, adjacent to the premises known as **3800 N. Pulaski Rd.**

Dear Alderman **Ariel Reboyras**:

The applicant referenced above has requested the use of the public right-of-way for a **light fixture(s)**. An ordinance has been prepared by the Department of Business Affairs and Consumer Protection – Business Assistance Center - Public Way Use Unit for presentation to the City Council. Because this request was made for properties located in your ward, as approved by you as per the attached, I respectfully request that you introduce the attached ordinance at the next City Council meeting.

If you have any questions regarding this ordinance, please contact John Mariane, Manager, Business Assistance Center - Public Way Use Unit, at (312) 744-2063.

**Department of Business Affairs and Consumer Protection**