



Office of the City Clerk



O2013-35

Office of the City Clerk

City Council Document Tracking Sheet

Meeting Date:	1/17/2013
Sponsor(s):	Mendoza, Susana A. (Clerk)
Type:	Ordinance
Title:	Zoning Reclassification App No. 17655 at 2847 W Jackson Blvd
Committee(s) Assignment:	Committee on Zoning, Landmarks and Building Standards

ORDINANCE

BE IT ORDAINED BY THE CITY COUNCIL OF THE CITY OF CHICAGO:

SECTION 1: That the Chicago Zoning Ordinance be amended by changing all the RT-4 Residential Two-Flat, Townhouse and Multi-Unit District symbols and designations as shown on Map No. 2-I in the area bounded by

West Jackson Blvd.; a line 143.56 feet East of and parallel to North Francisco Avenue; the alley next South of and parallel to West Jackson Blvd.; and a line 118.56 feet East of and parallel to North Francisco Avenue;

to those of a B3-3 Community Shopping District and a corresponding use district is hereby established in the area above described.

SECTION 2: This Ordinance shall be in force and effect from and after its passage and due publication.

#17655
INTRO DATE:
1-17-2013

CITY OF CHICAGO

APPLICATION FOR AN AMENDMENT TO
THE CHICAGO ZONING ORDINANCE

1. ADDRESS of the property Applicant is seeking to rezone:

2847 W. Jackson Blvd.

2. Ward Number that property is located in: 2nd Ward (Ald. Robert Fioretti)

3. APPLICANT Marillac Social Center, a not-for-profit corporation

ADDRESS 212 S. Francisco Ave. CITY Chicago

STATE IL ZIP CODE 60612 PHONE 773-722-7440

EMAIL bwinters@svdpc.org CONTACT PERSON Bart winters

4. Is the applicant the owner of the property? YES _____ NO

If the applicant is not the owner of the property, please provide the following information regarding the owner and attach written authorization from the owner allowing the application to proceed.

OWNER Daughters of Charity Ministries, Inc.

ADDRESS 4330 Olive Street CITY St. Louis

STATE MO ZIP CODE 63108 PHONE 314-533-4770

EMAIL Jane.Graves@doc.org CONTACT PERSON Sister Jane Graves

5. If the Applicant/Owner of the property has obtained a lawyer as their representative for the rezoning, please provide the following information:

ATTORNEY John J. George / Chris A. Leach

ADDRESS Schuyler, Roche & Crisham 130 E. Randolph St. Ste. 3800

CITY Chicago STATE IL ZIP CODE 60601

PHONE 312-565-8439 FAX 312-565-8300 EMAIL jgeorge@scrattori

1942
1943
1944

6. If the applicant is a legal entity (Corporation, LLC, Partnership, etc.) please provide the names of all owners as disclosed on the Economic Disclosure Statements.

Applicant is a not-for-profit corporation and
therefore has no owners.

7. On what date did the owner acquire legal title to the subject property? June 20, 2012

8. Has the present owner previously rezoned this property? If yes, when?
No

9. Present Zoning District RT-4 Proposed Zoning District B3-3

10. Lot size in square feet (or dimensions) 3,125 sq. ft. (25' x 125')

11. Current Use of the property Vacant

12. Reason for rezoning the property is to add the property to a larger
development site with the zoning designation of B3-3.

13. Describe the proposed use of the property after the rezoning. Indicate the number of dwelling units; number of parking spaces; approximate square footage of any commercial space; and height of the proposed building. (BE SPECIFIC)
To rehabilitate an existing 23,809 sq. ft. building and to add
on a 3,514 sq. ft. addition for a new community center containi:
a total of 27,323 sq. ft.

14. On May 14th, 2007, the Chicago City Council passed the Affordable Requirements Ordinance (ARO) that requires on-site affordable housing units or a financial contribution if residential housing projects receive a zoning change under certain circumstances. Based on the lot size of the project in question and the proposed zoning classification, is this project subject to the Affordable Requirements Ordinance? (See Fact Sheet for more information)

YES _____ NO x _____

COUNTY OF COOK
STATE OF ILLINOIS

Bart Winters

_____, being first duly sworn on oath, states that all of the above statements and the statements contained in the documents submitted herewith are true and correct.

Bart Winters

Signature of Applicant

Subscribed and Sworn to before me this
21st day of December, 2012.

Nancy Q. Gill

Notary Public

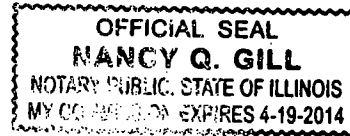

For Office Use Only

Date of Introduction: _____

File Number: _____

Ward: _____

ZONING NARRATIVE

Marillac Social Center
2847 W. Jackson Blvd.
Chicago Illinois

This is a proposed zoning amendment to amend the RT-4 zoning district to the B3-3 zoning district in order to add the subject property to a larger development site with the zoning designation of B3-3:

1. The subject property is located at 2847 West Jackson Blvd. and is bounded by West Jackson Blvd.; a line 143.56 feet East of and parallel to North Francisco Avenue; the alley next South of and parallel to West Jackson Blvd.; and a line 118.56 feet East of and parallel to North Francisco Avenue and contains approximately 3,126 square feet of property.
2. The subject property is currently vacant.
3. The site is bounded by zoning district RM-5 to the North, by RT-4 to the East, RT-4 to the South and B3-3 to the West.
4. The Applicant proposes to add the subject property to a larger development site in order to rehabilitate their existing 23,809 sq. ft. building located at 2849 W. Jackson Blvd., and to add on a 3,514 sq. ft. addition for a new community center containing a total of 27,323 sq. ft. The new community center will provide social service programming space for computer labs, classroom space, offices, library facilities as well as recreational areas consisting of a gymnasium, fitness area, stage, and recreation room and will maintain the existing food pantry.
5. Zoning Analysis:
 - a. FAR: permitted 3.0 FAR as proposed: 0.66
 - b. Number of dwelling units: zero
 - c. Setbacks: North 2', East 3'-1", South 0' and West 11"
 - d. Height: 26' -1'
 - e. Parking: If the proposed zoning change is approved for the subject property, the applicant will seeking special use permits to establish and to operate the new community center upon the larger development site located at 2847-59 W. Jackson Blvd. and 301-311 S. Francisco Avenue and a special use permit to allow required parking for the proposed community center to be provided off-site across the street from the proposed community center at a surface parking lot located at the southwest corner of Jackson Blvd. and Francisco containing 51 parking spaces. The required parking for a community center is determined by the Department of Housing and Economic Development.

CONFIRMATION OF AUTHORITY

TO WHOM IT MAY CONCERN:

The undersigned, Daughters of Charity Ministries, Inc., the property owner of the property commonly known as 2847 W. Jackson Blvd, Chicago, Illinois, hereby confirms that the Zoning Applicant, Marillac Social Center is authorized by the undersigned to file an Application for Amendment to the Chicago Zoning Ordinance concerning the above-described property.

Dated this 16th day of November, 2012.

PROPERTY OWNER:

Daughters of Charity Ministries, Inc.

By: Sister Jane Graves

Printed Name: Sister Jane Graves

Title: Treasurer

Subscribed and sworn to
before me this 16th day
of November, 2012.

Juanita Whitfield
Notary Public



JUANITA WHITFIELD
My Commission Expires
June 8, 2013
St. Louis County
Commission #09714486

**CITY OF CHICAGO
ECONOMIC DISCLOSURE STATEMENT
AND AFFIDAVIT**

SECTION I -- GENERAL INFORMATION

A. Legal name of the Disclosing Party submitting this EDS. Include d/b/a/ if applicable:

Marillac Social Center

Check ONE of the following three boxes:

Indicate whether the Disclosing Party submitting this EDS is:

1. the Applicant

OR

2. a legal entity holding a direct or indirect interest in the Applicant. State the legal name of the Applicant in which the Disclosing Party holds an interest: _____

OR

3. a legal entity with a right of control (see Section II.B.1.) State the legal name of the entity in which the Disclosing Party holds a right of control: _____

B. Business address of the Disclosing Party:

212 South Francisco Ave

Chicago, IL 60612

C. Telephone: 773-722-7440 Fax: 773-722-1469 Email: bwinters@svdpc.org

D. Name of contact person: Bart Winters

E. Federal Employer Identification No. (if you have one): _____

F. Brief description of contract, transaction or other undertaking (referred to below as the "Matter") to which this EDS pertains. (Include project number and location of property, if applicable):

Zoning Amendment Application for 2847 West Jackson Blvd.

G. Which City agency or department is requesting this EDS? Dept. of Housing and Economic Development

If the Matter is a contract being handled by the City's Department of Procurement Services, please complete the following:

Specification # _____ and Contract # _____

SECTION II -- DISCLOSURE OF OWNERSHIP INTERESTS

A. NATURE OF THE DISCLOSING PARTY

1. Indicate the nature of the Disclosing Party:

- | | |
|---|---|
| <input type="checkbox"/> Person | <input type="checkbox"/> Limited liability company |
| <input type="checkbox"/> Publicly registered business corporation | <input type="checkbox"/> Limited liability partnership |
| <input type="checkbox"/> Privately held business corporation | <input type="checkbox"/> Joint venture |
| <input type="checkbox"/> Sole proprietorship | <input checked="" type="checkbox"/> Not-for-profit corporation |
| <input type="checkbox"/> General partnership | (Is the not-for-profit corporation also a 501(c)(3))? |
| <input type="checkbox"/> Limited partnership | <input checked="" type="checkbox"/> Yes <input type="checkbox"/> No |
| <input type="checkbox"/> Trust | <input type="checkbox"/> Other (please specify) |

2. For legal entities, the state (or foreign country) of incorporation or organization, if applicable:

Illinois

3. For legal entities not organized in the State of Illinois: Has the organization registered to do business in the State of Illinois as a foreign entity?

- Yes No N/A

B. IF THE DISCLOSING PARTY IS A LEGAL ENTITY:

1. List below the full names and titles of all executive officers and all directors of the entity.

NOTE: For not-for-profit corporations, also list below all members, if any, which are legal entities. If there are no such members, write "no members." For trusts, estates or other similar entities, list below the legal titleholder(s).

If the entity is a general partnership, limited partnership, limited liability company, limited liability partnership or joint venture, list below the name and title of each general partner, managing member, manager or any other person or entity that controls the day-to-day management of the Disclosing Party.

NOTE: Each legal entity listed below must submit an EDS on its own behalf.

Name	Title
John Rowan	Chairperson
Fred Hogan	Vice-Chair
Dorothy Jiganti	Secretary
Sister Marsha Tierney, D.C.	Treasurer
Bart Winters	Chief Executive Officer

2. Please provide the following information concerning each person or entity having a direct or indirect beneficial interest (including ownership) in excess of 7.5% of the Disclosing Party. Examples of such an interest include shares in a corporation, partnership interest in a partnership or joint venture,

interest of a member or manager in a limited liability company, or interest of a beneficiary of a trust, estate or other similar entity. If none, state "None." **NOTE:** Pursuant to Section 2-154-030 of the Municipal Code of Chicago ("Municipal Code"), the City may require any such additional information from any applicant which is reasonably intended to achieve full disclosure.

Name	Business Address	Percentage Interest in the Disclosing Party
NONE		

SECTION III -- BUSINESS RELATIONSHIPS WITH CITY ELECTED OFFICIALS

Has the Disclosing Party had a "business relationship," as defined in Chapter 2-156 of the Municipal Code, with any City elected official in the 12 months before the date this EDS is signed?

- Yes No

If yes, please identify below the name(s) of such City elected official(s) and describe such relationship(s):

SECTION IV -- DISCLOSURE OF SUBCONTRACTORS AND OTHER RETAINED PARTIES

The Disclosing Party must disclose the name and business address of each subcontractor, attorney, lobbyist, accountant, consultant and any other person or entity whom the Disclosing Party has retained or expects to retain in connection with the Matter, as well as the nature of the relationship, and the total amount of the fees paid or estimated to be paid. The Disclosing Party is not required to disclose employees who are paid solely through the Disclosing Party's regular payroll.

"Lobbyist" means any person or entity who undertakes to influence any legislative or administrative action on behalf of any person or entity other than: (1) a not-for-profit entity, on an unpaid basis, or (2) himself. "Lobbyist" also means any person or entity any part of whose duties as an employee of another includes undertaking to influence any legislative or administrative action.

If the Disclosing Party is uncertain whether a disclosure is required under this Section, the Disclosing Party must either ask the City whether disclosure is required or make the disclosure.

Name (indicate whether retained or anticipated to be retained)	Business Address	Relationship to Disclosing Party (subcontractor, attorney, lobbyist, etc.)	Fees (indicate whether paid or estimated.) NOTE: "hourly rate" or "t.b.d." is not an acceptable response.
John J. George	20 S. Clark St., Suite 400 Chicago, IL 60603	Attorney	Est. \$7,500.00
Worn Jerabek Architects, P.C.	212 W Superior St., Suite 600 Chicago, IL 60654	Architect	Est. \$207,000.00

(Add sheets if necessary)

Check here if the Disclosing Party has not retained, nor expects to retain, any such persons or entities.

SECTION V -- CERTIFICATIONS

A. COURT-ORDERED CHILD SUPPORT COMPLIANCE

Under Municipal Code Section 2-92-415, substantial owners of business entities that contract with the City must remain in compliance with their child support obligations throughout the contract's term.

Has any person who directly or indirectly owns 10% or more of the Disclosing Party been declared in arrearage on any child support obligations by any Illinois court of competent jurisdiction?

Yes No No person directly or indirectly owns 10% or more of the Disclosing Party.

If "Yes," has the person entered into a court-approved agreement for payment of all support owed and is the person in compliance with that agreement?

Yes No

B. FURTHER CERTIFICATIONS

1. Pursuant to Municipal Code Chapter 1-23, Article I ("Article I")(which the Applicant should consult for defined terms (e.g., "doing business") and legal requirements), if the Disclosing Party submitting this EDS is the Applicant and is doing business with the City, then the Disclosing Party certifies as follows: (i) neither the Applicant nor any controlling person is currently indicted or charged with, or has admitted guilt of, or has ever been convicted of, or placed under supervision for, any criminal offense involving actual, attempted, or conspiracy to commit bribery, theft, fraud, forgery, perjury, dishonesty or deceit against an officer or employee of the City or any sister agency; and (ii) the Applicant understands and acknowledges that compliance with Article I is a continuing requirement for doing business with the City. NOTE: If Article I applies to the Applicant, the permanent compliance timeframe in Article I supersedes some five-year compliance timeframes in certifications 2 and 3 below.

2. The Disclosing Party and, if the Disclosing Party is a legal entity, all of those persons or entities identified in Section II.B.1. of this EDS:

- a. are not presently debarred, suspended, proposed for debarment, declared ineligible or voluntarily excluded from any transactions by any federal, state or local unit of government;
- b. have not, within a five-year period preceding the date of this EDS, been convicted of a criminal offense, adjudged guilty, or had a civil judgment rendered against them in connection with: obtaining, attempting to obtain, or performing a public (federal, state or local) transaction or contract under a public transaction; a violation of federal or state antitrust statutes; fraud; embezzlement; theft; forgery; bribery; falsification or destruction of records; making false statements; or receiving stolen property;
- c. are not presently indicted for, or criminally or civilly charged by, a governmental entity (federal, state or local) with committing any of the offenses set forth in clause B.2.b. of this Section V;
- d. have not, within a five-year period preceding the date of this EDS, had one or more public transactions (federal, state or local) terminated for cause or default; and
- e. have not, within a five-year period preceding the date of this EDS, been convicted, adjudged guilty, or found liable in a civil proceeding, or in any criminal or civil action, including actions concerning environmental violations, instituted by the City or by the federal government, any state, or any other unit of local government.

3. The certifications in subparts 3, 4 and 5 concern:

- the Disclosing Party;
- any "Contractor" (meaning any contractor or subcontractor used by the Disclosing Party in connection with the Matter, including but not limited to all persons or legal entities disclosed under Section IV, "Disclosure of Subcontractors and Other Retained Parties");
- any "Affiliated Entity" (meaning a person or entity that, directly or indirectly: controls the Disclosing Party, is controlled by the Disclosing Party, or is, with the Disclosing Party, under common control of another person or entity. Indicia of control include, without limitation: interlocking management or ownership; identity of interests among family members, shared facilities and equipment; common use of employees; or organization of a business entity following the ineligibility of a business entity to do business with federal or state or local government, including the City, using substantially the same management, ownership, or principals as the ineligible entity); with respect to Contractors, the term Affiliated Entity means a person or entity that directly or indirectly controls the Contractor, is controlled by it, or, with the Contractor, is under common control of another person or entity;
- any responsible official of the Disclosing Party, any Contractor or any Affiliated Entity or any other official, agent or employee of the Disclosing Party, any Contractor or any Affiliated Entity, acting pursuant to the direction or authorization of a responsible official of the Disclosing Party, any Contractor or any Affiliated Entity (collectively "Agents").

Neither the Disclosing Party, nor any Contractor, nor any Affiliated Entity of either the Disclosing Party or any Contractor nor any Agents have, during the five years before the date this EDS is signed, or, with respect to a Contractor, an Affiliated Entity, or an Affiliated Entity of a Contractor during the five years before the date of such Contractor's or Affiliated Entity's contract or engagement in connection with the Matter:

- a. bribed or attempted to bribe, or been convicted or adjudged guilty of bribery or attempting to bribe, a public officer or employee of the City, the State of Illinois, or any agency of the federal government or of any state or local government in the United States of America, in that officer's or employee's official capacity;
- b. agreed or colluded with other bidders or prospective bidders, or been a party to any such agreement, or been convicted or adjudged guilty of agreement or collusion among bidders or prospective bidders, in restraint of freedom of competition by agreement to bid a fixed price or otherwise; or
- c. made an admission of such conduct described in a. or b. above that is a matter of record, but have not been prosecuted for such conduct; or
- d. violated the provisions of Municipal Code Section 2-92-610 (Living Wage Ordinance).

4. Neither the Disclosing Party, Affiliated Entity or Contractor, or any of their employees, officials, agents or partners, is barred from contracting with any unit of state or local government as a result of engaging in or being convicted of (1) bid-rigging in violation of 720 ILCS 5/33E-3; (2) bid-rotating in violation of 720 ILCS 5/33E-4; or (3) any similar offense of any state or of the United States of America that contains the same elements as the offense of bid-rigging or bid-rotating.

5. Neither the Disclosing Party nor any Affiliated Entity is listed on any of the following lists maintained by the Office of Foreign Assets Control of the U.S. Department of the Treasury or the Bureau of Industry and Security of the U.S. Department of Commerce or their successors: the Specially Designated Nationals List, the Denied Persons List, the Unverified List, the Entity List and the Debarred List.

6. The Disclosing Party understands and shall comply with the applicable requirements of Chapters 2-55 (Legislative Inspector General), 2-56 (Inspector General) and 2-156 (Governmental Ethics) of the Municipal Code.

7. If the Disclosing Party is unable to certify to any of the above statements in this Part B (Further Certifications), the Disclosing Party must explain below:

None

If the letters "NA," the word "None," or no response appears on the lines above, it will be conclusively presumed that the Disclosing Party certified to the above statements.

8. To the best of the Disclosing Party's knowledge after reasonable inquiry, the following is a complete list of all current employees of the Disclosing Party who were, at any time during the 12-month period preceding the execution date of this EDS, an employee, or elected or appointed official, of the City of Chicago (if none, indicate with "N/A" or "none").

None

9. To the best of the Disclosing Party's knowledge after reasonable inquiry, the following is a complete list of all gifts that the Disclosing Party has given or caused to be given, at any time during the 12-month period preceding the execution date of this EDS, to an employee, or elected or appointed official, of the City of Chicago. For purposes of this statement, a "gift" does not include: (i) anything made generally available to City employees or to the general public, or (ii) food or drink provided in the course of official City business and having a retail value of less than \$20 per recipient (if none, indicate with "N/A" or "none"). As to any gift listed below, please also list the name of the City recipient.

None

C. CERTIFICATION OF STATUS AS FINANCIAL INSTITUTION

1. The Disclosing Party certifies that the Disclosing Party (check one)

is is not

a "financial institution" as defined in Section 2-32-455(b) of the Municipal Code.

2. If the Disclosing Party IS a financial institution, then the Disclosing Party pledges:

"We are not and will not become a predatory lender as defined in Chapter 2-32 of the Municipal Code. We further pledge that none of our affiliates is, and none of them will become, a predatory lender as defined in Chapter 2-32 of the Municipal Code. We understand that becoming a predatory lender or becoming an affiliate of a predatory lender may result in the loss of the privilege of doing business with the City."

If the Disclosing Party is unable to make this pledge because it or any of its affiliates (as defined in Section 2-32-455(b) of the Municipal Code) is a predatory lender within the meaning of Chapter 2-32 of the Municipal Code, explain here (attach additional pages if necessary):

NA

If the letters "NA," the word "None," or no response appears on the lines above, it will be conclusively presumed that the Disclosing Party certified to the above statements.

D. CERTIFICATION REGARDING INTEREST IN CITY BUSINESS

Any words or terms that are defined in Chapter 2-156 of the Municipal Code have the same meanings when used in this Part D.

1. In accordance with Section 2-156-110 of the Municipal Code: Does any official or employee of the City have a financial interest in his or her own name or in the name of any other person or entity in the Matter?

Yes No

NOTE: If you checked "Yes" to Item D.1., proceed to Items D.2. and D.3. If you checked "No" to Item D.1., proceed to Part E.

2. Unless sold pursuant to a process of competitive bidding, or otherwise permitted, no City elected official or employee shall have a financial interest in his or her own name or in the name of any other person or entity in the purchase of any property that (i) belongs to the City, or (ii) is sold for taxes or assessments, or (iii) is sold by virtue of legal process at the suit of the City (collectively, "City Property Sale"). Compensation for property taken pursuant to the City's eminent domain power does not constitute a financial interest within the meaning of this Part D.

Does the Matter involve a City Property Sale?

Yes No

3. If you checked "Yes" to Item D.1., provide the names and business addresses of the City officials or employees having such interest and identify the nature of such interest:

Name	Business Address	Nature of Interest

4. The Disclosing Party further certifies that no prohibited financial interest in the Matter will be acquired by any City official or employee.

E. CERTIFICATION REGARDING SLAVERY ERA BUSINESS

Please check either 1. or 2. below. If the Disclosing Party checks 2., the Disclosing Party must disclose below or in an attachment to this EDS all information required by paragraph 2. Failure to

comply with these disclosure requirements may make any contract entered into with the City in connection with the Matter voidable by the City.

^x 1. The Disclosing Party verifies that the Disclosing Party has searched any and all records of the Disclosing Party and any and all predecessor entities regarding records of investments or profits from slavery or slaveholder insurance policies during the slavery era (including insurance policies issued to slaveholders that provided coverage for damage to or injury or death of their slaves), and the Disclosing Party has found no such records.

2. The Disclosing Party verifies that, as a result of conducting the search in step 1 above, the Disclosing Party has found records of investments or profits from slavery or slaveholder insurance policies. The Disclosing Party verifies that the following constitutes full disclosure of all such records, including the names of any and all slaves or slaveholders described in those records:

SECTION VI -- CERTIFICATIONS FOR FEDERALLY FUNDED MATTERS

NOTE: If the Matter is federally funded, complete this Section VI. If the Matter is not federally funded, proceed to Section VII. For purposes of this Section VI, tax credits allocated by the City and proceeds of debt obligations of the City are not federal funding.

A. CERTIFICATION REGARDING LOBBYING

1. List below the names of all persons or entities registered under the federal Lobbying Disclosure Act of 1995 who have made lobbying contacts on behalf of the Disclosing Party with respect to the Matter: (Add sheets if necessary):

(If no explanation appears or begins on the lines above, or if the letters "NA" or if the word "None" appear, it will be conclusively presumed that the Disclosing Party means that NO persons or entities registered under the Lobbying Disclosure Act of 1995 have made lobbying contacts on behalf of the Disclosing Party with respect to the Matter.)

2. The Disclosing Party has not spent and will not expend any federally appropriated funds to pay any person or entity listed in Paragraph A.1. above for his or her lobbying activities or to pay any person or entity to influence or attempt to influence an officer or employee of any agency, as defined by applicable federal law, a member of Congress, an officer or employee of Congress, or an employee of a member of Congress, in connection with the award of any federally funded contract, making any federally funded grant or loan, entering into any cooperative agreement, or to extend, continue, renew, amend, or modify any federally funded contract, grant, loan, or cooperative agreement.

3. The Disclosing Party will submit an updated certification at the end of each calendar quarter in which there occurs any event that materially affects the accuracy of the statements and information set forth in paragraphs A.1. and A.2. above.

4. The Disclosing Party certifies that either: (i) it is not an organization described in section 501(c)(4) of the Internal Revenue Code of 1986; or (ii) it is an organization described in section 501(c)(4) of the Internal Revenue Code of 1986 but has not engaged and will not engage in "Lobbying Activities".

5. If the Disclosing Party is the Applicant, the Disclosing Party must obtain certifications equal in form and substance to paragraphs A.1. through A.4. above from all subcontractors before it awards any subcontract and the Disclosing Party must maintain all such subcontractors' certifications for the duration of the Matter and must make such certifications promptly available to the City upon request.

B. CERTIFICATION REGARDING EQUAL EMPLOYMENT OPPORTUNITY

If the Matter is federally funded, federal regulations require the Applicant and all proposed subcontractors to submit the following information with their bids or in writing at the outset of negotiations.

Is the Disclosing Party the Applicant?

Yes No

If "Yes," answer the three questions below:

1. Have you developed and do you have on file affirmative action programs pursuant to applicable federal regulations? (See 41 CFR Part 60-2.)

Yes No

2. Have you filed with the Joint Reporting Committee, the Director of the Office of Federal Contract Compliance Programs, or the Equal Employment Opportunity Commission all reports due under the applicable filing requirements?

Yes No

3. Have you participated in any previous contracts or subcontracts subject to the equal opportunity clause?

Yes No

If you checked "No" to question 1. or 2. above, please provide an explanation:

SECTION VII -- ACKNOWLEDGMENTS, CONTRACT INCORPORATION, COMPLIANCE, PENALTIES, DISCLOSURE

The Disclosing Party understands and agrees that:

A. The certifications, disclosures, and acknowledgments contained in this EDS will become part of any contract or other agreement between the Applicant and the City in connection with the Matter, whether procurement, City assistance, or other City action, and are material inducements to the City's execution of any contract or taking other action with respect to the Matter. The Disclosing Party understands that it must comply with all statutes, ordinances, and regulations on which this EDS is based.

B. The City's Governmental Ethics and Campaign Financing Ordinances, Chapters 2-156 and 2-164 of the Municipal Code, impose certain duties and obligations on persons or entities seeking City contracts, work, business, or transactions. The full text of these ordinances and a training program is available on line at www.cityofchicago.org/Ethics, and may also be obtained from the City's Board of Ethics, 740 N.

Sedgwick St., Suite 500, Chicago, IL 60610, (312) 744-9660. The Disclosing Party must comply fully with the applicable ordinances.

C. If the City determines that any information provided in this EDS is false, incomplete or inaccurate, any contract or other agreement in connection with which it is submitted may be rescinded or be void or voidable, and the City may pursue any remedies under the contract or agreement (if not rescinded or void), at law, or in equity, including terminating the Disclosing Party's participation in the Matter and/or declining to allow the Disclosing Party to participate in other transactions with the City. Remedies at law for a false statement of material fact may include incarceration and an award to the City of treble damages.

D. It is the City's policy to make this document available to the public on its Internet site and/or upon request. Some or all of the information provided on this EDS and any attachments to this EDS may be made available to the public on the Internet, in response to a Freedom of Information Act request, or otherwise. By completing and signing this EDS, the Disclosing Party waives and releases any possible rights or claims which it may have against the City in connection with the public release of information contained in this EDS and also authorizes the City to verify the accuracy of any information submitted in this EDS.

E. The information provided in this EDS must be kept current. In the event of changes, the Disclosing Party must supplement this EDS up to the time the City takes action on the Matter. If the Matter is a contract being handled by the City's Department of Procurement Services, the Disclosing Party must update this EDS as the contract requires. **NOTE:** With respect to Matters subject to Article I of Chapter 1-23 of the Municipal Code (imposing **PERMANENT INELIGIBILITY** for certain specified offenses), the information provided herein regarding eligibility must be kept current for a longer period, as required by Chapter 1-23 and Section 2-154-020 of the Municipal Code.

The Disclosing Party represents and warrants that:

F.1. The Disclosing Party is not delinquent in the payment of any tax administered by the Illinois Department of Revenue, nor are the Disclosing Party or its Affiliated Entities delinquent in paying any fine, fee, tax or other charge owed to the City. This includes, but is not limited to, all water charges, sewer charges, license fees, parking tickets, property taxes or sales taxes.

F.2 If the Disclosing Party is the Applicant, the Disclosing Party and its Affiliated Entities will not use, nor permit their subcontractors to use, any facility listed by the U.S. E.P.A. on the federal Excluded Parties List System ("EPLS") maintained by the U. S. General Services Administration.

F.3 If the Disclosing Party is the Applicant, the Disclosing Party will obtain from any contractors/subcontractors hired or to be hired in connection with the Matter certifications equal in form and substance to those in F.1. and F.2. above and will not, without the prior written consent of the City, use any such contractor/subcontractor that does not provide such certifications or that the Disclosing Party has reason to believe has not provided or cannot provide truthful certifications.

NOTE: If the Disclosing Party cannot certify as to any of the items in F.1., F.2. or F.3. above, an explanatory statement must be attached to this EDS.

CERTIFICATION

Under penalty of perjury, the person signing below: (1) warrants that he/she is authorized to execute this EDS and Appendix A (if applicable) on behalf of the Disclosing Party, and (2) warrants that all certifications and statements contained in this EDS and Appendix A (if applicable) are true, accurate and complete as of the date furnished to the City.

Marillac Social Center

(Print or type name of Disclosing Party)

By: Bart Winters
(Sign here)

Bart Winters

(Print or type name of person signing)

Chief Executive Officer

(Print or type title of person signing)

Signed and sworn to before me on (date) 12-17-12,
at Cook County, Illinois (state).

Nancy Q. Gill Notary Public.

Commission expires: 4-19-14.

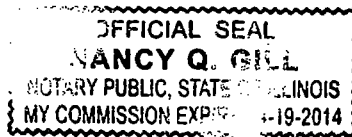

**CITY OF CHICAGO
ECONOMIC DISCLOSURE STATEMENT AND AFFIDAVIT
APPENDIX A**

FAMILIAL RELATIONSHIPS WITH ELECTED CITY OFFICIALS AND DEPARTMENT HEADS

This Appendix is to be completed only by (a) the Applicant, and (b) any legal entity which has a direct ownership interest in the Applicant exceeding 7.5 percent. It is not to be completed by any legal entity which has only an indirect ownership interest in the Applicant.

Under Municipal Code Section 2-154-015, the Disclosing Party must disclose whether such Disclosing Party or any "Applicable Party" or any Spouse or Domestic Partner thereof currently has a "familial relationship" with any elected city official or department head. A "familial relationship" exists if, as of the date this EDS is signed, the Disclosing Party or any "Applicable Party" or any Spouse or Domestic Partner thereof is related to the mayor, any alderman, the city clerk, the city treasurer or any city department head as spouse or domestic partner or as any of the following, whether by blood or adoption: parent, child, brother or sister, aunt or uncle, niece or nephew, grandparent, grandchild, father-in-law, mother-in-law, son-in-law, daughter-in-law, stepfather or stepmother, stepson or stepdaughter, stepbrother or stepsister or half-brother or half-sister.

"Applicable Party" means (1) all executive officers of the Disclosing Party listed in Section II.B.1.a., if the Disclosing Party is a corporation; all partners of the Disclosing Party, if the Disclosing Party is a general partnership; all general partners and limited partners of the Disclosing Party, if the Disclosing Party is a limited partnership; all managers, managing members and members of the Disclosing Party, if the Disclosing Party is a limited liability company; (2) all principal officers of the Disclosing Party; and (3) any person having more than a 7.5 percent ownership interest in the Disclosing Party. "Principal officers" means the president, chief operating officer, executive director, chief financial officer, treasurer or secretary of a legal entity or any person exercising similar authority.

Does the Disclosing Party or any "Applicable Party" or any Spouse or Domestic Partner thereof currently have a "familial relationship" with an elected city official or department head?

Yes

No

If yes, please identify below (1) the name and title of such person, (2) the name of the legal entity to which such person is connected; (3) the name and title of the elected city official or department head to whom such person has a familial relationship, and (4) the precise nature of such familial relationship.

**CITY OF CHICAGO
ECONOMIC DISCLOSURE STATEMENT
AND AFFIDAVIT**

SECTION I -- GENERAL INFORMATION

A. Legal name of the Disclosing Party submitting this EDS. Include d/b/a/ if applicable:

Daughters of Charity Ministries, Inc.

Check ONE of the following three boxes:

Indicate whether the Disclosing Party submitting this EDS is:

1. ~~the Applicant~~ Property Owner
OR

2. a legal entity holding a direct or indirect interest in the Applicant. State the legal name of the Applicant in which the Disclosing Party holds an interest: _____
OR

3. a legal entity with a right of control (see Section II.B.1.) State the legal name of the entity in which the Disclosing Party holds a right of control: _____

B. Business address of the Disclosing Party: 4330 Olive Street
St. Louis, Missouri 63108

C. Telephone: 314-561-4601 Fax: 314-561-4676 Email: tom.beck@doc.org

D. Name of contact person: Thomas M. Beck

E. Federal Employer Identification No. (if you have one): _____

F. Brief description of contract, transaction or other undertaking (referred to below as the "Matter") to which this EDS pertains. (Include project number and location of property, if applicable):

Zoning Amendment Application for 2847 West Jackson Blvd.

G. Which City agency or department is requesting this EDS? Dept. of Housing and
Economic Development

If the Matter is a contract being handled by the City's Department of Procurement Services, please complete the following:

Specification # _____ and Contract # _____

SECTION II -- DISCLOSURE OF OWNERSHIP INTERESTS

A. NATURE OF THE DISCLOSING PARTY

1. Indicate the nature of the Disclosing Party:

- | | |
|---|---|
| <input type="checkbox"/> Person | <input type="checkbox"/> Limited liability company |
| <input type="checkbox"/> Publicly registered business corporation | <input type="checkbox"/> Limited liability partnership |
| <input type="checkbox"/> Privately held business corporation | <input type="checkbox"/> Joint venture |
| <input type="checkbox"/> Sole proprietorship | <input checked="" type="checkbox"/> Not-for-profit corporation |
| <input type="checkbox"/> General partnership | (Is the not-for-profit corporation also a 501(c)(3))? |
| <input type="checkbox"/> Limited partnership | <input checked="" type="checkbox"/> Yes <input type="checkbox"/> No |
| <input type="checkbox"/> Trust | <input type="checkbox"/> Other (please specify) |
-

2. For legal entities, the state (or foreign country) of incorporation or organization, if applicable:

Missouri

3. For legal entities not organized in the State of Illinois: Has the organization registered to do business in the State of Illinois as a foreign entity?

- Yes No N/A

B. IF THE DISCLOSING PARTY IS A LEGAL ENTITY:

1. List below the full names and titles of all executive officers and all directors of the entity.

NOTE: For not-for-profit corporations, also list below all members, if any, which are legal entities. If there are no such members, write "no members." For trusts, estates or other similar entities, list below the legal titleholder(s).

If the entity is a general partnership, limited partnership, limited liability company, limited liability partnership or joint venture, list below the name and title of each general partner, managing member, manager or any other person or entity that controls the day-to-day management of the Disclosing Party. **NOTE:** Each legal entity listed below must submit an EDS on its own behalf.

Name	Title
<u>Please See Attached List</u>	
<hr/>	
<hr/>	
<hr/>	

2. Please provide the following information concerning each person or entity having a direct or indirect beneficial interest (including ownership) in excess of 7.5% of the Disclosing Party. Examples of such an interest include shares in a corporation, partnership interest in a partnership or joint venture,

interest of a member or manager in a limited liability company, or interest of a beneficiary of a trust, estate or other similar entity. If none, state "None." **NOTE:** Pursuant to Section 2-154-030 of the Municipal Code of Chicago ("Municipal Code"), the City may require any such additional information from any applicant which is reasonably intended to achieve full disclosure.

Name	Business Address	Percentage Interest in the Disclosing Party
Daughters of Charity, Inc.	4330 Olive Street	100%
	St. Louis, MO 63108	

SECTION III -- BUSINESS RELATIONSHIPS WITH CITY ELECTED OFFICIALS

Has the Disclosing Party had a "business relationship," as defined in Chapter 2-156 of the Municipal Code, with any City elected official in the 12 months before the date this EDS is signed?

Yes No

If yes, please identify below the name(s) of such City elected official(s) and describe such relationship(s):

SECTION IV -- DISCLOSURE OF SUBCONTRACTORS AND OTHER RETAINED PARTIES

The Disclosing Party must disclose the name and business address of each subcontractor, attorney, lobbyist, accountant, consultant and any other person or entity whom the Disclosing Party has retained or expects to retain in connection with the Matter, as well as the nature of the relationship, and the total amount of the fees paid or estimated to be paid. The Disclosing Party is not required to disclose employees who are paid solely through the Disclosing Party's regular payroll.

"Lobbyist" means any person or entity who undertakes to influence any legislative or administrative action on behalf of any person or entity other than: (1) a not-for-profit entity, on an unpaid basis, or (2) himself. "Lobbyist" also means any person or entity any part of whose duties as an employee of another includes undertaking to influence any legislative or administrative action.

If the Disclosing Party is uncertain whether a disclosure is required under this Section, the Disclosing Party must either ask the City whether disclosure is required or make the disclosure.

Name (indicate whether retained or anticipated to be retained)	Business Address	Relationship to Disclosing Party (subcontractor, attorney, lobbyist, etc.)	Fees (indicate whether paid or estimated.) NOTE: "hourly rate" or "t.b.d." is not an acceptable response.
NONE			

(Add sheets if necessary)

Check here if the Disclosing Party has not retained, nor expects to retain, any such persons or entities.

SECTION V -- CERTIFICATIONS

A. COURT-ORDERED CHILD SUPPORT COMPLIANCE

Under Municipal Code Section 2-92-415, substantial owners of business entities that contract with the City must remain in compliance with their child support obligations throughout the contract's term.

Has any person who directly or indirectly owns 10% or more of the Disclosing Party been declared in arrearage on any child support obligations by any Illinois court of competent jurisdiction?

Yes No No person directly or indirectly owns 10% or more of the Disclosing Party.

If "Yes," has the person entered into a court-approved agreement for payment of all support owed and is the person in compliance with that agreement?

Yes No

B. FURTHER CERTIFICATIONS

1. Pursuant to Municipal Code Chapter 1-23, Article I ("Article I")(which the Applicant should consult for defined terms (e.g., "doing business") and legal requirements), if the Disclosing Party submitting this EDS is the Applicant and is doing business with the City, then the Disclosing Party certifies as follows: (i) neither the Applicant nor any controlling person is currently indicted or charged with, or has admitted guilt of, or has ever been convicted of, or placed under supervision for, any criminal offense involving actual, attempted, or conspiracy to commit bribery, theft, fraud, forgery, perjury, dishonesty or deceit against an officer or employee of the City or any sister agency; and (ii) the Applicant understands and acknowledges that compliance with Article I is a continuing requirement for doing business with the City. **NOTE:** If Article I applies to the Applicant, the permanent compliance timeframe in Article I supersedes some five-year compliance timeframes in certifications 2 and 3 below.

2. The Disclosing Party and, if the Disclosing Party is a legal entity, all of those persons or entities identified in Section II.B.1. of this EDS:

- a. are not presently debarred, suspended, proposed for debarment, declared ineligible or voluntarily excluded from any transactions by any federal, state or local unit of government;
- b. have not, within a five-year period preceding the date of this EDS, been convicted of a criminal offense, adjudged guilty, or had a civil judgment rendered against them in connection with: obtaining, attempting to obtain, or performing a public (federal, state or local) transaction or contract under a public transaction; a violation of federal or state antitrust statutes; fraud; embezzlement; theft; forgery; bribery; falsification or destruction of records; making false statements; or receiving stolen property;
- c. are not presently indicted for, or criminally or civilly charged by, a governmental entity (federal, state or local) with committing any of the offenses set forth in clause B.2.b. of this Section V;
- d. have not, within a five-year period preceding the date of this EDS, had one or more public transactions (federal, state or local) terminated for cause or default; and
- e. have not, within a five-year period preceding the date of this EDS, been convicted, adjudged guilty, or found liable in a civil proceeding, or in any criminal or civil action, including actions concerning environmental violations, instituted by the City or by the federal government, any state, or any other unit of local government.

3. The certifications in subparts 3, 4 and 5 concern:

- the Disclosing Party;
- any "Contractor" (meaning any contractor or subcontractor used by the Disclosing Party in connection with the Matter, including but not limited to all persons or legal entities disclosed under Section IV, "Disclosure of Subcontractors and Other Retained Parties");
- any "Affiliated Entity" (meaning a person or entity that, directly or indirectly: controls the Disclosing Party, is controlled by the Disclosing Party, or is, with the Disclosing Party, under common control of another person or entity. Indicia of control include, without limitation: interlocking management or ownership; identity of interests among family members, shared facilities and equipment; common use of employees; or organization of a business entity following the ineligibility of a business entity to do business with federal or state or local government, including the City, using substantially the same management, ownership, or principals as the ineligible entity); with respect to Contractors, the term Affiliated Entity means a person or entity that directly or indirectly controls the Contractor, is controlled by it, or, with the Contractor, is under common control of another person or entity;
- any responsible official of the Disclosing Party, any Contractor or any Affiliated Entity or any other official, agent or employee of the Disclosing Party, any Contractor or any Affiliated Entity, acting pursuant to the direction or authorization of a responsible official of the Disclosing Party, any Contractor or any Affiliated Entity (collectively "Agents").

Neither the Disclosing Party, nor any Contractor, nor any Affiliated Entity of either the Disclosing Party or any Contractor nor any Agents have, during the five years before the date this EDS is signed, or, with respect to a Contractor, an Affiliated Entity, or an Affiliated Entity of a Contractor during the five years before the date of such Contractor's or Affiliated Entity's contract or engagement in connection with the Matter:

- a. bribed or attempted to bribe, or been convicted or adjudged guilty of bribery or attempting to bribe, a public officer or employee of the City, the State of Illinois, or any agency of the federal government or of any state or local government in the United States of America, in that officer's or employee's official capacity;
- b. agreed or colluded with other bidders or prospective bidders, or been a party to any such agreement, or been convicted or adjudged guilty of agreement or collusion among bidders or prospective bidders, in restraint of freedom of competition by agreement to bid a fixed price or otherwise; or
- c. made an admission of such conduct described in a. or b. above that is a matter of record, but have not been prosecuted for such conduct; or
- d. violated the provisions of Municipal Code Section 2-92-610 (Living Wage Ordinance).

4. Neither the Disclosing Party, Affiliated Entity or Contractor, or any of their employees, officials, agents or partners, is barred from contracting with any unit of state or local government as a result of engaging in or being convicted of (1) bid-rigging in violation of 720 ILCS 5/33E-3; (2) bid-rotating in violation of 720 ILCS 5/33E-4; or (3) any similar offense of any state or of the United States of America that contains the same elements as the offense of bid-rigging or bid-rotating.

5. Neither the Disclosing Party nor any Affiliated Entity is listed on any of the following lists maintained by the Office of Foreign Assets Control of the U.S. Department of the Treasury or the Bureau of Industry and Security of the U.S. Department of Commerce or their successors: the Specially Designated Nationals List, the Denied Persons List, the Unverified List, the Entity List and the Debarred List.

6. The Disclosing Party understands and shall comply with the applicable requirements of Chapters 2-55 (Legislative Inspector General), 2-56 (Inspector General) and 2-156 (Governmental Ethics) of the Municipal Code.

7. If the Disclosing Party is unable to certify to any of the above statements in this Part B (Further Certifications), the Disclosing Party must explain below:

NONE

If the letters "NA," the word "None," or no response appears on the lines above, it will be conclusively presumed that the Disclosing Party certified to the above statements.

8. To the best of the Disclosing Party's knowledge after reasonable inquiry, the following is a complete list of all current employees of the Disclosing Party who were, at any time during the 12-month period preceding the execution date of this EDS, an employee, or elected or appointed official, of the City of Chicago (if none, indicate with "N/A" or "none").

NONE

9. To the best of the Disclosing Party's knowledge after reasonable inquiry, the following is a complete list of all gifts that the Disclosing Party has given or caused to be given, at any time during the 12-month period preceding the execution date of this EDS, to an employee, or elected or appointed official, of the City of Chicago. For purposes of this statement, a "gift" does not include: (i) anything made generally available to City employees or to the general public, or (ii) food or drink provided in the course of official City business and having a retail value of less than \$20 per recipient (if none, indicate with "N/A" or "none"). As to any gift listed below, please also list the name of the City recipient.

NONE

C. CERTIFICATION OF STATUS AS FINANCIAL INSTITUTION

1. The Disclosing Party certifies that the Disclosing Party (check one)

is is not

a "financial institution" as defined in Section 2-32-455(b) of the Municipal Code.

2. If the Disclosing Party IS a financial institution, then the Disclosing Party pledges:

"We are not and will not become a predatory lender as defined in Chapter 2-32 of the Municipal Code. We further pledge that none of our affiliates is, and none of them will become, a predatory lender as defined in Chapter 2-32 of the Municipal Code. We understand that becoming a predatory lender or becoming an affiliate of a predatory lender may result in the loss of the privilege of doing business with the City."

If the Disclosing Party is unable to make this pledge because it or any of its affiliates (as defined in Section 2-32-455(b) of the Municipal Code) is a predatory lender within the meaning of Chapter 2-32 of the Municipal Code, explain here (attach additional pages if necessary):

If the letters "NA," the word "None," or no response appears on the lines above, it will be conclusively presumed that the Disclosing Party certified to the above statements.

D. CERTIFICATION REGARDING INTEREST IN CITY BUSINESS

Any words or terms that are defined in Chapter 2-156 of the Municipal Code have the same meanings when used in this Part D.

1. In accordance with Section 2-156-110 of the Municipal Code: Does any official or employee of the City have a financial interest in his or her own name or in the name of any other person or entity in the Matter?

Yes No

NOTE: If you checked "Yes" to Item D.1., proceed to Items D.2. and D.3. If you checked "No" to Item D.1., proceed to Part E.

2. Unless sold pursuant to a process of competitive bidding, or otherwise permitted, no City elected official or employee shall have a financial interest in his or her own name or in the name of any other person or entity in the purchase of any property that (i) belongs to the City, or (ii) is sold for taxes or assessments, or (iii) is sold by virtue of legal process at the suit of the City (collectively, "City Property Sale"). Compensation for property taken pursuant to the City's eminent domain power does not constitute a financial interest within the meaning of this Part D.

Does the Matter involve a City Property Sale?

Yes No

3. If you checked "Yes" to Item D.1., provide the names and business addresses of the City officials or employees having such interest and identify the nature of such interest:

Name	Business Address	Nature of Interest

4. The Disclosing Party further certifies that no prohibited financial interest in the Matter will be acquired by any City official or employee.

E. CERTIFICATION REGARDING SLAVERY ERA BUSINESS

Please check either 1. or 2. below. If the Disclosing Party checks 2., the Disclosing Party must disclose below or in an attachment to this EDS all information required by paragraph 2. Failure to

comply with these disclosure requirements may make any contract entered into with the City in connection with the Matter voidable by the City.

X 1. The Disclosing Party verifies that the Disclosing Party has searched any and all records of the Disclosing Party and any and all predecessor entities regarding records of investments or profits from slavery or slaveholder insurance policies during the slavery era (including insurance policies issued to slaveholders that provided coverage for damage to or injury or death of their slaves), and the Disclosing Party has found no such records.

____ 2. The Disclosing Party verifies that, as a result of conducting the search in step 1 above, the Disclosing Party has found records of investments or profits from slavery or slaveholder insurance policies. The Disclosing Party verifies that the following constitutes full disclosure of all such records, including the names of any and all slaves or slaveholders described in those records:

SECTION VI -- CERTIFICATIONS FOR FEDERALLY FUNDED MATTERS

NOTE: If the Matter is federally funded, complete this Section VI. **If the Matter is not federally funded**, proceed to Section VII. For purposes of this Section VI, tax credits allocated by the City and proceeds of debt obligations of the City are not federal funding.

A. CERTIFICATION REGARDING LOBBYING

1. List below the names of all persons or entities registered under the federal Lobbying Disclosure Act of 1995 who have made lobbying contacts on behalf of the Disclosing Party with respect to the Matter: (Add sheets if necessary):

(If no explanation appears or begins on the lines above, or if the letters "NA" or if the word "None" appear, it will be conclusively presumed that the Disclosing Party means that NO persons or entities registered under the Lobbying Disclosure Act of 1995 have made lobbying contacts on behalf of the Disclosing Party with respect to the Matter.)

2. The Disclosing Party has not spent and will not expend any federally appropriated funds to pay any person or entity listed in Paragraph A.1. above for his or her lobbying activities or to pay any person or entity to influence or attempt to influence an officer or employee of any agency, as defined by applicable federal law, a member of Congress, an officer or employee of Congress, or an employee of a member of Congress, in connection with the award of any federally funded contract, making any federally funded grant or loan, entering into any cooperative agreement, or to extend, continue, renew, amend, or modify any federally funded contract, grant, loan, or cooperative agreement.

3. The Disclosing Party will submit an updated certification at the end of each calendar quarter in which there occurs any event that materially affects the accuracy of the statements and information set forth in paragraphs A.1. and A.2. above.

4. The Disclosing Party certifies that either: (i) it is not an organization described in section 501(c)(4) of the Internal Revenue Code of 1986; or (ii) it is an organization described in section 501(c)(4) of the Internal Revenue Code of 1986 but has not engaged and will not engage in "Lobbying Activities".

5. If the Disclosing Party is the Applicant, the Disclosing Party must obtain certifications equal in form and substance to paragraphs A.1. through A.4. above from all subcontractors before it awards any subcontract and the Disclosing Party must maintain all such subcontractors' certifications for the duration of the Matter and must make such certifications promptly available to the City upon request.

B. CERTIFICATION REGARDING EQUAL EMPLOYMENT OPPORTUNITY

If the Matter is federally funded, federal regulations require the Applicant and all proposed subcontractors to submit the following information with their bids or in writing at the outset of negotiations.

Is the Disclosing Party the Applicant?

Yes No

If "Yes," answer the three questions below:

1. Have you developed and do you have on file affirmative action programs pursuant to applicable federal regulations? (Sec 41 CFR Part 60-2.)

Yes No

2. Have you filed with the Joint Reporting Committee, the Director of the Office of Federal Contract Compliance Programs, or the Equal Employment Opportunity Commission all reports due under the applicable filing requirements?

Yes No

3. Have you participated in any previous contracts or subcontracts subject to the equal opportunity clause?

Yes No

If you checked "No" to question 1. or 2. above, please provide an explanation:

SECTION VII -- ACKNOWLEDGMENTS, CONTRACT INCORPORATION, COMPLIANCE, PENALTIES, DISCLOSURE

The Disclosing Party understands and agrees that:

A. The certifications, disclosures, and acknowledgments contained in this EDS will become part of any contract or other agreement between the Applicant and the City in connection with the Matter, whether procurement, City assistance, or other City action, and are material inducements to the City's execution of any contract or taking other action with respect to the Matter. The Disclosing Party understands that it must comply with all statutes, ordinances, and regulations on which this EDS is based.

B. The City's Governmental Ethics and Campaign Financing Ordinances, Chapters 2-156 and 2-164 of the Municipal Code, impose certain duties and obligations on persons or entities seeking City contracts, work, business, or transactions. The full text of these ordinances and a training program is available on line at www.cityofchicago.org/Ethics, and may also be obtained from the City's Board of Ethics, 740 N.

Sedgwick St., Suite 500, Chicago, IL 60610, (312) 744-9660. The Disclosing Party must comply fully with the applicable ordinances.

C. If the City determines that any information provided in this EDS is false, incomplete or inaccurate, any contract or other agreement in connection with which it is submitted may be rescinded or be void or voidable, and the City may pursue any remedies under the contract or agreement (if not rescinded or void), at law, or in equity, including terminating the Disclosing Party's participation in the Matter and/or declining to allow the Disclosing Party to participate in other transactions with the City. Remedies at law for a false statement of material fact may include incarceration and an award to the City of treble damages.

D. It is the City's policy to make this document available to the public on its Internet site and/or upon request. Some or all of the information provided on this EDS and any attachments to this EDS may be made available to the public on the Internet, in response to a Freedom of Information Act request, or otherwise. By completing and signing this EDS, the Disclosing Party waives and releases any possible rights or claims which it may have against the City in connection with the public release of information contained in this EDS and also authorizes the City to verify the accuracy of any information submitted in this EDS.

E. The information provided in this EDS must be kept current. In the event of changes, the Disclosing Party must supplement this EDS up to the time the City takes action on the Matter. If the Matter is a contract being handled by the City's Department of Procurement Services, the Disclosing Party must update this EDS as the contract requires. **NOTE:** With respect to Matters subject to Article I of Chapter 1-23 of the Municipal Code (imposing **PERMANENT INELIGIBILITY** for certain specified offenses), the information provided herein regarding eligibility must be kept current for a longer period, as required by Chapter 1-23 and Section 2-154-020 of the Municipal Code.

The Disclosing Party represents and warrants that:

F.1. The Disclosing Party is not delinquent in the payment of any tax administered by the Illinois Department of Revenue, nor are the Disclosing Party or its Affiliated Entities delinquent in paying any fine, fee, tax or other charge owed to the City. This includes, but is not limited to, all water charges, sewer charges, license fees, parking tickets, property taxes or sales taxes.

F.2 If the Disclosing Party is the Applicant, the Disclosing Party and its Affiliated Entities will not use, nor permit their subcontractors to use, any facility listed by the U.S. E.P.A. on the federal Excluded Parties List System ("EPLS") maintained by the U. S. General Services Administration.

F.3 If the Disclosing Party is the Applicant, the Disclosing Party will obtain from any contractors/subcontractors hired or to be hired in connection with the Matter certifications equal in form and substance to those in F.1. and F.2. above and will not, without the prior written consent of the City, use any such contractor/subcontractor that does not provide such certifications or that the Disclosing Party has reason to believe has not provided or cannot provide truthful certifications.

NOTE: If the Disclosing Party cannot certify as to any of the items in F.1., F.2. or F.3. above, an explanatory statement must be attached to this EDS.

CERTIFICATION

Under penalty of perjury, the person signing below: (1) warrants that he/she is authorized to execute this EDS and Appendix A (if applicable) on behalf of the Disclosing Party, and (2) warrants that all certifications and statements contained in this EDS and Appendix A (if applicable) are true, accurate and complete as of the date furnished to the City.

Daughters of Charity Ministries, Inc.

(Print or type name of Disclosing Party)

By: *Thomas M Beck*
(Sign here)

Thomas M. Beck

(Print or type name of person signing)

CFO

(Print or type title of person signing)

Signed and sworn to before me on (date) 12/21/2012,
at St. Louis County, MO (state).

J. Rachford Notary Public.

Commission expires: Jan. 14, 2013.

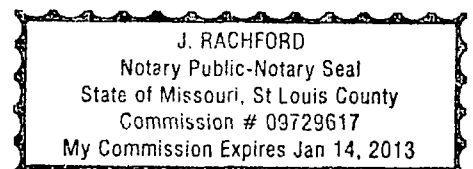

**CITY OF CHICAGO
ECONOMIC DISCLOSURE STATEMENT AND AFFIDAVIT
APPENDIX A**

FAMILIAL RELATIONSHIPS WITH ELECTED CITY OFFICIALS AND DEPARTMENT HEADS

This Appendix is to be completed only by (a) the Applicant, and (b) any legal entity which has a direct ownership interest in the Applicant exceeding 7.5 percent. It is not to be completed by any legal entity which has only an indirect ownership interest in the Applicant.

Under Municipal Code Section 2-154-015, the Disclosing Party must disclose whether such Disclosing Party or any "Applicable Party" or any Spouse or Domestic Partner thereof currently has a "familial relationship" with any elected city official or department head. A "familial relationship" exists if, as of the date this EDS is signed, the Disclosing Party or any "Applicable Party" or any Spouse or Domestic Partner thereof is related to the mayor, any alderman, the city clerk, the city treasurer or any city department head as spouse or domestic partner or as any of the following, whether by blood or adoption: parent, child, brother or sister, aunt or uncle, niece or nephew, grandparent, grandchild, father-in-law, mother-in-law, son-in-law, daughter-in-law, stepfather or stepmother, stepson or stepdaughter, stepbrother or stepsister or half-brother or half-sister.

"Applicable Party" means (1) all executive officers of the Disclosing Party listed in Section II.B.1.a., if the Disclosing Party is a corporation; all partners of the Disclosing Party, if the Disclosing Party is a general partnership; all general partners and limited partners of the Disclosing Party, if the Disclosing Party is a limited partnership; all managers, managing members and members of the Disclosing Party, if the Disclosing Party is a limited liability company; (2) all principal officers of the Disclosing Party; and (3) any person having more than a 7.5 percent ownership interest in the Disclosing Party. "Principal officers" means the president, chief operating officer, executive director, chief financial officer, treasurer or secretary of a legal entity or any person exercising similar authority.

Does the Disclosing Party or any "Applicable Party" or any Spouse or Domestic Partner thereof currently have a "familial relationship" with an elected city official or department head?

Yes

No

If yes, please identify below (1) the name and title of such person, (2) the name of the legal entity to which such person is connected; (3) the name and title of the elected city official or department head to whom such person has a familial relationship, and (4) the precise nature of such familial relationship.

Attachment

City of Chicago
Economic Disclosure Statement and Affidavit

Daughters of Charity Ministries, Inc.
4330 Olive Street
St. Louis, Missouri 63108

SECTION II.B. – Names and titles of all executive officers and all directors of the Daughters of Charity Ministries, Inc. Also listed is the sole corporate member of Daughters of Charity Ministries, Inc.

Name	Title
Sister Louise Gallahue	President / Chair / Director
Sister Mary Walz	Vice Chair / Director
Sister Jane Graves	Secretary / Treasurer / Director
Sister Rose Ann Aguilar	Director
Sister Nora Gatto	Director
Sister Janet Keim	Director
Sister Mary Beth Kubera	Director
Sister Jean Rhoads	Director
Sister Joanne Vasa	Director
Sister Mary Catherine Warehime	Director
Sister Maureen Schmalzried	Assistant Secretary
Thomas M. Beck	Chief Financial Officer
Daughters of Charity, Inc.	Sole Corporate Member

**CITY OF CHICAGO
ECONOMIC DISCLOSURE STATEMENT
AND AFFIDAVIT**

SECTION I -- GENERAL INFORMATION

A. Legal name of the Disclosing Party submitting this EDS. Include d/b/a/ if applicable:

Daughters of Charity, Inc.

Check ONE of the following three boxes:

Indicate whether the Disclosing Party submitting this EDS is:

1. the Applicant

OR

2. a legal entity holding a direct or indirect interest in the Applicant. State the legal name of the Applicant in which the Disclosing Party holds an interest: Daughters of Charity

OR

Ministries, Inc.

3. a legal entity with a right of control (see Section II.B.1.) State the legal name of the entity in which the Disclosing Party holds a right of control: _____

B. Business address of the Disclosing Party:

4330 Olive Street

St. Louis, Missouri 63108

C. Telephone: 314-561-4601 Fax: 314-561-4676 Email: tom.beck@doc.org

D. Name of contact person: Thomas M. Beck

E. Federal Employer Identification No. (if you have one): _____

F. Brief description of contract, transaction or other undertaking (referred to below as the "Matter") to which this EDS pertains. (Include project number and location of property, if applicable):

Zoning Amendment Application for 2847 West Jackson Blvd.

G. Which City agency or department is requesting this EDS? Dept. of Housing and
Economic Development

If the Matter is a contract being handled by the City's Department of Procurement Services, please complete the following:

Specification # _____ and Contract # _____

SECTION II -- DISCLOSURE OF OWNERSHIP INTERESTS

A. NATURE OF THE DISCLOSING PARTY

1. Indicate the nature of the Disclosing Party:

- Person
- Publicly registered business corporation
- Privately held business corporation
- Sole proprietorship
- General partnership
- Limited partnership
- Trust
- Limited liability company
- Limited liability partnership
- Joint venture
- Not-for-profit corporation
(Is the not-for-profit corporation also a 501(c)(3))?
 Yes No
- Other (please specify)

2. For legal entities, the state (or foreign country) of incorporation or organization, if applicable:

Missouri

3. For legal entities not organized in the State of Illinois: Has the organization registered to do business in the State of Illinois as a foreign entity?

- Yes No N/A

B. IF THE DISCLOSING PARTY IS A LEGAL ENTITY:

1. List below the full names and titles of all executive officers and all directors of the entity.

NOTE: For not-for-profit corporations, also list below all members, if any, which are legal entities. If there are no such members, write "no members." For trusts, estates or other similar entities, list below the legal titleholder(s).

If the entity is a general partnership, limited partnership, limited liability company, limited liability partnership or joint venture, list below the name and title of each general partner, managing member, manager or any other person or entity that controls the day-to-day management of the Disclosing Party. **NOTE:** Each legal entity listed below must submit an EDS on its own behalf.

Name	Title
<u>Please See Attached List</u>	

2. Please provide the following information concerning each person or entity having a direct or indirect beneficial interest (including ownership) in excess of 7.5% of the Disclosing Party. Examples of such an interest include shares in a corporation, partnership interest in a partnership or joint venture,

interest of a member or manager in a limited liability company, or interest of a beneficiary of a trust, estate or other similar entity. If none, state "None." **NOTE:** Pursuant to Section 2-154-030 of the Municipal Code of Chicago ("Municipal Code"), the City may require any such additional information from any applicant which is reasonably intended to achieve full disclosure.

Name	Business Address	Percentage Interest in the Disclosing Party
NONE		

SECTION III -- BUSINESS RELATIONSHIPS WITH CITY ELECTED OFFICIALS

Has the Disclosing Party had a "business relationship," as defined in Chapter 2-156 of the Municipal Code, with any City elected official in the 12 months before the date this EDS is signed?

Yes No

If yes, please identify below the name(s) of such City elected official(s) and describe such relationship(s):

SECTION IV -- DISCLOSURE OF SUBCONTRACTORS AND OTHER RETAINED PARTIES

The Disclosing Party must disclose the name and business address of each subcontractor, attorney, lobbyist, accountant, consultant and any other person or entity whom the Disclosing Party has retained or expects to retain in connection with the Matter, as well as the nature of the relationship, and the total amount of the fees paid or estimated to be paid. The Disclosing Party is not required to disclose employees who are paid solely through the Disclosing Party's regular payroll.

"Lobbyist" means any person or entity who undertakes to influence any legislative or administrative action on behalf of any person or entity other than: (1) a not-for-profit entity, on an unpaid basis, or (2) himself. "Lobbyist" also means any person or entity any part of whose duties as an employee of another includes undertaking to influence any legislative or administrative action.

If the Disclosing Party is uncertain whether a disclosure is required under this Section, the Disclosing Party must either ask the City whether disclosure is required or make the disclosure.

Name (indicate whether retained or anticipated to be retained)	Business Address	Relationship to Disclosing Party (subcontractor, attorney, lobbyist, etc.)	Fees (indicate whether paid or estimated.) NOTE: "hourly rate" or "t.b.d." is not an acceptable response.
--	------------------	--	--

NONE

(Add sheets if necessary)

Check here if the Disclosing Party has not retained, nor expects to retain, any such persons or entities.

SECTION V -- CERTIFICATIONS

A. COURT-ORDERED CHILD SUPPORT COMPLIANCE

Under Municipal Code Section 2-92-415, substantial owners of business entities that contract with the City must remain in compliance with their child support obligations throughout the contract's term.

Has any person who directly or indirectly owns 10% or more of the Disclosing Party been declared in arrearage on any child support obligations by any Illinois court of competent jurisdiction?

Yes No No person directly or indirectly owns 10% or more of the Disclosing Party.

If "Yes," has the person entered into a court-approved agreement for payment of all support owed and is the person in compliance with that agreement?

Yes No

B. FURTHER CERTIFICATIONS

1. Pursuant to Municipal Code Chapter 1-23, Article I ("Article I")(which the Applicant should consult for defined terms (e.g., "doing business") and legal requirements), if the Disclosing Party submitting this EDS is the Applicant and is doing business with the City, then the Disclosing Party certifies as follows: (i) neither the Applicant nor any controlling person is currently indicted or charged with, or has admitted guilt of, or has ever been convicted of, or placed under supervision for, any criminal offense involving actual, attempted, or conspiracy to commit bribery, theft, fraud, forgery, perjury, dishonesty or deceit against an officer or employee of the City or any sister agency; and (ii) the Applicant understands and acknowledges that compliance with Article I is a continuing requirement for doing business with the City. **NOTE:** If Article I applies to the Applicant, the permanent compliance timeframe in Article I supersedes some five-year compliance timeframes in certifications 2 and 3 below.

2. The Disclosing Party and, if the Disclosing Party is a legal entity, all of those persons or entities identified in Section II.B.1. of this EDS:

- a. are not presently debarred, suspended, proposed for debarment, declared ineligible or voluntarily excluded from any transactions by any federal, state or local unit of government;
- b. have not, within a five-year period preceding the date of this EDS, been convicted of a criminal offense, adjudged guilty, or had a civil judgment rendered against them in connection with: obtaining, attempting to obtain, or performing a public (federal, state or local) transaction or contract under a public transaction; a violation of federal or state antitrust statutes; fraud; embezzlement; theft; forgery; bribery; falsification or destruction of records; making false statements; or receiving stolen property;
- c. are not presently indicted for, or criminally or civilly charged by, a governmental entity (federal, state or local) with committing any of the offenses set forth in clause B.2.b. of this Section V;
- d. have not, within a five-year period preceding the date of this EDS, had one or more public transactions (federal, state or local) terminated for cause or default; and
- e. have not, within a five-year period preceding the date of this EDS, been convicted, adjudged guilty, or found liable in a civil proceeding, or in any criminal or civil action, including actions concerning environmental violations, instituted by the City or by the federal government, any state, or any other unit of local government.

3. The certifications in subparts 3, 4 and 5 concern:

- the Disclosing Party;
- any "Contractor" (meaning any contractor or subcontractor used by the Disclosing Party in connection with the Matter, including but not limited to all persons or legal entities disclosed under Section IV, "Disclosure of Subcontractors and Other Retained Parties");
- any "Affiliated Entity" (meaning a person or entity that, directly or indirectly: controls the Disclosing Party, is controlled by the Disclosing Party, or is, with the Disclosing Party, under common control of another person or entity. Indicia of control include, without limitation: interlocking management or ownership; identity of interests among family members, shared facilities and equipment; common use of employees; or organization of a business entity following the ineligibility of a business entity to do business with federal or state or local government, including the City, using substantially the same management, ownership, or principals as the ineligible entity); with respect to Contractors, the term Affiliated Entity means a person or entity that directly or indirectly controls the Contractor, is controlled by it, or, with the Contractor, is under common control of another person or entity;
- any responsible official of the Disclosing Party, any Contractor or any Affiliated Entity or any other official, agent or employee of the Disclosing Party, any Contractor or any Affiliated Entity, acting pursuant to the direction or authorization of a responsible official of the Disclosing Party, any Contractor or any Affiliated Entity (collectively "Agents").

Neither the Disclosing Party, nor any Contractor, nor any Affiliated Entity of either the Disclosing Party or any Contractor nor any Agents have, during the five years before the date this EDS is signed, or, with respect to a Contractor, an Affiliated Entity, or an Affiliated Entity of a Contractor during the five years before the date of such Contractor's or Affiliated Entity's contract or engagement in connection with the Matter:

- a. bribed or attempted to bribe, or been convicted or adjudged guilty of bribery or attempting to bribe, a public officer or employee of the City, the State of Illinois, or any agency of the federal government or of any state or local government in the United States of America, in that officer's or employee's official capacity;
- b. agreed or colluded with other bidders or prospective bidders, or been a party to any such agreement, or been convicted or adjudged guilty of agreement or collusion among bidders or prospective bidders, in restraint of freedom of competition by agreement to bid a fixed price or otherwise; or
- c. made an admission of such conduct described in a. or b. above that is a matter of record, but have not been prosecuted for such conduct; or
- d. violated the provisions of Municipal Code Section 2-92-610 (Living Wage Ordinance).

4. Neither the Disclosing Party, Affiliated Entity or Contractor, or any of their employees, officials, agents or partners, is barred from contracting with any unit of state or local government as a result of engaging in or being convicted of (1) bid-rigging in violation of 720 ILCS 5/33E-3; (2) bid-rotating in violation of 720 ILCS 5/33E-4; or (3) any similar offense of any state or of the United States of America that contains the same elements as the offense of bid-rigging or bid-rotating.

5. Neither the Disclosing Party nor any Affiliated Entity is listed on any of the following lists maintained by the Office of Foreign Assets Control of the U.S. Department of the Treasury or the Bureau of Industry and Security of the U.S. Department of Commerce or their successors: the Specially Designated Nationals List, the Denied Persons List, the Unverified List, the Entity List and the Debarred List.

6. The Disclosing Party understands and shall comply with the applicable requirements of Chapters 2-55 (Legislative Inspector General), 2-56 (Inspector General) and 2-156 (Governmental Ethics) of the Municipal Code.

7. If the Disclosing Party is unable to certify to any of the above statements in this Part B (Further Certifications), the Disclosing Party must explain below:

NONE

If the letters "NA," the word "None," or no response appears on the lines above, it will be conclusively presumed that the Disclosing Party certified to the above statements.

8. To the best of the Disclosing Party's knowledge after reasonable inquiry, the following is a complete list of all current employees of the Disclosing Party who were, at any time during the 12-month period preceding the execution date of this EDS, an employee, or elected or appointed official, of the City of Chicago (if none, indicate with "N/A" or "none").

NONE

9. To the best of the Disclosing Party's knowledge after reasonable inquiry, the following is a complete list of all gifts that the Disclosing Party has given or caused to be given, at any time during the 12-month period preceding the execution date of this EDS, to an employee, or elected or appointed official, of the City of Chicago. For purposes of this statement, a "gift" does not include: (i) anything made generally available to City employees or to the general public, or (ii) food or drink provided in the course of official City business and having a retail value of less than \$20 per recipient (if none, indicate with "N/A" or "none"). As to any gift listed below, please also list the name of the City recipient.

NONE

C. CERTIFICATION OF STATUS AS FINANCIAL INSTITUTION

1. The Disclosing Party certifies that the Disclosing Party (check one)

is is not

a "financial institution" as defined in Section 2-32-455(b) of the Municipal Code.

2. If the Disclosing Party IS a financial institution, then the Disclosing Party pledges:

"We are not and will not become a predatory lender as defined in Chapter 2-32 of the Municipal Code. We further pledge that none of our affiliates is, and none of them will become, a predatory lender as defined in Chapter 2-32 of the Municipal Code. We understand that becoming a predatory lender or becoming an affiliate of a predatory lender may result in the loss of the privilege of doing business with the City."

If the Disclosing Party is unable to make this pledge because it or any of its affiliates (as defined in Section 2-32-455(b) of the Municipal Code) is a predatory lender within the meaning of Chapter 2-32 of the Municipal Code, explain here (attach additional pages if necessary):

If the letters "NA," the word "None," or no response appears on the lines above, it will be conclusively presumed that the Disclosing Party certified to the above statements.

D. CERTIFICATION REGARDING INTEREST IN CITY BUSINESS

Any words or terms that are defined in Chapter 2-156 of the Municipal Code have the same meanings when used in this Part D.

1. In accordance with Section 2-156-110 of the Municipal Code: Does any official or employee of the City have a financial interest in his or her own name or in the name of any other person or entity in the Matter?

Yes No

NOTE: If you checked "Yes" to Item D.1., proceed to Items D.2. and D.3. If you checked "No" to Item D.1., proceed to Part E.

2. Unless sold pursuant to a process of competitive bidding, or otherwise permitted, no City elected official or employee shall have a financial interest in his or her own name or in the name of any other person or entity in the purchase of any property that (i) belongs to the City, or (ii) is sold for taxes or assessments, or (iii) is sold by virtue of legal process at the suit of the City (collectively, "City Property Sale"). Compensation for property taken pursuant to the City's eminent domain power does not constitute a financial interest within the meaning of this Part D.

Does the Matter involve a City Property Sale?

Yes No

3. If you checked "Yes" to Item D.1., provide the names and business addresses of the City officials or employees having such interest and identify the nature of such interest:

Name	Business Address	Nature of Interest

4. The Disclosing Party further certifies that no prohibited financial interest in the Matter will be acquired by any City official or employee.

E. CERTIFICATION REGARDING SLAVERY ERA BUSINESS

Please check either 1. or 2. below. If the Disclosing Party checks 2., the Disclosing Party must disclose below or in an attachment to this EDS all information required by paragraph 2. Failure to

comply with these disclosure requirements may make any contract entered into with the City in connection with the Matter voidable by the City.

X 1. The Disclosing Party verifies that the Disclosing Party has searched any and all records of the Disclosing Party and any and all predecessor entities regarding records of investments or profits from slavery or slaveholder insurance policies during the slavery era (including insurance policies issued to slaveholders that provided coverage for damage to or injury or death of their slaves), and the Disclosing Party has found no such records.

____ 2. The Disclosing Party verifies that, as a result of conducting the search in step 1 above, the Disclosing Party has found records of investments or profits from slavery or slaveholder insurance policies. The Disclosing Party verifies that the following constitutes full disclosure of all such records, including the names of any and all slaves or slaveholders described in those records:

SECTION VI -- CERTIFICATIONS FOR FEDERALLY FUNDED MATTERS

NOTE: If the Matter is federally funded, complete this Section VI. If the Matter is not federally funded, proceed to Section VII. For purposes of this Section VI, tax credits allocated by the City and proceeds of debt obligations of the City are not federal funding.

A. CERTIFICATION REGARDING LOBBYING

1. List below the names of all persons or entities registered under the federal Lobbying Disclosure Act of 1995 who have made lobbying contacts on behalf of the Disclosing Party with respect to the Matter: (Add sheets if necessary):

(If no explanation appears or begins on the lines above, or if the letters "NA" or if the word "None" appear, it will be conclusively presumed that the Disclosing Party means that NO persons or entities registered under the Lobbying Disclosure Act of 1995 have made lobbying contacts on behalf of the Disclosing Party with respect to the Matter.)

2. The Disclosing Party has not spent and will not expend any federally appropriated funds to pay any person or entity listed in Paragraph A.1. above for his or her lobbying activities or to pay any person or entity to influence or attempt to influence an officer or employee of any agency, as defined by applicable federal law, a member of Congress, an officer or employee of Congress, or an employee of a member of Congress, in connection with the award of any federally funded contract, making any federally funded grant or loan, entering into any cooperative agreement, or to extend, continue, renew, amend, or modify any federally funded contract, grant, loan, or cooperative agreement.

3. The Disclosing Party will submit an updated certification at the end of each calendar quarter in which there occurs any event that materially affects the accuracy of the statements and information set forth in paragraphs A.1. and A.2. above.

4. The Disclosing Party certifies that either: (i) it is not an organization described in section 501(c)(4) of the Internal Revenue Code of 1986; or (ii) it is an organization described in section 501(c)(4) of the Internal Revenue Code of 1986 but has not engaged and will not engage in "Lobbying Activities".

5. If the Disclosing Party is the Applicant, the Disclosing Party must obtain certifications equal in form and substance to paragraphs A.1. through A.4. above from all subcontractors before it awards any subcontract and the Disclosing Party must maintain all such subcontractors' certifications for the duration of the Matter and must make such certifications promptly available to the City upon request.

B. CERTIFICATION REGARDING EQUAL EMPLOYMENT OPPORTUNITY

If the Matter is federally funded, federal regulations require the Applicant and all proposed subcontractors to submit the following information with their bids or in writing at the outset of negotiations.

Is the Disclosing Party the Applicant?

Yes No

If "Yes," answer the three questions below:

1. Have you developed and do you have on file affirmative action programs pursuant to applicable federal regulations? (See 41 CFR Part 60-2.)

Yes No

2. Have you filed with the Joint Reporting Committee, the Director of the Office of Federal Contract Compliance Programs, or the Equal Employment Opportunity Commission all reports due under the applicable filing requirements?

Yes No

3. Have you participated in any previous contracts or subcontracts subject to the equal opportunity clause?

Yes No

If you checked "No" to question 1. or 2. above, please provide an explanation:

SECTION VII -- ACKNOWLEDGMENTS, CONTRACT INCORPORATION, COMPLIANCE, PENALTIES, DISCLOSURE

The Disclosing Party understands and agrees that:

A. The certifications, disclosures, and acknowledgments contained in this EDS will become part of any contract or other agreement between the Applicant and the City in connection with the Matter, whether procurement, City assistance, or other City action, and are material inducements to the City's execution of any contract or taking other action with respect to the Matter. The Disclosing Party understands that it must comply with all statutes, ordinances, and regulations on which this EDS is based.

B. The City's Governmental Ethics and Campaign Financing Ordinances, Chapters 2-156 and 2-164 of the Municipal Code, impose certain duties and obligations on persons or entities seeking City contracts, work, business, or transactions. The full text of these ordinances and a training program is available on line at www.cityofchicago.org/Ethics, and may also be obtained from the City's Board of Ethics, 740 N.

Sedgwick St., Suite 500, Chicago, IL 60610, (312) 744-9660. The Disclosing Party must comply fully with the applicable ordinances.

C. If the City determines that any information provided in this EDS is false, incomplete or inaccurate, any contract or other agreement in connection with which it is submitted may be rescinded or be void or voidable, and the City may pursue any remedies under the contract or agreement (if not rescinded or void), at law, or in equity, including terminating the Disclosing Party's participation in the Matter and/or declining to allow the Disclosing Party to participate in other transactions with the City. Remedies at law for a false statement of material fact may include incarceration and an award to the City of treble damages.

D. It is the City's policy to make this document available to the public on its Internet site and/or upon request. Some or all of the information provided on this EDS and any attachments to this EDS may be made available to the public on the Internet, in response to a Freedom of Information Act request, or otherwise. By completing and signing this EDS, the Disclosing Party waives and releases any possible rights or claims which it may have against the City in connection with the public release of information contained in this EDS and also authorizes the City to verify the accuracy of any information submitted in this EDS.

E. The information provided in this EDS must be kept current. In the event of changes, the Disclosing Party must supplement this EDS up to the time the City takes action on the Matter. If the Matter is a contract being handled by the City's Department of Procurement Services, the Disclosing Party must update this EDS as the contract requires. **NOTE:** With respect to Matters subject to Article I of Chapter 1-23 of the Municipal Code (imposing **PERMANENT INELIGIBILITY** for certain specified offenses), the information provided herein regarding eligibility must be kept current for a longer period, as required by Chapter 1-23 and Section 2-154-020 of the Municipal Code.

The Disclosing Party represents and warrants that:

F.1. The Disclosing Party is not delinquent in the payment of any tax administered by the Illinois Department of Revenue, nor are the Disclosing Party or its Affiliated Entities delinquent in paying any fine, fee, tax or other charge owed to the City. This includes, but is not limited to, all water charges, sewer charges, license fees, parking tickets, property taxes or sales taxes.

F.2 If the Disclosing Party is the Applicant, the Disclosing Party and its Affiliated Entities will not use, nor permit their subcontractors to use, any facility listed by the U.S. E.P.A. on the federal Excluded Parties List System ("EPLS") maintained by the U. S. General Services Administration.

F.3 If the Disclosing Party is the Applicant, the Disclosing Party will obtain from any contractors/subcontractors hired or to be hired in connection with the Matter certifications equal in form and substance to those in F.1. and F.2. above and will not, without the prior written consent of the City, use any such contractor/subcontractor that does not provide such certifications or that the Disclosing Party has reason to believe has not provided or cannot provide truthful certifications.

NOTE: If the Disclosing Party cannot certify as to any of the items in F.1., F.2. or F.3. above, an explanatory statement must be attached to this EDS.

CERTIFICATION

Under penalty of perjury, the person signing below: (1) warrants that he/she is authorized to execute this EDS and Appendix A (if applicable) on behalf of the Disclosing Party, and (2) warrants that all certifications and statements contained in this EDS and Appendix A (if applicable) are true, accurate and complete as of the date furnished to the City.

Daughters of Charity, Inc.
(Print or type name of Disclosing Party)

By: Thomas M Beck
(Sign here)

Thomas M. Beck
(Print or type name of person signing)

CFO
(Print or type title of person signing)

Signed and sworn to before me on (date) 12/21/2012,
at St. Louis County, MO (state).

J. Rachford Notary Public.

Commission expires: Jan. 14, 2013.



**CITY OF CHICAGO
ECONOMIC DISCLOSURE STATEMENT AND AFFIDAVIT
APPENDIX A**

FAMILIAL RELATIONSHIPS WITH ELECTED CITY OFFICIALS AND DEPARTMENT HEADS

This Appendix is to be completed only by (a) the Applicant, and (b) any legal entity which has a direct ownership interest in the Applicant exceeding 7.5 percent. It is not to be completed by any legal entity which has only an indirect ownership interest in the Applicant.

Under Municipal Code Section 2-154-015, the Disclosing Party must disclose whether such Disclosing Party or any "Applicable Party" or any Spouse or Domestic Partner thereof currently has a "familial relationship" with any elected city official or department head. A "familial relationship" exists if, as of the date this EDS is signed, the Disclosing Party or any "Applicable Party" or any Spouse or Domestic Partner thereof is related to the mayor, any alderman, the city clerk, the city treasurer or any city department head as spouse or domestic partner or as any of the following, whether by blood or adoption: parent, child, brother or sister, aunt or uncle, niece or nephew, grandparent, grandchild, father-in-law, mother-in-law, son-in-law, daughter-in-law, stepfather or stepmother, stepson or stepdaughter, stepbrother or stepsister or half-brother or half-sister.

"Applicable Party" means (1) all executive officers of the Disclosing Party listed in Section II.B.1.a., if the Disclosing Party is a corporation; all partners of the Disclosing Party, if the Disclosing Party is a general partnership; all general partners and limited partners of the Disclosing Party, if the Disclosing Party is a limited partnership; all managers, managing members and members of the Disclosing Party, if the Disclosing Party is a limited liability company; (2) all principal officers of the Disclosing Party; and (3) any person having more than a 7.5 percent ownership interest in the Disclosing Party. "Principal officers" means the president, chief operating officer, executive director, chief financial officer, treasurer or secretary of a legal entity or any person exercising similar authority.

Does the Disclosing Party or any "Applicable Party" or any Spouse or Domestic Partner thereof currently have a "familial relationship" with an elected city official or department head?

Yes

No

If yes, please identify below (1) the name and title of such person, (2) the name of the legal entity to which such person is connected; (3) the name and title of the elected city official or department head to whom such person has a familial relationship, and (4) the precise nature of such familial relationship.

Attachment

City of Chicago
Economic Disclosure Statement and Affidavit

Daughters of Charity, Inc.
4330 Olive Street
St. Louis, Missouri 63108

SECTION II.B. – Names and titles of all executive officers and all directors of the Daughters of Charity, Inc.

Name	Title
Sister Louise Gallahue	President / Chair / Director
Sister Mary Walz	Vice Chair / Director
Sister Jane Graves	Secretary / Treasurer / Director
Sister Rose Ann Aguilar	Director
Sister Nora Gatto	Director
Sister Janet Keim	Director
Sister Mary Beth Kubera	Director
Sister Jean Rhoads	Director
Sister Joanne Vasa	Director
Sister Mary Catherine Warehime	Director
Sister Maureen Schmalzried	Assistant Secretary
Thomas M. Beck	Chief Financial Officer

January 10, 2013

USPS First Class Mail

Re: 2847 West Jackson Blvd.
Chicago, Illinois

Dear Property Owner or Resident:

In accordance with the requirements for an Amendment to the Chicago Zoning Ordinance, please be informed that on or about January 10, 2013, I, the undersigned attorney, will file an application for a change in zoning from the RT-4 Residential Two-Flat, Townhouse and Multi-Unit District to that of the B3-3 Community Shopping District on behalf of the Applicant for the property located at 2847 W. Jackson Blvd., Chicago Illinois and bounded by West Jackson Blvd.; a line 143.56 feet East of and parallel to North Francisco Avenue; the alley next South of and parallel to West Jackson Blvd.; and a line 118.56 feet East of and parallel to North Francisco Avenue.

The purpose of the proposed amendment is to add the property to a larger development site with the zoning designation of B3-3 in order to rehabilitate an existing 23,809 sq. ft. building and to add on a 3,514 sq. ft. addition for a new community center containing a total of 27,323 sq. ft.

The Applicant is Marillac Social Center, 212 S Francisco Ave., Chicago, IL 60612 and the owner of the property is Daughters of Charity Ministries, Inc., 4330 Olive Street, St. Louis, MO 63108.

I am the attorney for the Applicant. My address is 130 E. Randolph Street, Suite 3800, Chicago, Illinois 60601.

Please note that the Applicant is not seeking to purchase or rezone your property. The Applicant is required by law to send you this notice because you own property located within 250 feet of the proposed development.

Very Truly Yours,



John J. George

January 10, 2013

Chairman, Committee on Zoning
City Hall – Room 304
121 N. LaSalle St.
Chicago, Illinois 60602

Re: Zoning Amendment Application
2847 West Jackson Blvd.
Chicago, Illinois

The undersigned, Chris A. Leach, being first duly sworn, states as follows:

The undersigned certifies that he has complied with the requirements of § 17-13-0107 of the Chicago Zoning Ordinance by sending the attached letter by USPS first class mail to property owners of the subject property and to property owners of all property within 250 feet of the property lines of the subject property, excluding public roads, streets, alleys, and other public ways, up to a maximum of 400 feet including public ways.

The undersigned certifies that the notice contained: the common street address and boundaries of the subject property; a description of the nature, scope and purpose of the application; the name and address of the applicant; the date that the applicant intends to file the application; and a source for additional information on the application and a statement that the applicant intends to file the application for a change in zoning on approximately January 10, 2013.

The undersigned certifies that he has made a *bona fide* effort to determine the names and last known addresses of the persons to be provided with notice by obtaining ownership information from the most recent authentic tax records of Cook County.

The undersigned certifies that the accompanying list is a complete list containing the names and last known addresses of the persons provided with notice.

The undersigned certifies compliance with all applicable written notice requirements.

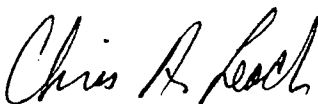

Chris A. Leach

Subscribed and sworn to
before me this January 10, 2013.

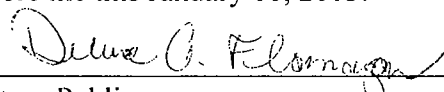

Notary Public

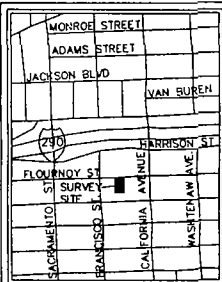

VICINITY MAP - NOT TO SCALE

GREMLEY & BIEDERMANN

A DIVISION OF
PLCS Corporation

LICENSE NO. 181-003322

PROFESSIONAL LAND SURVEYORS

4505 NORTH ELSTON AVENUE, CHICAGO, IL 60630

TELEPHONE: (773) 685-5102 FAX: (773) 286-4184 EMAIL: INFO@PLCS-SURVEY.COM

ALTA/ACSM Land Title Survey

LOT 6 IN JAS. COUCH'S SUBDIVISION OF THE NORTH HALF OF SOUTH HALF OF NORTHWEST QUATER OF SECTION 13, TOWNSHIP 39 NORTH, RANGE 13 EAST OF THE THIRD PRINCIPAL MERIDIAN IN COOK COUNTY, ILLINOIS.

AREA OF PROPERTY = 3,126 SQ. FT. OR 0.07 ACRES

W. JACKSON BOULEVARD (RECORD 80 FT PUBLIC R.O.W.)

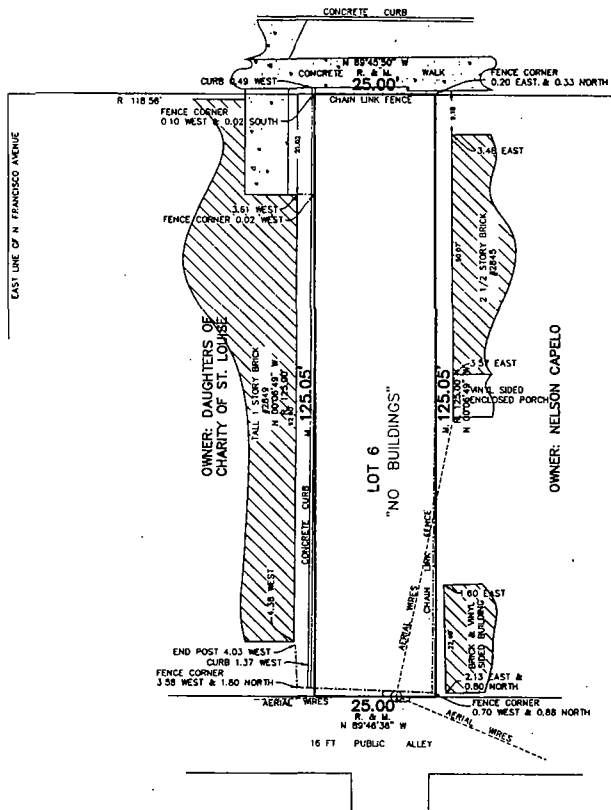

Legend:

- Storm MH
- Storm CB
- Storm Inlet
- Storm Inlet
- Storm MH
- San Storm Combo MH
- San Clean Out
- Water Valve Vault
- Water MH
- Water Buffalo Box
- Water Hand Hole
- Water Meter
- Water Fire Hydrant
- Telephone MH
- Telephone Vault
- Telephone Pedestal
- Public Telephone
- Communication Pedestal
- Utility Pole
- Guy Anchor
- Electric Manhole
- Electric MH
- Electric Vault
- Electric Hand Hole
- Electric Pad
- Electric Meter
- Electric Pedestal
- Electric Light Pole
- Electric Traffic Signal
- Electric Light Pole with Traffic Signal
- Electric Traffic Control Box
- Electric Traffic Vault
- Electric Ground Light
- Electric Mounted Wall Light
- Gas Buffalo Box
- Gas Hand Hole
- Gas Meter
- Gas Valve
- Gas MH
- Gas Vault
- Cable TV Pedestal
- Tree - Deciduous
- Tree - Evergreen
- Parking Meter
- Parking Pay Box
- Sign Post
- Mail Box
- Bumper Post
- Drive Rock
- Soil Boring
- Uncovered Manhole
- Auto Sprinkler
- House Connection
- Fire Alarm
- Flag Pole

GRAPHIC SCALE



To: Daughters of Charity of St. Louise, Marillac Center, and First American Title Insurance Company.

This is to certify that this map or plat and the survey on which it is based were made in accordance with the 2011 Minimum Standard Detail Requirements for ALTA/ACSM Land Title Surveys, jointly established and adopted by ALTA and NSPS, and include items 2, 3, 4, 8, 9, and 11(a) of Table A thereof.

The field work was completed on April 16, 2012.

Date of Plat April 20, 2012

By:

Robert G. Biedermann

Robert G. Biedermann
Professional Illinois Land Surveyor No. 2802



SURVEY NOTES

The survey was prepared without the benefit of, and is subject to, all restrictions and matters appearing of record as might be disclosed by a current title commitment.

Surveyor's license expires November 30, 2012.

Note R & M denotes Record and M easured distances respectively.

Distances are marked in feet and decimal parts thereof. Complete all poles BEFORE building by same and at once report any differences BEFORE changes in stone.

For easements, building lines and other restrictions not shown on survey plat, refer to your abstract, deed, contract, title policy and local building line regulations.

NO dimensions shall be assumed by scale measurement upon this plat.

Monumentation at witness points were not set at the client's request.

Unless otherwise noted herein the Bearing, Elevation Datum and Coordinate Datum if used is ASSUMED.

COPYRIGHT GREMLEY & BIEDERMANN, INC 2012 "All Rights Reserved"

ORDERED BY: MHP/LAC SOCIAL CENTER	CHECKED: DRAWING
ADDRESS: 2817 W JACKSON STREET	BY: [Signature]
GREMLEY & BIEDERMANN	
PLCS CORPORATION	
LICENSE NO. 181-003322	
4505 NORTH ELSTON AVENUE, CHICAGO, IL 60630	
TELEPHONE: (773) 685-5102 FAX: (773) 286-4184 EMAIL: INFO@PLCS-SURVEY.COM	

ORDER NO.	DATE	PAGE NO.
2012-16292-001	APRIL 16, 2012	1 OF 1
SCALE		
1" = 15 FEET		

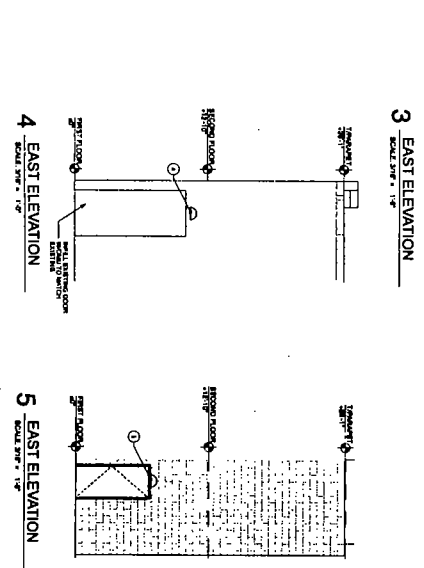
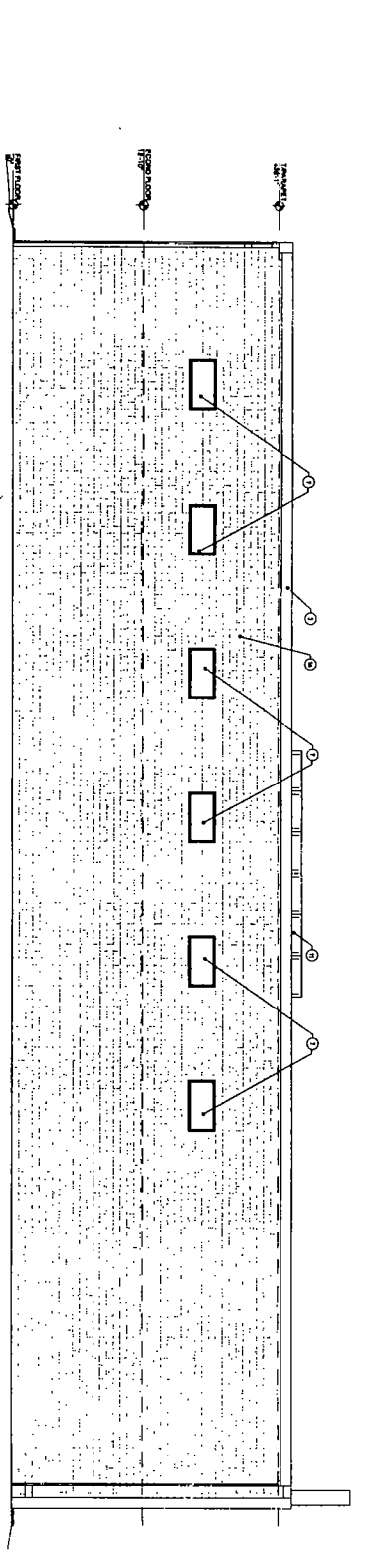
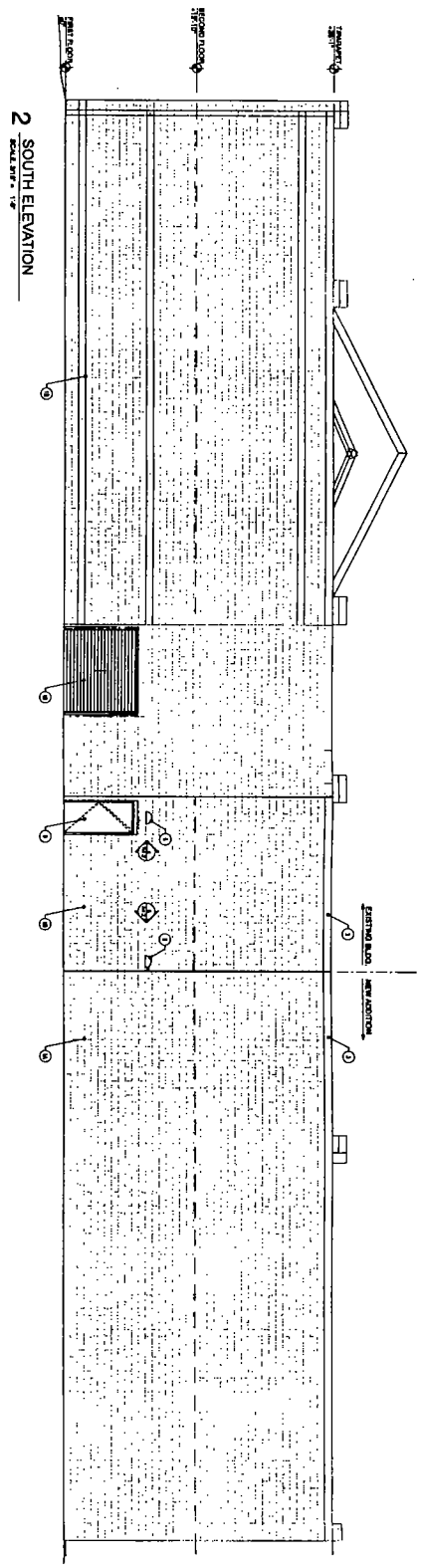

ELEVATION MATERIALS

1. NEW 7/8\"/>	1. NEW STITCHED MESH WALL MOUNTED LIGHT FIXTURE COLLECTION
2. NEW 1\"/>	2. NEW WINDOW UNIT AS PER MANUFACTURER'S SPECIFICATIONS
3. NEW 1\"/>	3. NEW WINDOW UNIT AS PER MANUFACTURER'S SPECIFICATIONS
4. NEW 1\"/>	4. NEW WINDOW UNIT AS PER MANUFACTURER'S SPECIFICATIONS
5. NEW 1\"/>	5. NEW WINDOW UNIT AS PER MANUFACTURER'S SPECIFICATIONS
6. NEW 1\"/>	6. NEW WINDOW UNIT AS PER MANUFACTURER'S SPECIFICATIONS
7. NEW 1\"/>	7. NEW WINDOW UNIT AS PER MANUFACTURER'S SPECIFICATIONS
8. NEW 1\"/>	8. NEW WINDOW UNIT AS PER MANUFACTURER'S SPECIFICATIONS
9. NEW 1\"/>	9. NEW WINDOW UNIT AS PER MANUFACTURER'S SPECIFICATIONS
10. NEW 1\"/>	10. NEW WINDOW UNIT AS PER MANUFACTURER'S SPECIFICATIONS

MARILLAC COMMUNITY CENTER
2620 W. Addison Blvd
Chicago, IL 60612

NOTES:

NOT FOR CONSTRUCTION

A4.2

11/05/15

A4.2

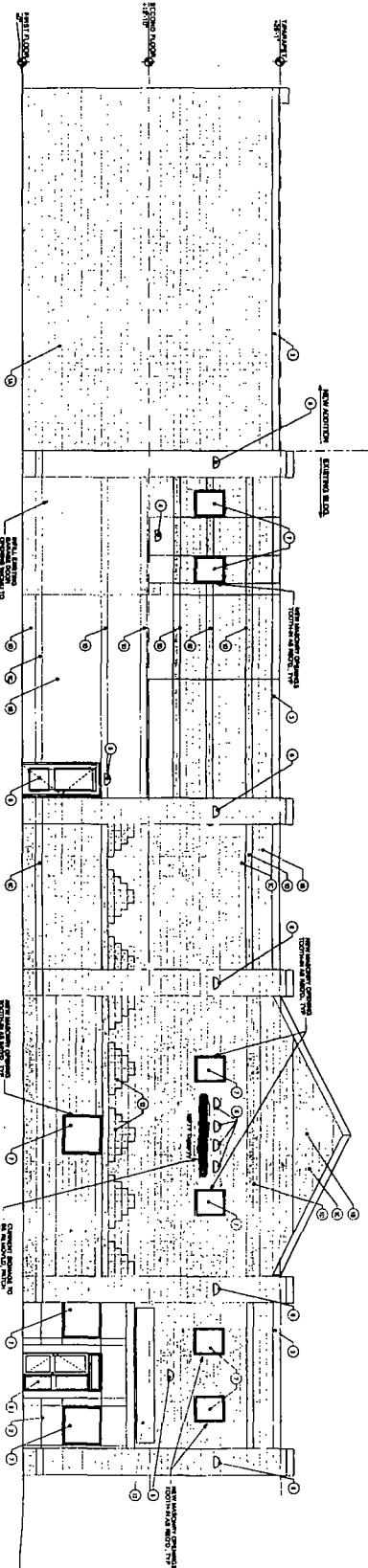

2 NORTH ELEVATION
SCALE 1/4" = 1'-0"

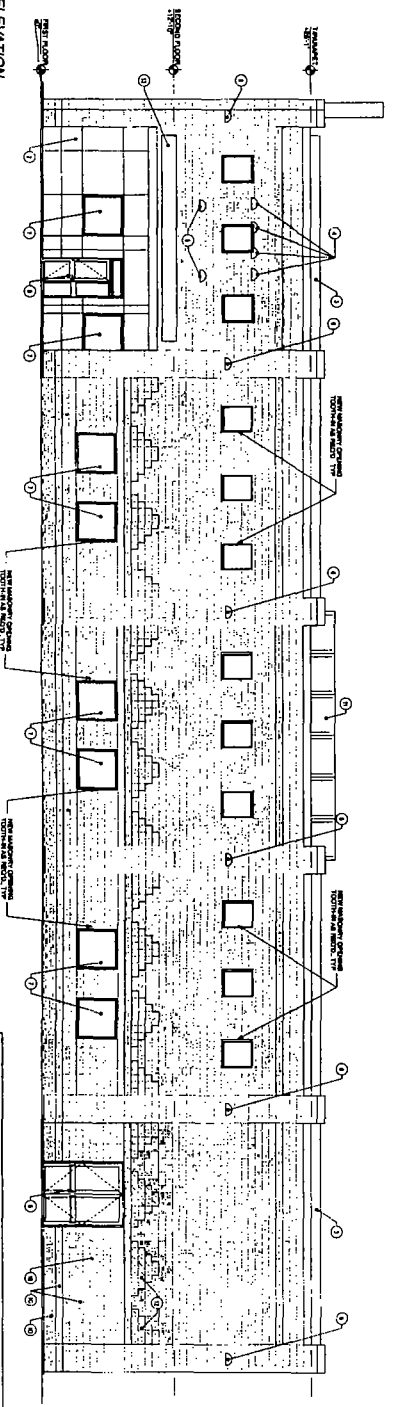

3 WEST ELEVATION
SCALE 1/4" = 1'-0"

ELEVATION MATERIALS

1. NEW 7 1/2" x 14" x 18" SP. 2. CONCRETE FACE
2. NEW 7 1/2" x 14" x 18" SP. 2. CONCRETE FACE
3. NEW 7 1/2" x 14" x 18" SP. 2. CONCRETE FACE
4. NEW 7 1/2" x 14" x 18" SP. 2. CONCRETE FACE
5. NEW 7 1/2" x 14" x 18" SP. 2. CONCRETE FACE
6. NEW 7 1/2" x 14" x 18" SP. 2. CONCRETE FACE
7. NEW 7 1/2" x 14" x 18" SP. 2. CONCRETE FACE
8. NEW 7 1/2" x 14" x 18" SP. 2. CONCRETE FACE
9. NEW 7 1/2" x 14" x 18" SP. 2. CONCRETE FACE
10. NEW 7 1/2" x 14" x 18" SP. 2. CONCRETE FACE
11. NEW 7 1/2" x 14" x 18" SP. 2. CONCRETE FACE
12. NEW 7 1/2" x 14" x 18" SP. 2. CONCRETE FACE
13. NEW 7 1/2" x 14" x 18" SP. 2. CONCRETE FACE
14. NEW 7 1/2" x 14" x 18" SP. 2. CONCRETE FACE
15. NEW 7 1/2" x 14" x 18" SP. 2. CONCRETE FACE
16. NEW 7 1/2" x 14" x 18" SP. 2. CONCRETE FACE
17. NEW 7 1/2" x 14" x 18" SP. 2. CONCRETE FACE
18. NEW 7 1/2" x 14" x 18" SP. 2. CONCRETE FACE
19. NEW 7 1/2" x 14" x 18" SP. 2. CONCRETE FACE
20. NEW 7 1/2" x 14" x 18" SP. 2. CONCRETE FACE

NOT FOR CONSTRUCTION

COMPILED BY: J. B. B. 11/8/35

DATE: 11/8/35

BY: J. B. B.

SCALE: A4.1

NO. 11835

DATE: 11/8/35

BY: J. B. B.

MARILLAC COMMUNITY CENTER

2455 W. JACKSON BLVD
CHICAGO, IL 60612

MR. J. B. B. ARCHITECTS, P.C.
211 North Dearborn Street, Suite 100
Chicago, IL 60614
Tel: 312.467.1111

NOTES

A SECOND FLOOR PLAN - PROPOSED
SCALE: 1/8" = 1'-0"

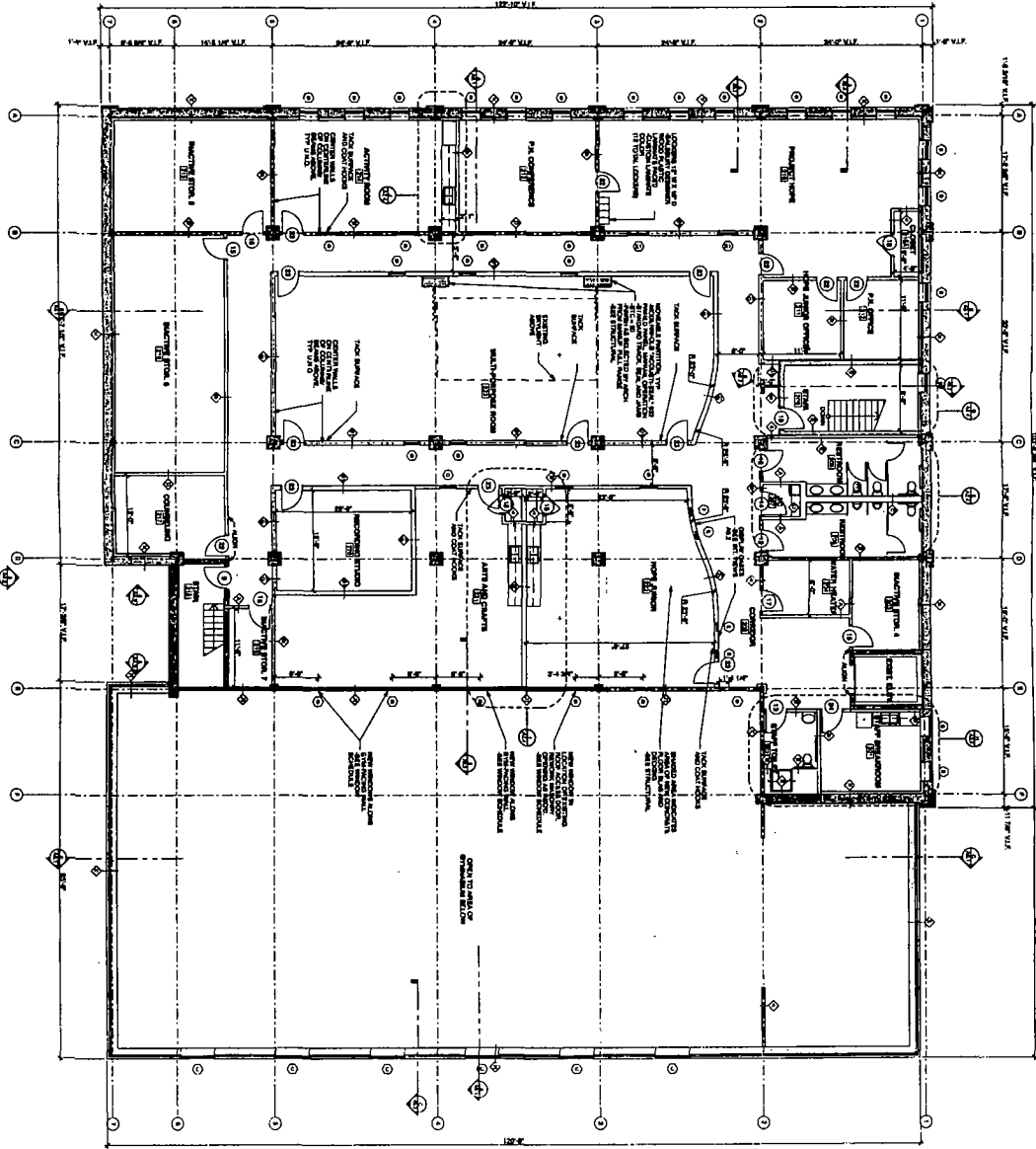

MARILLAC COMMUNITY CENTER
2659 W Jackson Blvd
Chicago, IL 60612
BORGHESE ARCHITECTS P.C.
177 West Madison Street, Suite 2000
Chicago, IL 60602

NOTES

NOT FOR CONSTRUCTION

NO.	REVISION	DATE	BY

3030 N. LAUREL AVENUE, SUITE 100
CHICAGO, IL 60641
TEL: (773) 525-1234
FAX: (773) 525-1235

DRAWING NO. 11.23.01
SHEET NUMBER
11635
DATE: 11/03/05
BY: JAV
CHECKED BY: HD

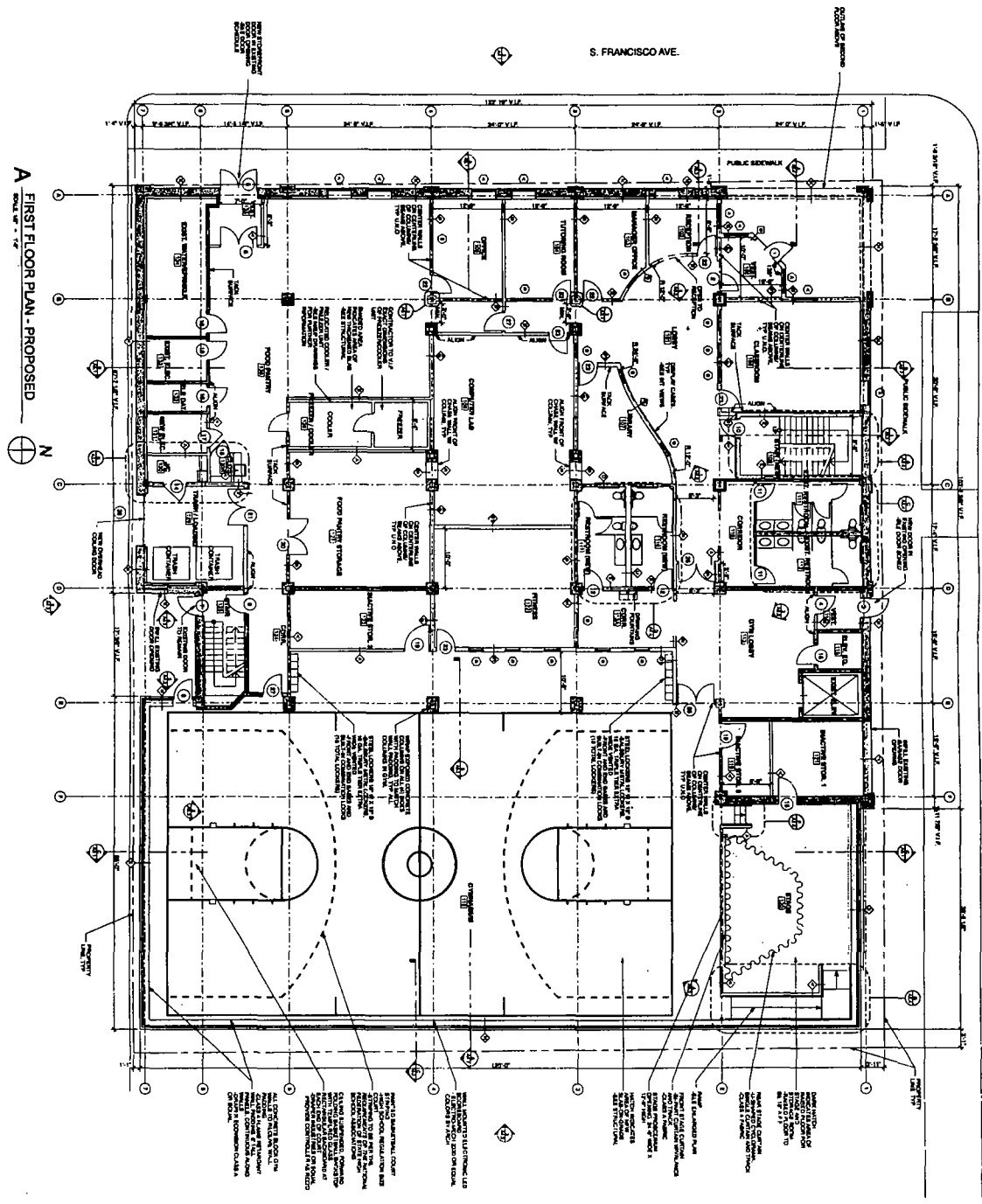

MARILLAC COMMUNITY CENTER
2350 W. Jackson Blvd
Chicago, IL 60612

BOB ALBERT ARCHITECTS, P.C.
1100 North Dearborn Street, Chicago, Illinois 60610
Tel: 312.467.1100 Fax: 312.467.1101

NOTES:
1. THIS DRAWING IS THE PROPERTY OF BOB ALBERT ARCHITECTS, P.C. AND IS NOT TO BE REPRODUCED OR TRANSMITTED IN ANY FORM OR BY ANY MEANS, ELECTRONIC OR MECHANICAL, INCLUDING PHOTOCOPYING, RECORDING, OR BY ANY INFORMATION STORAGE AND RETRIEVAL SYSTEM, WITHOUT THE WRITTEN PERMISSION OF BOB ALBERT ARCHITECTS, P.C.

NO.	DESCRIPTION	DATE
1	PRELIMINARY	10/12/01
2	REVISED	11/15/01
3	REVISED	12/10/01
4	REVISED	01/10/02
5	REVISED	02/10/02
6	REVISED	03/10/02
7	REVISED	04/10/02
8	REVISED	05/10/02
9	REVISED	06/10/02
10	REVISED	07/10/02
11	REVISED	08/10/02
12	REVISED	09/10/02
13	REVISED	10/10/02
14	REVISED	11/10/02
15	REVISED	12/10/02
16	REVISED	01/10/03
17	REVISED	02/10/03
18	REVISED	03/10/03
19	REVISED	04/10/03
20	REVISED	05/10/03
21	REVISED	06/10/03
22	REVISED	07/10/03
23	REVISED	08/10/03
24	REVISED	09/10/03
25	REVISED	10/10/03
26	REVISED	11/10/03
27	REVISED	12/10/03
28	REVISED	01/10/04
29	REVISED	02/10/04
30	REVISED	03/10/04
31	REVISED	04/10/04
32	REVISED	05/10/04
33	REVISED	06/10/04
34	REVISED	07/10/04
35	REVISED	08/10/04
36	REVISED	09/10/04
37	REVISED	10/10/04
38	REVISED	11/10/04
39	REVISED	12/10/04
40	REVISED	01/10/05
41	REVISED	02/10/05
42	REVISED	03/10/05
43	REVISED	04/10/05
44	REVISED	05/10/05
45	REVISED	06/10/05
46	REVISED	07/10/05
47	REVISED	08/10/05
48	REVISED	09/10/05
49	REVISED	10/10/05
50	REVISED	11/10/05
51	REVISED	12/10/05
52	REVISED	01/10/06
53	REVISED	02/10/06
54	REVISED	03/10/06
55	REVISED	04/10/06
56	REVISED	05/10/06
57	REVISED	06/10/06
58	REVISED	07/10/06
59	REVISED	08/10/06
60	REVISED	09/10/06
61	REVISED	10/10/06
62	REVISED	11/10/06
63	REVISED	12/10/06
64	REVISED	01/10/07
65	REVISED	02/10/07
66	REVISED	03/10/07
67	REVISED	04/10/07
68	REVISED	05/10/07
69	REVISED	06/10/07
70	REVISED	07/10/07
71	REVISED	08/10/07
72	REVISED	09/10/07
73	REVISED	10/10/07
74	REVISED	11/10/07
75	REVISED	12/10/07
76	REVISED	01/10/08
77	REVISED	02/10/08
78	REVISED	03/10/08
79	REVISED	04/10/08
80	REVISED	05/10/08
81	REVISED	06/10/08
82	REVISED	07/10/08
83	REVISED	08/10/08
84	REVISED	09/10/08
85	REVISED	10/10/08
86	REVISED	11/10/08
87	REVISED	12/10/08
88	REVISED	01/10/09
89	REVISED	02/10/09
90	REVISED	03/10/09
91	REVISED	04/10/09
92	REVISED	05/10/09
93	REVISED	06/10/09
94	REVISED	07/10/09
95	REVISED	08/10/09
96	REVISED	09/10/09
97	REVISED	10/10/09
98	REVISED	11/10/09
99	REVISED	12/10/09
100	REVISED	01/10/10

NOT FOR CONSTRUCTION

10/10/05

BOB ALBERT ARCHITECTS, P.C.

1100 North Dearborn Street, Chicago, Illinois 60610

Tel: 312.467.1100 Fax: 312.467.1101

OWNER: MARILLAC COMMUNITY CENTER PROJECT NO.: 11635 DATE: 10/10/05	SHEET NUMBER: A2.1 OF 10
--	---------------------------------------

