



Office of the Chicago City
Clerk



Or2011-832

Office of the City Clerk

City Council Document Tracking Sheet

Meeting Date:	9/8/2011
Sponsor(s):	Ervin, Jason C. (28)
Type:	Order
Title:	Issuance of Sign(s)/Signboard(s) at 3146 W Madison St
Committee(s) Assignment:	Committee on Zoning, Landmarks and Building Standards

Committee on Buildings

(signs)

ORDERED, That the Commissioner of Buildings is hereby directed to issue a sign permit to: (Contractor's name and address)

Sure Light Sign Company
1225 Bowes Road
Elgin IL 60123

for the erection of a sign/signboard over 24 feet in height and/or over 100 square feet (in area of one face) at: (Business NAME & ADDRESS)

CVS/pharmacy
3146 W. Madison St.
Chicago IL 60612

Dimensions: length 15'8" height 20'

height above grade/roof to top of sign 20'

TOTAL SQUARE FOOT AREA 313

Such sign(s) shall comply with all applicable provisions of TITLE 17 of the Chicago Zoning Ordinance and all other applicable provisions of the Municipal Code of the City of Chicago governing the construction and maintenance of outdoor signs, signboards and structures.

Alderman, Ward 28
Jason Ervin

Permit Package

1/14/11

CVS pharmacy

CVS CS 44830 Store 75487
NEC Madison & Kedzie
Chicago, IL

Prepared for CVS By:



1225 Bowes Road, Elgin, IL 60123-5542
Phone: 847.214.9595 ~ Fax: 847.214.9596
www.surelightsign.com

B

28'-0"

42"

CVS/pharmacy

99 sq.ft.
Qty. 2

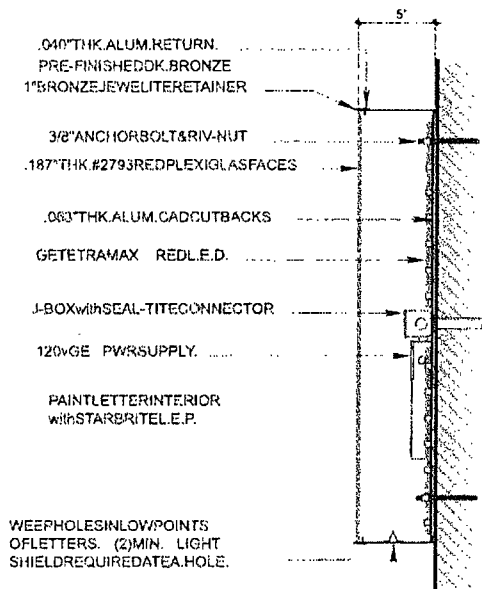

L.E.D. LETTER SECTION

N.T.S.



1225 Bowes Road, Elgin, IL 60123-5542
Phone: 847.214.9595 - Fax: 847.214.9596
www.surelightsign.com

CVS CS 44830 Store 75487
NEC Madison & Kedzie
Chicago, IL

Date: 1/14/11

Revisions:

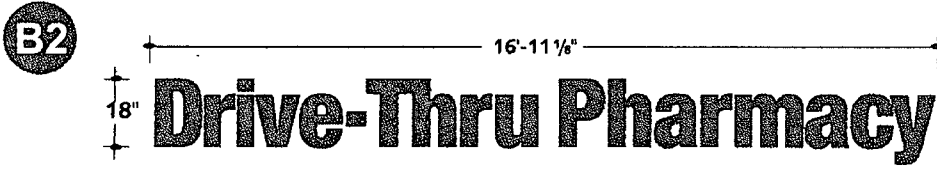

25.25 sq.ft.
Qty. 2

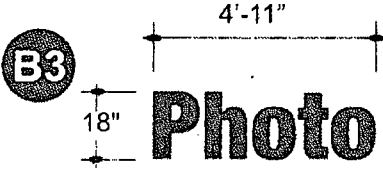

7.38 sq.ft.
Qty. 1

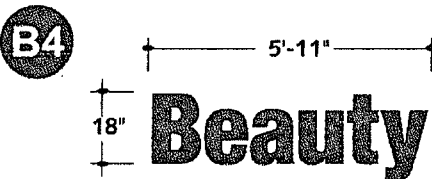

8.875 sq.ft.
Qty. 1

ILLUMINATED ANCILLARY BUILDING MESSAGES

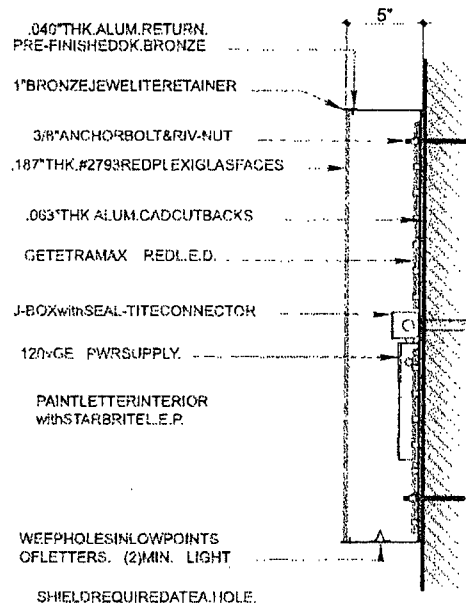

L.E.D. LETTERSECTION

N.T.S.



1225 Bowes Road, Elgin, IL 60123-5542
 Phone: 847.214.9595 - Fax: 847.214.9596
 www.surelightsign.com

CVS CS 44830 Store 75487
NEC Madison & Kedzie
Chicago, IL

Date: 1/14/11

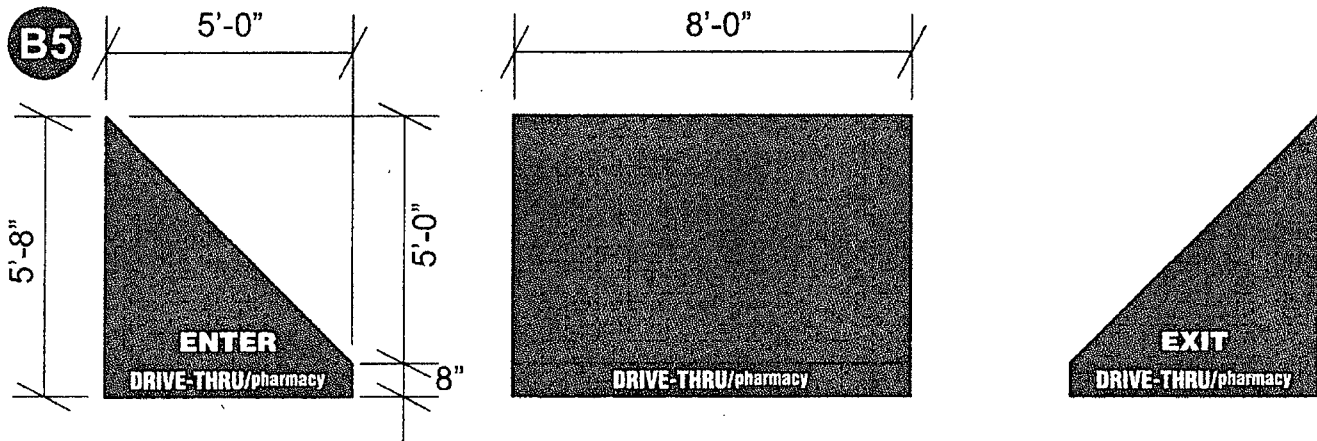

Revisions:

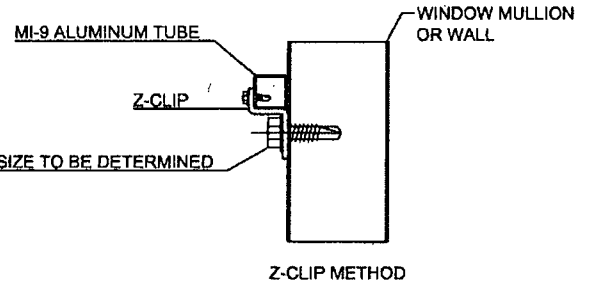
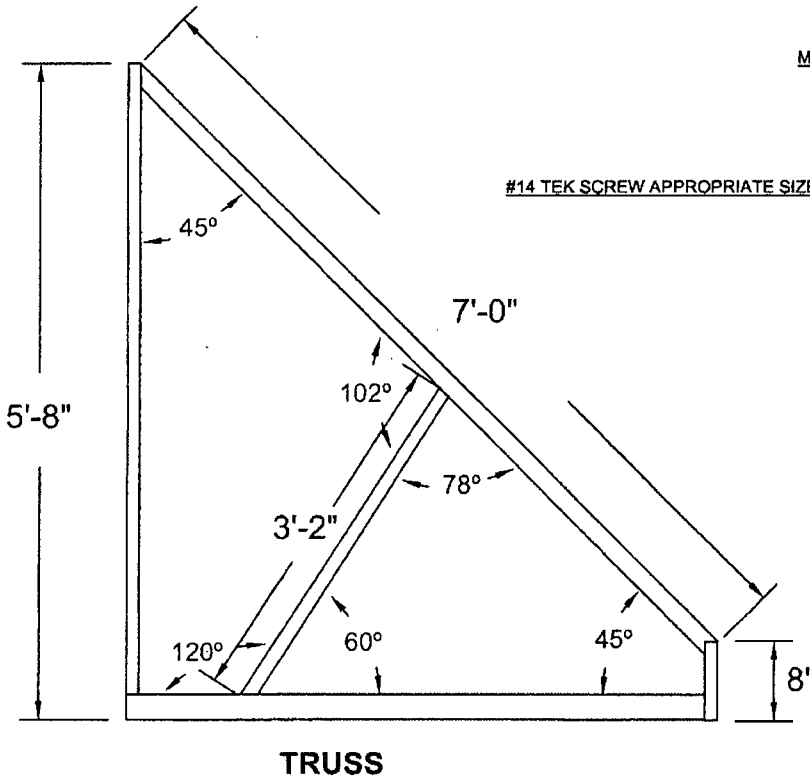

Drive-Thru Awning Qty. 1 - 5.07 sq. ft.

- One Shed Style Awning w/ Closed Ends
- All Aluminum Mill Finish Frame
- Red Weathertyte w/ Heat Transferred Graphics
- Non-Illuminated
- Z-Clips Provided For Installation



- 3/4" SQ 
- MI-09 
- MP-3 



1225 Bowes Road, Elgin, IL 60123-5542
 Phone: 847.214.9595 ~ Fax: 847.214.9596
 www.surelightsign.com

CVS CS 44830 Store 75487
NEC Madison & Kedzie
Chicago, IL

Date: 1/14/11
 Revisions: 3/24/11

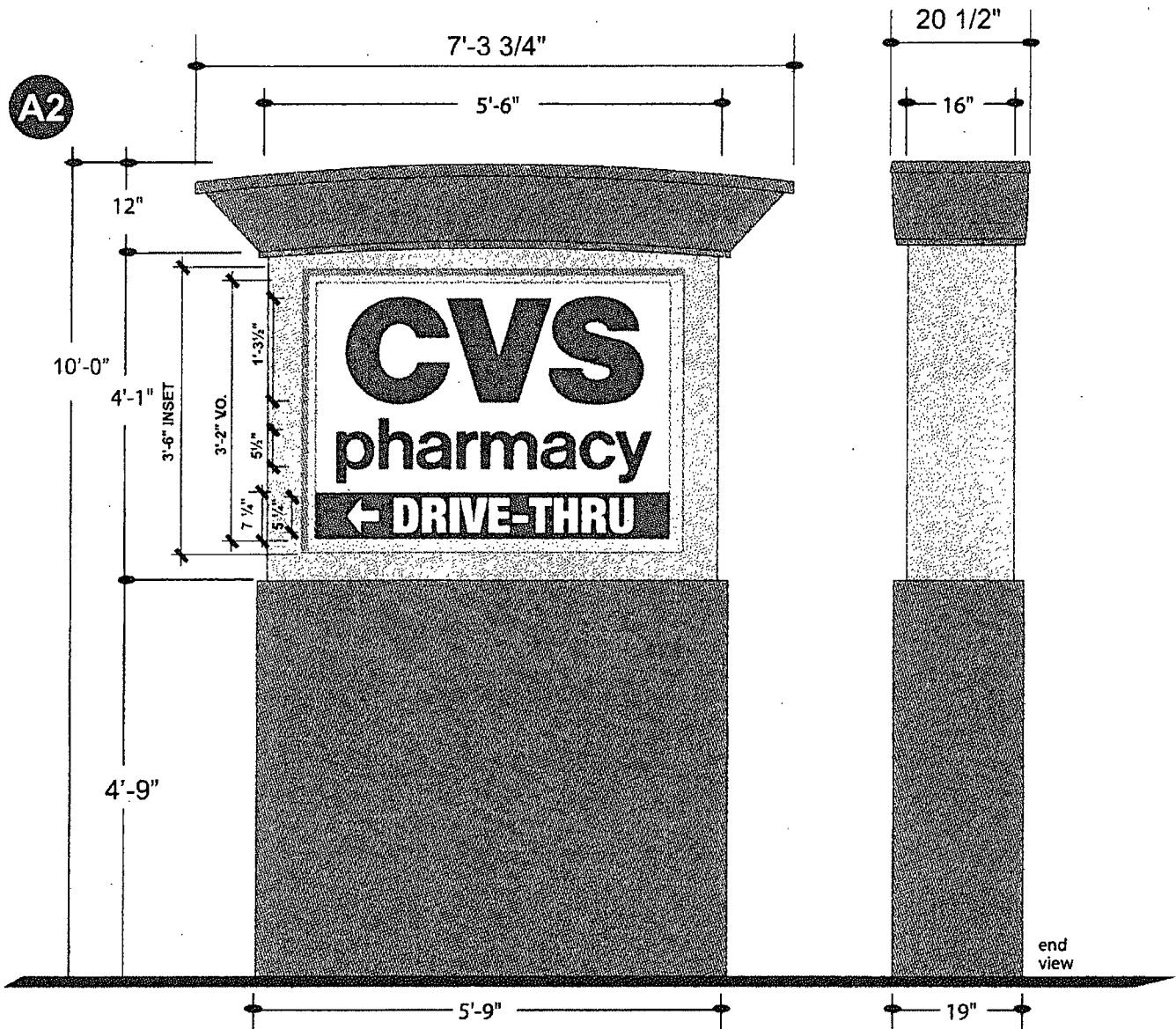

Double Face Internally Illuminated Monument Sign

- 3/16" white Lexan faces
- 230-53 red vinyl copy with 230-22 black outline
- 230-53 Red Vinyl Overlay W/white Sho Thru Copy
- Aluminum cabinet with mitred corners painted to match STO NA 04-0020 Medium Yellow Benjamin Moore #2154-50 Straw
- 3" aluminum retainers painted to match Colonial White
- Molded foam top cap painted to match STO NA 05-0001 Rafter Tail or Benjamin Moore #HC-47, "Brookline Beige"
- .090 aluminum base painted to match STO NA 05-0001 Rafter Tail or Benjamin Moore #HC-47, "Brookline Beige"



1225 Bowes Road, Elgin, IL 60123-5542
 Phone: 847.214.9595 ~ Fax: 847.214.9596
 www.surelightsign.com

CVS CS 44830 Store 75487
NEC Madison & Kedzie
Chicago, IL

Date: 1/14/11

Revisions:

Directional Signs

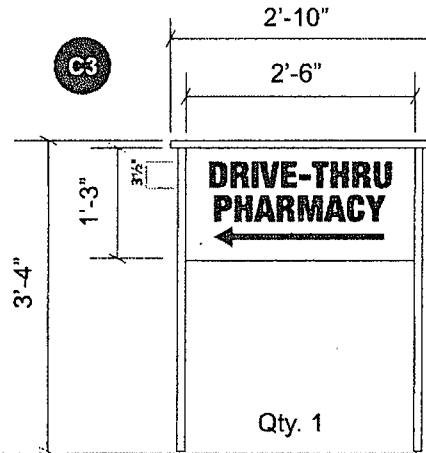

Construction Detail

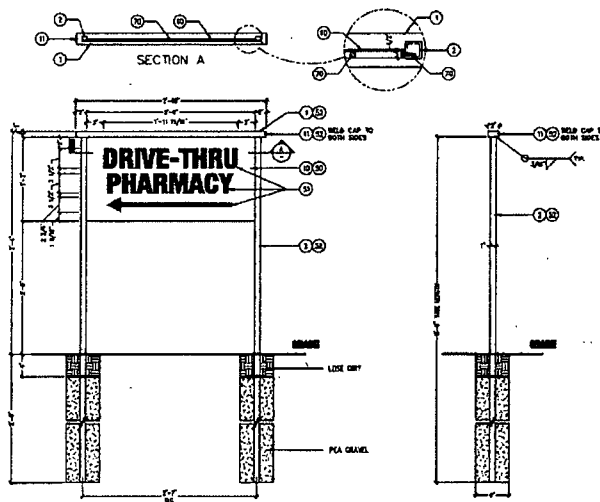

1225 Bowers Road, Elgin, IL 60123-5542
 Phone: 847.214.9595 - Fax: 847.214.9596
 www.surelightsign.com

CVS CS 44830 Store 75487
NEC Madison & Kedzie
Chicago, IL

Date: 1/14/11

Revisions:

Window and Door Signs

Receiving Door Sign

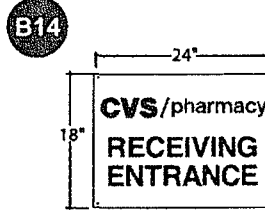

Qty 1

Drive Thru Signs

B9

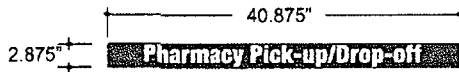

Qty 1

Temporary Signs

S1

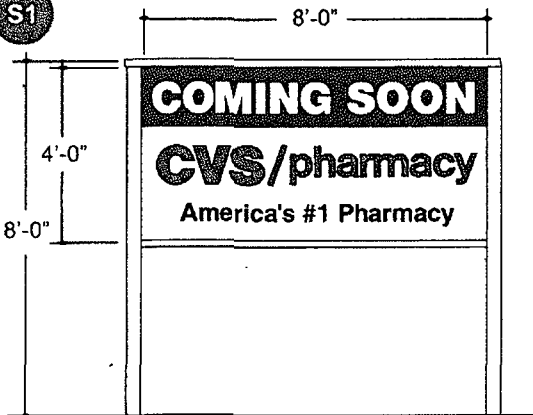

Qty. 2



1225 Bowes Road, Elgin, IL 60123-5542
Phone: 847.214.9595 -- Fax: 847.214.9596
www.surelightsign.com

CVS CS 44830 Store 75487
NEC Madison & Kedzie
Chicago, IL

Date: 1/14/11

Revisions:

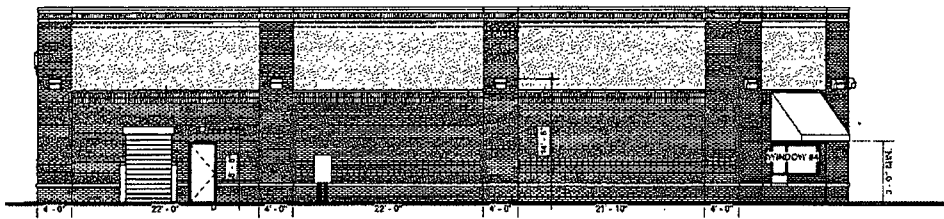
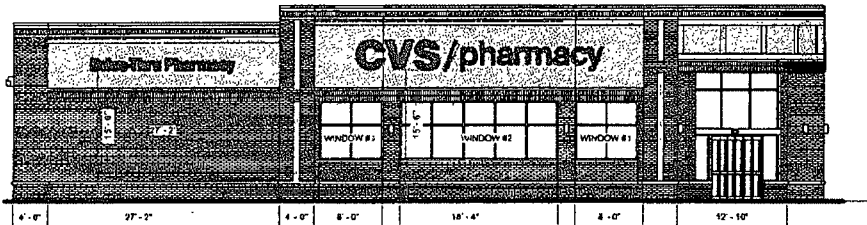
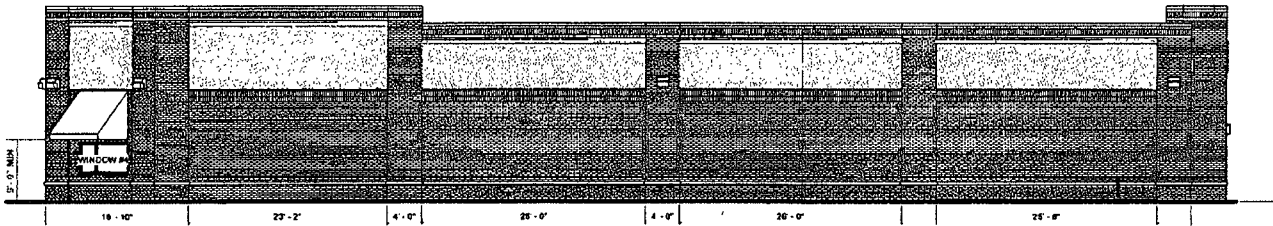
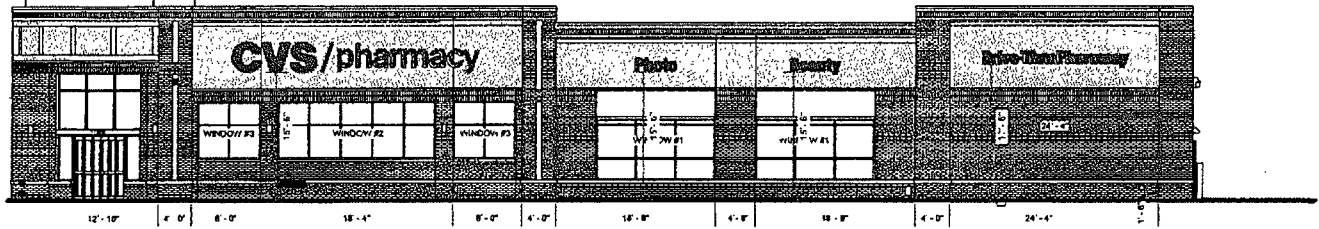

1225 Bowes Road, Elgin, IL 60123-5542
 Phone: 847.214.9595 ~ Fax 847.214.9596
 www.surelightsign.com

CVS CS 44830 Store 75487
NEC Madison & Kedzie
Chicago, IL

Date: 1/14/11

Revisions:
