



City of Chicago



O2020-4816

Office of the City Clerk

Document Tracking Sheet

Meeting Date:	10/7/2020
Sponsor(s):	Misc. Transmittal
Type:	Ordinance
Title:	Zoning Reclassification Map No. 3-I at 2815-2821 W Division St - App No. 20532T1
Committee(s) Assignment:	Committee on Zoning, Landmarks and Building Standards

#20532-T1
INTRO DATE
OCT 7, 2020

ORDINANCE

BE IT ORDAINED BY THE CITY COUNCIL OF THE CITY OF CHICAGO:

SECTION 1. Title 17 of the Municipal Code of Chicago, the Chicago Zoning Ordinance, is hereby amended by changing all the RS-3 Residential Single-Unit (Detached House) District symbols and indications as shown on Map No. 3-I in the area bounded by

West Division Street; a line 125 feet east of and parallel to North Mozart Street; the alley next south of and parallel to West Division Street; and a line 50 feet east of and parallel to North Mozart Street,

to those of an RM-6 Residential Multi-Unit District and a corresponding uses district is hereby established in the area above described.

SECTION 2. This ordinance shall be in force and effect from and after its passage and due publication.

Common address of property:

2815-21 West Division Street

17-13-0303-C (1) Narrative Zoning Analysis

2815-21 West Division Street, Chicago, Illinois

Proposed Zoning: RM-6 Residential Multi-Unit District

Lot Area: 9,374.75 square feet

Proposed Land Use: The Applicant is seeking a zoning change to permit one (1) additional dwelling unit within the existing multi-unit residential building, for a total of twenty-seven (27) units at the at the subject site. No changes are proposed to the height, setbacks, or footprint of the existing building. No onsite parking is or will be provided at the property.

- (A) The Project's Floor Area Ratio: 26,296 square feet (2.805 FAR)
- (B) The Project's Density (Minimum Lot Area Per D.U.): 347.213 sf/du (9,374.75sf/27du)
- (C) The amount of off-street parking: 0 vehicular parking spaces
- (D) Setbacks:
 - a. Front Setback: 0 feet-0 inches (Existing)
 - b. Rear Setback: 0 feet-0 inches (Existing)*
 - c. Side Setbacks:
 - West: 0 feet-0 inches (Existing)*
 - East: 0 foot-0 inches (Existing)*
- (E) Building Height:
 - 32 feet-6 inches (Existing)

*The Applicant will pursue a Variation to permit the existing (non-conforming) rear and side setbacks.

INTERIOR ALTERATIONS TO EXISTING THREE STORY 27 D.U. AND 1 COMMERCIAL UNIT BRICK BUILDING, WINDOW LINTELS REPLACEMENT PER PLAN.

CODE MATRIX

Code	Description	Section	Notes
101	General Building Code	101.01	...
102	Fire Code	102.01	...
103	Energy Code	103.01	...
104	Accessibility Code	104.01	...
105

NOTES

1. ALL WORK SHALL BE IN ACCORDANCE WITH THE CITY OF CHICAGO CODES AND ORDINANCES, THE IBC, AND THE IBC WITH CHICAGO AMENDMENTS.

2. THE EXISTING BUILDING IS A THREE STORY BRICK BUILDING WITH A COMMERCIAL UNIT ON THE FIRST FLOOR AND TWO DWELLING UNITS ON THE SECOND AND THIRD FLOORS.

3. THE PROPOSED WORK INCLUDES THE REPLACEMENT OF WINDOW LINTELS ON THE SECOND AND THIRD FLOORS.

4. THE EXISTING WINDOW LINTELS ARE MADE OF CAST IRON AND ARE IN POOR CONDITION.

5. THE PROPOSED WINDOW LINTELS ARE MADE OF ALUMINUM AND ARE TO BE INSTALLED IN ACCORDANCE WITH THE MANUFACTURER'S INSTRUCTIONS.

6. THE EXISTING WINDOW SILLINGS ARE TO BE REPAIRED AND REFINISHED.

7. THE EXISTING WINDOW CASINGS ARE TO BE REPAIRED AND REFINISHED.

8. THE EXISTING WINDOW GLAZING IS TO BE REMOVED AND REINSTALLED.

9. THE EXISTING WINDOW GLAZING IS TO BE REPAIRED AND REFINISHED.

10. THE EXISTING WINDOW GLAZING IS TO BE REPAIRED AND REFINISHED.

11. THE EXISTING WINDOW GLAZING IS TO BE REPAIRED AND REFINISHED.

12. THE EXISTING WINDOW GLAZING IS TO BE REPAIRED AND REFINISHED.

13. THE EXISTING WINDOW GLAZING IS TO BE REPAIRED AND REFINISHED.

14. THE EXISTING WINDOW GLAZING IS TO BE REPAIRED AND REFINISHED.

15. THE EXISTING WINDOW GLAZING IS TO BE REPAIRED AND REFINISHED.

16. THE EXISTING WINDOW GLAZING IS TO BE REPAIRED AND REFINISHED.

17. THE EXISTING WINDOW GLAZING IS TO BE REPAIRED AND REFINISHED.

18. THE EXISTING WINDOW GLAZING IS TO BE REPAIRED AND REFINISHED.

19. THE EXISTING WINDOW GLAZING IS TO BE REPAIRED AND REFINISHED.

20. THE EXISTING WINDOW GLAZING IS TO BE REPAIRED AND REFINISHED.

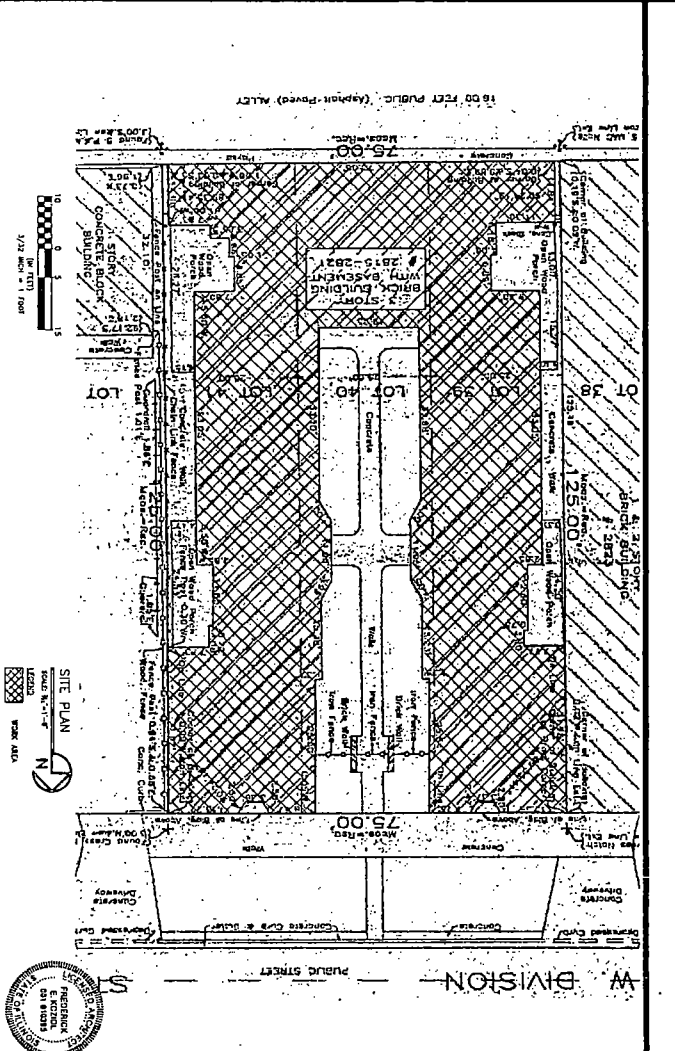

<h2 style="margin: 0;">ARCHITECT</h2> <h1 style="margin: 0;">RETS</h1> <p style="font-size: small;">1000 N. LAUREL ST. CHICAGO, IL 60610 773.777.2800 773.777.2801</p>	<p style="font-size: x-small;">I hereby certify that these plans were prepared or supervised by me or under my direct supervision and that I am a duly licensed professional engineer in the State of Illinois.</p> <p style="font-size: x-small;">I hereby certify that these plans were prepared or supervised by me or under my direct supervision and that I am a duly licensed professional engineer in the State of Illinois.</p> <p style="font-size: x-small;">I hereby certify that these plans were prepared or supervised by me or under my direct supervision and that I am a duly licensed professional engineer in the State of Illinois.</p>	<p style="font-size: x-small;">I hereby certify that these plans were prepared or supervised by me or under my direct supervision and that I am a duly licensed professional engineer in the State of Illinois.</p> <p style="font-size: x-small;">I hereby certify that these plans were prepared or supervised by me or under my direct supervision and that I am a duly licensed professional engineer in the State of Illinois.</p> <p style="font-size: x-small;">I hereby certify that these plans were prepared or supervised by me or under my direct supervision and that I am a duly licensed professional engineer in the State of Illinois.</p>
<p style="font-size: x-small;">PROJECT: INTERIOR ALTERATIONS TO EXISTING THREE STORY 27 D.U. AND 1 COMMERCIAL UNIT BRICK BUILDING, WINDOW LINTELS REPLACEMENT PER PLAN.</p> <p style="font-size: x-small;">SCALE: 1/8" = 1'-0"</p> <p style="font-size: x-small;">DATE: 08/13/2013</p> <p style="font-size: x-small;">DRAWN BY: [Name]</p>	<p style="font-size: x-small;">1. CODE MATRIX, NOTES & SITE PLAN</p> <p style="font-size: x-small;">2. EXISTING FLOOR PLAN</p> <p style="font-size: x-small;">3. PROPOSED FLOOR PLAN</p> <p style="font-size: x-small;">4. PROPOSED ELEVATIONS</p> <p style="font-size: x-small;">5. ELECTRICAL SCHEDULE</p> <p style="font-size: x-small;">6. MECHANICAL SCHEDULE</p>	<p style="font-size: x-small;">CODE MATRIX, NOTES, & SITE PLAN</p> <p style="font-size: x-small;">2815 W. DIVISION ST.</p> <p style="font-size: x-small;">CHICAGO, IL</p>

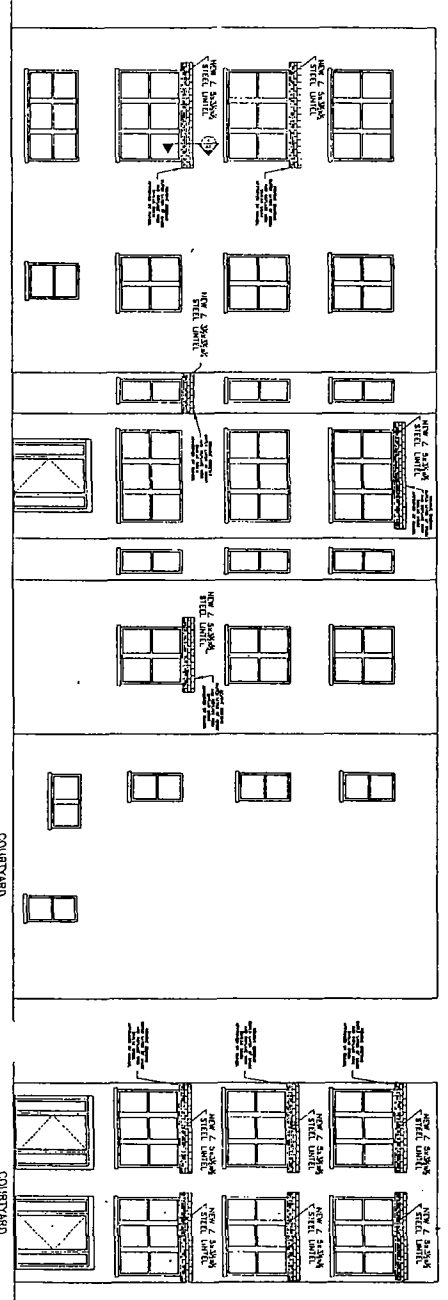

SEE SHEET T1 FOR
UNITEL AND MASONRY
NOTES

PROVIDE FLASHING AND
WEEPS WITH WINGS AT
18" O.C.

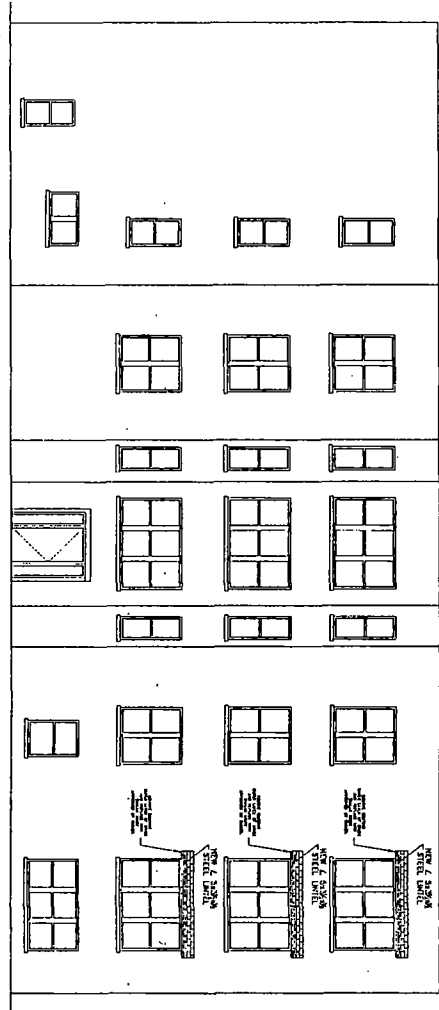

COURTYARD
EAST ELEVATION
SCALE 3/16" = 1'-0"

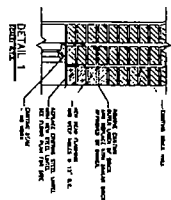

A3 <small>4 OF 12</small>	PROJECT: PRISONERSON SCALE: 3/16" = 1'-0" DATE: 12.14.2020	ARCHITECTURE PLANNING ARCHITECTS ARCHITECTURAL ENGINEERING	2152 N. DAMIAN AVE CHICAGO, IL 60647 312.772.8788 #666 312.772.2534 fax	2815 W. DIVISION ST CHICAGO, IL	PROPOSED ELEVATIONS AND DETAILS	DRAWING BY: JLN CHECKED BY: ST
	SHEET:	ARCHITECTURE	2152 N. DAMIAN AVE CHICAGO, IL 60647	2815 W. DIVISION ST CHICAGO, IL	PROPOSED ELEVATIONS AND DETAILS	DRAWING BY: JLN CHECKED BY: ST

PLAT OF SURVEY

LOTS 39, 40 AND 41 IN BLOCK 1 IN CARTER'S RESUBDIVISION OF BLOCKS 1, 3, 4, 5, 7, 8, 9, 10, 11, 13, 14, 15 AND LOTS 2, 4 AND 5 OF BLOCK 17 ALL IN CARTER'S SUBDIVISION OF BLOCKS 1, 2, 3, 4 AND 7 OF CLIFFORD'S ADDITION TO CHICAGO, BEING A SUBDIVISION OF THE SOUTHWEST QUARTER OF SECTION 1, TOWNSHIP 39 NORTH, RANGE 13, EAST OF THE THIRD PRINCIPAL MERIDIAN, IN COOK COUNTY, ILLINOIS.

DIVISION STREET

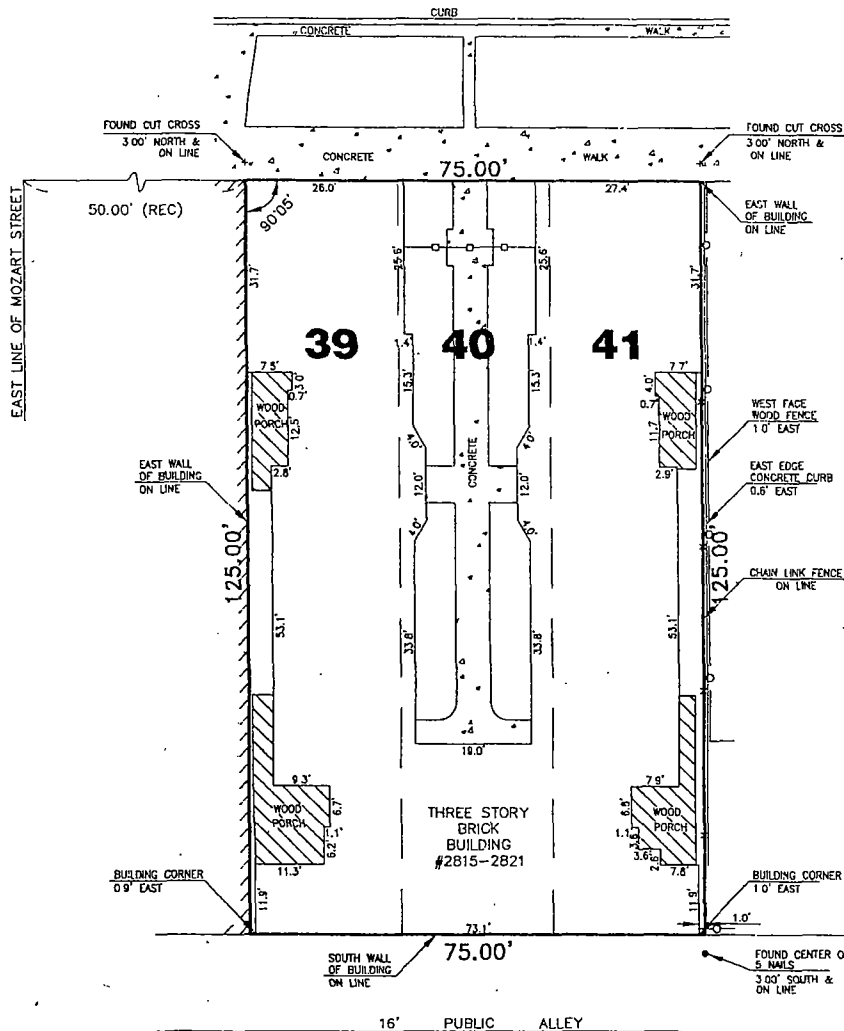

SUBJECT PROPERTY AREA
9,375 SQ. FT. (more or less)

PREPARED FOR: N. HASAN SYED

LANDMARK

ENGINEERING LLC
DESIGN FIRM REGISTRATION NO. 184-025577
7808 W. 103RD STREET
PALOS HILLS, ILLINOIS 60465-1529
Phone (708) 599-3737

BEARINGS SHOWN HEREON (IF ANY) ARE BASED ON ILL. S.P.C. EAST ZONE, NAD83. NO IMPROVEMENTS SHOULD BE CONSTRUCTED ON THE BASIS OF THIS PLAT ALONE AND NO DIMENSIONS, LENGTHS OR WIDTHS SHOULD BE ASSUMED FROM SCALING. FIELD MONUMENTATION OF CRITICAL POINTS SHOULD BE ESTABLISHED PRIOR TO COMMENCEMENT OF CONSTRUCTION.

FOR BUILDING LINES, EASEMENTS AND OTHER RESTRICTIONS NOT SHOWN HEREON, REFER TO DEEDS, ABSTRACTS, TITLE POLICIES, SEARCHES OR COMMITMENTS, CONTRACTS AND LOCAL BUILDING AND ZONING ORDINANCES.

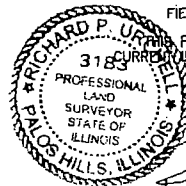

FIELD WORK COMPLETED: 09/08/2020
PROFESSIONAL SERVICE CONFORMS TO THE
CURRENT ILLINOIS STANDARDS FOR A BOUNDARY SURVEY.
DATED: 09/10/2020

Richard P. Urchell

RICHARD P. URCELL I.P.L.S. No. 3183
LICENSE RENEWAL DATE: NOVEMBER 30, 2025
SURVEY NO. 20-09-025



CITY OF CHICAGO
APPLICATION FOR AN AMENDMENT TO
THE CHICAGO ZONING ORDINANCE

#20532-T1
INTRO DATE
OCT 7, 2020

1. ADDRESS of the property Applicant is seeking to rezone:
2815-21 West Division Street, Chicago, Illinois

2. Ward Number that property is located in: 26

3. APPLICANT: 2815 Division LLC

ADDRESS: 2815 West Division Street CITY: Chicago

STATE: Illinois ZIP CODE: 60622 PHONE: 312-782-1983

EMAIL: nick@sambankslaw.com CONTACT PERSON: Nicholas J. Ftikas

4. Is the Applicant the owner of the property? YES NO

If the Applicant is not the owner of the property, please provide the following information regarding the owner and attach written authorization from the owner allowing the application to proceed.

OWNER: Same As Above

ADDRESS: _____ CITY: _____

STATE: _____ ZIP CODE: _____ PHONE: _____

EMAIL: _____ CONTACT PERSON: _____

5. If the Applicant/Owner of the property has obtained a lawyer as their representative for the rezoning, please provide the following information:

ATTORNEY: Nicholas J. Ftikas, Law Offices of Samuel V.P. Banks

ADDRESS: 221 North LaSalle Street, 38th Floor

CITY: Chicago STATE: Illinois ZIP CODE: 60601

PHONE: (312) 782-1983 FAX: 312-782-2433 EMAIL: nick@sambankslaw.com

6. If the Applicant is a legal entity (Corporation, LLC, Partnership, etc.), please provide the names of all owners as disclosed on the Economic Disclosure Statements.
Amir Syed – Manager
7. On what date did the owner acquire legal title to the subject property?
April 2011
8. Has the present owner previously rezoned this property? If Yes, when?
No
9. Present Zoning District: RS-3 Proposed Zoning District: RM-6
10. Lot size in square feet (or dimensions): 9,374.75 square feet
11. Current Use of the Property: The subject property is improved with a three-story, twenty-six (26) unit (non-conforming) residential building.
12. Reason for rezoning the property: The Applicant is seeking to permit one (1) additional dwelling unit within the existing building, for a total of twenty-seven (27) units at the subject property.
13. Describe the proposed use of the property after the rezoning. Indicate the number of dwelling unit number of parking spaces; approximate square footage of any commercial space; and height of the proposed building. (BE SPECIFIC): The Applicant is seeking a zoning change to permit one (1) additional dwelling unit within the existing multi-unit residential building, for a total of twenty-seven (27) units at the at the subject site. No changes are proposed to the height, setbacks, or footprint of the existing building. No onsite parking is or will be provided at the property.
14. The Affordable Requirements Ordinance (ARO) requires on-site affordable housing units and/or a financial contribution for residential housing projects with ten or more units that receive a zoning change which, among other triggers, increases the allowable floor area, or, for existing Planned Developments, increases the number of units (see attached fact sheet or visit www.cityofchicago.org/ARO for more information). Is this project subject to the ARO?
YES _____ NO X

COUNTY OF COOK
STATE OF ILLINOIS

I, AMIR SYED, being first duly sworn on oath, state that all of the above statements and the statements contained in the documents submitted herewith are, to the best of my knowledge, true and correct.

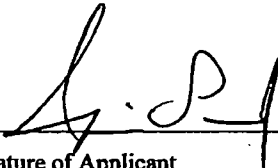
Signature of Applicant

Subscribed and Sworn to before me this
23rd day of SEPT., 2020.

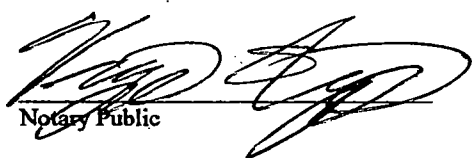
Notary Public



For Office Use Only

Date of Introduction: _____

File Number: _____

Ward: _____

Written Notice, Form of Affidavit: Section 17-13-0107

September 23, 2020

Honorable Thomas Tunney
Acting Chairman, Committee on Zoning
121 North LaSalle Street
Room 304 - City Hall
Chicago, Illinois 60602

To Whom It May Concern:

The undersigned, **Nicholas Ftikas**, being first duly sworn on oath, deposes and says the following:

That the undersigned certifies that he has complied with the requirements of Section 17-13-0107 of the Zoning Code of the City of Chicago, by sending written notice to such property owners who appear to be the owners of the property within the subject area not solely owned by the Applicant, and on the owners of all property within 250 feet in each direction of the lot line of the subject property, exclusive of the public roads, streets, alleys and other public ways, or a total distance limited to 400 feet. That said written notice was sent by USPS First Class Mail no more than 30 days before filing the application.

That the undersigned certifies that the notice contained the address of the property sought to be rezoned as **2815-21 West Division Street, Chicago, Illinois**; a statement of intended use of said property; the name and address of the Applicant and Property Owner; and a statement that the Applicant intends to file an application for a change in zoning on approximately **September 23, 2020**.

That the Applicant has made a bonafide effort to determine the addresses of the parties to be notified under Section 17-13-0107 of the Zoning Code of the City of Chicago and that the Applicant certifies that the accompanying list of names and addresses of surrounding property owners within 250 feet is a complete list containing the names and last known addresses of the owners of the property required to be served.

Law Offices of Samuel V.P. Banks

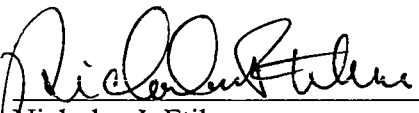
By: 
Nicholas J. Ftikas
Attorney for Applicant

Subscribed and Sworn to before me
this 23rd day of SEPT., 2020.

Notary Public

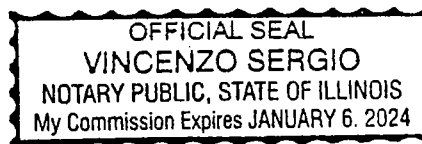

PUBLIC NOTICE

Via USPS First Class Mail

September 23, 2020

Dear Sir or Madam:

In accordance with the Amendment to the Chicago Zoning Code enacted by the City Council, Section 17-13-0107-A, please be informed that on or about **September 23, 2020**, I, the undersigned, intend to file an application for a change in zoning from an RS-3 Residential Single-Unit (Detached House) District to an RM-6 Residential Multi-Unit District, on behalf of the Applicant and Property Owner, 2815 Division LLC, for the property located at **2815-21 West Division Street, Chicago, Illinois**.

The Applicant is seeking a zoning change to permit one (1) additional dwelling unit within the existing multi-unit residential building, for a total of twenty-seven (27) units at the at the subject site. No changes are proposed to the height, setbacks, or footprint of the existing building. No onsite parking is or will be provided at the property.

The Applicant and Property Owner, **2815 Division LLC**, is located at 2815 West Division Street, Chicago, Illinois 60622.

I am the attorney for the Applicant. I will serve as the contact person for this zoning application. My address is 221 North LaSalle Street, 38th Floor, Chicago, Illinois 60601. My telephone number is (312)-782-1983.

Very truly yours,

Law Offices of Samuel V.P. Banks

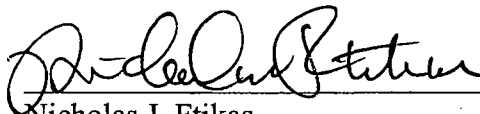

Nicholas J. Ftikas

Attorney for the Applicant

*****Please note that the Applicant is NOT seeking to purchase or rezone your property.**

*****The Applicant is required by law to send this notice because you own property located within 250 feet of the property subject to the proposed Zoning Amendment.**

**CITY OF CHICAGO
ECONOMIC DISCLOSURE STATEMENT
AND AFFIDAVIT**

SECTION I -- GENERAL INFORMATION

A. Legal name of the Disclosing Party submitting this EDS. Include d/b/a/ if applicable:

2815 Division LLC

Check ONE of the following three boxes:

Indicate whether the Disclosing Party submitting this EDS is:

1. the Applicant

OR

2. a legal entity currently holding, or anticipated to hold within six months after City action on the contract, transaction or other undertaking to which this EDS pertains (referred to below as the "Matter"), a direct or indirect interest in excess of 7.5% in the Applicant. State the Applicant's legal name: _____

OR

3. a legal entity with a direct or indirect right of control of the Applicant (see Section II(B)(1)) State the legal name of the entity in which the Disclosing Party holds a right of control: _____

B. Business address of the Disclosing Party: 2815 West Division Street

Chicago, Illinois 60622

C. Telephone: 312-782-1983 Fax: _____ Email: nick@sambankslaw.com

D. Name of contact person: Nicholas J. Ftikas - Attorney

E. Federal Employer Identification No. (if you have one): _____

F. Brief description of the Matter to which this EDS pertains. (Include project number and location of property, if applicable):

The Applicant is seeking a Zoning Map Amendment for the property located at 2815-21 West Division Street.

G. Which City agency or department is requesting this EDS? DPD/COZ

If the Matter is a contract being handled by the City's Department of Procurement Services, please complete the following:

Specification # _____ and Contract # _____

SECTION II -- DISCLOSURE OF OWNERSHIP INTERESTS

A. NATURE OF THE DISCLOSING PARTY

1. Indicate the nature of the Disclosing Party:

- | | |
|---|---|
| <input type="checkbox"/> Person | <input checked="" type="checkbox"/> Limited liability company |
| <input type="checkbox"/> Publicly registered business corporation | <input type="checkbox"/> Limited liability partnership |
| <input type="checkbox"/> Privately held business corporation | <input type="checkbox"/> Joint venture |
| <input type="checkbox"/> Sole proprietorship | <input type="checkbox"/> Not-for-profit corporation |
| <input type="checkbox"/> General partnership | (Is the not-for-profit corporation also a 501(c)(3))? |
| <input type="checkbox"/> Limited partnership | <input type="checkbox"/> Yes <input type="checkbox"/> No |
| <input type="checkbox"/> Trust | <input type="checkbox"/> Other (please specify) |
-

2. For legal entities, the state (or foreign country) of incorporation or organization, if applicable:

Illinois

3. For legal entities not organized in the State of Illinois: Has the organization registered to do business in the State of Illinois as a foreign entity?

- Yes No Organized in Illinois

B. IF THE DISCLOSING PARTY IS A LEGAL ENTITY:

1. List below the full names and titles, if applicable, of: (i) all executive officers and all directors of the entity; (ii) **for not-for-profit corporations**, all members, if any, which are legal entities (if there are no such members, write "no members which are legal entities"); (iii) **for trusts, estates or other similar entities**, the trustee, executor, administrator, or similarly situated party; (iv) **for general or limited partnerships, limited liability companies, limited liability partnerships or joint ventures**, each general partner, managing member, manager or any other person or legal entity that directly or indirectly controls the day-to-day management of the Applicant.

NOTE: Each legal entity listed below must submit an EDS on its own behalf.

Name	Title
Amir Syed	Manager

2. Please provide the following information concerning each person or legal entity having a direct or indirect, current or prospective (i.e. within 6 months after City action) beneficial interest (including ownership) in excess of 7.5% of the Applicant. Examples of such an interest include shares in a corporation, partnership interest in a partnership or joint venture, interest of a member or manager in a

limited liability company, or interest of a beneficiary of a trust, estate or other similar entity. If none, state "None."

NOTE: Each legal entity listed below may be required to submit an EDS on its own behalf.

Name	Business Address	Percentage Interest in the Applicant
Amir Syed	1627 North Maplewood Avenue	100%
	Chicago, Illinois 60642	

SECTION III -- INCOME OR COMPENSATION TO, OR OWNERSHIP BY, CITY ELECTED OFFICIALS

Has the Disclosing Party provided any income or compensation to any City elected official during the 12-month period preceding the date of this EDS? Yes No

Does the Disclosing Party reasonably expect to provide any income or compensation to any City elected official during the 12-month period following the date of this EDS? Yes No

If "yes" to either of the above, please identify below the name(s) of such City elected official(s) and describe such income or compensation:

N/A

Does any City elected official or, to the best of the Disclosing Party's knowledge after reasonable inquiry, any City elected official's spouse or domestic partner, have a financial interest (as defined in Chapter 2-156 of the Municipal Code of Chicago ("MCC")) in the Disclosing Party?

Yes No

If "yes," please identify below the name(s) of such City elected official(s) and/or spouse(s)/domestic partner(s) and describe the financial interest(s).

N/A

SECTION IV -- DISCLOSURE OF SUBCONTRACTORS AND OTHER RETAINED PARTIES

The Disclosing Party must disclose the name and business address of each subcontractor, attorney, lobbyist (as defined in MCC Chapter 2-156), accountant, consultant and any other person or entity whom the Disclosing Party has retained or expects to retain in connection with the Matter, as well as the nature of the relationship, and the total amount of the fees paid or estimated to be paid. The Disclosing Party is not required to disclose employees who are paid solely through the Disclosing Party's regular payroll. If the Disclosing Party is uncertain whether a disclosure is required under this Section, the Disclosing Party must either ask the City whether disclosure is required or make the disclosure.

Name (indicate whether retained or anticipated to be retained)	Business Address	Relationship to Disclosing Party (subcontractor, attorney, lobbyist, etc.)	Fees (indicate whether paid or estimated.) NOTE: "hourly rate" or "t.b.d." is not an acceptable response.
Law Offices of Samuel VP Banks	221 N. LaSalle St., 38th Floor Chicago, IL 60601	Attorney	\$6,500 (est.)

(Add sheets if necessary)

Check here if the Disclosing Party has not retained, nor expects to retain, any such persons or entities.

SECTION V -- CERTIFICATIONS

A. COURT-ORDERED CHILD SUPPORT COMPLIANCE

Under MCC Section 2-92-415, substantial owners of business entities that contract with the City must remain in compliance with their child support obligations throughout the contract's term.

Has any person who directly or indirectly owns 10% or more of the Disclosing Party been declared in arrearage on any child support obligations by any Illinois court of competent jurisdiction?

Yes No No person directly or indirectly owns 10% or more of the Disclosing Party.

If "Yes," has the person entered into a court-approved agreement for payment of all support owed and is the person in compliance with that agreement?

Yes No

B. FURTHER CERTIFICATIONS

1. [This paragraph 1 applies only if the Matter is a contract being handled by the City's Department of Procurement Services.] In the 5-year period preceding the date of this EDS, neither the Disclosing Party nor any Affiliated Entity [see definition in (5) below] has engaged, in connection with the performance of any public contract, the services of an integrity monitor, independent private sector inspector general, or integrity compliance consultant (i.e., an individual or entity with legal, auditing, investigative, or other similar skills, designated by a public agency to help the agency monitor the activity of specified agency vendors as well as help the vendors reform their business practices so they can be considered for agency contracts in the future, or continue with a contract in progress).

2. The Disclosing Party and its Affiliated Entities are not delinquent in the payment of any fine, fee, tax or other source of indebtedness owed to the City of Chicago, including, but not limited to, water and sewer charges, license fees, parking tickets, property taxes and sales taxes, nor is the Disclosing Party delinquent in the payment of any tax administered by the Illinois Department of Revenue.

3. The Disclosing Party and, if the Disclosing Party is a legal entity, all of those persons or entities identified in Section II(B)(1) of this EDS:
- a. are not presently debarred, suspended, proposed for debarment, declared ineligible or voluntarily excluded from any transactions by any federal, state or local unit of government;
 - b. have not, during the 5 years before the date of this EDS, been convicted of a criminal offense, adjudged guilty, or had a civil judgment rendered against them in connection with: obtaining, attempting to obtain, or performing a public (federal, state or local) transaction or contract under a public transaction; a violation of federal or state antitrust statutes; fraud; embezzlement; theft; forgery; bribery; falsification or destruction of records; making false statements; or receiving stolen property;
 - c. are not presently indicted for, or criminally or civilly charged by, a governmental entity (federal, state or local) with committing any of the offenses set forth in subparagraph (b) above;
 - d. have not, during the 5 years before the date of this EDS, had one or more public transactions (federal, state or local) terminated for cause or default; and
 - e. have not, during the 5 years before the date of this EDS, been convicted, adjudged guilty, or found liable in a civil proceeding, or in any criminal or civil action, including actions concerning environmental violations, instituted by the City or by the federal government, any state, or any other unit of local government.
4. The Disclosing Party understands and shall comply with the applicable requirements of MCC Chapters 2-56 (Inspector General) and 2-156 (Governmental Ethics).
5. Certifications (5), (6) and (7) concern:
- the Disclosing Party;
 - any "Contractor" (meaning any contractor or subcontractor used by the Disclosing Party in connection with the Matter, including but not limited to all persons or legal entities disclosed under Section IV, "Disclosure of Subcontractors and Other Retained Parties");
 - any "Affiliated Entity" (meaning a person or entity that, directly or indirectly: controls the Disclosing Party, is controlled by the Disclosing Party, or is, with the Disclosing Party, under common control of another person or entity). Indicia of control include, without limitation: interlocking management or ownership; identity of interests among family members, shared facilities and equipment; common use of employees; or organization of a business entity following the ineligibility of a business entity to do business with federal or state or local government, including the City, using substantially the same management, ownership, or principals as the ineligible entity. With respect to Contractors, the term Affiliated Entity means a person or entity that directly or indirectly controls the Contractor, is controlled by it, or, with the Contractor, is under common control of another person or entity;
 - any responsible official of the Disclosing Party, any Contractor or any Affiliated Entity or any other official, agent or employee of the Disclosing Party, any Contractor or any Affiliated Entity, acting pursuant to the direction or authorization of a responsible official of the Disclosing Party, any Contractor or any Affiliated Entity (collectively "Agents").

Neither the Disclosing Party, nor any Contractor, nor any Affiliated Entity of either the Disclosing Party or any Contractor, nor any Agents have, during the 5 years before the date of this EDS, or, with respect to a Contractor, an Affiliated Entity, or an Affiliated Entity of a Contractor during the 5 years before the date of such Contractor's or Affiliated Entity's contract or engagement in connection with the Matter:

- a. bribed or attempted to bribe, or been convicted or adjudged guilty of bribery or attempting to bribe, a public officer or employee of the City, the State of Illinois, or any agency of the federal government or of any state or local government in the United States of America, in that officer's or employee's official capacity;
 - b. agreed or colluded with other bidders or prospective bidders, or been a party to any such agreement, or been convicted or adjudged guilty of agreement or collusion among bidders or prospective bidders, in restraint of freedom of competition by agreement to bid a fixed price or otherwise; or
 - c. made an admission of such conduct described in subparagraph (a) or (b) above that is a matter of record, but have not been prosecuted for such conduct; or
 - d. violated the provisions referenced in MCC Subsection 2-92-320(a)(4)(Contracts Requiring a Base Wage); (a)(5)(Debarment Regulations); or (a)(6)(Minimum Wage Ordinance).
6. Neither the Disclosing Party, nor any Affiliated Entity or Contractor, or any of their employees, officials, agents or partners, is barred from contracting with any unit of state or local government as a result of engaging in or being convicted of (1) bid-rigging in violation of 720 ILCS 5/33E-3; (2) bid-rotating in violation of 720 ILCS 5/33E-4; or (3) any similar offense of any state or of the United States of America that contains the same elements as the offense of bid-rigging or bid-rotating.
7. Neither the Disclosing Party nor any Affiliated Entity is listed on a Sanctions List maintained by the United States Department of Commerce, State, or Treasury, or any successor federal agency.
8. [FOR APPLICANT ONLY] (i) Neither the Applicant nor any "controlling person" [see MCC Chapter 1-23, Article I for applicability and defined terms] of the Applicant is currently indicted or charged with, or has admitted guilt of, or has ever been convicted of, or placed under supervision for, any criminal offense involving actual, attempted, or conspiracy to commit bribery, theft, fraud, forgery, perjury, dishonesty or deceit against an officer or employee of the City or any "sister agency"; and (ii) the Applicant understands and acknowledges that compliance with Article I is a continuing requirement for doing business with the City. NOTE: If MCC Chapter 1-23, Article I applies to the Applicant, that Article's permanent compliance timeframe supersedes 5-year compliance timeframes in this Section V.
9. [FOR APPLICANT ONLY] The Applicant and its Affiliated Entities will not use, nor permit their subcontractors to use, any facility listed as having an active exclusion by the U.S. EPA on the federal System for Award Management ("SAM").

10. [FOR APPLICANT ONLY] The Applicant will obtain from any contractors/subcontractors hired or to be hired in connection with the Matter certifications equal in form and substance to those in Certifications (2) and (9) above and will not, without the prior written consent of the City, use any such

contractor/subcontractor that does not provide such certifications or that the Applicant has reason to believe has not provided or cannot provide truthful certifications.

11. If the Disclosing Party is unable to certify to any of the above statements in this Part B (Further Certifications), the Disclosing Party must explain below:

None

If the letters "NA," the word "None," or no response appears on the lines above, it will be conclusively presumed that the Disclosing Party certified to the above statements.

12. To the best of the Disclosing Party's knowledge after reasonable inquiry, the following is a complete list of all current employees of the Disclosing Party who were, at any time during the 12-month period preceding the date of this EDS, an employee, or elected or appointed official, of the City of Chicago (if none, indicate with "N/A" or "none").

None

13. To the best of the Disclosing Party's knowledge after reasonable inquiry, the following is a complete list of all gifts that the Disclosing Party has given or caused to be given, at any time during the 12-month period preceding the execution date of this EDS, to an employee, or elected or appointed official, of the City of Chicago. For purposes of this statement, a "gift" does not include: (i) anything made generally available to City employees or to the general public, or (ii) food or drink provided in the course of official City business and having a retail value of less than \$25 per recipient, or (iii) a political contribution otherwise duly reported as required by law (if none, indicate with "N/A" or "none"). As to any gift listed below, please also list the name of the City recipient.

None

C. CERTIFICATION OF STATUS AS FINANCIAL INSTITUTION

1. The Disclosing Party certifies that the Disclosing Party (check one)

is is not

a "financial institution" as defined in MCC Section 2-32-455(b).

2. If the Disclosing Party IS a financial institution, then the Disclosing Party pledges:

"We are not and will not become a predatory lender as defined in MCC Chapter 2-32. We further pledge that none of our affiliates is, and none of them will become, a predatory lender as defined in MCC Chapter 2-32. We understand that becoming a predatory lender or becoming an affiliate of a predatory lender may result in the loss of the privilege of doing business with the City."

If the Disclosing Party is unable to make this pledge because it or any of its affiliates (as defined in MCC Section 2-32-455(b)) is a predatory lender within the meaning of MCC Chapter 2-32, explain here (attach additional pages if necessary):

None

If the letters "NA," the word "None," or no response appears on the lines above, it will be conclusively presumed that the Disclosing Party certified to the above statements.

D. CERTIFICATION REGARDING FINANCIAL INTEREST IN CITY BUSINESS

Any words or terms defined in MCC Chapter 2-156 have the same meanings if used in this Part D.

1. In accordance with MCC Section 2-156-110: To the best of the Disclosing Party's knowledge after reasonable inquiry, does any official or employee of the City have a financial interest in his or her own name or in the name of any other person or entity in the Matter?

Yes

No

NOTE: If you checked "Yes" to Item D(1), proceed to Items D(2) and D(3). If you checked "No" to Item D(1), skip Items D(2) and D(3) and proceed to Part E.

2. Unless sold pursuant to a process of competitive bidding, or otherwise permitted, no City elected official or employee shall have a financial interest in his or her own name or in the name of any other person or entity in the purchase of any property that (i) belongs to the City, or (ii) is sold for taxes or assessments, or (iii) is sold by virtue of legal process at the suit of the City (collectively, "City Property Sale"). Compensation for property taken pursuant to the City's eminent domain power does not constitute a financial interest within the meaning of this Part D.

Does the Matter involve a City Property Sale?

Yes

No

3. If you checked "Yes" to Item D(1), provide the names and business addresses of the City officials or employees having such financial interest and identify the nature of the financial interest:

Name	Business Address	Nature of Financial Interest
------	------------------	------------------------------

N/A

4. The Disclosing Party further certifies that no prohibited financial interest in the Matter will be acquired by any City official or employee.

E. CERTIFICATION REGARDING SLAVERY ERA BUSINESS

Please check either (1) or (2) below. If the Disclosing Party checks (2), the Disclosing Party must disclose below or in an attachment to this EDS all information required by (2). Failure to comply with these disclosure requirements may make any contract entered into with the City in connection with the Matter voidable by the City.

1. The Disclosing Party verifies that the Disclosing Party has searched any and all records of the Disclosing Party and any and all predecessor entities regarding records of investments or profits from slavery or slaveholder insurance policies during the slavery era (including insurance policies issued to slaveholders that provided coverage for damage to or injury or death of their slaves), and the Disclosing Party has found no such records.

2. The Disclosing Party verifies that, as a result of conducting the search in step (1) above, the Disclosing Party has found records of investments or profits from slavery or slaveholder insurance policies. The Disclosing Party verifies that the following constitutes full disclosure of all such records, including the names of any and all slaves or slaveholders described in those records:

SECTION VI -- CERTIFICATIONS FOR FEDERALLY FUNDED MATTERS

NOTE: If the Matter is federally funded, complete this Section VI. If the Matter is not federally funded, proceed to Section VII. For purposes of this Section VI, tax credits allocated by the City and proceeds of debt obligations of the City are not federal funding.

A. CERTIFICATION REGARDING LOBBYING

1. List below the names of all persons or entities registered under the federal Lobbying Disclosure Act of 1995, as amended, who have made lobbying contacts on behalf of the Disclosing Party with respect to the Matter: (Add sheets if necessary):

(If no explanation appears or begins on the lines above, or if the letters "NA" or if the word "None" appear, it will be conclusively presumed that the Disclosing Party means that NO persons or entities registered under the Lobbying Disclosure Act of 1995, as amended, have made lobbying contacts on behalf of the Disclosing Party with respect to the Matter.)

2. The Disclosing Party has not spent and will not expend any federally appropriated funds to pay any person or entity listed in paragraph A(1) above for his or her lobbying activities or to pay any person or entity to influence or attempt to influence an officer or employee of any agency, as defined by applicable federal law, a member of Congress, an officer or employee of Congress, or an employee

of a member of Congress, in connection with the award of any federally funded contract, making any federally funded grant or loan, entering into any cooperative agreement, or to extend, continue, renew, amend, or modify any federally funded contract, grant, loan, or cooperative agreement.

3. The Disclosing Party will submit an updated certification at the end of each calendar quarter in which there occurs any event that materially affects the accuracy of the statements and information set forth in paragraphs A(1) and A(2) above.

4. The Disclosing Party certifies that either: (i) it is not an organization described in section 501(c)(4) of the Internal Revenue Code of 1986; or (ii) it is an organization described in section 501(c)(4) of the Internal Revenue Code of 1986 but has not engaged and will not engage in "Lobbying Activities," as that term is defined in the Lobbying Disclosure Act of 1995, as amended.

5. If the Disclosing Party is the Applicant, the Disclosing Party must obtain certifications equal in form and substance to paragraphs A(1) through A(4) above from all subcontractors before it awards any subcontract and the Disclosing Party must maintain all such subcontractors' certifications for the duration of the Matter and must make such certifications promptly available to the City upon request.

B. CERTIFICATION REGARDING EQUAL EMPLOYMENT OPPORTUNITY

If the Matter is federally funded, federal regulations require the Applicant and all proposed subcontractors to submit the following information with their bids or in writing at the outset of negotiations.

Is the Disclosing Party the Applicant?

Yes

No

If "Yes," answer the three questions below:

1. Have you developed and do you have on file affirmative action programs pursuant to applicable federal regulations? (See 41 CFR Part 60-2.)

Yes

No

2. Have you filed with the Joint Reporting Committee, the Director of the Office of Federal Contract Compliance Programs, or the Equal Employment Opportunity Commission all reports due under the applicable filing requirements?

Yes

No

Reports not required

3. Have you participated in any previous contracts or subcontracts subject to the equal opportunity clause?

Yes

No

If you checked "No" to question (1) or (2) above, please provide an explanation:

SECTION VII -- FURTHER ACKNOWLEDGMENTS AND CERTIFICATION

The Disclosing Party understands and agrees that:

A. The certifications, disclosures, and acknowledgments contained in this EDS will become part of any contract or other agreement between the Applicant and the City in connection with the Matter, whether procurement, City assistance, or other City action, and are material inducements to the City's execution of any contract or taking other action with respect to the Matter. The Disclosing Party understands that it must comply with all statutes, ordinances, and regulations on which this EDS is based.

B. The City's Governmental Ethics Ordinance, MCC Chapter 2-156, imposes certain duties and obligations on persons or entities seeking City contracts, work, business, or transactions. The full text of this ordinance and a training program is available on line at www.cityofchicago.org/Ethics, and may also be obtained from the City's Board of Ethics, 740 N. Sedgwick St., Suite 500, Chicago, IL 60610, (312) 744-9660. The Disclosing Party must comply fully with this ordinance.

C. If the City determines that any information provided in this EDS is false, incomplete or inaccurate, any contract or other agreement in connection with which it is submitted may be rescinded or be void or voidable, and the City may pursue any remedies under the contract or agreement (if not rescinded or void), at law, or in equity, including terminating the Disclosing Party's participation in the Matter and/or declining to allow the Disclosing Party to participate in other City transactions. Remedies at law for a false statement of material fact may include incarceration and an award to the City of treble damages.

D. It is the City's policy to make this document available to the public on its Internet site and/or upon request. Some or all of the information provided in, and appended to, this EDS may be made publicly available on the Internet, in response to a Freedom of Information Act request, or otherwise. By completing and signing this EDS, the Disclosing Party waives and releases any possible rights or claims which it may have against the City in connection with the public release of information contained in this EDS and also authorizes the City to verify the accuracy of any information submitted in this EDS.

E. The information provided in this EDS must be kept current. In the event of changes, the Disclosing Party must supplement this EDS up to the time the City takes action on the Matter. If the Matter is a contract being handled by the City's Department of Procurement Services, the Disclosing Party must update this EDS as the contract requires. **NOTE:** With respect to Matters subject to MCC Chapter 1-23, Article I (imposing **PERMANENT INELIGIBILITY** for certain specified offenses), the information provided herein regarding eligibility must be kept current for a longer period, as required by MCC Chapter 1-23 and Section 2-154-020.

CERTIFICATION

Under penalty of perjury, the person signing below: (1) warrants that he/she is authorized to execute this EDS, and all applicable Appendices, on behalf of the Disclosing Party, and (2) warrants that all certifications and statements contained in this EDS, and all applicable Appendices, are true, accurate and complete as of the date furnished to the City.

2815 DIVISION LLC

(Print or type exact legal name of Disclosing Party)

By: [Signature]
(Sign here)

AMIR SYED

(Print or type name of person signing)

MANAGER

(Print or type title of person signing)

Signed and sworn to before me on (date) 9-21-20,

at COOK County, IL (state).

[Signature]
Notary Public

Commission expires: 1-6-24

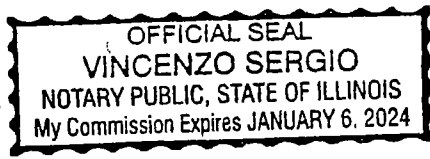

**CITY OF CHICAGO
ECONOMIC DISCLOSURE STATEMENT AND AFFIDAVIT
APPENDIX A**

**FAMILIAL RELATIONSHIPS WITH ELECTED CITY OFFICIALS
AND DEPARTMENT HEADS**

This Appendix is to be completed only by (a) the Applicant, and (b) any legal entity which has a direct ownership interest in the Applicant exceeding 7.5%. It is not to be completed by any legal entity which has only an indirect ownership interest in the Applicant.

Under MCC Section 2-154-015, the Disclosing Party must disclose whether such Disclosing Party or any "Applicable Party" or any Spouse or Domestic Partner thereof currently has a "familial relationship" with any elected city official or department head. A "familial relationship" exists if, as of the date this EDS is signed, the Disclosing Party or any "Applicable Party" or any Spouse or Domestic Partner thereof is related to the mayor, any alderman, the city clerk, the city treasurer or any city department head as spouse or domestic partner or as any of the following, whether by blood or adoption: parent, child, brother or sister, aunt or uncle, niece or nephew, grandparent, grandchild, father-in-law, mother-in-law, son-in-law, daughter-in-law, stepfather or stepmother, stepson or stepdaughter, stepbrother or stepsister or half-brother or half-sister.

"Applicable Party" means (1) all executive officers of the Disclosing Party listed in Section II.B.1.a., if the Disclosing Party is a corporation; all partners of the Disclosing Party, if the Disclosing Party is a general partnership; all general partners and limited partners of the Disclosing Party, if the Disclosing Party is a limited partnership; all managers, managing members and members of the Disclosing Party, if the Disclosing Party is a limited liability company; (2) all principal officers of the Disclosing Party; and (3) any person having more than a 7.5% ownership interest in the Disclosing Party. "Principal officers" means the president, chief operating officer, executive director, chief financial officer, treasurer or secretary of a legal entity or any person exercising similar authority.

Does the Disclosing Party or any "Applicable Party" or any Spouse or Domestic Partner thereof currently have a "familial relationship" with an elected city official or department head?

Yes

No

If yes, please identify below (1) the name and title of such person, (2) the name of the legal entity to which such person is connected; (3) the name and title of the elected city official or department head to whom such person has a familial relationship, and (4) the precise nature of such familial relationship.

N/A

**CITY OF CHICAGO
ECONOMIC DISCLOSURE STATEMENT AND AFFIDAVIT
APPENDIX B**

BUILDING CODE SCOFFLAW/PROBLEM LANDLORD CERTIFICATION

This Appendix is to be completed only by (a) the Applicant, and (b) any legal entity which has a direct ownership interest in the Applicant exceeding 7.5% (an "Owner"). It is not to be completed by any legal entity which has only an indirect ownership interest in the Applicant.

1. Pursuant to MCC Section 2-154-010, is the Applicant or any Owner identified as a building code scofflaw or problem landlord pursuant to MCC Section 2-92-416?

Yes

No

2. If the Applicant is a legal entity publicly traded on any exchange, is any officer or director of the Applicant identified as a building code scofflaw or problem landlord pursuant to MCC Section 2-92-416?

Yes

No

The Applicant is not publicly traded on any exchange.

3. If yes to (1) or (2) above, please identify below the name of each person or legal entity identified as a building code scofflaw or problem landlord and the address of each building or buildings to which the pertinent code violations apply.

N/A

**CITY OF CHICAGO
ECONOMIC DISCLOSURE STATEMENT AND AFFIDAVIT
APPENDIX C**

PROHIBITION ON WAGE & SALARY HISTORY SCREENING - CERTIFICATION

This Appendix is to be completed only by an Applicant that is completing this EDS as a “contractor” as defined in MCC Section 2-92-385. That section, which should be consulted (www.amlegal.com), generally covers a party to any agreement pursuant to which they: (i) receive City of Chicago funds in consideration for services, work or goods provided (including for legal or other professional services), or (ii) pay the City money for a license, grant or concession allowing them to conduct a business on City premises.

On behalf of an Applicant that is a contractor pursuant to MCC Section 2-92-385, I hereby certify that the Applicant is in compliance with MCC Section 2-92-385(b)(1) and (2), which prohibit: (i) screening job applicants based on their wage or salary history, or (ii) seeking job applicants’ wage or salary history from current or former employers. I also certify that the Applicant has adopted a policy that includes those prohibitions.

Yes

No

N/A – I am not an Applicant that is a “contractor” as defined in MCC Section 2-92-385.

This certification shall serve as the affidavit required by MCC Section 2-92-385(c)(1).

If you checked “no” to the above, please explain.

N/A
