



Office of the Chicago City
Clerk



O2011-5453

Office of the City Clerk

Tracking Sheet

Meeting Date:	7/6/2011
Sponsor(s):	City Clerk Mendoza
Type:	Ordinance
Title:	Zoning Reclassification App No. 17290
Committee(s) Assignment:	Committee on Zoning, Landmarks and Building Standards

ORDINANCE

BE IT ORDAINED BY THE CITY COUNCIL OF THE CITY OF CHICAGO:

SECTION 1. Title 17, of the Municipal Code of Chicago, the Chicago Zoning Ordinance be amended by changing all the M1-2 Limited Manufacturing / Business Park District and M3-3 Heavy Industry District symbols and indications as shown on Map No. 5-G in the area bounded by

beginning at a line 100 feet southwest of and parallel to North Clybourn Avenue; a line 230.22 feet southeast of the intersection of North Ashland Avenue and North Clybourn Avenue, as measured along the westerly right-of-way line of North Clybourn Avenue and perpendicular thereto; North Clybourn Avenue; a line 280.22 feet southeast of the intersection of North Ashland Avenue and North Clybourn Avenue, as measured along the westerly right-of-way line of North Clybourn Avenue and perpendicular thereto; a line 100 feet southwest of and parallel to North Clybourn Avenue; a line 427.72 feet southeast of the intersection of North Ashland Avenue and North Clybourn Avenue, as measured along the westerly right-of-way of North Clybourn Avenue and perpendicular thereto; North Clybourn Avenue; a line 702.71 feet southeast of the intersection of North Ashland Avenue and North Clybourn Avenue as measured along the westerly right-of-way line North Clybourn Avenue and perpendicular thereto; a line 138.11 feet southwest of and parallel to North Clybourn Avenue; the alley next north of West Webster Avenue; the easterly right-of-way line of North Dominick Street; a line 453.6 feet north and northwest of West Webster Avenue, as measured along the easterly right-of-way line of North Dominick Street and perpendicular thereto; a line from a point, 216 feet north of West Webster Avenue and 152 feet east of North Ashland Avenue; to a point, 288 feet north of West Webster Avenue and 44 feet east of North Ashland Avenue (said curved line being concave and mning to the northwest having an arc length of 120.76 feet and a radius of 478.34 feet); a line from a point, 288 feet north of West Webster Avenue and 44 feet east of North Ashland Avenue; to a point, 412.56 feet south of the intersection of North Clybourn Avenue and North Ashland Avenue, as measured along the east bridge line of North Ashland Avenue and the east right-of-way line of North Ashland Avenue; and centerline of North Ashland Avenue (ToB),

to those of a C2-2 Motor Vehicle-Related Commercial District and a corresponding use district is hereby established in the area above described.

(2)

SECTION 2. That Title 17 of the Municipal Code, the Chicago Zoning Ordinance be amended by changing all the C2-2 Motor Vehicle-Related District symbols and indications within the area hereinabove described to the designation of Institutional-Business Planned Development Number _____, which is hereby established in the area above described, subject to such use and bulk regulations as are set forth in the Plan of Development herewith attached and made a part thereof and to no others.

SECTION 3. This ordinance shall be in force and effect from and after its passage and due publication.

Common Address of Property: 2258 North Clybourn Avenue

CITY OF CHICAGO
APPLICATION FOR AN AMENDMENT TO
THE CHICAGO ZONING ORDINANCE

#17290
INT. OFF.
7-6-11

1. ADDRESS of the property Applicant is seeking to rezone:
2258 North Clybourn
2. Ward Number that property is located in: 32
3. APPLICANT: The Salvation Army, an Illinois corporation c/o Law Offices of Samuel VP Banks, 221 N. LaSalle, Suite 3800, Chicago, IL 60601

ADDRESS: .10 W. Algonquin Rd.

CITY: Des Plaines STATE: IL ZIP CODE: 60016

PHONE: (312) 782-1983 CONTACT PERSON: Sylvia C. Michas, Esq.
Attorney for Applicant

4. Is the Applicant the owner of the property YES X NO
If the Applicant is not the owner of the property, please provide the following information regarding the owner and attach written authorization from the owner allowing the application to proceed.

OWNER Same as Above

ADDRESS _____

CITY _____ STATE _____ ZIP CODE _____

PHONE _____ CONTACT PERSON _____

5. If the Applicant/Owner of the property has obtained a lawyer as their representative for the rezoning, please provide the following information:

ATTORNEY Law Offices of Samuel VP Banks

ADDRESS 221 North LaSalle Street #3800

CITY Chicago STATE: IL ZIP CODE 60601

PHONE: (312) 782-1983 FAX: (312) 782-2433

6. If the applicant is a legal entity (Corporation, LLC, Partnership, etc.), please provide the names of all owners as disclosed on the Economic Disclosure Statements
The Salvation Army, an Illinois corporation

7. On what date did the owner acquire legal title to the subject property?
1932

8. Has the present owner previously rezoned this property? If Yes, when?
no

9. Present Zoning: M1-2 Limited Manufacturing/Business Park District and M3-3 Heavy Industry District

Proposed Zoning: C2-2 Motor Vehicle-Related Commercial District then to an Institutional-Business Planned Development

10. Lot size in square feet (or dimensions?): Oddly shaped lot = 206,032 sq. ft. (4.73 acres)

11. Current Use of the Property The subject property is currently improved with a two 1-story brick buildings, two 2-story brick buildings, one 1&2 story brick and stucco building, one 3-story brick buildings and .

12. Reason for rezoning the property: To permit the rehabilitation, reconstruction and expansion of the existing Salvation Army ARC center.

13. Describe the proposed use of the property after the rezoning. Indicate the number of dwelling units; number of parking spaces; approximate square footage of any commercial space; and height of the proposed building. (BE SPECIFIC)

The Planned Development is required in order to a) construct a new family store containing 34,900 sq. ft, b) construct a new maintenance building containing 12,000 sq. ft; c) permit the expansion of the adult rehabilitation center (14,934 sq. ft). The proposed height of the buildings included in the PD shall not exceed 36'. The Planned Development shall also include 145 on-site parking spaces.

14. On May 14, 2007, the Chicago City Council passed the Affordable Requirements Ordinance (ARO) that requires on-site affordable housing units or a financial contribution if residential housing projects receive a zoning change under certain circumstances. Based on the lot size of the project in question and the proposed zoning classification, is this project subject to the Affordable Requirements Ordinance? (See Fact Sheet for more information)

YES _____ NO X

=====
COUNTY OF COOK
STATE OF ILLINOIS

I, Bramwell E. Higgins, on behalf of The Salvation Army, an Illinois corporation, being first duly sworn on oath, states that all of the above statements and the statements contained in the documents submitted herewith are true and correct.

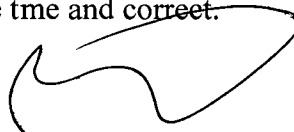

Signature of Applicant

Subscribed and Sworn to before me this

28th day of June, 2011.

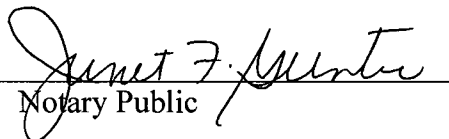

Notary Public



=====
For Office Use Only

Date of Introduction: _____

File Number: _____

Ward: _____

INSTITUTIONAL-BUSINESS PLANNED DEVELOPMENT No. _____

PLAN OF DEVELOPMENT STATEMENTS

1. The area delineated herein as Institutional-Business Planned Development No. _____, (the "Planned Development") consists of approximately one hundred seventy-nine thousand, nine hundred twenty-two (175,922) square feet (plus or minus four point zero three (4.03) acres) of property which is depicted on the attached Planned Development Boundary and Property Line Map (the "Property") and is owned or controlled by the Applicant, "The Salvation Army, an Illinois corporation".
2. All applicable official reviews, approvals or permits are required to be obtained by the applicant or its successors, assignees or grantees. Any dedication or vacation of streets, alleys or easements or any adjustment of the right-of-way shall require a separate submittal on behalf of the applicant or its successors, assignees or grantees and approval by the City Council.
3. The requirements, obligations and conditions contained within this Planned Development shall be binding upon the Applicant, its successors and assigns and, if different than the Applicant, the legal title holders and any ground lessors. All rights granted hereunder to the Applicant shall inure to the benefit of the applicant's successors and assigns and, if different than the applicant, the legal title holder and any ground lessors. Furthermore, pursuant to the requirements of Section 17-8-0400 of the Chicago Zoning Ordinance, the Property, at the time application for amendments, modifications or changes (administrative, legislative or otherwise) to this Planned Development are made, shall be under single ownership or designated control. Designated control for the purpose of this paragraph shall mean that any application to the City for any amendments to this Planned Development or any other modification or change thereto (administrative, legislative or otherwise) shall be made or authorized by the owners of the Property and any ground lessors. An agreement among property owners, the board of directors of any property owners association, or a covenant binding property owner, may designate the authorized party for any future amendment, modification or change.
4. This Plan of Development consists of seventeen (17) Statements: a Bulk Regulations and Data Table; an Existing Zoning Map; a Planned Development Boundary and Property Line Map, an Existing Land-Use Map, Site Plan, Master Plan & Landscape Plan, Family Store Site, Maintenance Building Site Plan and Building Elevations prepared by Antunovich Associates Architects & Planners dated July 6, 2011, submitted herein. Full sized copies of the Site Plan, Master Plan & Landscape Plan

Applicant: The Salvation Army, an Illinois corporation
Address: 2258 North Clybourn Avenue, Chicago, Illinois
Date: July 6, 2011
Revised:

and Building Elevations are on file with the Department of Housing and Economic Development (“DHED”). These and no other zoning controls shall apply to the Property. This Planned Development is applicable to the area delineated hereto and these and no other zoning controls shall apply. In any instance where a provision of this Planned Development conflicts with the Chicago Building Code, the Building Code shall apply. This Planned Development conforms to the intent and purpose of the Chicago Zoning Ordinance, Title 17 of the Municipal Code of Chicago and all requirements thereto and satisfies the established criteria for approval as a Planned Development.

5. The following uses are allowed in the area delineated herein as an “Institutional-Business Planned Development”: retail/business (ARC family store) uses, commercial uses, household living-transitional residences (adult rehab center) with related uses, public and civic uses-religious assembly, service uses, motor vehicle service and repair (maintenance shop) with related and accessory uses and off- street parking and loading as allowed by the C2-2 district classification.
6. On-Premise signs and temporary signs such as construction and marketing signs shall be permitted within the Planned Development subject to the review and approval of the Department of Housing and Economic Development (“DHED”). Off-Premise sign are prohibited within the boundary of this Planned Development.
7. Off-street parking and loading facilities shall be provided in compliance with this Planned Development subject to the review of the Department of Transportation and the approval of the Department of Housing and Economic Development (“DHED”).
8. Ingress or egress shall be subject to the review and approval by the Department of Transportation (CDOT) and the Department of Housing and Economic Development (DHED). Closure of all or any public street or alley during demolition or construction shall be subject to the review and approval of the Chicago Department of Transportation. All work proposed in the public way must be designed and constructed in accordance with the Chicago Department of Transportation Construction Standards for Work in the Public Way and in compliance with the Municipal Code of the City of Chicago.
9. The height of any building or any appurtenance attached shall not exceed the height established in the Bulk Regulations and Data Table and Building Elevations and shall also be subject to height limitations established by the (FAA) Federal Aviation Administration.

Applicant: The Salvation Army, an Illinois corporation
Address: 2258 North Clybourn Avenue, Chicago, Illinois
Date: July 6, 2011
Revised:

(3)

10. The maximum permitted floor area ratio (F.A.R.) for the parcel shall be in accordance with the attached Bulk Regulations and Data Table. For the purposes of floor area ratio calculations and floor area measurements, the definitions in the Chicago Zoning Ordinance shall apply.
11. The City of Chicago established a Part II Review Fee in the Amount of \$ 0.25 per square feet for the total buildable square feet (floor area ratio). The Part II Review Fee is assessed by DHED during the actual Part II Review. The fee as determined By DZLUP staff at that time is final and binding on the Applicant and must be paid to the Department of Revenue prior to the issuance of any Part II Approval.
12. The improvements on the property, including the on-site exterior landscaping and the landscaping along the adjacent rights-of-way and all entrances and exits to and from the parking and loading areas, shall be designed, constructed and maintained in substantial conformance with the Site Plan /Landscape Plan. In addition, parkway trees shall be installed and maintained in accordance with the parkway tree planting provisions of the Chicago Zoning Ordinance and corresponding regulations and guidelines.
13. The terms, conditions and exhibits this the Planned Development ordinance may be modified administratively, by the Commissioner of the Department of Housing and Economic Development upon the application for such a modification by the Applicant or its successors or assigns and a determination by the Commissioner of the Department of Housing and Economic Development that such modification is minor, appropriate and consistent with the nature of the improvements contemplated by this Planned Development and the purposes underlying the provisions hereof Any modification of the requirements of the Planned Development by the Commissioner of Housing and Economic Development shall be deemed to be a minor change in the Planned Development as contemplated by Section 17-13-0611-A of the Chicago Zoning Ordinance. Such minor changes may include an increase in the height of the building; periphery setbacks and an increase in the maximum percentage of land coverage; or other changes to the site plan or Plan of Development including an increase to the maximum retail/commercial square footage. For minor changes requested by the Applicant or the Designated Controlling Party, the consent of all owners is not required.

Applicant: The Salvation Army, an Illinois corporation
Address: 2258 North Clybourn Avenue, Chicago, Illinois
Date: July 6, 2011
Revised:

14. The Applicant acknowledges that it is in the public interest to design, construct and maintain the project in a manner which promotes, enables and maximizes universal access throughout the Property. Plans for all buildings and improvements on the Property shall be reviewed and approved by the Mayor's Office for People with Disabilities ("MOPD") to ensure compliance with all applicable laws and regulations related to access for persons with disabilities and to promote the highest standard of accessibility. No building permit shall be issued by the Department of Buildings until the Director of MOPD has approved detailed construction drawings for the building or improvement proposed.
15. The Applicant will comply with Rules and Regulations for the Maintenance of Stockpiles Promulgated by the Commissioner of Street and Sanitation, the Commissioner of the Environment and the Commissioner of Buildings pursuant to Section 13-32-125 of the Municipal Code of Chicago or any other provision of that Code.
16. The Applicant acknowledges that it is in the public interest to design, construct and maintain all buildings in a manner that provides healthier indoor environments, reduces operating costs and conserves energy and natural resources. All development shall be in substantial compliance with the current City of Chicago Sustainable Development policy set forth by the DHED. The proposed ARC family store shall provide a vegetated ("green") roof totaling a minimum of 50 % of the net roof area or 11,600 square feet and obtain an LEED's certification.
17. Unless substantial construction of any improvements as contemplated by this Planned Development amendment has commenced within six (6) years following adoption of this Planned Development, and unless completion thereof is diligently pursued, then this Planned Development shall expire and the zoning of the Property shall automatically revert to its prior M1-2 Limited Manufacturing / Business Park and M3-3 Heavy Industry Districts. This six (6) year period may be extended for up to one additional year if, before expiration of the six (6) year period, the Commissioner of Housing and Economic Development determines that good cause for an extension is shown.

Applicant: The Salvation Army, an Illinois corporation
Address: 2258 North Clybourn Avenue, Chicago, Illinois
Date: July 6, 2011
Revised:

INSTITUTIONAL-BUSINESS PLANNED DEVELOPMENT NUMBER _____

BULK REGULATIONS AND DATA TABLE

Gross Site Area:	206,032 square feet (4.73 acres)
Area in Public R.O.W.:	30,110 square feet (0.70 acres)
Net Site Area:	175,922 square feet (4.03 acres)
Permitted Floor Area Ratio:	2.2
Permitted Uses:	Business uses, services uses, institutional uses with accessory and related uses as referenced in Statement Number 5.
Maximum Retail/Commercial Area:	36,000 square feet
Maximum Number of Transitional / Residence beds/ rooms:	160 beds /30 rooms
Minimum Number of Accessory Off-Street Parking Spaces:	145 spaces
Minimum Number of Bicycle Parking Spaces:	19 spaces
Minimum Off-Street Loading Spaces:	1 @ 10' by 25'; and 2 @ 10' by 50'
Setbacks from Property Line:	In substantial compliance with the attached Site Plan
Maximum Percentage of Site Coverage:	In substantial compliance with the attached Site Plan
Maximum Building Height:	In substantial compliance with the attached Building Elevations
Setbacks from Property Lines:	In substantial compliance with the attached Site Plan
Applicant:	The Salvation Army, an Illinois corporation
Address:	2258 North Clybourn Avenue, Chicago, Illinois
Date:	July 6, 2011
Revised:	

Planned Development Exhibits

- A. Bulk Regulations and Data Table
- B. Existing Zoning Map
- C. Planned Development Boundary
- D. Existing Land Use Map
- E. Masterplan and Landscape Plan
- F1. Family Store Site Plan
- F2. Maintenance Building Site Plan
- G. Building Elevations

The Salvation Army ARC Family Store - Bulk and Data Summary

	Retail Store	Rehabilitation Center	Maintenance Building	Total	Notes/Remarks
Net Site Area				175,922.00 SF	
Gross Site Area				206,032.67 SF	
Site Coverage	36,000	26,000	12,000	74,000	
Building Area	36,000	60,000	12,000	108,000	
Proposed Floor Area Ratio				1.70	
Proposed Number of Transitional Residence Beds	0	30 Rooms	0	30 Rooms	160 Beds.
Proposed Number of Off-Street Parking Spaces	117	26	2	145	
Proposed Number of Off-Street Loading Berths	(1) 10' x 50' (1) 10' x 25'	0	(1) 10' x 50'	3	
Proposed Number Bicycle Parking Spaces	16	3	0	19	
Minimum Building Setbacks	Not Required	Not Required	Not Required		
Open Space	NA	NA	NA	NA	
Max. Building Height X = Existing, N = New	X = 2 Story, 24 ft N = 1 Story, 25 ft	X = 3 Story, 36'-8" N = 3 Story, 38 ft	X = 1 Story, 22 ft N = 1 Story, 25 ft		
Green Features	LEED Certification + 50% Green Roof	Building Certification (For new construction only.)	NA		

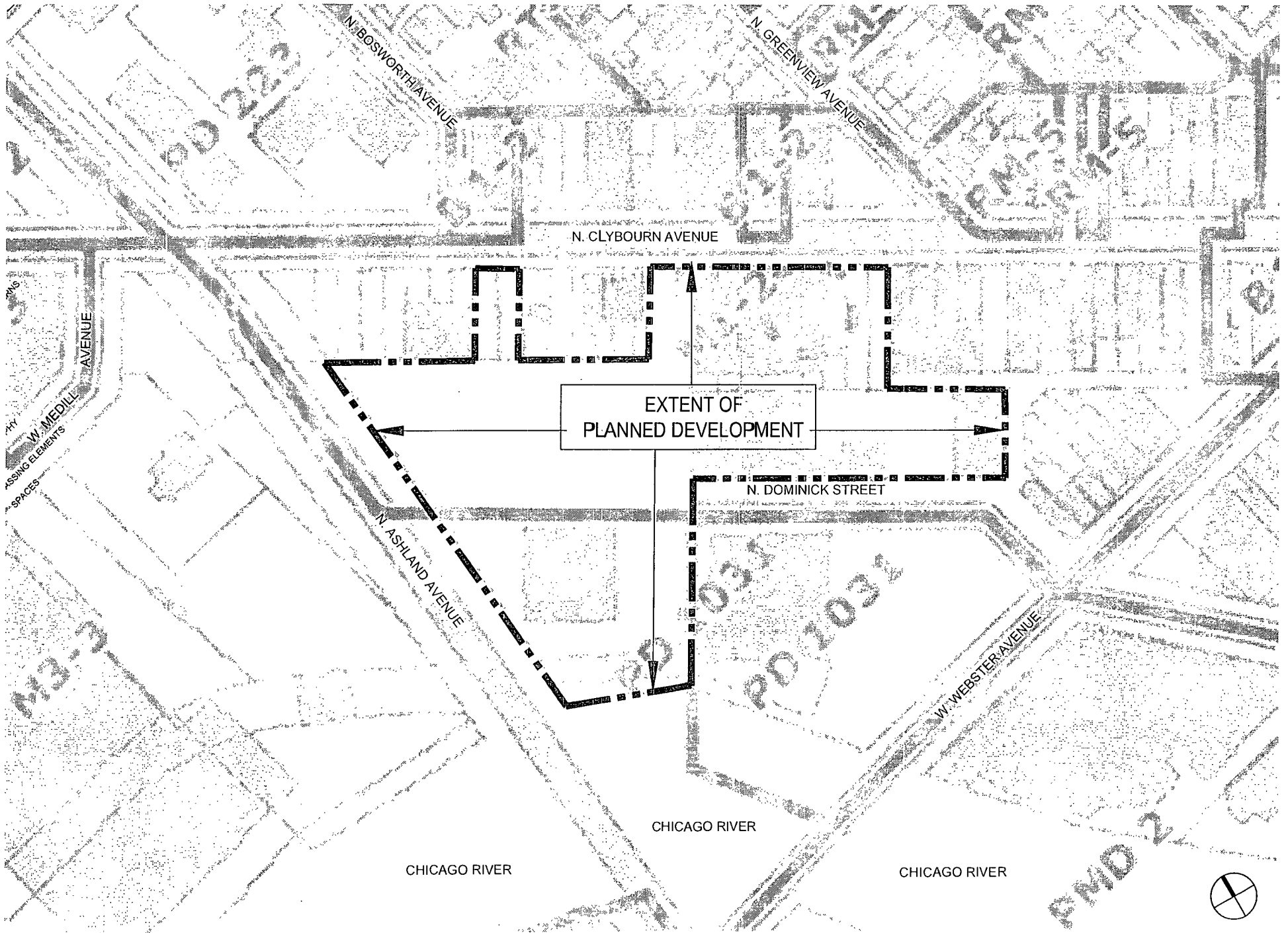

The Salvation Army Adult Rehabilitation Center - Planned Development

2258 N. Clybourn Avenue, Chicago, IL 60614

Antunovich Associates, Architects & Planners

B. Existing Zoning Map

July 06, 2011

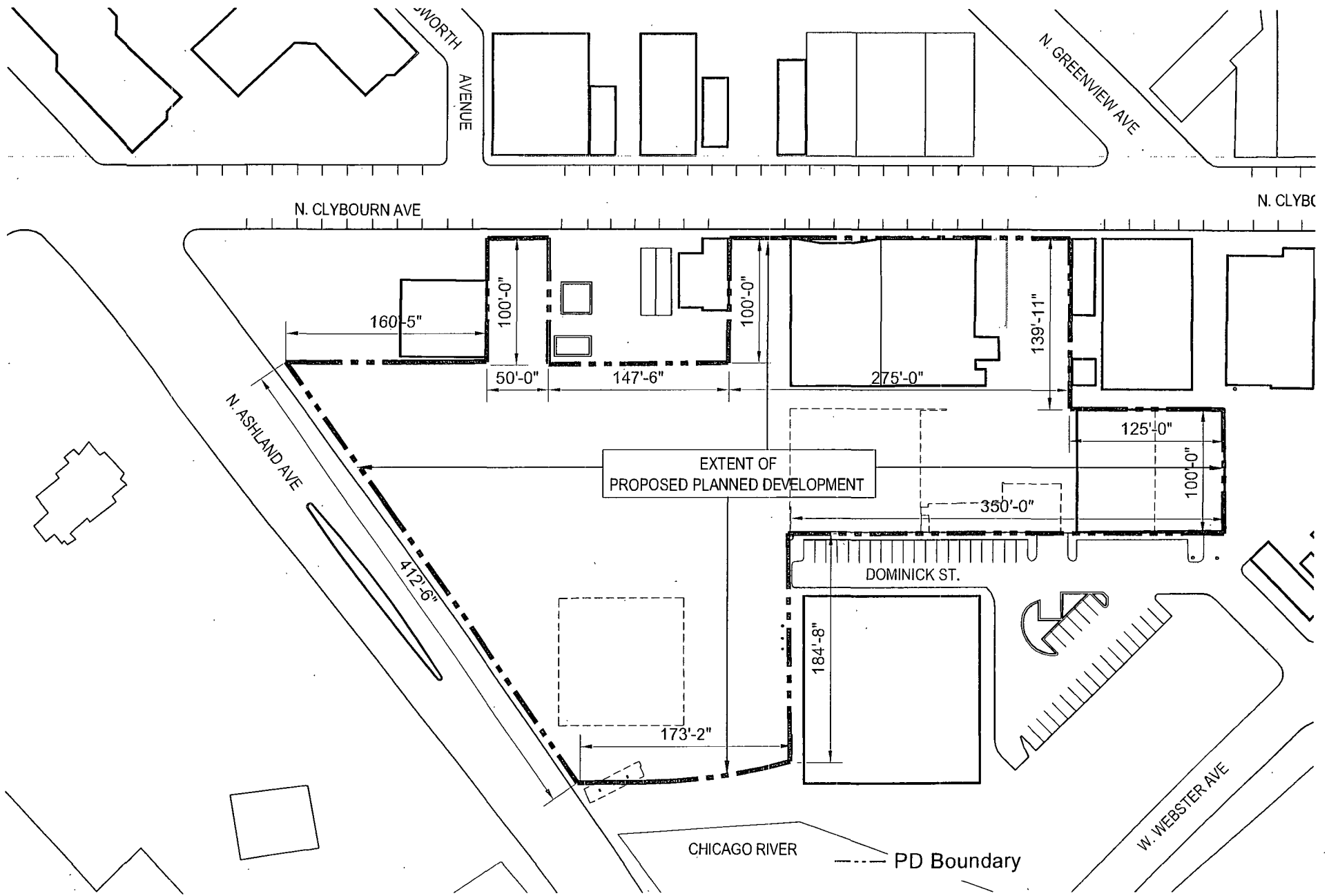

The Salvation Army Adult Rehabilitation Center - Planned Development

2258 N. Clybourn Avenue, Chicago, IL 60614
 Antunovich Associates, Architects & Planners

C. Planned Development Boundary

July 06, 2011

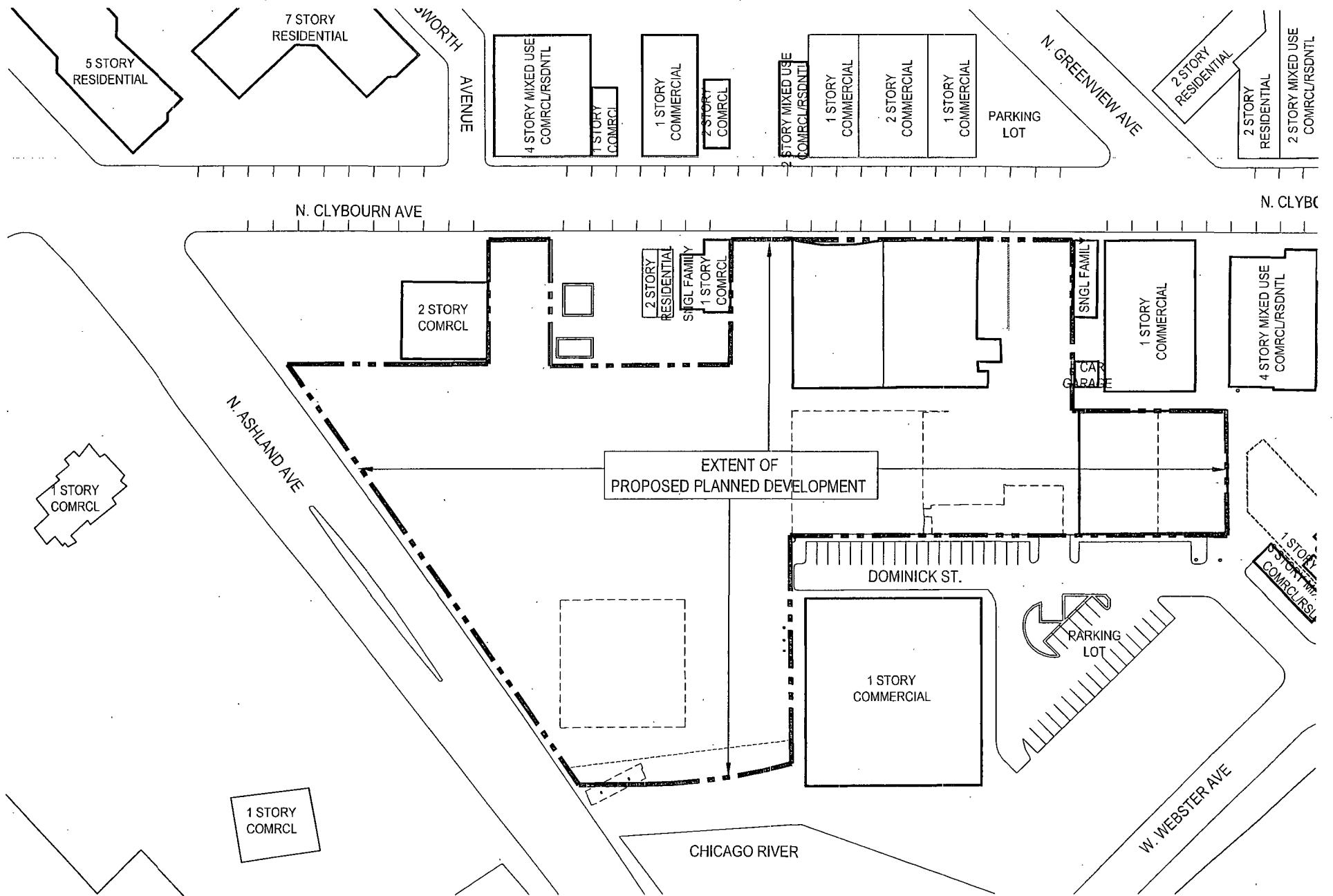

The Salvation Army Adult Rehabilitation Center - Planned Development

2258 N. Clybourn Avenue, Chicago, IL 60614

Antunovich Associates, Architects & Planners

D. Existing Land-Use Map

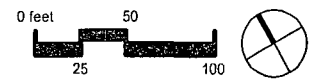

July 06, 2011

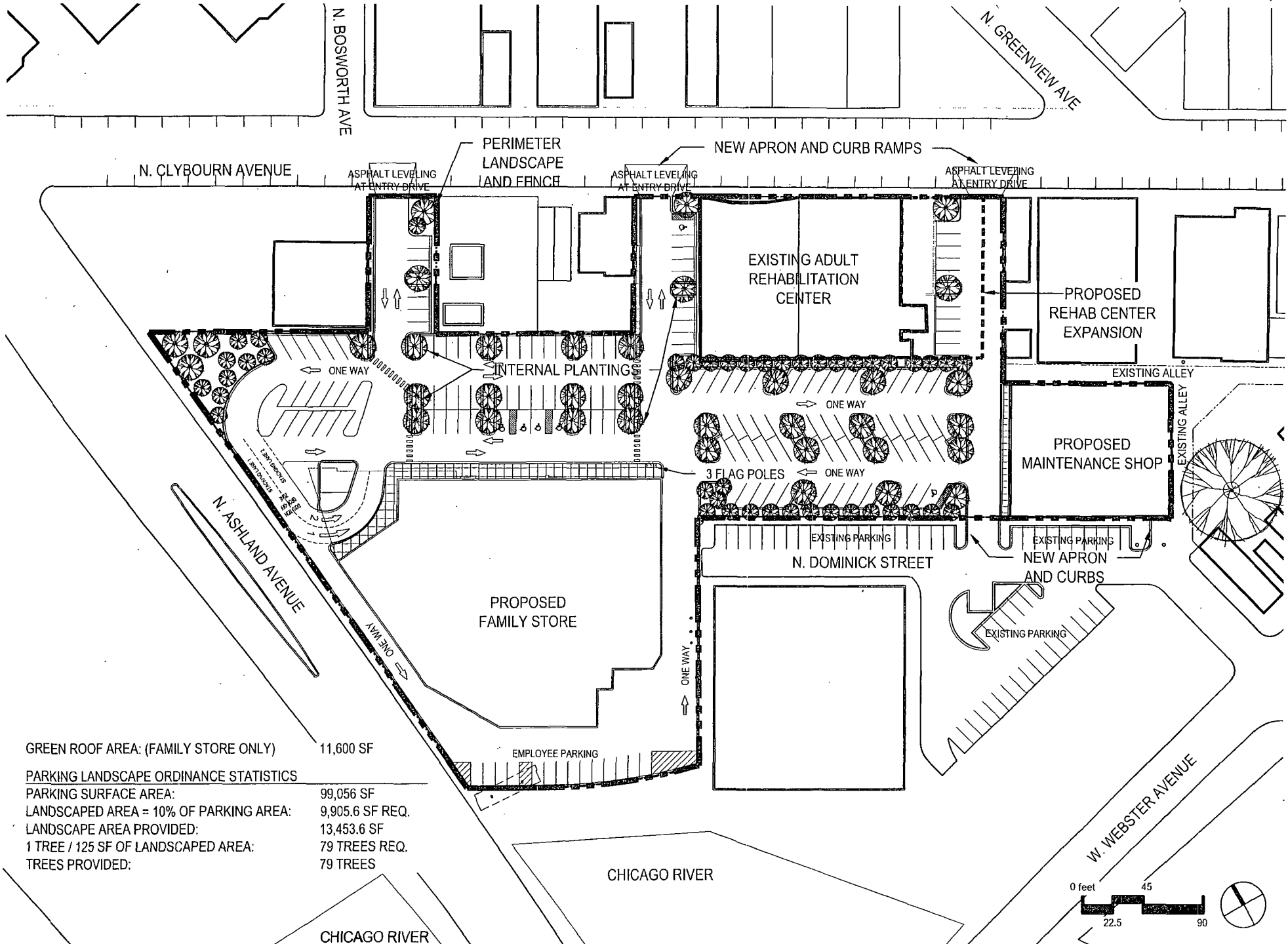

GREEN ROOF AREA: (FAMILY STORE ONLY)	11,600 SF
PARKING LANDSCAPE ORDINANCE STATISTICS	
PARKING SURFACE AREA:	99,056 SF
LANDSCAPED AREA = 10% OF PARKING AREA:	9,905.6 SF REQ.
LANDSCAPE AREA PROVIDED:	13,453.6 SF
1 TREE / 125 SF OF LANDSCAPED AREA:	79 TREES REQ.
TREES PROVIDED:	79 TREES

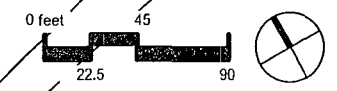

The Salvation Army Adult Rehabilitation Center - Planned Development

E. Masterplan and Landscape Plan

2258 N. Clybourn Avenue, Chicago, IL 60614
 Antunovich Associates, Architects & Planners

July 06, 2011

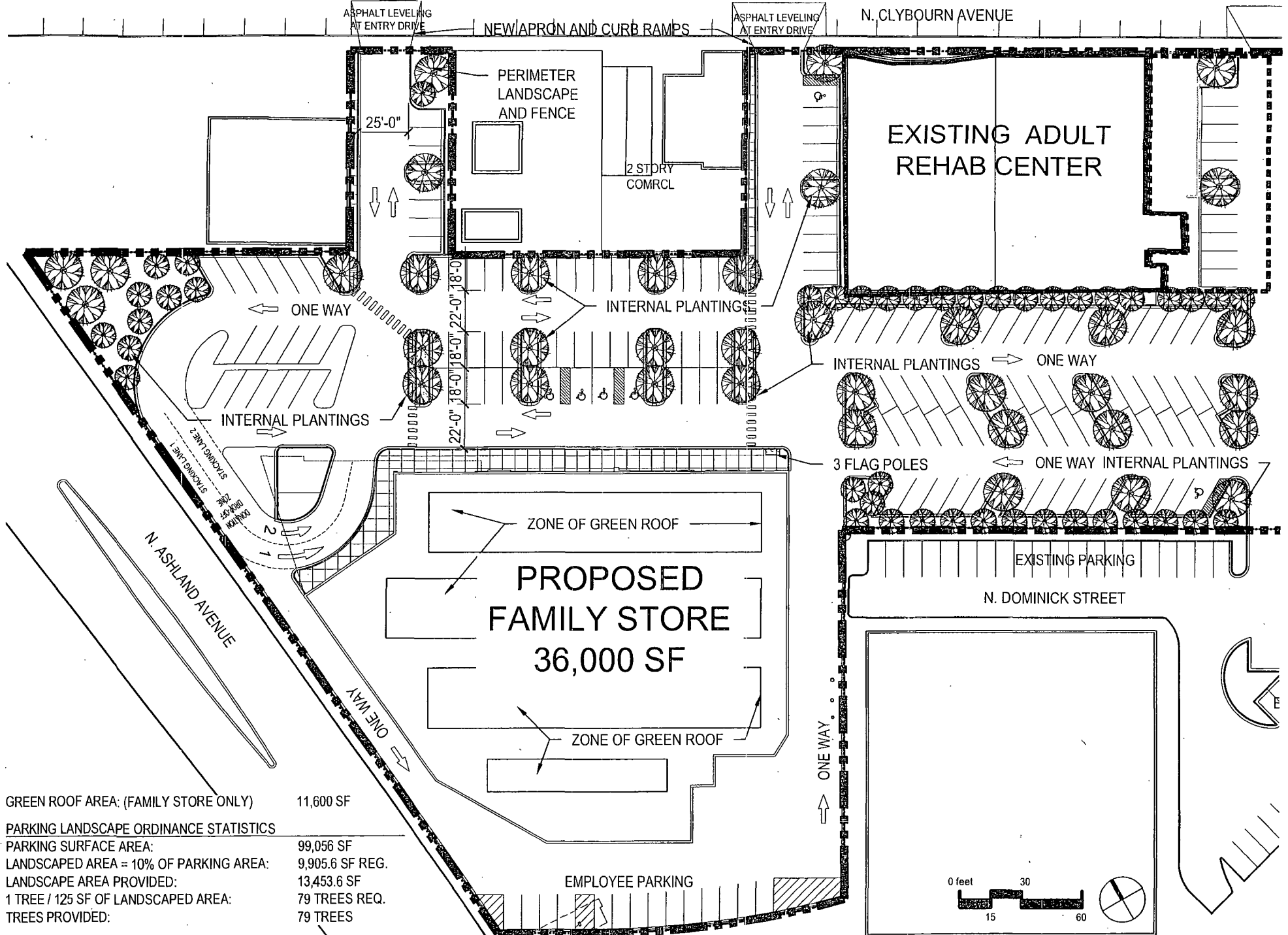

GREEN ROOF AREA: (FAMILY STORE ONLY)	11,600 SF
PARKING LANDSCAPE ORDINANCE STATISTICS	
PARKING SURFACE AREA:	99,056 SF
LANDSCAPED AREA = 10% OF PARKING AREA:	9,905.6 SF REG.
LANDSCAPE AREA PROVIDED:	13,453.6 SF
1 TREE / 125 SF OF LANDSCAPED AREA:	79 TREES REQ.
TREES PROVIDED:	79 TREES

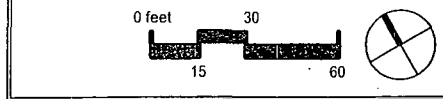

The Salvation Army Adult Rehabilitation Center - Planned Development

F1. Family Store Site Plan

2258 N. Clybourn Avenue, Chicago, IL 60614

July 06, 2011

Antunovich Associates, Architects & Planners

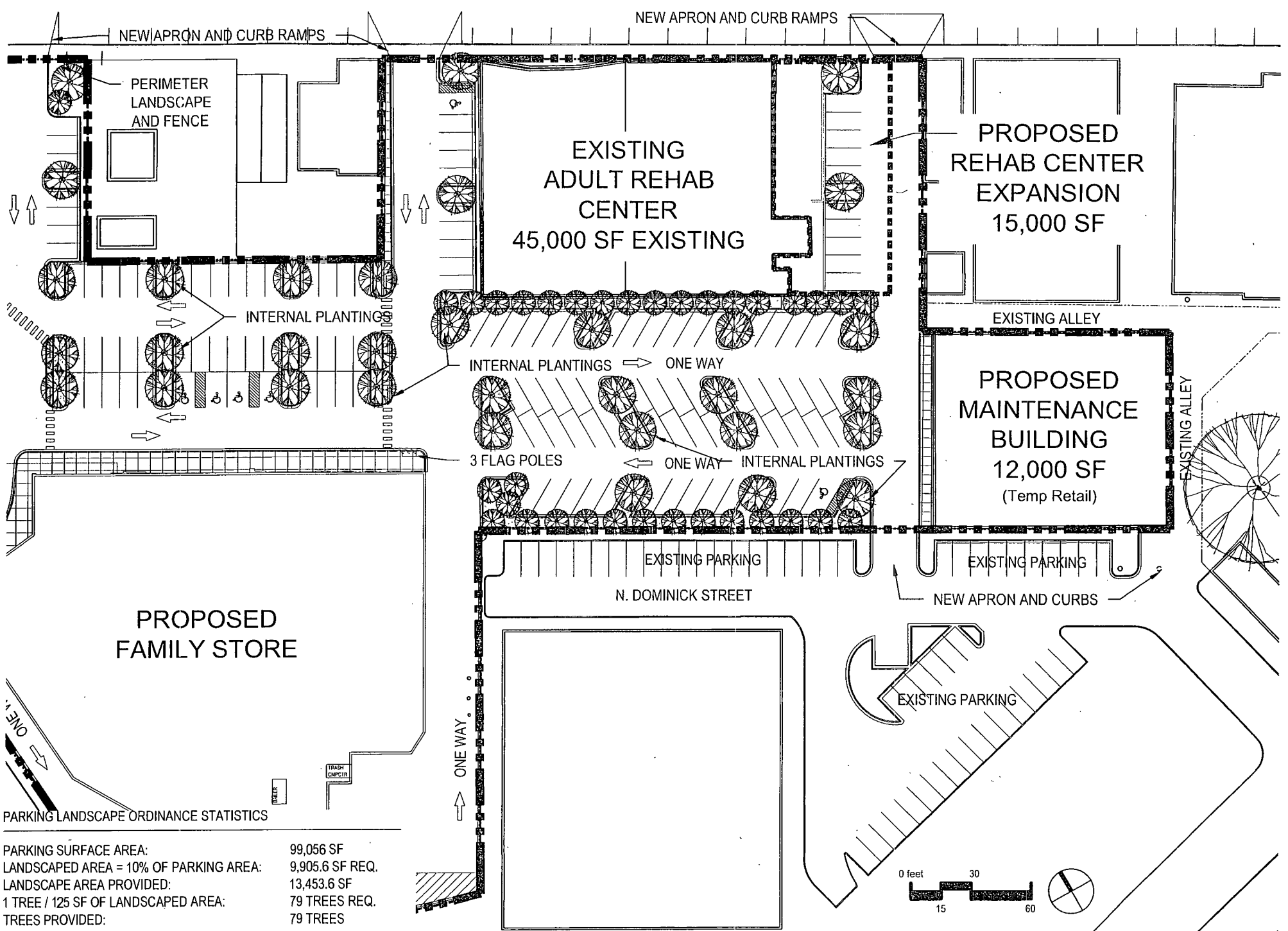

PARKING LANDSCAPE ORDINANCE STATISTICS

PARKING SURFACE AREA:	99,056 SF
LANDSCAPED AREA = 10% OF PARKING AREA:	9,905.6 SF REQ.
LANDSCAPE AREA PROVIDED:	13,453.6 SF
1 TREE / 125 SF OF LANDSCAPED AREA:	79 TREES REQ.
TREES PROVIDED:	79 TREES

The Salvation Army Adult Rehabilitation Center - Planned Development

2258 N. Clybourn Avenue, Chicago, IL 60614

Antunovich Associates, Architects & Planners

F2. Maintenance Building Site Plan

July 06, 2011

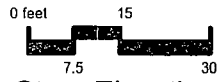
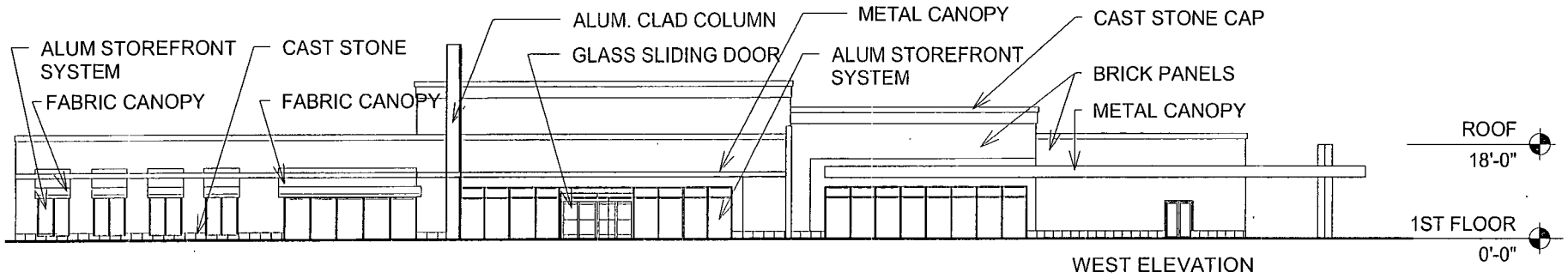
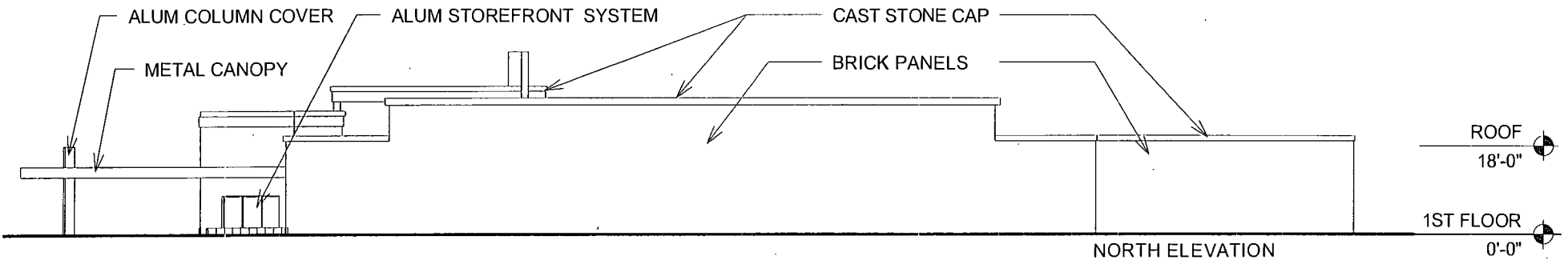
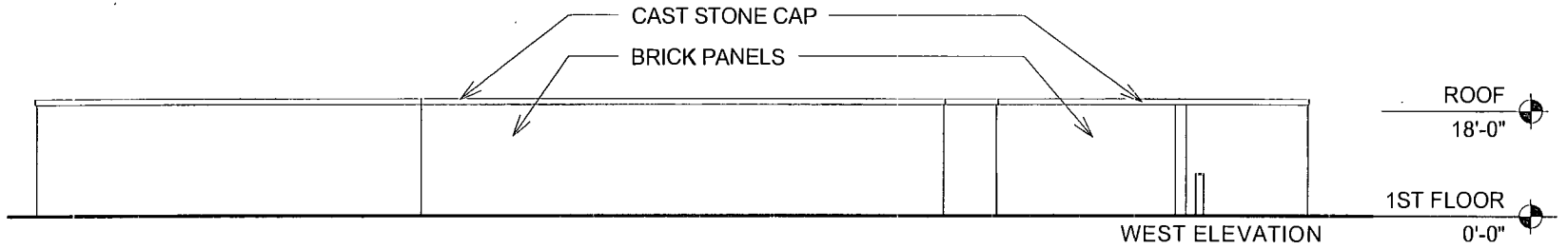
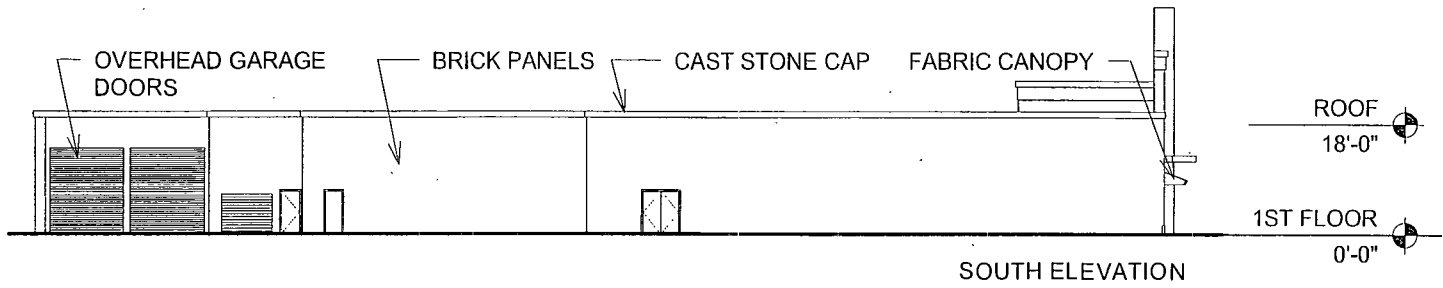

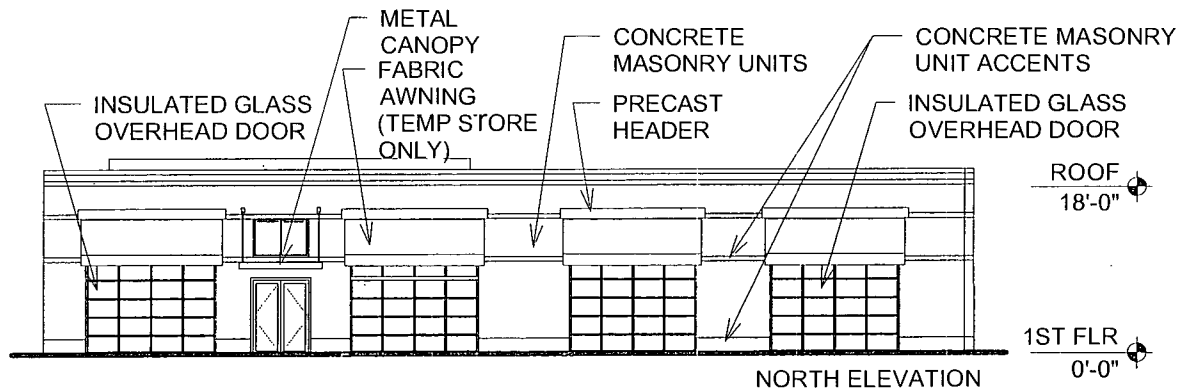
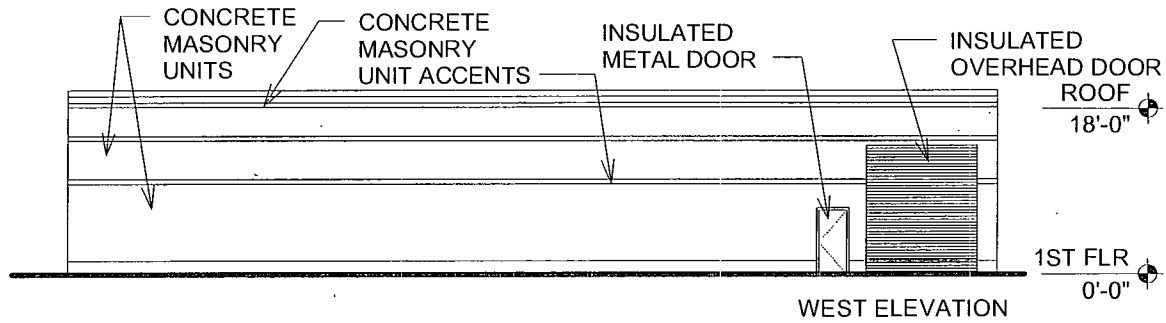
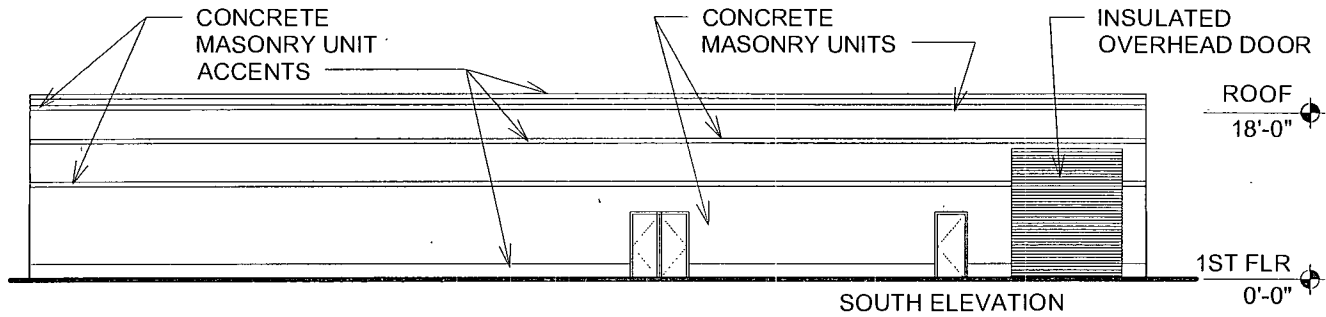
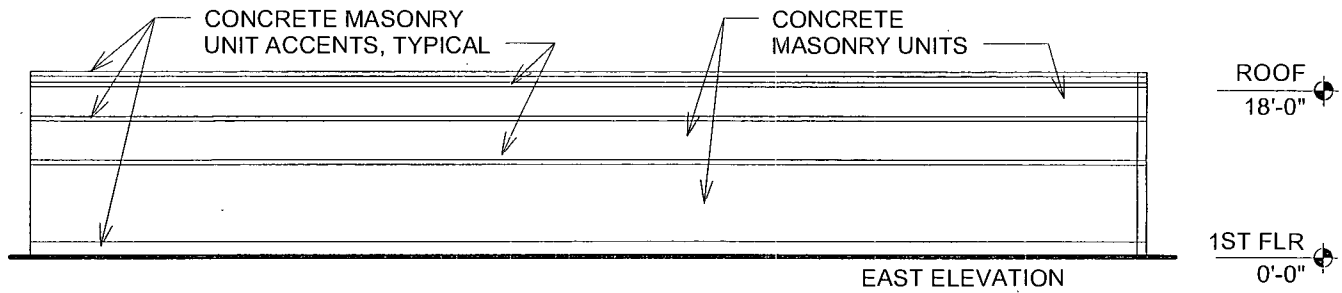

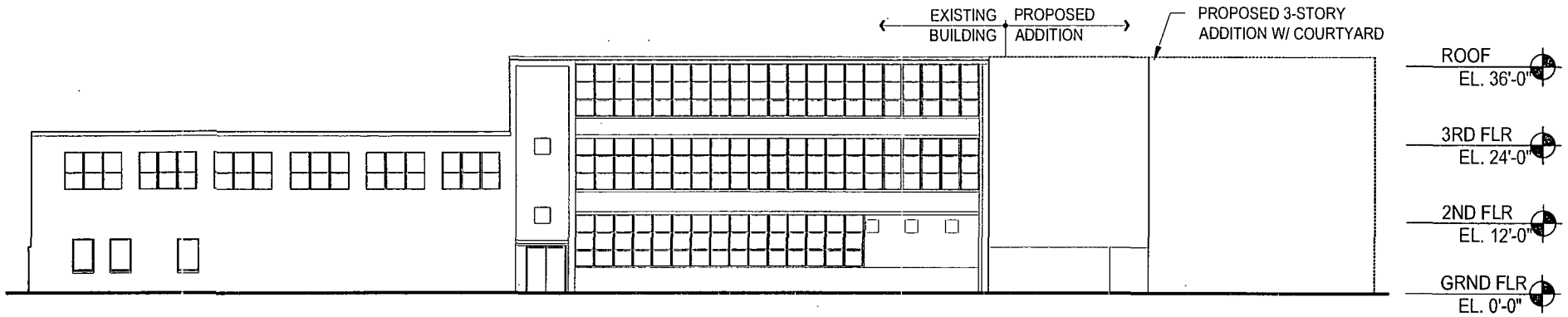

WEST ELEVATION

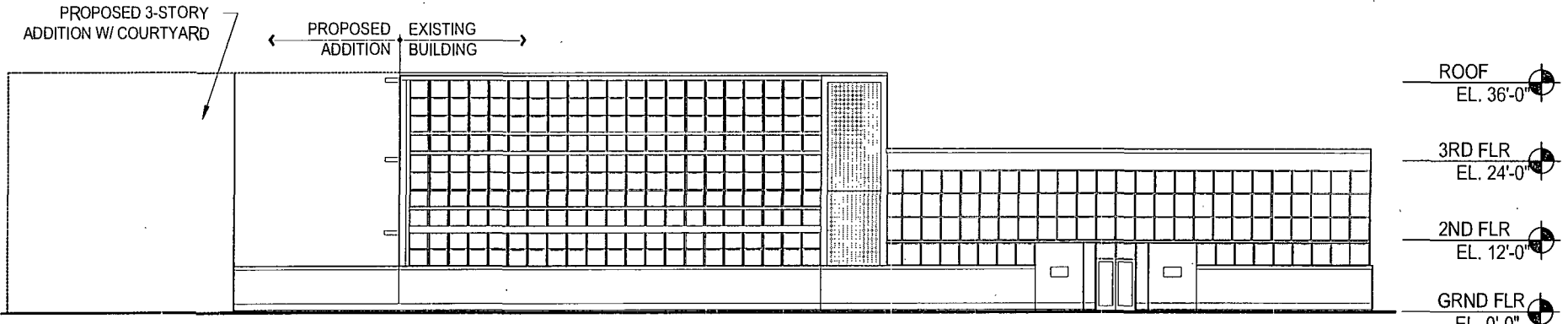

EAST ELEVATION

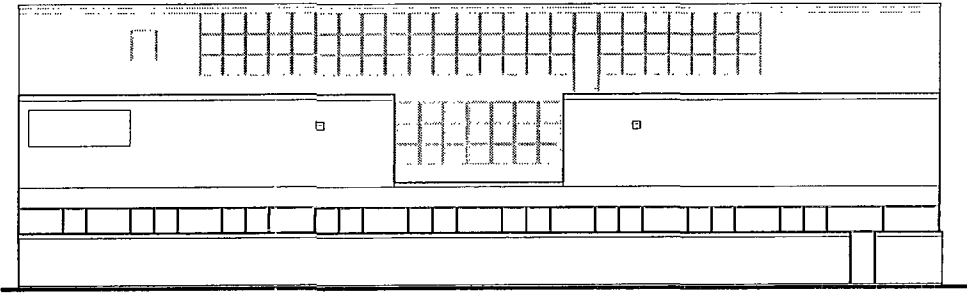

NORTH ELEVATION

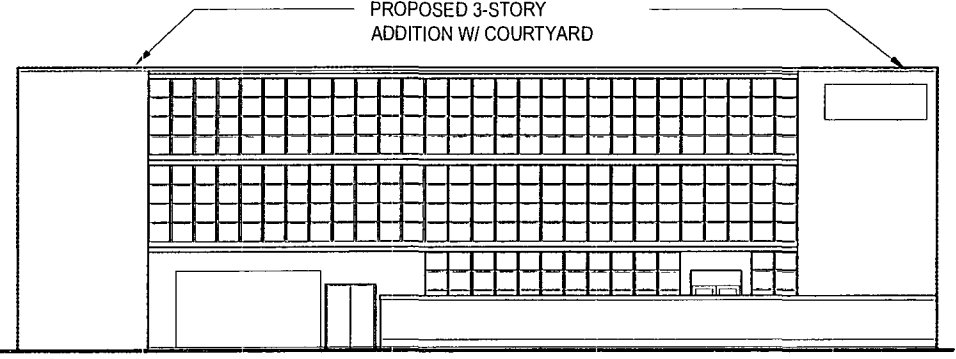

SOUTH ELEVATION

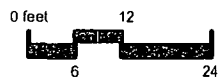

Written Notice, Form of Affidavit: Section 17-13-0107

June 27, 2011

Honorable Daniel Solis
Chairman, Committee on Zoning
121 North LaSalle Street
Room 304 - City Hall
Chicago, Illinois 60602

To Whom It May Concern:

The undersigned, **Sylvia C. Michas**, being first duly sworn on oath, deposes and says the following:

That the undersigned certifies that she has complied with the requirements of Section 17-13-0107 of the Zoning Code of the City of Chicago, by sending written notice to such property owners who appear to be the owners of the property within the subject area not solely owned by the applicant, and on the owners of all property within 250 feet in each direction of the lot line of the subject property, exclusive of the public roads, streets, alleys and other public ways, or a total distance limited to 400 feet. Said written notice was or will be sent by USPS First Class Mail no more than 30 days before filing the application.

The undersigned certifies that the notice contained the address of the property sought to be rezoned as **2258 North Clybourn Chicago, IL**; a statement of intended use of said property; the name and address of the applicant; the name and address of the owner; and a statement that the applicant intends to file an application for a change in zoning on approximately **June 27, 2011**.

The applicant has made a bonafide effort to determine the addresses of the parties to be notified under Section 17-13-0107 of the Zoning Code of the City of Chicago; that the applicant certifies that the accompanying list of names and addresses of surrounding property owners within 250 feet is a complete list containing the names and last known addresses of the owners of the property required to be served.

Law Offices of Samuel V.P. Banks

By: **Sylvia C. Michas** Attorney

Subscribed and Sworn to before me
this 27 day of JUNE, 2011

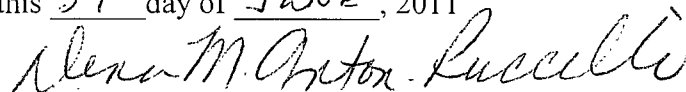



NOTICE

Via USPS First Class Mail

June 27, 2011

Dear Sir or Madam:

In accordance with Amendment to the Zoning Code enacted by the City Council, Section 17-13-0107-A, please be informed that on or about **June 27, 2011, I, the undersigned, filed an application for a change in zoning from a M1-2 Limited Manufacturing/Business Park District and M3-3 Heavy Industry District to a C2-2 Motor Vehicle-Related Commercial District then to an Institutional-Business Planned Development**, on behalf of the Applicant/Owner, The Salvation Army, an Illinois corporation for the property located at **2258 North Clybourn Chicago, IL.**

The Planned Development is required in order to a) construct a new family store containing 34,900 sq. ft, b) construct a new maintenance building containing 12,000 sq. ft.; c) permit the expansion of the adult rehabilitation center (14,934 sq. ft). The proposed height of the buildings included in the PD shall not exceed 36'. The Planned Development shall also include 145 on-site parking spaces.

The Salvation Army, an Illinois corporation is located at 10 W. Algonquin Rd. Des Plaines, IL

Please note that the applicant is not seeking to purchase or rezone your property. The applicant is required by law to send this notice because you own property located within 250 feet of the proposed amendment.

The contact person for this application is **Sylvia C. Michas**. My address is 221 N. LaSalle Street, Chicago, IL 60601. My telephone number is 312-782-1983.

Very truly yours,

LAW OFFICES OF SAMUEL V.P. BANKS

Sylvia C. Michas

FORM OF AFFIDAVIT

Chairman, Committee on Zoning
Room 304 - City Hall
Chicago, IL 60602

To Whom It May Concern:

I, Bramwell E. Higgins on behalf of The Salvation Army, an Illinois corporation, understand that the Law Office of Samuel V.P. Banks has filed a sworn affidavit identifying The Salvation Army, an Illinois corporation as Applicant/Owner holding interest in land subject to the proposed Institutional-Business Planned Development application for the property identified as 2258 North Clybourn Chicago, IL.

I, Bramwell E. Higgins, on behalf of The Salvation Army, an Illinois corporation, being first duly sworn oath, depose and say that The Salvation Army, an Illinois corporation, holds that interest for itself and no other person, association, or shareholder.

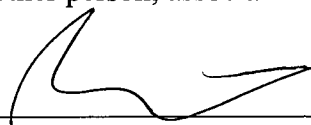

The Salvation Army, an Illinois corporation

By: Bramwell E. Higgins
Secretary

Subscribed and Sworn to before me
this 28th day of June, 2011

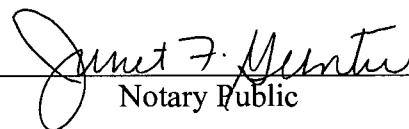

Notary Public



To whom it may concern:

I, Bramwell E. Higgins, on behalf of The Salvation Army, an Illinois corporation, Applicant/Owner of property located at 2258 North Clybourn Ave. Chicago, IL, authorize the Law Office of Samuel V.P. Banks, to file an Institutional-Business Planned Development Application with the City of Chicago for that property.

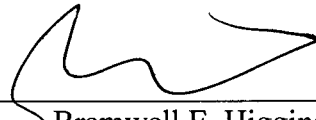

Bramwell E. Higgins

Secretary

CITY OF CHICAGO
ECONOMIC DISCLOSURE STATEMENT
AND AFFIDAVIT

SECTION I -- GENERAL INFORMATION

A. Legal name of the Disclosing Party submitting this EDS. Include d/b/a/ if applicable:

The Salvation Army, An Illinois corporation

Check ONE of the following three boxes:

Indicate whether the Disclosing Party submitting this EDS is:

1. the Applicant
OR

2. a legal entity holding a direct or indirect interest in the Applicant. State the legal name of the Applicant in which the Disclosing Party holds an interest: _____
OR

3. a legal entity with a right of control (see Section II.B.1.) State the legal name of the entity in which the Disclosing Party holds a right of control: _____

B. Business address of the Disclosing Party: 10 W. Algonquin Rd.
Des Plaines, IL 60016

C. Telephone: 312-782-1983 Fax: 312-782-2433 Email: sylvia@sambankslaw.com

D. Name of contact person: Sylvia C. Michas, Attorney for Applicant

E. Federal Employer Identification No. (if you have one): _____

F. Brief description of contract, transaction or other undertaking (referred to below as the "Matter") to which this EDS pertains. (Include project number and location of property, if applicable):

Institutional-Business Planned Development application for the property located at
2258 North Clybourn Chicago, IL.

G. Which City agency or department is requesting this EDS? Department of Housing & Economic Development

If the Matter is a contract being handled by the City's Department of Procurement Services, please complete the following:

Specification # _____ and Contract # _____

SECTION II -- DISCLOSURE OF OWNERSHIP INTERESTS

A. NATURE OF THE DISCLOSING PARTY

1. Indicate the nature of the Disclosing Party:

- Person
- Publicly registered business corporation
- Privately held business corporation
- Sole proprietorship
- General partnership
- Limited partnership
- Trust
- Limited liability company
- Limited liability partnership
- Joint venture
- Not-for-profit corporation
(Is the not-for-profit corporation also a 501(c)(3))?
 Yes No
- Other (please specify)

2. For legal entities, the state (or foreign country) of incorporation or organization, if applicable:

Illinois

3. For legal entities not organized in the State of Illinois: Has the organization registered to do business in the State of Illinois as a foreign entity?

- Yes
- No
- N/A

B. IF THE DISCLOSING PARTY IS A LEGAL ENTITY:

1. List below the full names and titles of all executive officers and all directors of the entity.

NOTE: For not-for-profit corporations, also list below all members, if any, which are legal entities. If there are no such members, write "no members." For trusts, estates or other similar entities, list below the legal titleholder(s).

If the entity is a general partnership, limited partnership, limited liability company, limited liability partnership or joint venture, list below the name and title of each general partner, managing member, manager or any other person or entity that controls the day-to-day management of the Disclosing Party. NOTE: Each legal entity listed below must submit an EDS on its own behalf.

Name

Title

See attached for officers and directors

2. Please provide the following information concerning each person or entity having a direct or indirect beneficial interest (including ownership) in excess of 7.5% of the Disclosing Party. Examples of such an interest include shares in a corporation, partnership interest in a partnership or joint venture,

BOARD OF TRUSTEES

CHAIRMAN OF THE BOARD

WILLIAM A. ROBERTS

PRESIDENT

PAUL R. SEILER

VICE PRESIDENT

MERLE HEATWOLE

TREASURER

RICHARD AMICK

SECRETARY

BRAMWELL E. HIGGINS

ASSIST. TREASURER

E. RANDALL POLSLEY

ASSIST. SECRETARY

JEFFREY J. SMITH

TRUSTEE

RICHARD VANDER WEELE

TRUSTEE

JAMES HOSKIN

interest of a member or manager in a limited liability company, or interest of a beneficiary of a trust, estate or other similar entity. If none, state "None." NOTE: Pursuant to Section 2-154-030 of the Municipal Code of Chicago ("Municipal Code"), the City may require any such additional information from any applicant which is reasonably intended to achieve full disclosure.

Name	Business Address	Percentage Interest in the Disclosing Party
<i>None</i>		

SECTION III -- BUSINESS RELATIONSHIPS WITH CITY ELECTED OFFICIALS

Has the Disclosing Party had a "business relationship," as defined in Chapter 2-156 of the Municipal Code, with any City elected official in the 12 months before the date this EDS is signed?

Yes No

If yes, please identify below the name(s) of such City elected official(s) and describe such relationship(s):

SECTION IV -- DISCLOSURE OF SUBCONTRACTORS AND OTHER RETAINED PARTIES

The Disclosing Party must disclose the name and business address of each subcontractor, attorney, lobbyist, accountant, consultant and any other person or entity whom the Disclosing Party has retained or expects to retain in connection with the Matter, as well as the nature of the relationship, and the total amount of the fees paid or estimated to be paid. The Disclosing Party is not required to disclose employees who are paid solely through the Disclosing Party's regular payroll.

"Lobbyist" means any person or entity who undertakes to influence any legislative or administrative action on behalf of any person or entity other than: (1) a not-for-profit entity, on an unpaid basis, or (2) himself. "Lobbyist" also means any person or entity any part of whose duties as an employee of another includes undertaking to influence any legislative or administrative action.

If the Disclosing Party is uncertain whether a disclosure is required under this Section, the Disclosing Party must either ask the City whether disclosure is required or make the disclosure.

Name (indicate whether retained or anticipated to be retained)	Business Address	Relationship to Disclosing Party (subcontractor, attorney, lobbyist, etc.)	Fees (indicate whether paid or estimated.) NOTE: "hourly rate" or "t.b.d." is not an acceptable response.
<i>Law Offices of Samuel VP Banks</i>	<i>221 North LaSalle #3800</i>	<i>#3800 Chicago, IL 60601</i>	<i>\$10,000</i>

(Add sheets if necessary)

[] Check here if the Disclosing Party has not retained, nor expects to retain, any such persons or entities.

SECTION V -- CERTIFICATIONS

A. COURT-ORDERED CHILD SUPPORT COMPLIANCE

Under Municipal Code Section 2-92-415, substantial owners of business entities that contract with the City must remain in compliance with their child support obligations throughout the contract's term.

Has any person who directly or indirectly owns 10% or more of the Disclosing Party been declared in arrearage on any child support obligations by any Illinois court of competent jurisdiction?

[] Yes [] No No person directly or indirectly owns 10% or more of the Disclosing Party.

If "Yes," has the person entered into a court-approved agreement for payment of all support owed and is the person in compliance with that agreement?

[] Yes [] No

B. FURTHER CERTIFICATIONS

1. Pursuant to Municipal Code Chapter 1-23, Article I ("Article I")(which the Applicant should consult for defined terms (e.g., "doing business") and legal requirements), if the Disclosing Party submitting this EDS is the Applicant and is doing business with the City, then the Disclosing Party certifies as follows: (i) neither the Applicant nor any controlling person is currently indicted or charged with, or has admitted guilt of, or has ever been convicted of, or placed under supervision for, any criminal offense involving actual, attempted, or conspiracy to commit bribery, theft, fraud, forgery, perjury, dishonesty or deceit against an officer or employee of the City or any sister agency; and (ii) the Applicant understands and acknowledges that compliance with Article I is a continuing requirement for doing business with the City. NOTE: If Article I applies to the Applicant, the permanent compliance timeframe in Article I supersedes some five-year compliance timeframes in certifications 2 and 3 below.

2. The Disclosing Party and, if the Disclosing Party is a legal entity, all of those persons or entities identified in Section 11.B.1. of this EDS:

- a. are not presently debarred, suspended, proposed for debarment, declared ineligible or voluntarily excluded from any transactions by any federal, state or local unit of government;
- b. have not, within a five-year period preceding the date of this EDS, been convicted of a criminal offense, adjudged guilty, or had a civil judgment rendered against them in connection with: obtaining, attempting to obtain, or performing a public (federal, state or local) transaction or contract under a public transaction; a violation of federal or state antitrust statutes; fraud; embezzlement; theft; forgery; bribery; falsification or destruction of records; making false statements; or receiving stolen property;
- c. are not presently indicted for, or criminally or civilly charged by, a governmental entity (federal, state or local) with committing any of the offenses set forth in clause B.2.b. of this Section V;
- d. have not, within a five-year period preceding the date of this EDS, had one or more public transactions (federal, state or local) terminated for cause or default; and
- e. have not, within a five-year period preceding the date of this EDS, been convicted, adjudged guilty, or found liable in a civil proceeding, or in any criminal or civil action, including actions concerning environmental violations, instituted by the City or by the federal government, any state, or any other unit of local government.

3. The certifications in subparts 3, 4 and 5 concern:

- the Disclosing Party;
- any "Contractor" (meaning any contractor or subcontractor used by the Disclosing Party in connection with the Matter, including but not limited to all persons or legal entities disclosed under Section IV, "Disclosure of Subcontractors and Other Retained Parties");
- any "Affiliated Entity" (meaning a person or entity that, directly or indirectly: controls the Disclosing Party, is controlled by the Disclosing Party, or is, with the Disclosing Party, under common control of another person or entity. Indicia of control include, without limitation: interlocking management or ownership; identity of interests among family members, shared facilities and equipment; common use of employees; or organization of a business entity following the ineligibility of a business entity to do business with federal or state or local government, including the City, using substantially the same management, ownership, or principals as the ineligible entity); with respect to Contractors, the term Affiliated Entity means a person or entity that directly or indirectly controls the Contractor, is controlled by it, or, with the Contractor, is under common control of another person or entity;
- any responsible official of the Disclosing Party, any Contractor or any Affiliated Entity or any other official, agent or employee of the Disclosing Party, any Contractor or any Affiliated Entity, acting pursuant to the direction or authorization of a responsible official of the Disclosing Party, any Contractor or any Affiliated Entity (collectively "Agents").

Neither the Disclosing Party, nor any Contractor, nor any Affiliated Entity of either the Disclosing Party or any Contractor nor any Agents have, during the five years before the date this EDS is signed, or, with respect to a Contractor, an Affiliated Entity, or an Affiliated Entity of a Contractor during the five years before the date of such Contractor's or Affiliated Entity's contract or engagement in connection with the Matter:

- a. bribed or attempted to bribe, or been convicted or adjudged guilty of bribery or attempting to bribe, a public officer or employee of the City, the State of Illinois, or any agency of the federal government or of any state or local government in the United States of America, in that officer's or employee's official capacity;
- b. agreed or colluded with other bidders or prospective bidders, or been a party to any such agreement, or been convicted or adjudged guilty of agreement or collusion among bidders or prospective bidders, in restraint of freedom of competition by agreement to bid a fixed price or otherwise; or
- c. made an admission of such conduct described in a. or b. above that is a matter of record, but have not been prosecuted for such conduct; or
- d. violated the provisions of Municipal Code Section 2-92-610 (Living Wage Ordinance).

4. Neither the Disclosing Party, Affiliated Entity or Contractor, or any of their employees, officials, agents or partners, is barred from contracting with any unit of state or local government as a result of engaging in or being convicted of (1) bid-rigging in violation of 720 ILCS 5/33E-3; (2) bid-rotating in violation of 720 ILCS 5/33E-4; or (3) any similar offense of any state or of the United States of America that contains the same elements as the offense of bid-rigging or bid-rotating.

5. Neither the Disclosing Party nor any Affiliated Entity is listed on any of the following lists maintained by the Office of Foreign Assets Control of the U.S. Department of the Treasury or the Bureau of Industry and Security of the U.S. Department of Commerce or their successors: the Specially Designated Nationals List, the Denied Persons List, the Unverified List, the Entity List and the Debarred List.

6. The Disclosing Party understands and shall comply with the applicable requirements of Chapters 2-55 (Legislative Inspector General), 2-56 (Inspector General) and 2-156 (Governmental Ethics) of the Municipal Code.

7. If the Disclosing Party is unable to certify to any of the above statements in this Part B (Further Certifications), the Disclosing Party must explain below:

If the letters "NA," the word "None," or no response appears on the lines above, it will be conclusively presumed that the Disclosing Party certified to the above statements.

C. CERTIFICATION OF STATUS AS FINANCIAL INSTITUTION

1. The Disclosing Party certifies that the Disclosing Party (check one)

is is not

a "financial institution" as defined in Section 2-32-455(b) of the Municipal Code.

2. If the Disclosing Party IS a financial institution, then the Disclosing Party pledges:

"We are not and will not become a predatory lender as defined in Chapter 2-32 of the Municipal Code. We further pledge that none of our affiliates is, and none of them will become, a predatory lender as defined in Chapter 2-32 of the Municipal Code. We understand that becoming a predatory lender or becoming an affiliate of a predatory lender may result in the loss of the privilege of doing business with the City."

If the Disclosing Party is unable to make this pledge because it or any of its affiliates (as defined in Section 2-32-455(b) of the Municipal Code) is a predatory lender within the meaning of Chapter 2-32 of the Municipal Code, explain here (attach additional pages if necessary):

If the letters "NA," the word "None," or no response appears on the lines above, it will be conclusively presumed that the Disclosing Party certified to the above statements.

D. CERTIFICATION REGARDING INTEREST IN CITY BUSINESS

Any words or terms that are defined in Chapter 2-156 of the Municipal Code have the same meanings when used in this Part D.

1. In accordance with Section 2-156-110 of the Municipal Code: Does any official or employee of the City have a financial interest in his or her own name or in the name of any other person or entity in the Matter?

Yes No

NOTE: If you checked "Yes" to Item D.1., proceed to Items D.2. and D.3. If you checked "No" to Item D.1., proceed to Part E.

2. Unless sold pursuant to a process of competitive bidding, or otherwise permitted, no City elected official or employee shall have a financial interest in his or her own name or in the name of any other person or entity in the purchase of any property that (i) belongs to the City, or (ii) is sold for taxes or assessments, or (iii) is sold by virtue of legal process at the suit of the City (collectively, "City Property Sale"). Compensation for property taken pursuant to the City's eminent domain power does not constitute a financial interest within the meaning of this Part D.

Does the Matter involve a City Property Sale?

Yes

No

3. If you checked "Yes" to Item D.L, provide the names and business addresses of the City officials or employees having such interest and identify the nature of such interest:

Name	Business Address	Nature of Interest

4. The Disclosing Party further certifies that no prohibited financial interest in the Matter will be acquired by any City official or employee.

E. CERTIFICATION REGARDING SLAVERY ERA BUSINESS

Please check either 1. or 2. below. If the Disclosing Party checks 2., the Disclosing Party must disclose below or in an attachment to this EDS all information required by paragraph 2. Failure to comply with these disclosure requirements may make any contract entered into with the City in connection with the Matter voidable by the City.

 x 1. The Disclosing Party verifies that the Disclosing Party has searched any and all records of the Disclosing Party and any and all predecessor entities regarding records of investments or profits from slavery or slaveholder insurance policies during the slavery era (including insurance policies issued to slaveholders that provided coverage for damage to or injury or death of their slaves), and the Disclosing Party has found no such records.

 2. The Disclosing Party verifies that, as a result of conducting the search in step 1 above, the Disclosing Party has found records of investments or profits from slavery or slaveholder insurance policies. The Disclosing Party verifies that the following constitutes full disclosure of all such records, including the names of any and all slaves or slaveholders described in those records:

SECTION VI -- CERTIFICATIONS FOR FEDERALLY FUNDED MATTERS

NOTE: If the Matter is federally funded, complete this Section VI. If the Matter is not federally funded, proceed to Section VII. For purposes of this Section VI, tax credits allocated by the City and proceeds of debt obligations of the City are not federal funding.

A. CERTIFICATION REGARDING LOBBYING

1. List below the names of all persons or entities registered under the federal Lobbying Disclosure Act of 1995 who have made lobbying contacts on behalf of the Disclosing Party with respect to the Matter: (Add sheets if necessary):

(If no explanation appears or begins on the lines above, or if the letters "NA" or if the word "None" appear, it will be conclusively presumed that the Disclosing Party means that NO persons or entities registered under the Lobbying Disclosure Act of 1995 have made lobbying contacts on behalf of the Disclosing Party with respect to the Matter.)

2. The Disclosing Party has not spent and will not expend any federally appropriated funds to pay any person or entity listed in Paragraph A.1. above for his or her lobbying activities or to pay any person or entity to influence or attempt to influence an officer or employee of any agency, as defined by applicable federal law, a member of Congress, an officer or employee of Congress, or an employee of a member of Congress, in connection with the award of any federally funded contract, making any federally funded grant or loan, entering into any cooperative agreement, or to extend, continue, renew, amend, or modify any federally funded contract, grant, loan, or cooperative agreement.

3. The Disclosing Party will submit an updated certification at the end of each calendar quarter in which there occurs any event that materially affects the accuracy of the statements and information set forth in paragraphs A.1. and A.2. above.

4. The Disclosing Party certifies that either: (i) it is not an organization described in section 501(c)(4) of the Internal Revenue Code of 1986; or (ii) it is an organization described in section 501(c)(4) of the Internal Revenue Code of 1986 but has not engaged and will not engage in "Lobbying Activities".

5. If the Disclosing Party is the Applicant, the Disclosing Party must obtain certifications equal in form and substance to paragraphs A.1. through A.4. above from all subcontractors before it awards any subcontract and the Disclosing Party must maintain all such subcontractors' certifications for the duration of the Matter and must make such certifications promptly available to the City upon request.

B. CERTIFICATION REGARDING EQUAL EMPLOYMENT OPPORTUNITY

If the Matter is federally funded, federal regulations require the Applicant and all proposed subcontractors to submit the following information with their bids or in writing at the outset of negotiations.

Is the Disclosing Party the Applicant?

Yes No

If "Yes," answer the three questions below:

1. Have you developed and do you have on file affirmative action programs pursuant to applicable federal regulations? (See 41 CFR Part 60-2.)

Yes No

2. Have you filed with the Joint Reporting Committee, the Director of the Office of Federal Contract Compliance Programs, or the Equal Employment Opportunity Commission all reports due under the applicable filing requirements?

Yes No

3. Have you participated in any previous contracts or subcontracts subject to the equal opportunity clause?

Yes No

If you checked "No" to question 1. or 2. above, please provide an explanation:

SECTION VII -- ACKNOWLEDGMENTS, CONTRACT INCORPORATION, COMPLIANCE, PENALTIES, DISCLOSURE

The Disclosing Party understands and agrees that:

A. The certifications, disclosures, and acknowledgments contained in this EDS will become part of any contract or other agreement between the Applicant and the City in connection with the Matter, whether procurement, City assistance, or other City action, and are material inducements to the City's execution of any contract or taking other action with respect to the Matter. The Disclosing Party understands that it must comply with all statutes, ordinances, and regulations on which this EDS is based.

B. The City's Governmental Ethics and Campaign Financing Ordinances, Chapters 2-156 and 2-164 of the Municipal Code, impose certain duties and obligations on persons or entities seeking City contracts, work, business, or transactions. The full text of these ordinances and a training program is available on line at www.cityofchicago.org/Ethics, and may also be obtained from the City's Board of Ethics, 740 N.

Sedgwick St., Suite 500, Chicago, IL 60610, (312) 744-9660. The Disclosing Party must comply fully with the applicable ordinances.

C. If the City determines that any information provided in this EDS is false, incomplete or inaccurate, any contract or other agreement in connection with which it is submitted may be rescinded or be void or voidable, and the City may pursue any remedies under the contract or agreement (if not rescinded or void), at law, or in equity, including terminating the Disclosing Party's participation in the Matter and/or declining to allow the Disclosing Party to participate in other transactions with the City. Remedies at law for a false statement of material fact may include incarceration and an award to the City of treble damages.

D. It is the City's policy to make this document available to the public on its Internet site and/or upon request. Some or all of the information provided on this EDS and any attachments to this EDS may be made available to the public on the Internet, in response to a Freedom of Information Act request, or otherwise. By completing and signing this EDS, the Disclosing Party waives and releases any possible rights or claims which it may have against the City in connection with the public release of information contained in this EDS and also authorizes the City to verify the accuracy of any information submitted in this EDS.

E. The information provided in this EDS must be kept current. In the event of changes, the Disclosing Party must supplement this EDS up to the time the City takes action on the Matter. If the Matter is a contract being handled by the City's Department of Procurement Services, the Disclosing Party must update this EDS as the contract requires. **NOTE:** With respect to Matters subject to Article I of Chapter 1-23 of the Municipal Code (imposing **PERMANENT INELIGIBILITY** for certain specified offenses), the information provided herein regarding eligibility must be kept current for a longer period, as required by Chapter 1-23 and Section 2-154-020 of the Municipal Code.

The Disclosing Party represents and warrants that:

F.1. The Disclosing Party is not delinquent in the payment of any tax administered by the Illinois Department of Revenue, nor are the Disclosing Party or its Affiliated Entities delinquent in paying any fine, fee, tax or other charge owed to the City. This includes, but is not limited to, all water charges, sewer charges, license fees, parking tickets, property taxes or sales taxes.

F.2 If the Disclosing Party is the Applicant, the Disclosing Party and its Affiliated Entities will not use, nor permit their subcontractors to use, any facility listed by the U.S. E.P.A. on the federal Excluded Parties List System ("EPLS") maintained by the U. S. General Services Administration.

F.3 If the Disclosing Party is the Applicant, the Disclosing Party will obtain from any contractors/subcontractors hired or to be hired in connection with the Matter certifications equal in form and substance to those in F.1. and F.2. above and will not, without the prior written consent of the City, use any such contractor/subcontractor that does not provide such certifications or that the Disclosing Party has reason to believe has not provided or cannot provide truthful certifications.

NOTE: If the Disclosing Party cannot certify as to any of the items in F.1., F.2. or F.3. above, an explanatory statement must be attached to this EDS.

CERTIFICATION

Under penalty of perjury, the person signing below: (1) warrants that he/she is authorized to execute this EDS and Appendix A (if applicable) on behalf of the Disclosing Party, and (2) warrants that all certifications and statements contained in this EDS and Appendix A (if applicable) are true, accurate and complete as of the date furnished to the City.

The Salvation Army, an Illinois corporation

(Print or type name of Disclosing Party)

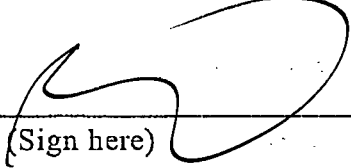
By: 
(Sign here)

Bramwell E. Higgins

(Print or type name of person signing)

Secretary

(Print or type title of person signing)

Signed and sworn to before me on (date) June 27, 2011,
at Cook County, IL (state).

 Notary Public.
Janet F. Gunter
Commission expires: 11/16/14.



**CITY OF CHICAGO
ECONOMIC DISCLOSURE STATEMENT AND AFFIDAVIT
APPENDIX A**

FAMILIAL RELATIONSHIPS WITH ELECTED CITY OFFICIALS AND DEPARTMENT HEADS

This Appendix is to be completed only by (a) the Applicant, and (b) any legal entity which has a direct ownership interest in the Applicant exceeding 7.5 percent. It is not to be completed by any legal entity which has only an indirect ownership interest in the Applicant.

Under Municipal Code Section 2-154-015, the Disclosing Party must disclose whether such Disclosing Party or any "Applicable Party" or any Spouse or Domestic Partner thereof currently has a "familial relationship" with any elected city official or department head. A "familial relationship" exists if, as of the date this EDS is signed, the Disclosing Party or any "Applicable Party" or any Spouse or Domestic Partner thereof is related to the mayor, any alderman, the city clerk, the city treasurer or any city department head as spouse or domestic partner or as any of the following, whether by blood or adoption: parent, child, brother or sister, aunt or uncle, niece or nephew, grandparent, grandchild, father-in-law, mother-in-law, son-in-law, daughter-in-law, stepfather or stepmother, stepson or stepdaughter, stepbrother or stepsister or half-brother or half-sister.

"Applicable Party" means (1) all executive officers of the Disclosing Party listed in Section II.B.1.a., if the Disclosing Party is a corporation; all partners of the Disclosing Party, if the Disclosing Party is a general partnership; all general partners and limited partners of the Disclosing Party, if the Disclosing Party is a limited partnership; all managers, managing members and members of the Disclosing Party, if the Disclosing Party is a limited liability company; (2) all principal officers of the Disclosing Party; and (3) any person having more than a 7.5 percent ownership interest in the Disclosing Party. "Principal officers" means the president, chief operating officer, executive director, chief financial officer, treasurer or secretary of a legal entity or any person exercising similar authority.

Does the Disclosing Party or any "Applicable Party" or any Spouse or Domestic Partner thereof currently have a "familial relationship" with an elected city official or department head?

Yes

No

If yes, please identify below (1) the name and title of such person, (2) the name of the legal entity to which such person is connected; (3) the name and title of the elected city official or department head to whom such person has a familial relationship, and (4) the precise nature of such familial relationship.
