



# City of Chicago



O2016-6367

Office of the City Clerk

## Document Tracking Sheet

<b>Meeting Date:</b>	9/14/2016
<b>Sponsor(s):</b>	Misc. Transmittal
<b>Type:</b>	Ordinance
<b>Title:</b>	Zoning Reclassification Map No. 7-N at 2601-2619 N Harlem Ave - App No. 18970T1
<b>Committee(s) Assignment:</b>	Committee on Zoning, Landmarks and Building Standards

# 1897071  
INTRO DATE:  
9-14-16

**ORDINANCE**

***BE IT ORDAINED BY THE CITY COUNCIL OF THE CITY OF CHICAGO:***

***SECTION 1.*** Title 17 of the Municipal Code of Chicago, the Chicago Zoning Ordinance, is hereby amended by changing all the B1-1 Neighborhood Shopping District and M1-1 Limited Manufacturing/Business Park District symbols and indications as shown on Map No.7-N in the area bounded by

a line 196 feet north of and parallel to West Wrightwood Avenue;  
the alley next east of and parallel to North Harlem Avenue; West  
Wrightwood Avenue; and North Harlem Avenue (City Limits),

to those of a B2-2 Neighborhood Mixed-Use District and a corresponding uses district is hereby established in the area above described.

***SECTION 2.*** This ordinance shall be in force and effect from and after its passage and due publication.

Common Address of Property: 2601-2619 North Harlem Avenue

**17-13-0303-C (1) Narrative Zoning Analysis – 2601-2619 N. Harlem Ave.**

Proposed Zoning: B2-2

Lot Area: 24,523.75 square feet

Proposed Land Use: The subject property will be divided into four (4) new zoning lots. Each resulting zoning lot will be developed with a new three-story building that will contain six (6) residential units. Onsite parking for six (6) cars will be located at the rear of each new zoning lot. Each building will be 35 feet 4 inches in height. Each building will be masonry construction.

- (a) The Project's floor area ratio:
  - 2601-03 N. Harlem: 1.36 (8,181 square feet on a 6,002 square foot lot)
  - 2607-09 N. Harlem: 1.33 (8,181 square feet on a 6,173 square foot lot)
  - 2611-13 N. Harlem: 1.33 (8,181 square feet on a 6,173 square foot lot)
  - 2615-19 N. Harlem: 1.33 (8,181 square feet on a 6,173 square foot lot)
  
- (b) The project's density:
  - 2601-03 N. Harlem: 6 units
  - 2607-09 N. Harlem: 6 units
  - 2611-13 N. Harlem: 6 units
  - 2615-19 N. Harlem: 6 units
  
- (c) The amount of off-street parking:
  - 2601-03 N. Harlem: 6 parking spaces
  - 2607-09 N. Harlem: 6 parking spaces
  - 2611-13 N. Harlem: 6 parking spaces
  - 2615-19 N. Harlem: 6 parking spaces
  
- (d) Setbacks:
  - a. Front Setbacks:
    - 2601-03 N. Harlem: 9 feet 10 inches
    - 2607-09 N. Harlem: 9 feet 10 inches
    - 2611-13 N. Harlem: 9 feet 10 inches
    - 2615-19 N. Harlem: 9 feet 10 inches
  
  - b. Rear Setbacks:
    - 2601-03 N. Harlem: 48 feet 10 inches
    - 2607-09 N. Harlem: 48 feet 10 inches
    - 2611-13 N. Harlem: 48 feet 10 inches
    - 2615-19 N. Harlem: 48 feet 10 inches
  
  - c. Side Setbacks:
    - 2601-03 N. Harlem: 3 feet north side / 1 foot 7 inches south side
    - 2607-09 N. Harlem: 3 feet north side / 3 feet south side
    - 2611-13 N. Harlem: 3 feet north side / 3 feet south side
    - 2615-19 N. Harlem: 3 feet north side / 3 feet south side

d. Rear Yard Open Space:

2601-03 N. Harlem: 0 square feet provided – Applicant will seek a Variation

2607-09 N. Harlem: 0 square feet provided – Applicant will seek a Variation

2611-13 N. Harlem: 0 square feet provided – Applicant will seek a Variation

2615-19 N. Harlem: 0 square feet provided – Applicant will seek a Variation

(e) Building Height:

2601-03 N. Harlem: 30 feet 6 inches

2607-09 N. Harlem: 30 feet 6 inches

2611-13 N. Harlem: 30 feet 6 inches

2615-19 N. Harlem: 30 feet 6 inches

\*17-10-0207-A and \*17-13-0303-C(2) – Plans Attached.

# 2601-03 N. Harlem Avenue, Chicago II.

N. HARLEM AVENUE

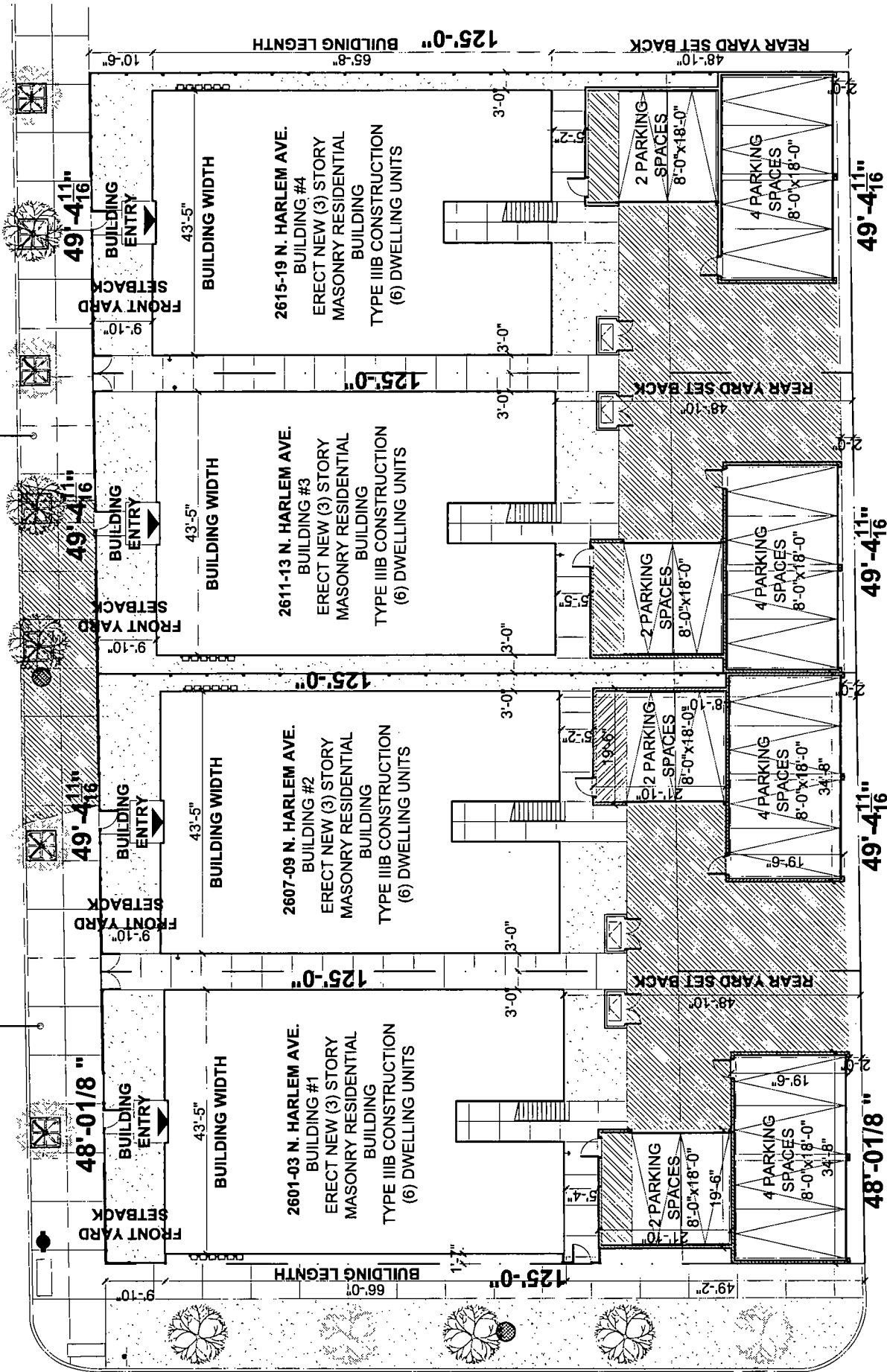

W. WRIGHTWOOD AVENUE



X I O S ARCHITECTS AND CONSULTANTS LTD.  
 501 S. WEST  
 CHICAGO, ILLINOIS 60606  
 TEL. 312.748.1332  
 FAX. 312.748.1332

1 SITE PLAN  
 Scale: N.T.S.



JUNE 8, 2018

# 2601-03 N. Harlem Avenue, Chicago II.

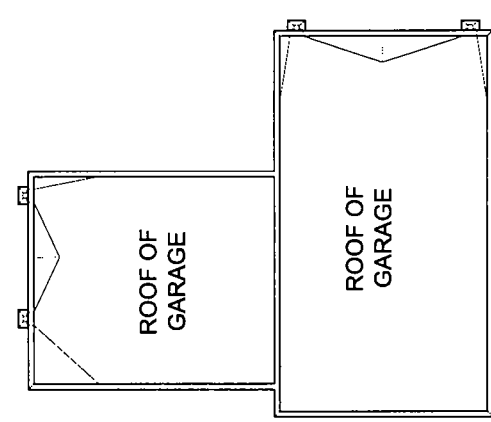
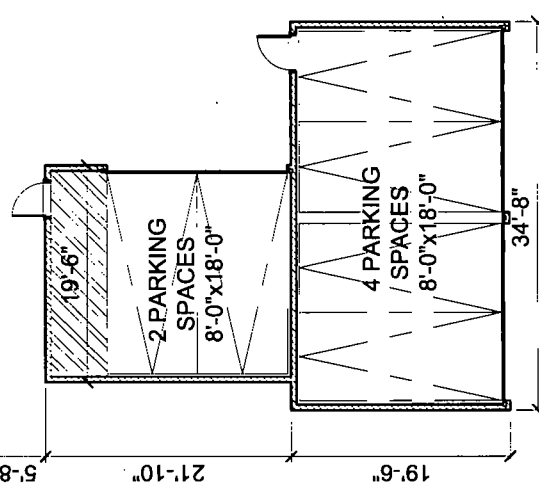
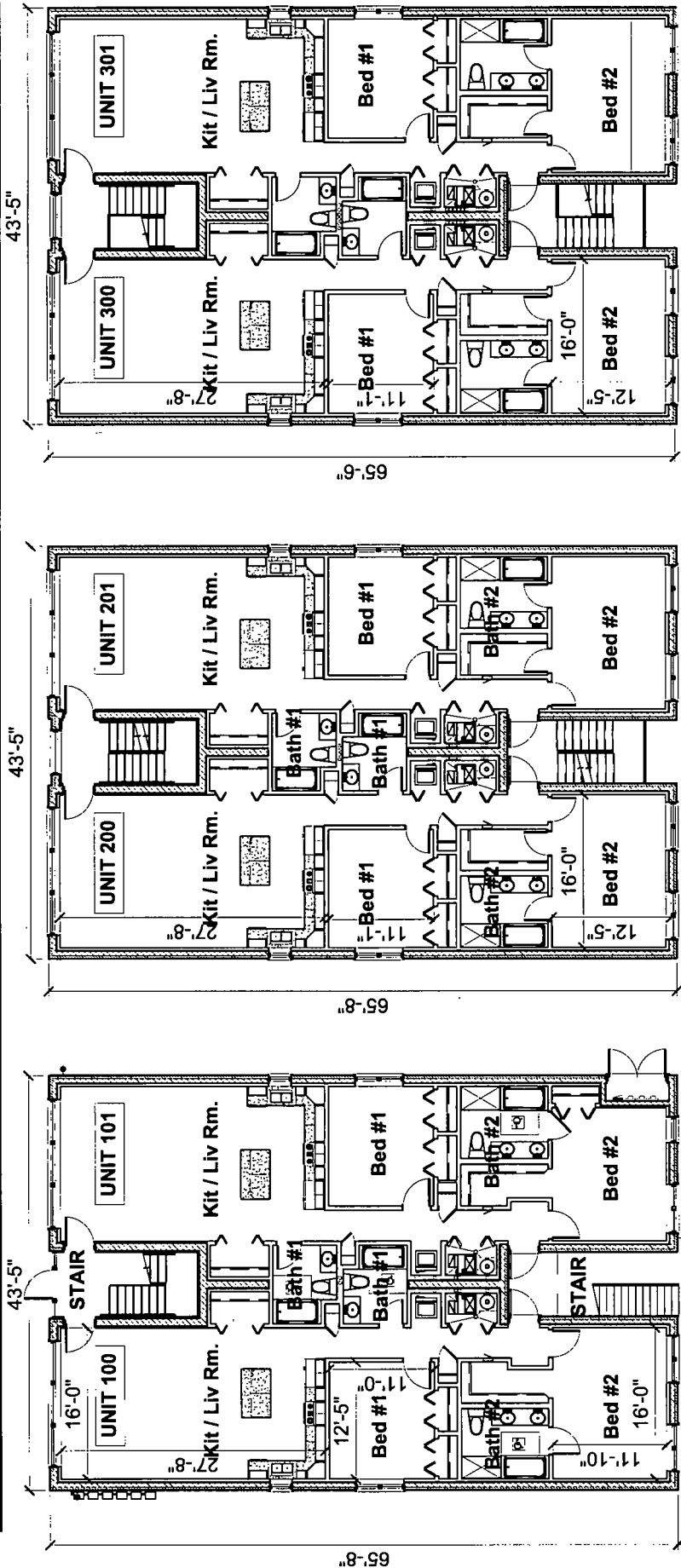

THIRD FLOOR PLAN  
Scale: 1/4" = 1'-0"

2601-03 N.  
HARLEM AVE.  
(BUILDING #1)

FIRST FLOOR PLAN  
Scale: 1/4" = 1'-0"

SECOND FLOOR PLAN  
Scale: 1/4" = 1'-0"



X I O S ARCHITECTS AND CONSULTANTS LTD.  
144 N. WELLS  
CHICAGO, ILLINOIS 60601  
TEL: 312.786.1322  
FAX: 312.786.1323

# 2601-03 N. Harlem Avenue, Chicago II.

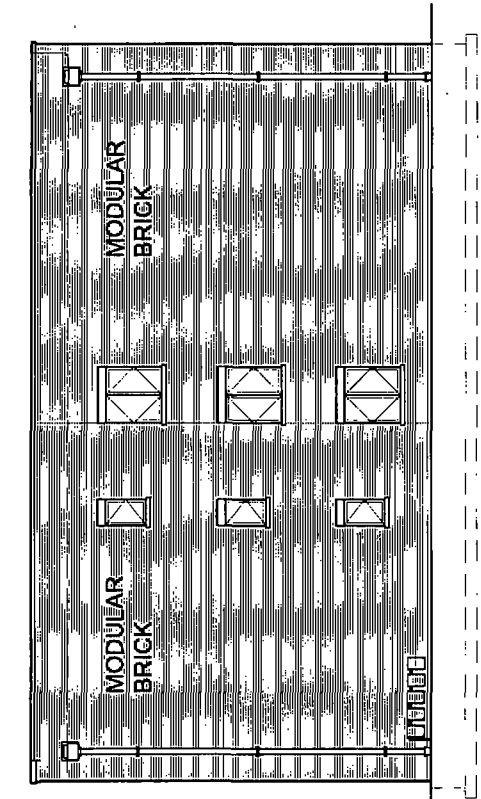

T/ PARAPET WALL  
 EL +35'-4"  
 B/ ROOF TRUSS  
 EL +30'-6"

T/ 3RS FLOOR  
 EL +21'-4"

T/ 2ND FLOOR  
 EL +10'-8"

T/ GRADE T/ 1ST FLOOR  
 EL +0'-0"

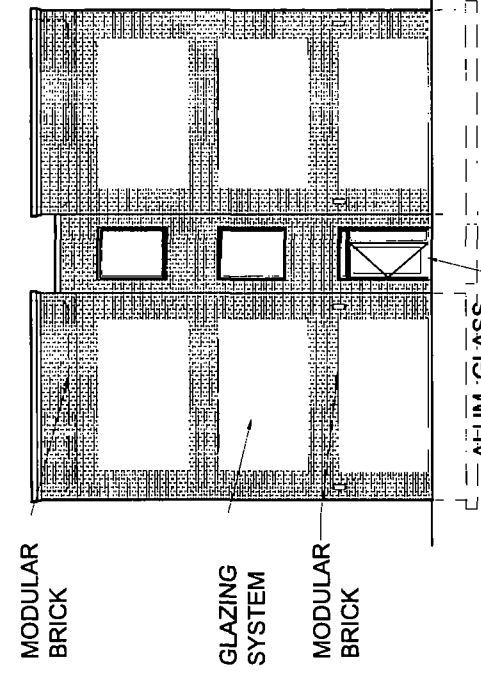

MODULAR BRICK

GLAZING SYSTEM

MODULAR BRICK

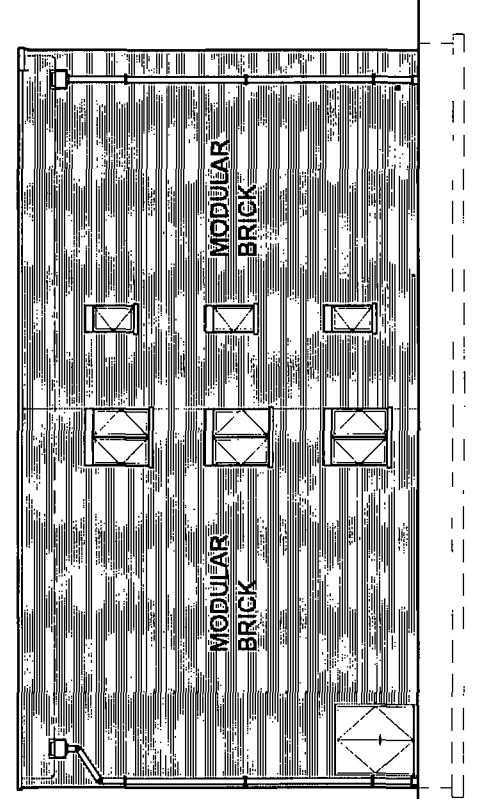

T/ PARAPET WALL  
 EL +35'-4"  
 B/ ROOF TRUSS  
 EL +30'-6"

T/ 3RS FLOOR  
 EL +21'-4"

T/ 2ND FLOOR  
 EL +10'-8"

T/ GRADE T/ 1ST FLOOR  
 EL +0'-0"

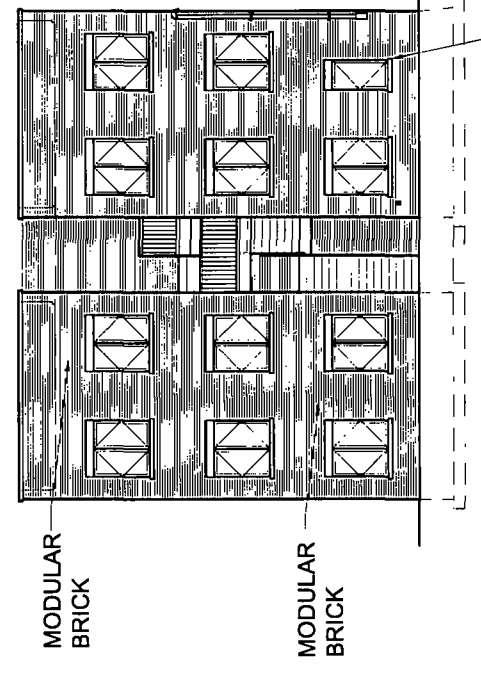

MODULAR BRICK

MODULAR BRICK

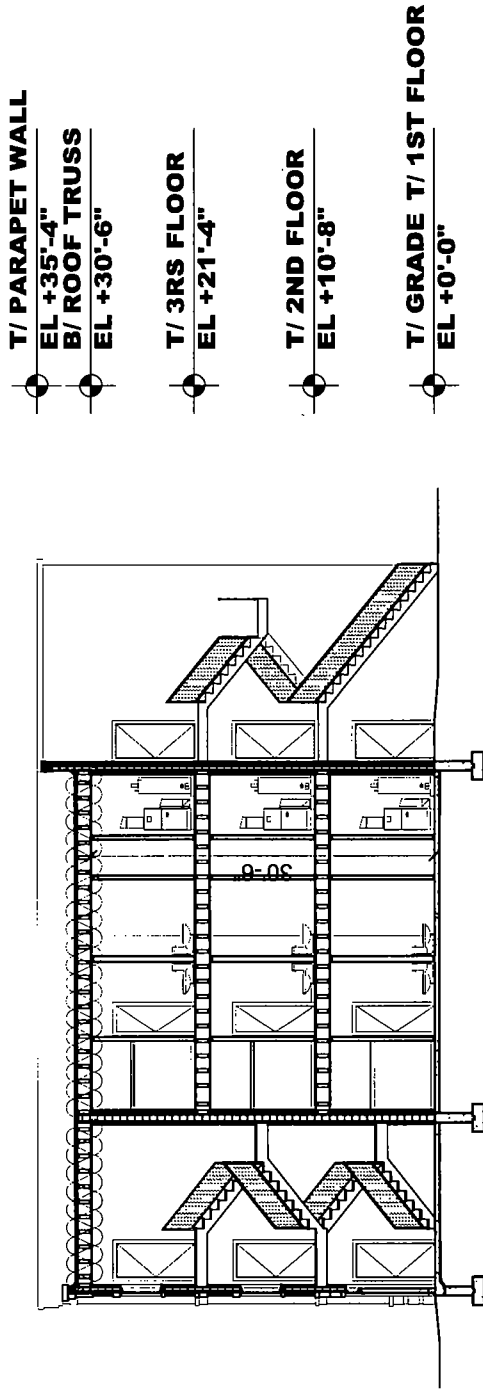

T/ PARAPET WALL

EL +35'-4"

B/ ROOF TRUSS

EL +30'-6"

T/ 3RS FLOOR

EL +21'-4"

T/ 2ND FLOOR

EL +10'-8"

T/ GRADE T/ 1ST FLOOR

EL +0'-0"

1 BUILDING SECTION

Scale: 1/4" = 1'-0"

P5





W. WRIGHTWOOD AVENUE

2607-09 N. Harlem Avenue, Chicago IL.

N. HARLEM AVENUE

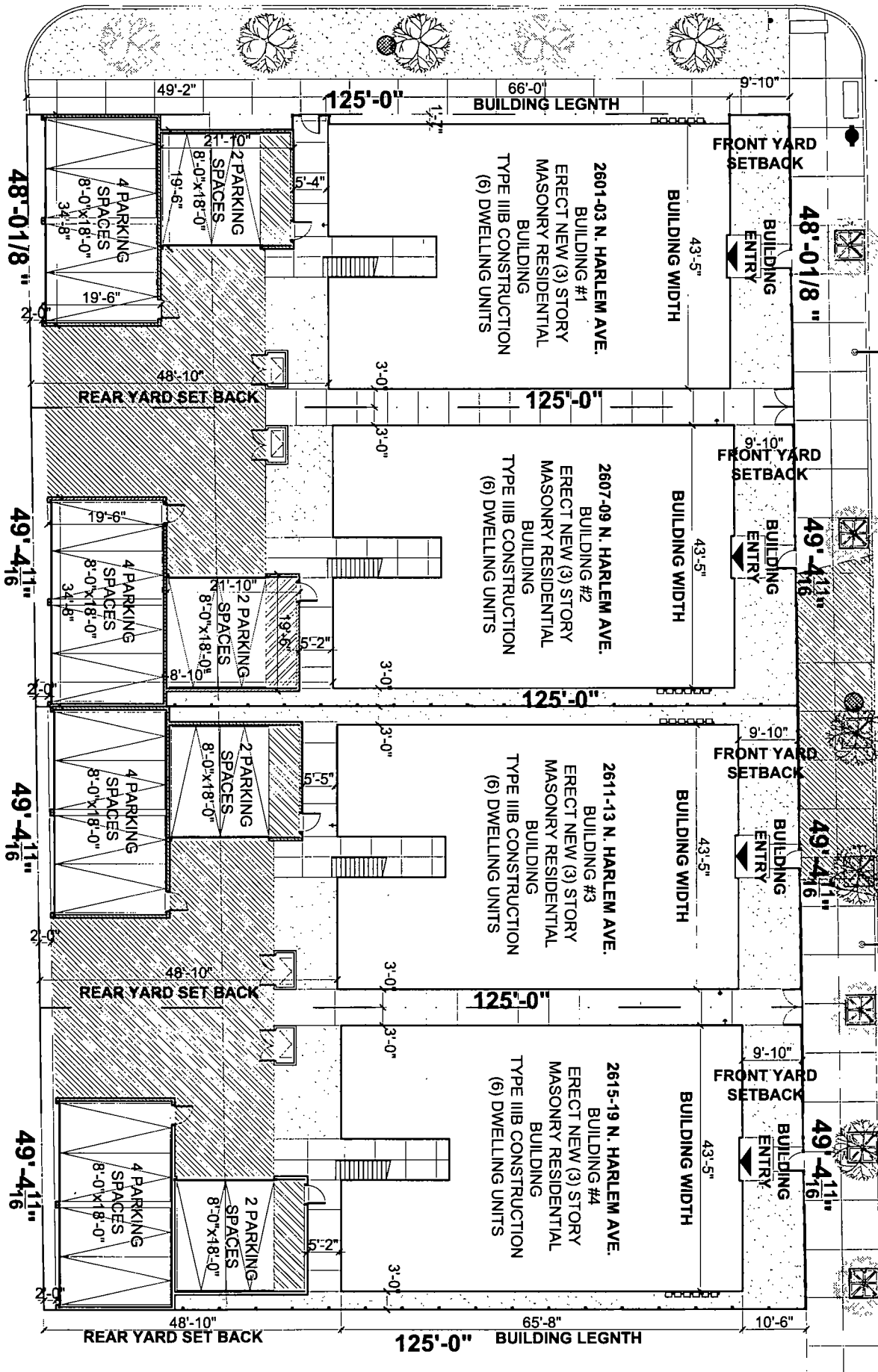

16'-0" PUBLIC ALLEY

2607-09 N. Harlem Avenue, Chicago IL.

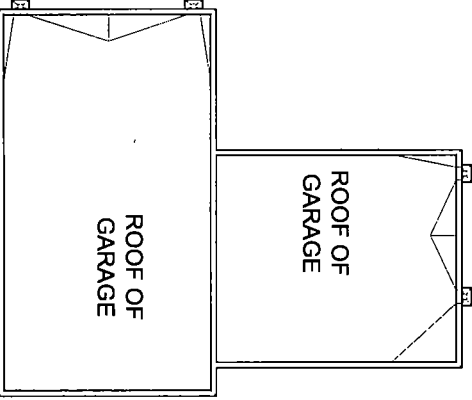
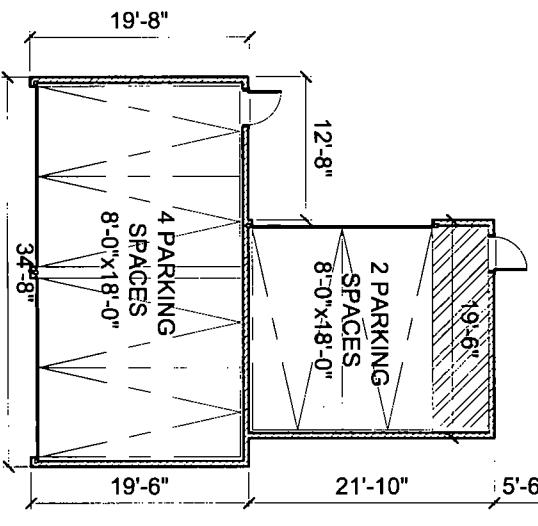
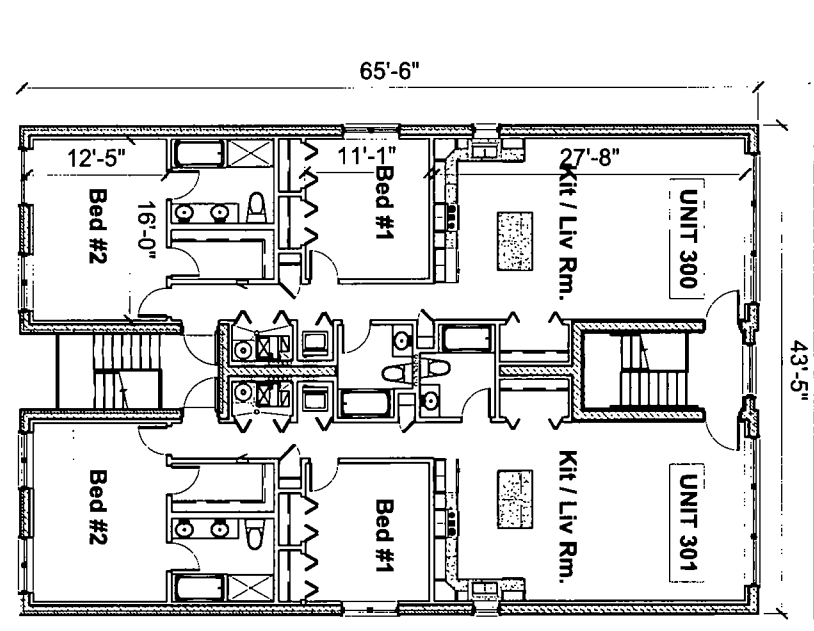
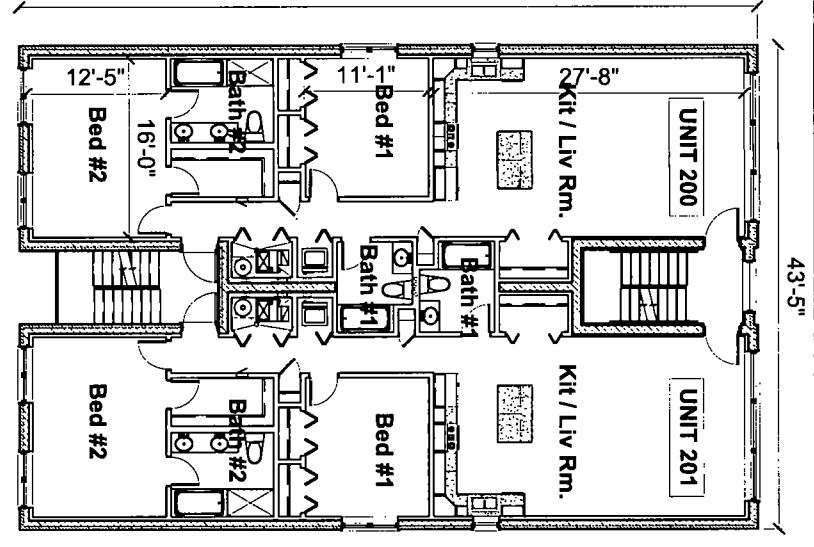
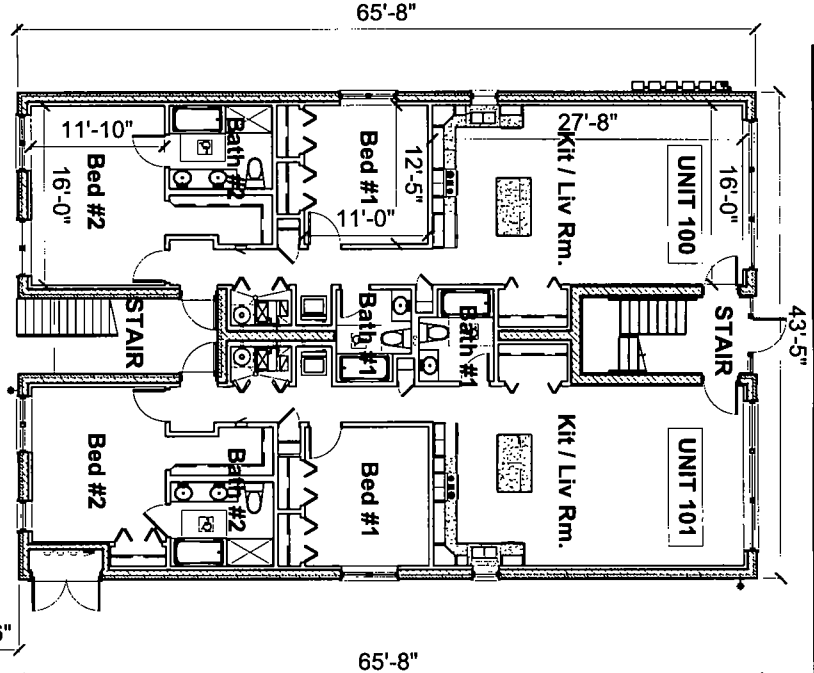

2607-09 N.  
HARLEM AVE.  
(BUILDING #2)

THIRD FLOOR PLAN  
Scale N.T.S.

FIRST FLOOR PLAN  
Scale N.T.S.

SECOND FLOOR PLAN  
Scale N.T.S.



X I O S ARCHITECTS AND CONSULTANTS LTD.

1111 N. LAUREL ST. CHICAGO, ILLINOIS 60610

TEL: 312.333.1333 FAX: 312.333.1333

# 2607-09 N. Harlem Avenue, Chicago IL.

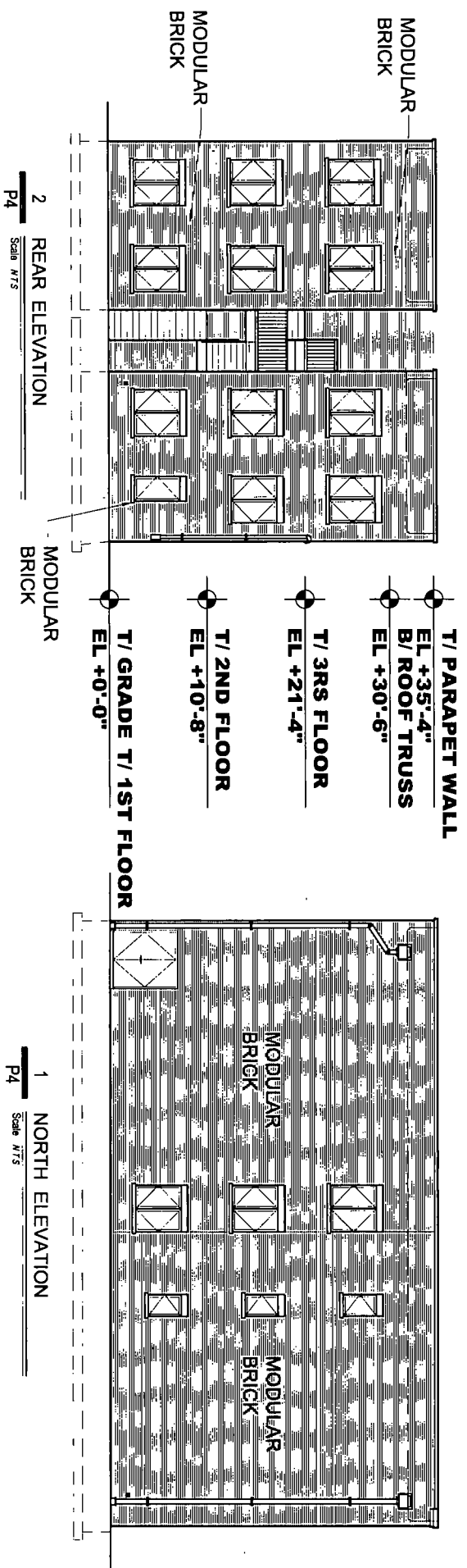
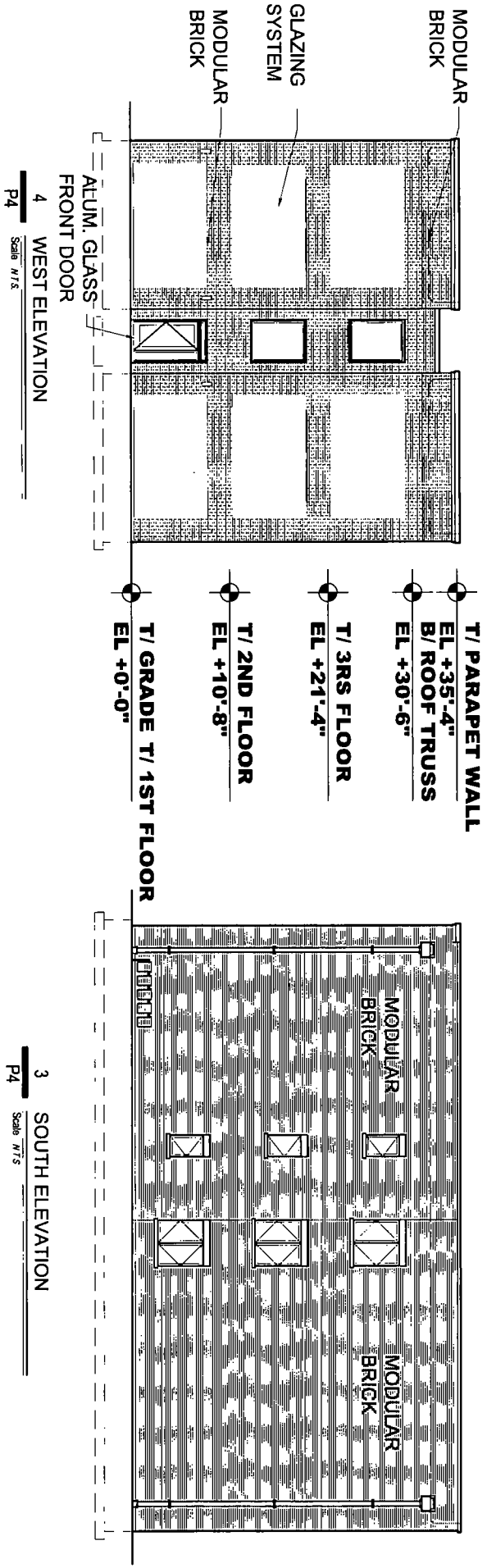

X I O S ARCHITECTS AND CONSULTANTS LTD  
1147 W. FULLER  
SUITE 200 CHICAGO, ILLINOIS 60644  
TEL: 312.224.1333

2607-09 N. Harlem Avenue, Chicago IL.

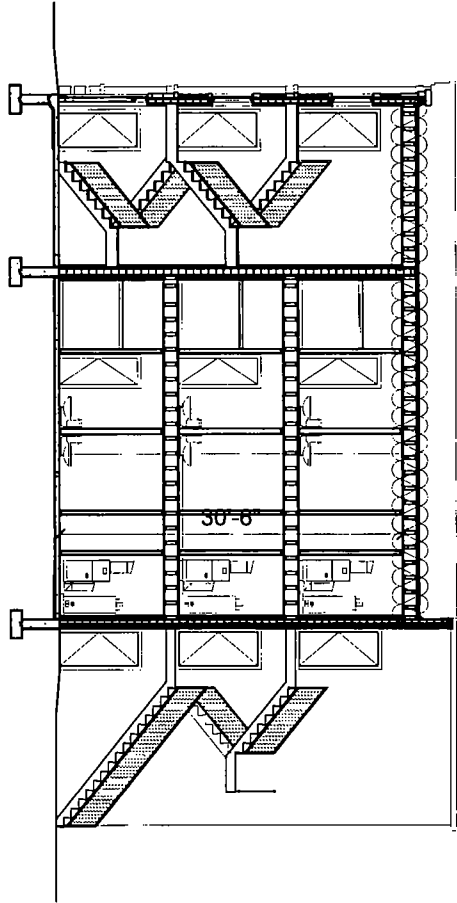

1 BUILDING SECTION  
Scale: A1/S

- T/ PARAPET WALL  
EL +35'-4"
- B/ ROOF TRUSS  
EL +30'-6"
- T/ 3RS FLOOR  
EL +21'-4"
- T/ 2ND FLOOR  
EL +10'-8"
- T/ GRADE T/ 1ST FLOOR  
EL +0'-0"



X I O S ARCHITECTS AND CONSULTANTS LTD  
1411 N. MICHIGAN  
CHICAGO, ILLINOIS 60610  
TEL: 312.733.1333  
FAX: 312.733.1333

W. WRIGHTWOOD AVENUE

2611-13 N. Harlem Avenue, Chicago IL.

N. HARLEM AVENUE

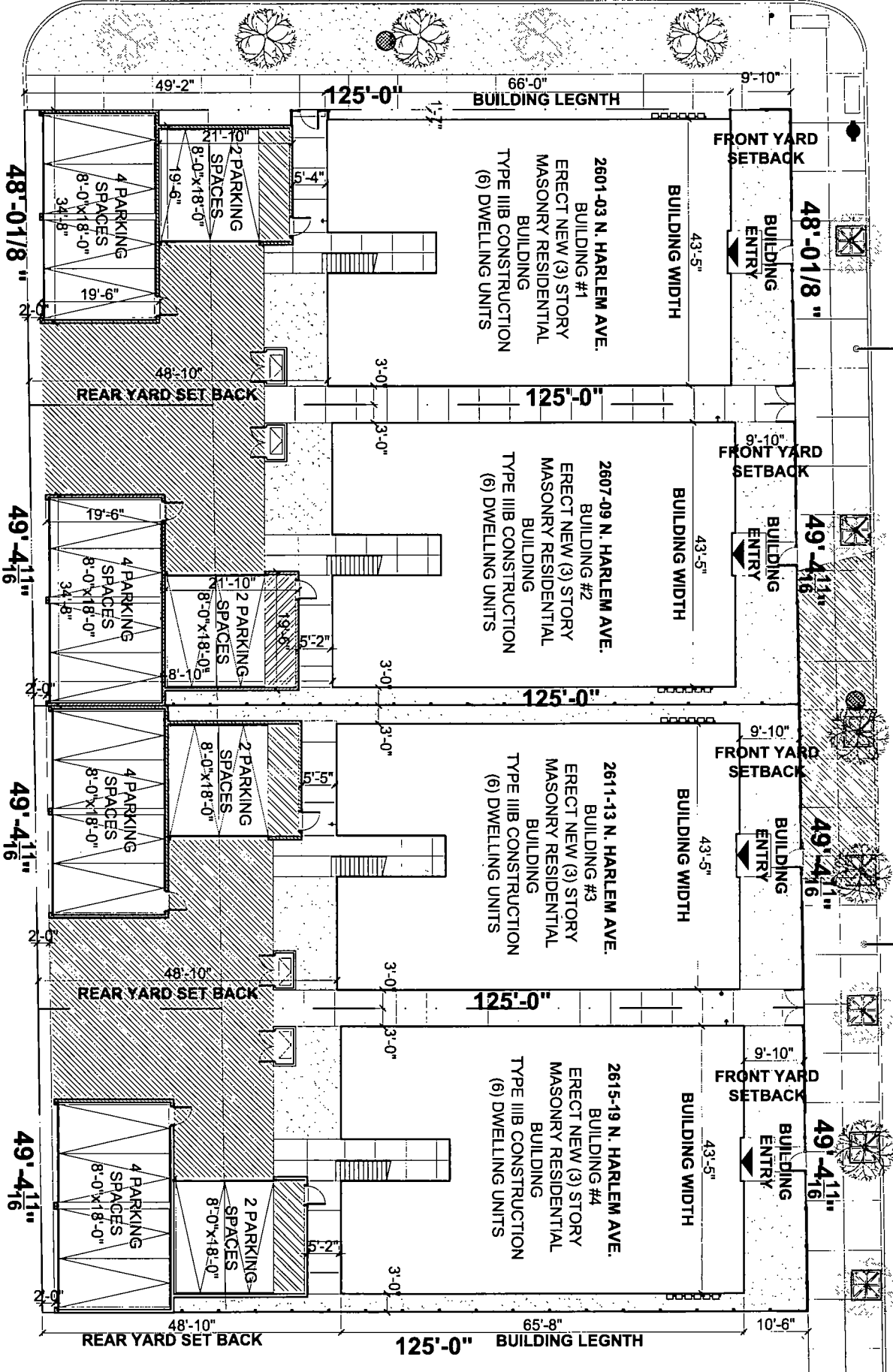

X I O S ARCHITECTS AND CONSULTANTS LTD.  
 1015 N. WILSON  
 CHICAGO, ILLINOIS 60642  
 TEL: 312.288.2222  
 FAX: 312.288.2222

1 SITE PLAN  
 Scale: 1/8" = 1'-0"

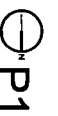

JUNE 8, 2012

2611-1-13 N. Harlem Avenue, Chicago IL.

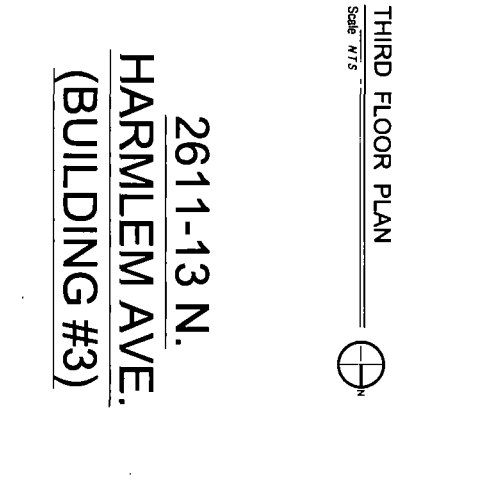
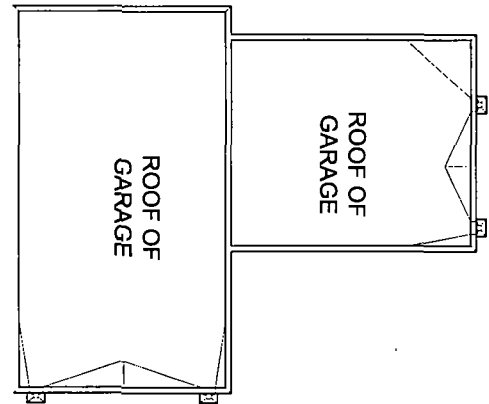
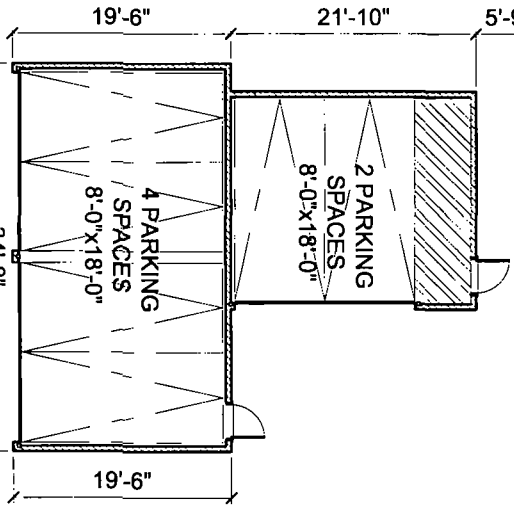
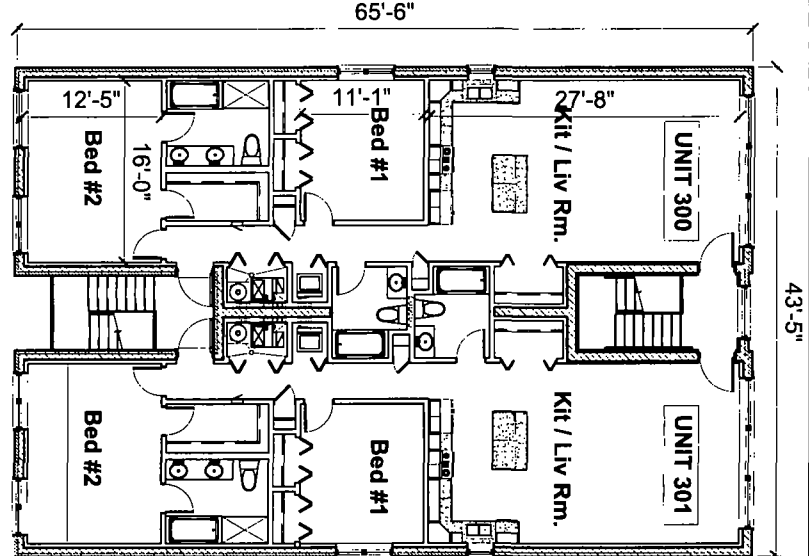
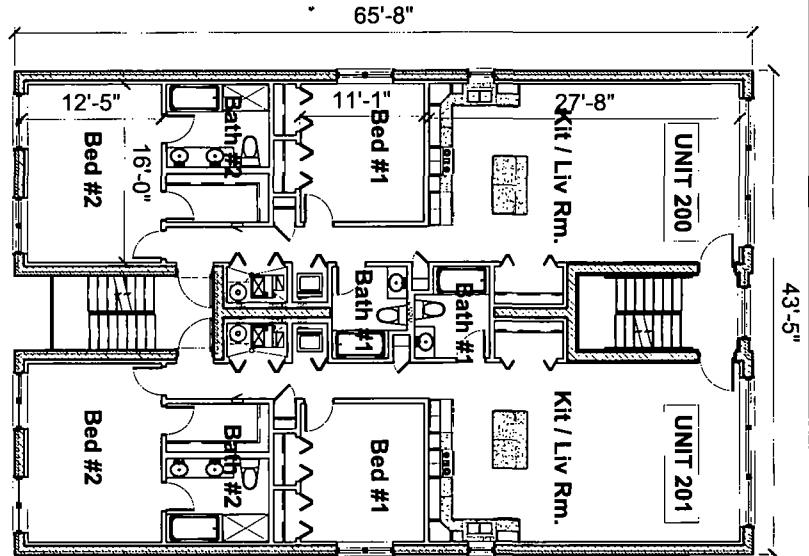
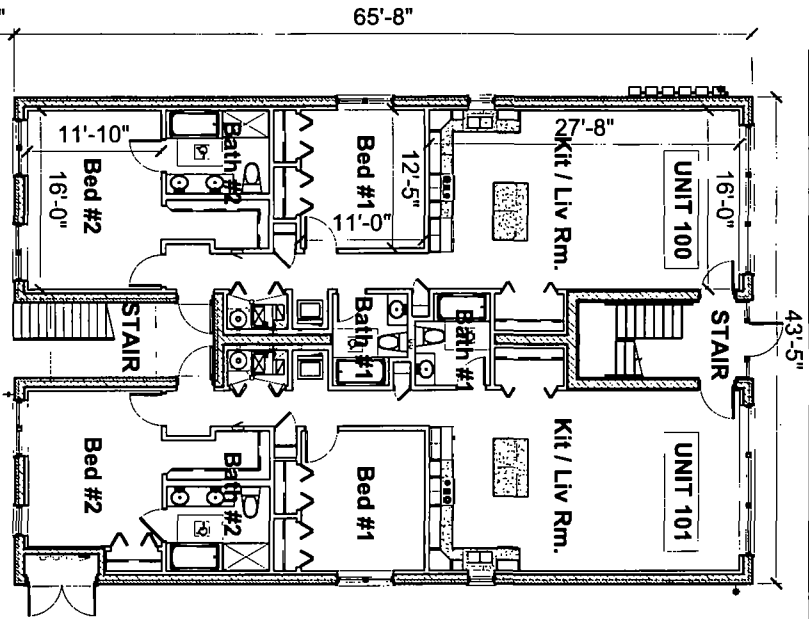

FIRST FLOOR PLAN

SECOND FLOOR PLAN

THIRD FLOOR PLAN



Scale: N.T.S.

X I O S ARCHITECTS AND CONSULTANTS LTD.



Scale: N.T.S.



Scale: N.T.S.



2611-1-13 N.  
HARLEM AVE.  
(BUILDING #3)

# 2611-13 N. Harlem Avenue, Chicago IL.

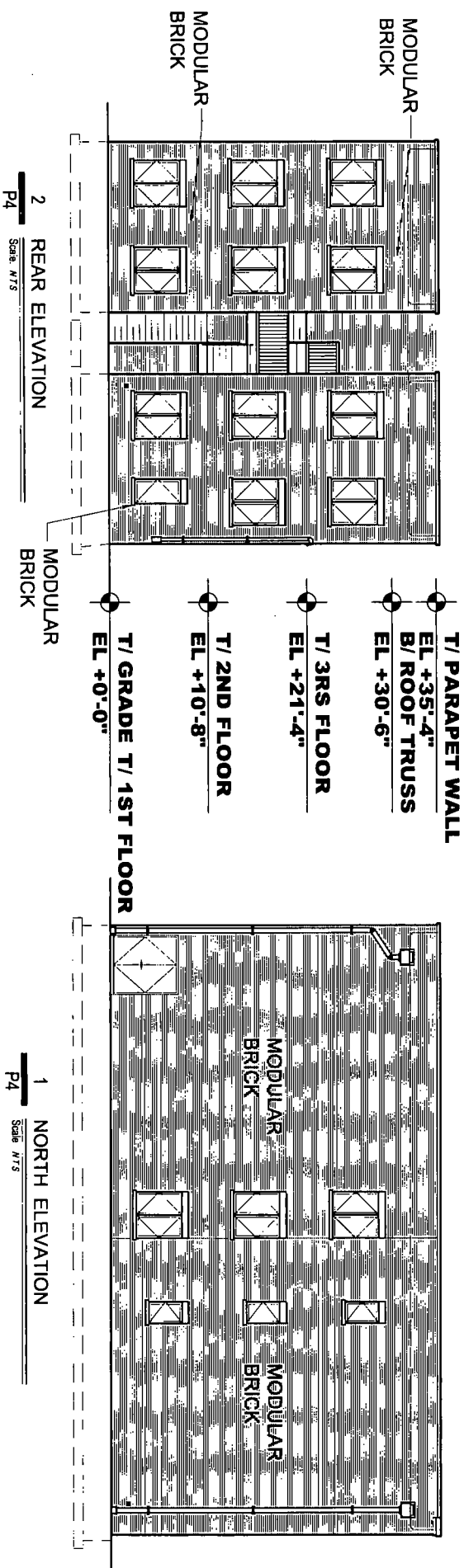
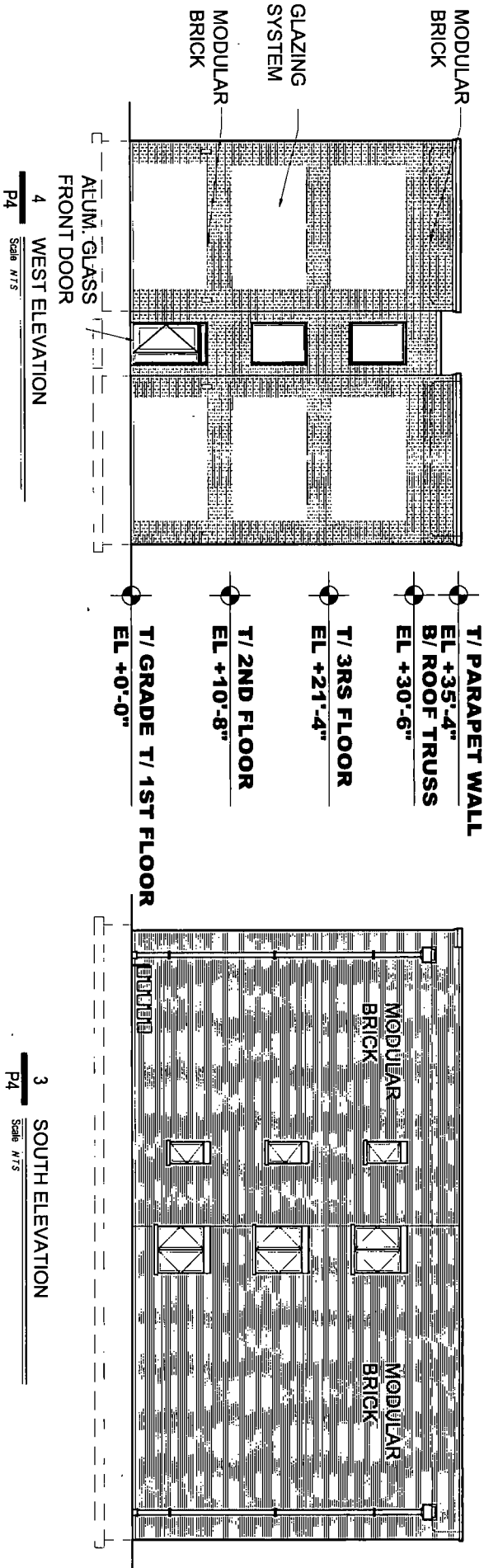

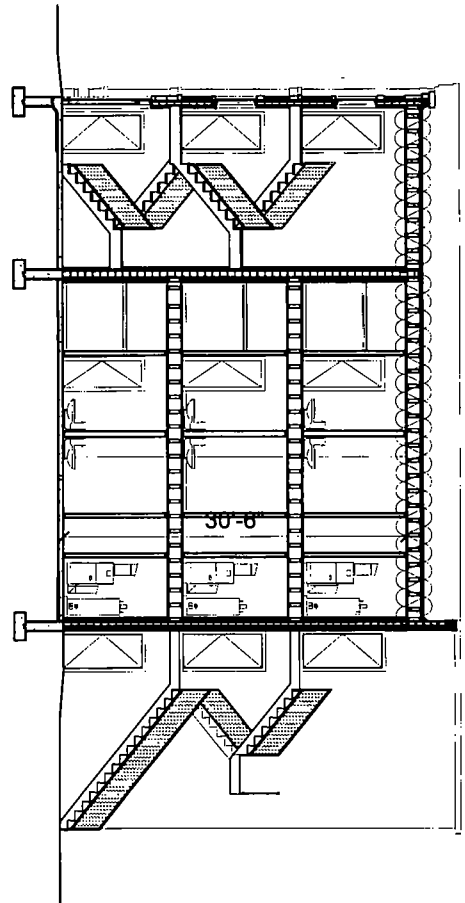

1 BUILDING SECTION  
P5 Scale: 1/8" = 1'-0"

- T/ PARAPET WALL  
EL +35'-4"
- B/ ROOF TRUSS  
EL +30'-6"
- T/ 3RS FLOOR  
EL +21'-4"
- T/ 2ND FLOOR  
EL +10'-8"
- T/ GRADE T/ 1ST FLOOR  
EL +0'-0"





W. WRIGHTWOOD AVENUE

2615-19 N. Harlem Avenue, Chicago IL.

N. HARLEM AVENUE

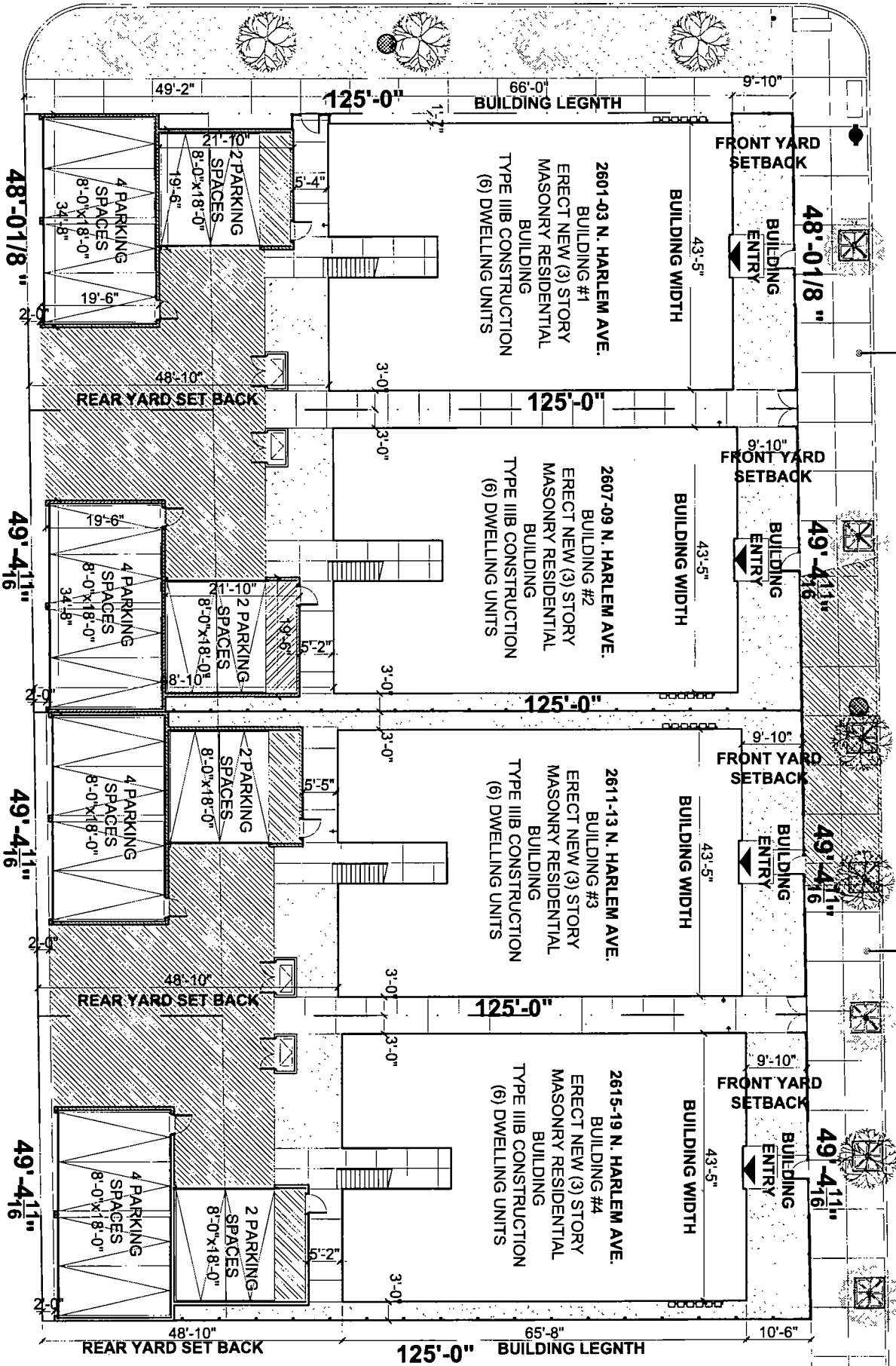

- 16'-0" PUBLIC ALLEY -



X I O S ARCHITECTS AND CONSULTANTS LTD.  
 1111 S. MICHIGAN  
 SUITE 200 CHICAGO, ILLINOIS 60605  
 TEL: 312.222.2222  
 FAX: 312.222.2222

1 SITE PLAN  
 Scale: N/T/S



APRIL 8, 2013

2615-19 N. Harlem Avenue, Chicago IL.

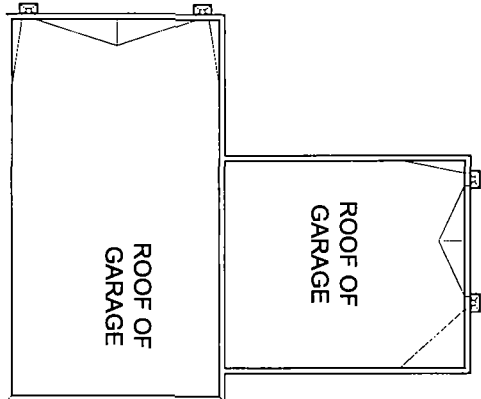
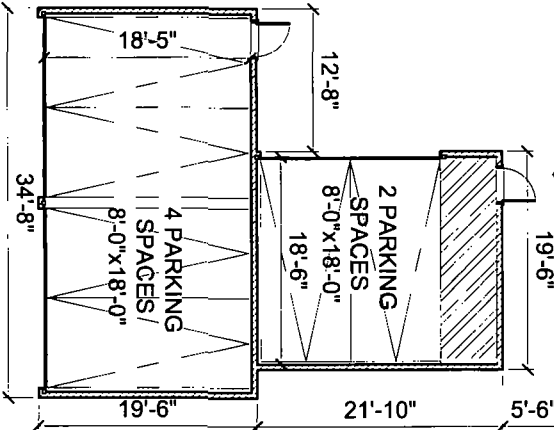
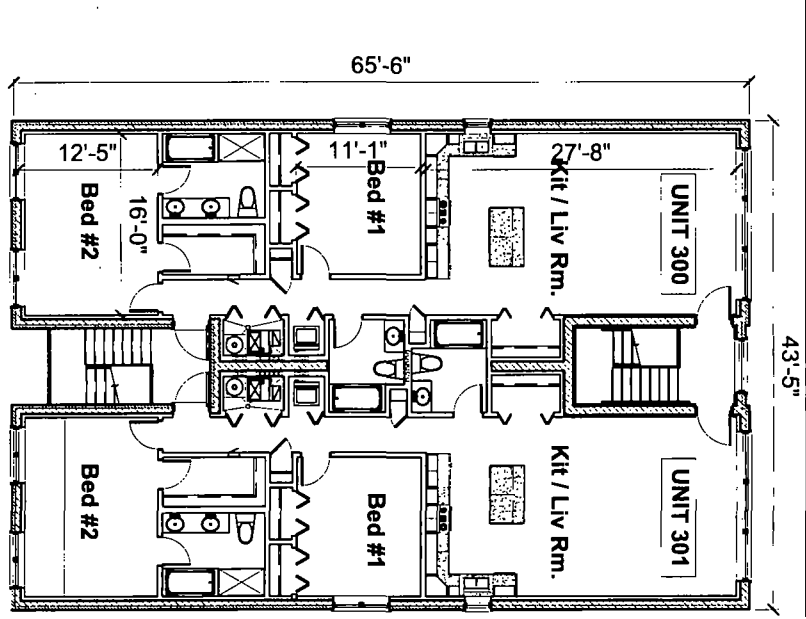
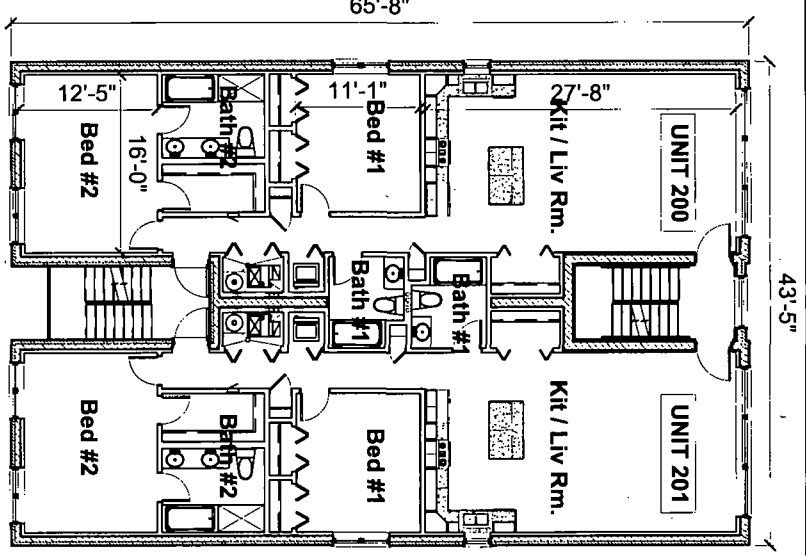
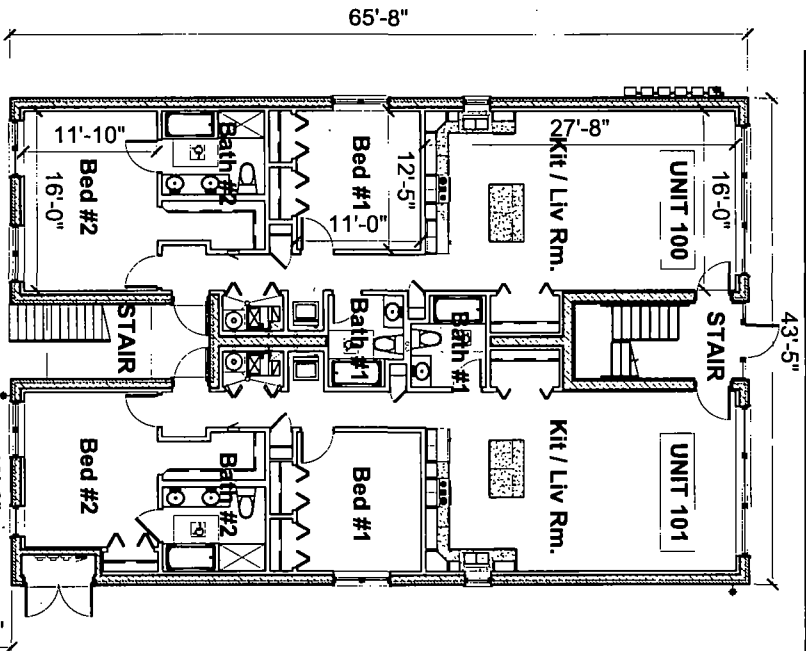

FIRST FLOOR PLAN

SECOND FLOOR PLAN

THIRD FLOOR PLAN



Scale: N.T.S.  
 X I O S ARCHITECTS AND CONSULTANTS LTD.  
 1000 N. LAKE ST. SUITE 200  
 CHICAGO, ILLINOIS 60610  
 TEL: 312.224.2222  
 FAX: 312.224.2223

2615-19 N.  
 HARLEM AVE.  
 (BUILDING #4)

# 2615-19 N. Harlem Avenue, Chicago IL.

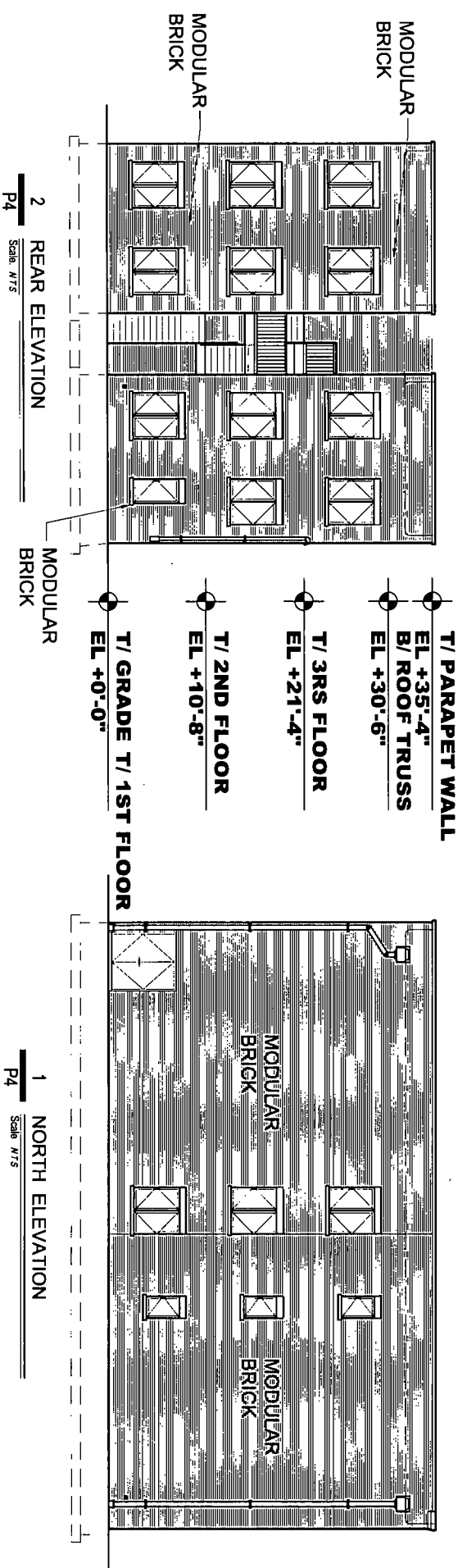
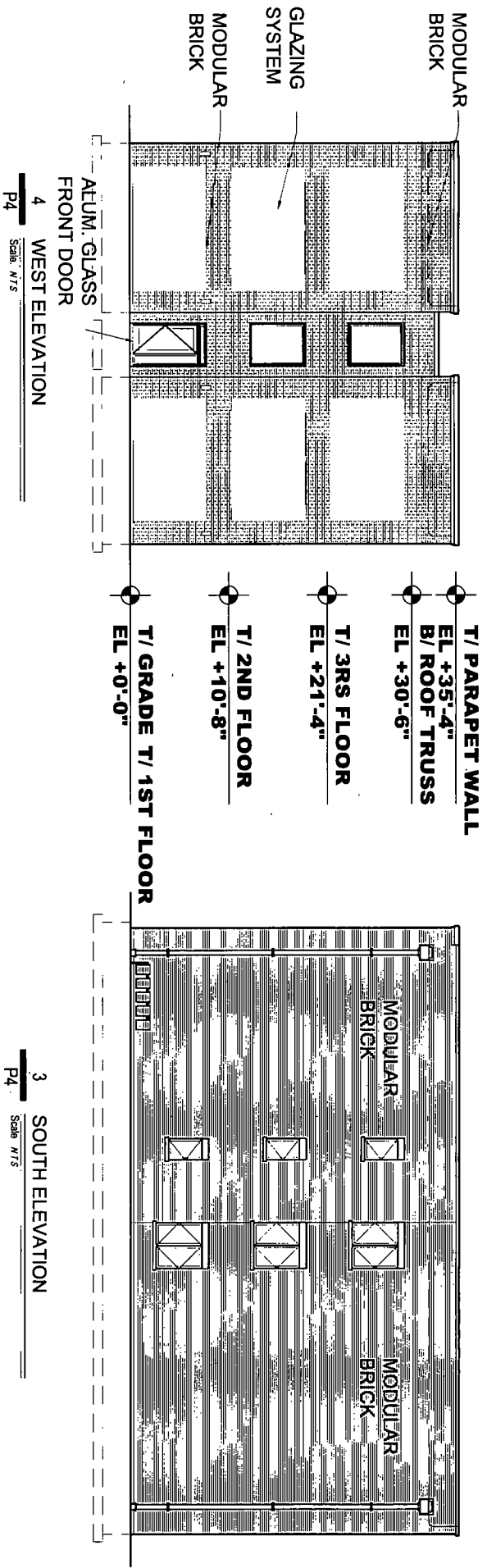

X | O | S ARCHITECTS AND CONSULTANTS LTD.  
 1000 N. LAKE ST. CHICAGO, ILLINOIS 60610  
 TEL: 312.224.2222 FAX: 312.224.2222

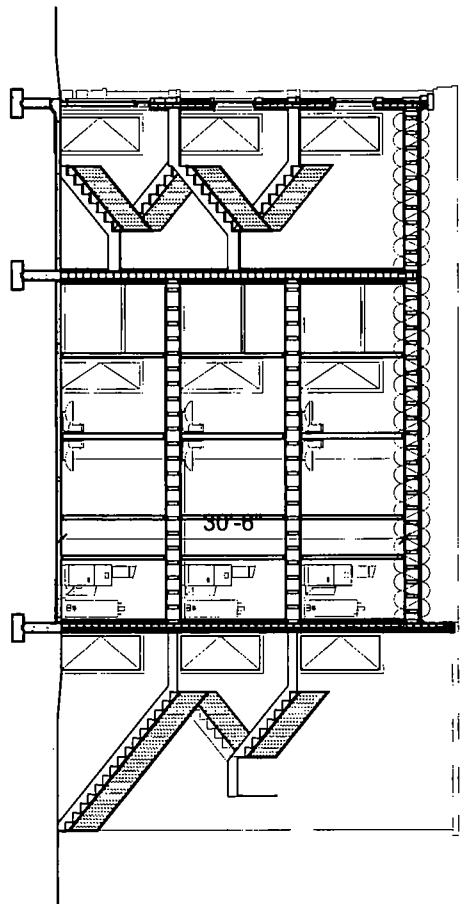

1 BUILDING SECTION  
Scale: 1/8" = 1'-0"

- T/ PARAPET WALL  
EL +35'-4"
- B/ ROOF TRUSS  
EL +30'-6"
- T/ 3RS FLOOR  
EL +21'-4"
- T/ 2ND FLOOR  
EL +10'-8"
- T/ GRADE T/ 1ST FLOOR  
EL +0'-0"





**Written Notice, Form of Affidavit: Section 17-13-0107**

September 7, 2016

Honorable Daniel Solis  
Chairman, Committee on Zoning  
121 North LaSalle Street  
Room 304 - City Hall  
Chicago, Illinois 60602

To Whom It May Concern:

The undersigned, Nicholas Ftikas, being first duly sworn on oath, deposes and says the following:

That the undersigned certifies that he has complied with the requirements of Section 17-13-0107 of the Zoning Code of the City of Chicago, by sending written notice to such property owners who appear to be the owners of the property within the subject area not solely owned by the applicant, and on the owners of all property within 250 feet in each direction of the lot line of the subject property, exclusive of the public roads, streets, alleys and other public ways, or a total distance limited to 400 feet. Said written notice was sent by USPS First Class Mail no more than 30 days before filing the application.

The undersigned certifies that the notice contained the address of the property sought to be rezoned as **2601-2619 N. Harlem Ave., Chicago, Illinois**; a statement of intended use of said property; the name and address of the Applicant; the name and address of the owner; and a statement that the applicant intends to file an amended application for a change in zoning on approximately **September 7, 2016**.

The Applicant has made a bonafide effort to determine the addresses of the parties to be notified under Section 17-13-0107 of the Zoning Code of the City of Chicago; that the Applicant certifies that the accompanying list of names and addresses of surrounding property owners within 250 feet is a complete list containing the names and last known addresses of the owners of the property required to be served.

Law Offices of Samuel V.P. Banks

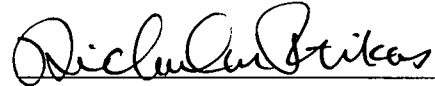

By: **Nicholas Ftikas**, Attorney

Subscribed and Sworn to before me  
this the 7th Day of September, 2016.

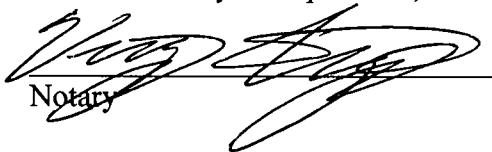

Notary

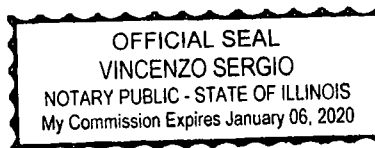

**PUBLIC NOTICE**

*Via USPS First Class Mail*  
September 7, 2016

Dear Sir or Madam:

In accordance with the Amendment to the Chicago Zoning Code enacted by the City Council, Section 17-13-0107-A, please be informed that on or about September 7, 2016, I, the undersigned, intend to file an application for a change in zoning from the M1-1 Limited Manufacturing/Business Park District and B1-1 Neighborhood Shopping District to a uniform B2-2 Neighborhood Mixed-Use District, on behalf of the Applicant, Noah Properties, LLC, for the subject property located at **2601-2619 N. Harlem Ave., Chicago, Illinois.**

The subject property will be divided into four (4) new zoning lots. Each resulting zoning lot will be developed with a new three-story building that will contain six (6) residential units. Onsite parking for six (6) cars will be located at the rear of each new zoning lot. Each building will be 30 feet 6 inches in height. Each building will be masonry construction.

The Applicant, Noah Properties, LLC, is located at 3009 W. Montrose, Chicago, IL 60618.

The Property Owners, 2601 Harlem, LLC and 2605 Harlem, LLC, are located at 520 E. North Ave., Carol Stream, IL 60188.

I am the attorney for the Applicant, and I will serve as the contact person for this zoning application. My address is 221 N. LaSalle St., 38<sup>th</sup> Floor, Chicago, IL 60601. My telephone number is 312-782-1983.

Very truly yours,

LAW OFFICES OF SAMUEL V.P. BANKS



Nicholas Ftikas

**\*Please note that the Applicant is NOT seeking to purchase or rezone your property.**

**\*The Applicant is required by law to send this notice because you own property located within 250 feet of the property subject to the proposed Zoning Amendment.**

To whom it may concern:

I, Bart Przyjemski, on behalf of Noah Properties, LLC, the Contract Purchaser and Applicant concerning the subject property located at 2601-2619 N. Harlem Ave., Chicago, IL, authorize the Law Offices of Samuel V.P. Banks to file a zoning amendment application with the City of Chicago for that property.



---

Bart Przyjemski  
Noah Properties, LLC



**FORM OF AFFIDAVIT**

Chairman, Committee on Zoning  
Room 304 - City Hall  
Chicago, IL 60602

To Whom It May Concern:

I, Bart Przyjemski, on behalf of Noah Properties, LLC, understand that the Law Offices of Samuel V.P. Banks has filed a sworn affidavit identifying Noah Properties, LLC, as the Contract Purchaser and Applicant holding an interest in the land subject to the proposed zoning amendment and identified as 2601-2619 N. Harlem Ave., Chicago, IL.

I, Bart Przyjemski, on behalf of Noah Properties, LLC, being first duly sworn under oath, depose and say that Noah Properties, LLC, holds that interest for itself and no other person, association, or shareholder.

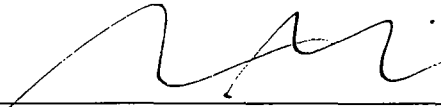

Bart Przyjemski  
Noah Properties, LLC

Date

Subscribed and Sworn to before me  
this 6 day of September, 2016

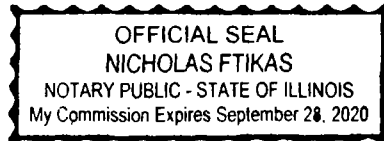
  
Notary Public

THE UNIVERSITY OF CHICAGO  
LIBRARY  
540 EAST 57TH STREET  
CHICAGO, ILL. 60637  
TEL: 773-936-3200

UNIVERSITY OF CHICAGO  
LIBRARY

#18970TV

INTRO. DATE:

9-14-16

CITY OF CHICAGO  
APPLICATION FOR AN AMENDMENT TO  
THE CHICAGO ZONING ORDINANCE

1. ADDRESS of the property Applicant is seeking to rezone:  
2601-2619 N. Harlem Ave., Chicago, IL

2. Ward Number that property is located in: 29

3. APPLICANT: Noah Properties, LLC

ADDRESS: 3009 W. Montrose CITY: Chicago

STATE: Illinois ZIP CODE: 60618 PHONE: (312) 782-1983

EMAIL: nick@sambankslaw.com CONTACT PERSON: Nicholas Ftikas

4. Is the Applicant the owner of the property? YES \_\_\_ NO x

If the Applicant is not the owner of the property, please provide the following information regarding the owner and attach written authorization from the owner allowing the application to proceed.

PROPERTY OWNER: 2601 Harlem, LLC

ADDRESS: 520 E. North Ave. CITY: Carol Stream

STATE: IL ZIP CODE: 60188 PHONE: (312) 782-1983

EMAIL: nick@sambankslaw.com CONTACT PERSON: Nicholas Ftikas

\*Applicant's Attorney

PROPERTY OWNER: 2605 Harlem, LLC

ADDRESS: 520 E. North Ave. CITY: Carol Stream

STATE: IL ZIP CODE: 60188 PHONE: (312) 782-1983

EMAIL: nick@sambankslaw.com CONTACT PERSON: Nicholas Ftikas

\*Applicant's Attorney

5. If the Applicant/Owner of the property has obtained a lawyer as their representative for the rezoning, please provide the following information:

ATTORNEY: Law Offices of Samuel V.P. Banks

ADDRESS: 221 North LaSalle Street, 38<sup>th</sup> Floor

CITY: Chicago STATE: Illinois ZIP CODE: 60601

PHONE: (312) 782-1983 FAX: (312) 782-2433 EMAIL: nick@sambankslaw.com

6. If the applicant is a legal entity (Corporation, LLC, Partnership, etc.), please provide the names of all owners as disclosed on the Economic Disclosure Statements.  
Bart Przyjemski, Manager of Noah Properties, LLC - Applicant  
Robertino Presta and Antonella Presta, Managers of 2601 Harlem, LLC and 2605 Harlem, LLC – Property Owners
7. On what date did the owner acquire legal title to the subject property? 1988
8. Has the present owner previously rezoned this property? If Yes, when? No
9. Present Zoning District: M1-1 and B1-1 Proposed Zoning District: B2-2
10. Lot size in square feet (or dimensions): 24,523.75 sq. ft.
11. Current Use of the Property: The subject property is improved with two (2) retail buildings that are both currently vacant.
12. Reason for rezoning the property: In order to permit the property to be developed with four (4) new six-unit residential buildings.
13. Describe the proposed use of the property after the rezoning. Indicate the number of dwelling units; number of parking spaces; approximate square footage of any commercial space; and height of the proposed building. (BE SPECIFIC)  
The subject property will be divided into four (4) new zoning lots. Each resulting zoning lot will be developed with a new three-story building that will contain six (6) residential units. Onsite parking for six (6) cars will be located at the rear of each new zoning lot. Each building will be 30 feet 6 inches in height. Each building will be masonry construction.
14. The Affordable Requirements Ordinance (ARO) requires on-site affordable housing units and/or a financial contribution for residential housing projects with ten or more units that receive a zoning change which, among other triggers, increases the allowable floor area, or, for existing Planned Developments, increases the number of units (see attached fact sheet or visit [www.cityofchicago.org/ARO](http://www.cityofchicago.org/ARO) for more information). Is this project subject to the ARO?  
YES X NO

=====

COUNTY OF COOK  
STATE OF ILLINOIS

I, Bart Przyjemski, in my capacity as Manager of Noah Properties, LLC, being first duly sworn on oath, state that all of the above statements and the statements contained in the documents submitted herewith are, to the best of my knowledge, true and correct.

  
\_\_\_\_\_  
Signature of Applicant

Subscribed and Sworn to before me this  
6<sup>th</sup> day of September, 2016.

  
\_\_\_\_\_  
Notary Public

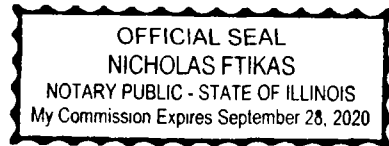

=====

For Office Use Only

Date of Introduction: \_\_\_\_\_

File Number: \_\_\_\_\_

Ward: \_\_\_\_\_

1. The first part of the document is a list of names and addresses of the members of the committee. The names are listed in alphabetical order, and the addresses are listed below each name. The list includes names such as Mr. J. H. Smith, Mr. J. B. Jones, and Mr. W. C. Brown.

2. The second part of the document is a list of names and addresses of the members of the committee. The names are listed in alphabetical order, and the addresses are listed below each name. The list includes names such as Mr. J. H. Smith, Mr. J. B. Jones, and Mr. W. C. Brown.

**CITY OF CHICAGO  
ECONOMIC DISCLOSURE STATEMENT  
AND AFFIDAVIT**

**SECTION I -- GENERAL INFORMATION**

A. Legal name of the Disclosing Party submitting this EDS. Include d/b/a/ if applicable:

Noah Properties LLC

**Check ONE of the following three boxes:**

Indicate whether the Disclosing Party submitting this EDS is:

1.  the Applicant

OR

2.  a legal entity holding a direct or indirect interest in the Applicant. State the legal name of the Applicant in which the Disclosing Party holds an interest: \_\_\_\_\_

OR

3.  a legal entity with a right of control (see Section II.B.1.) State the legal name of the entity in which the Disclosing Party holds a right of control: \_\_\_\_\_

B. Business address of the Disclosing Party: 3009 W Montrose Ave.

Chicago, Illinois, 60608

C. Telephone: 312-782-1983 Fax: 312-782-2433 Email: nick@sambankslaw.com

D. Name of contact person: Nicholas Fikas - Applicant's Attorney

E. Federal Employer Identification No. (if you have one): \_\_\_\_\_

F. Brief description of contract, transaction or other undertaking (referred to below as the "Matter") to which this EDS pertains. (Include project number and location of property, if applicable):

The Applicant is seeking a zoning map amendment for the property located at 2601-19 N. Harlem

G. Which City agency or department is requesting this EDS? DPD/COZ

If the Matter is a contract being handled by the City's Department of Procurement Services, please complete the following:

Specification # \_\_\_\_\_ and Contract # \_\_\_\_\_

**SECTION II -- DISCLOSURE OF OWNERSHIP INTERESTS**

**A. NATURE OF THE DISCLOSING PARTY**

1. Indicate the nature of the Disclosing Party:

- |   |   |
|---|---|
| <input type="checkbox"/> Person                                   | <input checked="" type="checkbox"/> Limited liability company |
| <input type="checkbox"/> Publicly registered business corporation | <input type="checkbox"/> Limited liability partnership        |
| <input type="checkbox"/> Privately held business corporation      | <input type="checkbox"/> Joint venture                        |
| <input type="checkbox"/> Sole proprietorship                      | <input type="checkbox"/> Not-for-profit corporation           |
| <input type="checkbox"/> General partnership                      | (Is the not-for-profit corporation also a 501(c)(3))?         |
| <input type="checkbox"/> Limited partnership                      | Yes <input type="checkbox"/> No <input type="checkbox"/>      |
| <input type="checkbox"/> Trust                                    | <input type="checkbox"/> Other (please specify)               |

2. For legal entities, the state (or foreign country) of incorporation or organization, if applicable:

Illinois

3. For legal entities not organized in the State of Illinois: Has the organization registered to do business in the State of Illinois as a foreign entity?

Yes  No  N/A

**B. IF THE DISCLOSING PARTY IS A LEGAL ENTITY:**

1. List below the full names and titles of all executive officers and all directors of the entity.

**NOTE:** For not-for-profit corporations, also list below all members, if any, which are legal entities. If there are no such members, write "no members." For trusts, estates or other similar entities, list below the legal titleholder(s).

If the entity is a general partnership, limited partnership, limited liability company, limited liability partnership or joint venture, list below the name and title of each general partner, managing member, manager or any other person or entity that controls the day-to-day management of the Disclosing Party.

**NOTE:** Each legal entity listed below must submit an EDS on its own behalf.

Name	Title
Bart Przyjemski	Manager

2. Please provide the following information concerning each person or entity having a direct or indirect beneficial interest (including ownership) in excess of 7.5% of the Disclosing Party. Examples of such an interest include shares in a corporation, partnership interest in a partnership or joint venture,



interest of a member or manager in a limited liability company, or interest of a beneficiary of a trust, estate or other similar entity. If none, state "None." **NOTE:** Pursuant to Section 2-154-030 of the Municipal Code of Chicago ("Municipal Code"), the City may require any such additional information from any applicant which is reasonably intended to achieve full disclosure.

Name	Business Address	Percentage Interest in the Disclosing Party
Bart Przyjemski	3009 W. Montrose Ave Chicago, Illinois, 60608	100%

### SECTION III -- BUSINESS RELATIONSHIPS WITH CITY ELECTED OFFICIALS

Has the Disclosing Party had a "business relationship," as defined in Chapter 2-156 of the Municipal Code, with any City elected official in the 12 months before the date this EDS is signed?

Yes

No

If yes, please identify below the name(s) of such City elected official(s) and describe such relationship(s):

---

---

### SECTION IV -- DISCLOSURE OF SUBCONTRACTORS AND OTHER RETAINED PARTIES

The Disclosing Party must disclose the name and business address of each subcontractor, attorney, lobbyist, accountant, consultant and any other person or entity whom the Disclosing Party has retained or expects to retain in connection with the Matter, as well as the nature of the relationship, and the total amount of the fees paid or estimated to be paid. The Disclosing Party is not required to disclose employees who are paid solely through the Disclosing Party's regular payroll.

"Lobbyist" means any person or entity who undertakes to influence any legislative or administrative action on behalf of any person or entity other than: (1) a not-for-profit entity, on an unpaid basis, or (2) himself. "Lobbyist" also means any person or entity any part of whose duties as an employee of another includes undertaking to influence any legislative or administrative action.

If the Disclosing Party is uncertain whether a disclosure is required under this Section, the Disclosing Party must either ask the City whether disclosure is required or make the disclosure.

Name (indicate whether retained or anticipated to be retained)	Business Address	Relationship to Disclosing Party (subcontractor, attorney, lobbyist, etc.)	Fees (indicate whether paid or estimated.) <b>NOTE:</b> "hourly rate" or "t.b.d." is not an acceptable response.
Law Offices of Samuel VP Banks	221 N LaSalle St, 38th Floor Chicago, Illinois, 60601	Attorney	\$12,500 (est.)

(Add sheets if necessary)

Check here if the Disclosing Party has not retained, nor expects to retain, any such persons or entities.

**SECTION V -- CERTIFICATIONS**

**A. COURT-ORDERED CHILD SUPPORT COMPLIANCE**

Under Municipal Code Section 2-92-415, substantial owners of business entities that contract with the City must remain in compliance with their child support obligations throughout the contract's term.

Has any person who directly or indirectly owns 10% or more of the Disclosing Party been declared in arrearage on any child support obligations by any Illinois court of competent jurisdiction?

Yes       No       No person directly or indirectly owns 10% or more of the Disclosing Party.

If "Yes," has the person entered into a court-approved agreement for payment of all support owed and is the person in compliance with that agreement?

Yes       No

**B. FURTHER CERTIFICATIONS**

1. Pursuant to Municipal Code Chapter 1-23, Article I ("Article I")(which the Applicant should consult for defined terms (e.g., "doing business") and legal requirements), if the Disclosing Party submitting this EDS is the Applicant and is doing business with the City, then the Disclosing Party certifies as follows: (i) neither the Applicant nor any controlling person is currently indicted or charged with, or has admitted guilt of, or has ever been convicted of, or placed under supervision for, any criminal offense involving actual, attempted, or conspiracy to commit bribery, theft, fraud, forgery, perjury, dishonesty or deceit against an officer or employee of the City or any sister agency; and (ii) the Applicant understands and acknowledges that compliance with Article I is a continuing requirement for doing business with the City. **NOTE:** If Article I applies to the Applicant, the permanent compliance timeframe in Article I supersedes some five-year compliance timeframes in certifications 2 and 3 below.

2. The Disclosing Party and, if the Disclosing Party is a legal entity, all of those persons or entities identified in Section II.B.1. of this EDS:

- a. are not presently debarred, suspended, proposed for debarment, declared ineligible or voluntarily excluded from any transactions by any federal, state or local unit of government;
- b. have not, within a five-year period preceding the date of this EDS, been convicted of a criminal offense, adjudged guilty, or had a civil judgment rendered against them in connection with: obtaining, attempting to obtain, or performing a public (federal, state or local) transaction or contract under a public transaction; a violation of federal or state antitrust statutes; fraud; embezzlement; theft; forgery; bribery; falsification or destruction of records; making false statements; or receiving stolen property;
- c. are not presently indicted for, or criminally or civilly charged by, a governmental entity (federal, state or local) with committing any of the offenses set forth in clause B.2.b. of this Section V;
- d. have not, within a five-year period preceding the date of this EDS, had one or more public transactions (federal, state or local) terminated for cause or default; and
- e. have not, within a five-year period preceding the date of this EDS, been convicted, adjudged guilty, or found liable in a civil proceeding, or in any criminal or civil action, including actions concerning environmental violations, instituted by the City or by the federal government, any state, or any other unit of local government.

3. The certifications in subparts 3, 4 and 5 concern:

- the Disclosing Party;
- any "Contractor" (meaning any contractor or subcontractor used by the Disclosing Party in connection with the Matter, including but not limited to all persons or legal entities disclosed under Section IV, "Disclosure of Subcontractors and Other Retained Parties");
- any "Affiliated Entity" (meaning a person or entity that, directly or indirectly: controls the Disclosing Party, is controlled by the Disclosing Party, or is, with the Disclosing Party, under common control of another person or entity. Indicia of control include, without limitation: interlocking management or ownership; identity of interests among family members, shared facilities and equipment; common use of employees; or organization of a business entity following the ineligibility of a business entity to do business with federal or state or local government, including the City, using substantially the same management, ownership, or principals as the ineligible entity); with respect to Contractors, the term Affiliated Entity means a person or entity that directly or indirectly controls the Contractor, is controlled by it, or, with the Contractor, is under common control of another person or entity;
- any responsible official of the Disclosing Party, any Contractor or any Affiliated Entity or any other official, agent or employee of the Disclosing Party, any Contractor or any Affiliated Entity, acting pursuant to the direction or authorization of a responsible official of the Disclosing Party, any Contractor or any Affiliated Entity (collectively "Agents").

Neither the Disclosing Party, nor any Contractor, nor any Affiliated Entity of either the Disclosing Party or any Contractor nor any Agents have, during the five years before the date this EDS is signed, or, with respect to a Contractor, an Affiliated Entity, or an Affiliated Entity of a Contractor during the five years before the date of such Contractor's or Affiliated Entity's contract or engagement in connection with the Matter:

- a. bribed or attempted to bribe, or been convicted or adjudged guilty of bribery or attempting to bribe, a public officer or employee of the City, the State of Illinois, or any agency of the federal government or of any state or local government in the United States of America, in that officer's or employee's official capacity;
- b. agreed or colluded with other bidders or prospective bidders, or been a party to any such agreement, or been convicted or adjudged guilty of agreement or collusion among bidders or prospective bidders, in restraint of freedom of competition by agreement to bid a fixed price or otherwise; or
- c. made an admission of such conduct described in a. or b. above that is a matter of record, but have not been prosecuted for such conduct; or
- d. violated the provisions of Municipal Code Section 2-92-610 (Living Wage Ordinance).

4. Neither the Disclosing Party, Affiliated Entity or Contractor, or any of their employees, officials, agents or partners, is barred from contracting with any unit of state or local government as a result of engaging in or being convicted of (1) bid-rigging in violation of 720 ILCS 5/33E-3; (2) bid-rotating in violation of 720 ILCS 5/33E-4; or (3) any similar offense of any state or of the United States of America that contains the same elements as the offense of bid-rigging or bid-rotating.

5. Neither the Disclosing Party nor any Affiliated Entity is listed on any of the following lists maintained by the Office of Foreign Assets Control of the U.S. Department of the Treasury or the Bureau of Industry and Security of the U.S. Department of Commerce or their successors: the Specially Designated Nationals List, the Denied Persons List, the Unverified List, the Entity List and the Debarred List.

6. The Disclosing Party understands and shall comply with the applicable requirements of Chapters 2-55 (Legislative Inspector General), 2-56 (Inspector General) and 2-156 (Governmental Ethics) of the Municipal Code.

7. If the Disclosing Party is unable to certify to any of the above statements in this Part B (Further Certifications), the Disclosing Party must explain below:

---

---

---

---

If the letters "NA," the word "None," or no response appears on the lines above, it will be conclusively presumed that the Disclosing Party certified to the above statements.

8. To the best of the Disclosing Party's knowledge after reasonable inquiry, the following is a complete list of all current employees of the Disclosing Party who were, at any time during the 12-month period preceding the execution date of this EDS, an employee, or elected or appointed official, of the City of Chicago (if none, indicate with "N/A" or "none").

None

---

---

---

9. To the best of the Disclosing Party's knowledge after reasonable inquiry, the following is a complete list of all gifts that the Disclosing Party has given or caused to be given, at any time during the 12-month period preceding the execution date of this EDS, to an employee, or elected or appointed official, of the City of Chicago. For purposes of this statement, a "gift" does not include: (i) anything made generally available to City employees or to the general public, or (ii) food or drink provided in the course of official City business and having a retail value of less than \$20 per recipient (if none, indicate with "N/A" or "none"). As to any gift listed below, please also list the name of the City recipient.

None

---

---

---

C. CERTIFICATION OF STATUS AS FINANCIAL INSTITUTION

1. The Disclosing Party certifies that the Disclosing Party (check one)

is  is not

a "financial institution" as defined in Section 2-32-455(b) of the Municipal Code.

2. If the Disclosing Party IS a financial institution, then the Disclosing Party pledges:

"We are not and will not become a predatory lender as defined in Chapter 2-32 of the Municipal Code. We further pledge that none of our affiliates is, and none of them will become, a predatory lender as defined in Chapter 2-32 of the Municipal Code. We understand that becoming a predatory lender or becoming an affiliate of a predatory lender may result in the loss of the privilege of doing business with the City."

If the Disclosing Party is unable to make this pledge because it or any of its affiliates (as defined in Section 2-32-455(b) of the Municipal Code) is a predatory lender within the meaning of Chapter 2-32 of the Municipal Code, explain here (attach additional pages if necessary):

---

---

---

If the letters "NA," the word "None," or no response appears on the lines above, it will be conclusively presumed that the Disclosing Party certified to the above statements.

**D. CERTIFICATION REGARDING INTEREST IN CITY BUSINESS**

Any words or terms that are defined in Chapter 2-156 of the Municipal Code have the same meanings when used in this Part D.

1. In accordance with Section 2-156-110 of the Municipal Code: Does any official or employee of the City have a financial interest in his or her own name or in the name of any other person or entity in the Matter?

Yes  No

NOTE: If you checked "Yes" to Item D.1., proceed to Items D.2. and D.3. If you checked "No" to Item D.1., proceed to Part E.

2. Unless sold pursuant to a process of competitive bidding, or otherwise permitted, no City elected official or employee shall have a financial interest in his or her own name or in the name of any other person or entity in the purchase of any property that (i) belongs to the City, or (ii) is sold for taxes or assessments, or (iii) is sold by virtue of legal process at the suit of the City (collectively, "City Property Sale"). Compensation for property taken pursuant to the City's eminent domain power does not constitute a financial interest within the meaning of this Part D.

Does the Matter involve a City Property Sale?

Yes  No

3. If you checked "Yes" to Item D.1., provide the names and business addresses of the City officials or employees having such interest and identify the nature of such interest:

Name	Business Address	Nature of Interest

4. The Disclosing Party further certifies that no prohibited financial interest in the Matter will be acquired by any City official or employee.

**E. CERTIFICATION REGARDING SLAVERY ERA BUSINESS**

Please check either 1. or 2. below. If the Disclosing Party checks 2., the Disclosing Party must disclose below or in an attachment to this EDS all information required by paragraph 2. Failure to

comply with these disclosure requirements may make any contract entered into with the City in connection with the Matter voidable by the City.

1. The Disclosing Party verifies that the Disclosing Party has searched any and all records of the Disclosing Party and any and all predecessor entities regarding records of investments or profits from slavery or slaveholder insurance policies during the slavery era (including insurance policies issued to slaveholders that provided coverage for damage to or injury or death of their slaves), and the Disclosing Party has found no such records.

2. The Disclosing Party verifies that, as a result of conducting the search in step 1 above, the Disclosing Party has found records of investments or profits from slavery or slaveholder insurance policies. The Disclosing Party verifies that the following constitutes full disclosure of all such records, including the names of any and all slaves or slaveholders described in those records:

---

---

---

---

## SECTION VI -- CERTIFICATIONS FOR FEDERALLY FUNDED MATTERS

**NOTE: If the Matter is federally funded, complete this Section VI. If the Matter is not federally funded, proceed to Section VII. For purposes of this Section VI, tax credits allocated by the City and proceeds of debt obligations of the City are not federal funding.**

### A. CERTIFICATION REGARDING LOBBYING

1. List below the names of all persons or entities registered under the federal Lobbying Disclosure Act of 1995 who have made lobbying contacts on behalf of the Disclosing Party with respect to the Matter: (Add sheets if necessary):

---

---

---

(If no explanation appears or begins on the lines above, or if the letters "NA" or if the word "None" appear, it will be conclusively presumed that the Disclosing Party means that NO persons or entities registered under the Lobbying Disclosure Act of 1995 have made lobbying contacts on behalf of the Disclosing Party with respect to the Matter.)

2. The Disclosing Party has not spent and will not expend any federally appropriated funds to pay any person or entity listed in Paragraph A.1. above for his or her lobbying activities or to pay any person or entity to influence or attempt to influence an officer or employee of any agency, as defined by applicable federal law, a member of Congress, an officer or employee of Congress, or an employee of a member of Congress, in connection with the award of any federally funded contract, making any federally funded grant or loan, entering into any cooperative agreement, or to extend, continue, renew, amend, or modify any federally funded contract, grant, loan, or cooperative agreement.

3. The Disclosing Party will submit an updated certification at the end of each calendar quarter in which there occurs any event that materially affects the accuracy of the statements and information set forth in paragraphs A.1. and A.2. above.

4. The Disclosing Party certifies that either: (i) it is not an organization described in section 501(c)(4) of the Internal Revenue Code of 1986; or (ii) it is an organization described in section 501(c)(4) of the Internal Revenue Code of 1986 but has not engaged and will not engage in "Lobbying Activities".

5. If the Disclosing Party is the Applicant, the Disclosing Party must obtain certifications equal in form and substance to paragraphs A.1. through A.4. above from all subcontractors before it awards any subcontract and the Disclosing Party must maintain all such subcontractors' certifications for the duration of the Matter and must make such certifications promptly available to the City upon request.

#### B. CERTIFICATION REGARDING EQUAL EMPLOYMENT OPPORTUNITY

If the Matter is federally funded, federal regulations require the Applicant and all proposed subcontractors to submit the following information with their bids or in writing at the outset of negotiations.

Is the Disclosing Party the Applicant?

Yes

No

If "Yes," answer the three questions below:

1. Have you developed and do you have on file affirmative action programs pursuant to applicable federal regulations? (See 41 CFR Part 60-2.)

Yes

No

2. Have you filed with the Joint Reporting Committee, the Director of the Office of Federal Contract Compliance Programs, or the Equal Employment Opportunity Commission all reports due under the applicable filing requirements?

Yes

No

3. Have you participated in any previous contracts or subcontracts subject to the equal opportunity clause?

Yes

No

If you checked "No" to question 1. or 2. above, please provide an explanation:

---

---



## **SECTION VII -- ACKNOWLEDGMENTS, CONTRACT INCORPORATION, COMPLIANCE, PENALTIES, DISCLOSURE**

The Disclosing Party understands and agrees that:

A. The certifications, disclosures, and acknowledgments contained in this EDS will become part of any contract or other agreement between the Applicant and the City in connection with the Matter, whether procurement, City assistance, or other City action, and are material inducements to the City's execution of any contract or taking other action with respect to the Matter. The Disclosing Party understands that it must comply with all statutes, ordinances, and regulations on which this EDS is based.

B. The City's Governmental Ethics and Campaign Financing Ordinances, Chapters 2-156 and 2-164 of the Municipal Code, impose certain duties and obligations on persons or entities seeking City contracts, work, business, or transactions. The full text of these ordinances and a training program is available on line at [www.cityofchicago.org/Ethics](http://www.cityofchicago.org/Ethics), and may also be obtained from the City's Board of Ethics, 740 N.

Sedgwick St., Suite 500, Chicago, IL 60610, (312) 744-9660. The Disclosing Party must comply fully with the applicable ordinances.

C. If the City determines that any information provided in this EDS is false, incomplete or inaccurate, any contract or other agreement in connection with which it is submitted may be rescinded or be void or voidable, and the City may pursue any remedies under the contract or agreement (if not rescinded or void), at law, or in equity, including terminating the Disclosing Party's participation in the Matter and/or declining to allow the Disclosing Party to participate in other transactions with the City. Remedies at law for a false statement of material fact may include incarceration and an award to the City of treble damages.

D. It is the City's policy to make this document available to the public on its Internet site and/or upon request. Some or all of the information provided on this EDS and any attachments to this EDS may be made available to the public on the Internet, in response to a Freedom of Information Act request, or otherwise. By completing and signing this EDS, the Disclosing Party waives and releases any possible rights or claims which it may have against the City in connection with the public release of information contained in this EDS and also authorizes the City to verify the accuracy of any information submitted in this EDS.

E. The information provided in this EDS must be kept current. In the event of changes, the Disclosing Party must supplement this EDS up to the time the City takes action on the Matter. If the Matter is a contract being handled by the City's Department of Procurement Services, the Disclosing Party must update this EDS as the contract requires. **NOTE:** With respect to Matters subject to Article I of Chapter 1-23 of the Municipal Code (imposing **PERMANENT INELIGIBILITY** for certain specified offenses), the information provided herein regarding eligibility must be kept current for a longer period, as required by Chapter 1-23 and Section 2-154-020 of the Municipal Code.

The Disclosing Party represents and warrants that:

F.1. The Disclosing Party is not delinquent in the payment of any tax administered by the Illinois Department of Revenue, nor are the Disclosing Party or its Affiliated Entities delinquent in paying any fine, fee, tax or other charge owed to the City. This includes, but is not limited to, all water charges, sewer charges, license fees, parking tickets, property taxes or sales taxes.

F.2 If the Disclosing Party is the Applicant, the Disclosing Party and its Affiliated Entities will not use, nor permit their subcontractors to use, any facility listed by the U.S. E.P.A. on the federal Excluded Parties List System ("EPLS") maintained by the U. S. General Services Administration.

F.3 If the Disclosing Party is the Applicant, the Disclosing Party will obtain from any contractors/subcontractors hired or to be hired in connection with the Matter certifications equal in form and substance to those in F.1. and F.2. above and will not, without the prior written consent of the City, use any such contractor/subcontractor that does not provide such certifications or that the Disclosing Party has reason to believe has not provided or cannot provide truthful certifications.

NOTE: If the Disclosing Party cannot certify as to any of the items in F.1., F.2. or F.3. above, an explanatory statement must be attached to this EDS.

**CERTIFICATION**

Under penalty of perjury, the person signing below: (1) warrants that he/she is authorized to execute this EDS and Appendix A (if applicable) on behalf of the Disclosing Party, and (2) warrants that all certifications and statements contained in this EDS and Appendix A (if applicable) are true, accurate and complete as of the date furnished to the City.

NOAH PROPERTIES LLC  
(Print or type name of Disclosing Party)

By: [Signature]  
(Sign here)

BART PRZYJEMSKI  
(Print or type name of person signing)

MANAGER  
(Print or type title of person signing)

Signed and sworn to before me on (date) 9-6-2016,  
at Cook County, IL (state).

[Signature] Notary Public.

Commission expires: 9-28-2020.

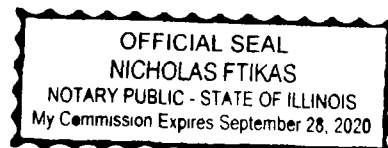

1. The first part of the document is a list of names and addresses of the members of the committee.

2. The second part of the document is a list of names and addresses of the members of the committee.

3. The third part of the document is a list of names and addresses of the members of the committee.

4. The fourth part of the document is a list of names and addresses of the members of the committee.

5. The fifth part of the document is a list of names and addresses of the members of the committee.

6. The sixth part of the document is a list of names and addresses of the members of the committee.

7. The seventh part of the document is a list of names and addresses of the members of the committee.

**CITY OF CHICAGO  
ECONOMIC DISCLOSURE STATEMENT AND AFFIDAVIT  
APPENDIX A**

**FAMILIAL RELATIONSHIPS WITH ELECTED CITY OFFICIALS AND DEPARTMENT HEADS**

**This Appendix is to be completed only by (a) the Applicant, and (b) any legal entity which has a direct ownership interest in the Applicant exceeding 7.5 percent. It is not to be completed by any legal entity which has only an indirect ownership interest in the Applicant.**

Under Municipal Code Section 2-154-015, the Disclosing Party must disclose whether such Disclosing Party or any "Applicable Party" or any Spouse or Domestic Partner thereof currently has a "familial relationship" with any elected city official or department head. A "familial relationship" exists if, as of the date this EDS is signed, the Disclosing Party or any "Applicable Party" or any Spouse or Domestic Partner thereof is related to the mayor, any alderman, the city clerk, the city treasurer or any city department head as spouse or domestic partner or as any of the following, whether by blood or adoption: parent, child, brother or sister, aunt or uncle, niece or nephew, grandparent, grandchild, father-in-law, mother-in-law, son-in-law, daughter-in-law, stepfather or stepmother, stepson or stepdaughter, stepbrother or stepsister or half-brother or half-sister.

"Applicable Party" means (1) all executive officers of the Disclosing Party listed in Section II.B.1.a., if the Disclosing Party is a corporation; all partners of the Disclosing Party, if the Disclosing Party is a general partnership; all general partners and limited partners of the Disclosing Party, if the Disclosing Party is a limited partnership; all managers, managing members and members of the Disclosing Party, if the Disclosing Party is a limited liability company; (2) all principal officers of the Disclosing Party; and (3) any person having more than a 7.5 percent ownership interest in the Disclosing Party. "Principal officers" means the president, chief operating officer, executive director, chief financial officer, treasurer or secretary of a legal entity or any person exercising similar authority.

Does the Disclosing Party or any "Applicable Party" or any Spouse or Domestic Partner thereof currently have a "familial relationship" with an elected city official or department head?

Yes

No

If yes, please identify below (1) the name and title of such person, (2) the name of the legal entity to which such person is connected; (3) the name and title of the elected city official or department head to whom such person has a familial relationship, and (4) the precise nature of such familial relationship.

---

---

---

**CITY OF CHICAGO  
ECONOMIC DISCLOSURE STATEMENT AND AFFIDAVIT  
APPENDIX B**

**BUILDING CODE SCOFFLAW/PROBLEM LANDLORD CERTIFICATION**

**This Appendix is to be completed only by (a) the Applicant, and (b) any legal entity which has a direct ownership interest in the Applicant exceeding 7.5 percent (an “Owner”). It is not to be completed by any legal entity which has only an indirect ownership interest in the Applicant.**

1. Pursuant to Municipal Code Section 2-154-010, is the Applicant or any Owner identified as a building code scofflaw or problem landlord pursuant to Section 2-92-416 of the Municipal Code?

Yes

No

2. If the Applicant is a legal entity publicly traded on any exchange, is any officer or director of the Applicant identified as a building code scofflaw or problem landlord pursuant to Section 2-92-416 of the Municipal Code?

Yes

No

Not Applicable

3. If yes to (1) or (2) above, please identify below the name of the person or legal entity identified as a building code scofflaw or problem landlord and the address of the building or buildings to which the pertinent code violations apply.

---

---

---

**FILLING OUT THIS APPENDIX B CONSTITUTES ACKNOWLEDGMENT AND AGREEMENT THAT THIS APPENDIX B IS INCORPORATED BY REFERENCE INTO, AND MADE A PART OF, THE ASSOCIATED EDS, AND THAT THE REPRESENTATIONS MADE IN THIS APPENDIX B ARE SUBJECT TO THE CERTIFICATION MADE UNDER PENALTY OF PERJURY ON PAGE 12 OF THE ASSOCIATED EDS.**

To whom it may concern:

I, Robertino Presta, Manager of 2601 Harlem, LLC, an Illinois limited liability company, Owner of property located at 2601-03 N. Harlem Ave., Chicago, IL, authorize the Law Offices of Samuel V.P. Banks to file a zoning amendment application on behalf of the Contract purchaser and Applicant, Noah Properties, LLC, with the City of Chicago for that property.



---

Robertino Presta  
2601 Harlem, LLC

CITY OF CHICAGO  
ECONOMIC DISCLOSURE STATEMENT  
AND AFFIDAVIT

SECTION I -- GENERAL INFORMATION

A. Legal name of the Disclosing Party submitting this EDS. Include d/b/a/ if applicable:

2601 Harlem LLC

Check ONE of the following three boxes:

Indicate whether the Disclosing Party submitting this EDS is:

1.  the Applicant - PROPERTY OWNER  
OR

2.  a legal entity holding a direct or indirect interest in the Applicant. State the legal name of the Applicant in which the Disclosing Party holds an interest: \_\_\_\_\_  
OR

3.  a legal entity with a right of control (see Section II.B.1.) State the legal name of the entity in which the Disclosing Party holds a right of control: \_\_\_\_\_

B. Business address of the Disclosing Party: 520 E. NORTH AVE.  
CAROL STREAM, IL 60188

C. Telephone: 312-782-1983 Fax: 312-782-2433 Email: nick@sambarkeslaw.com

D. Name of contact person: DELLORAS FITEAS - APPLICANT'S ATTORNEY

E. Federal Employer Identification No. (if you have one): \_\_\_\_\_

F. Brief description of contract, transaction or other undertaking (referred to below as the "Matter") to which this EDS pertains. (Include project number and location of property, if applicable):

ZONING AMENDMENT FOR 2601-2619 N. HARLEM

G. Which City agency or department is requesting this EDS? DPD / COZ

If the Matter is a contract being handled by the City's Department of Procurement Services, please complete the following:

Specification # \_\_\_\_\_ and Contract # \_\_\_\_\_

**SECTION II -- DISCLOSURE OF OWNERSHIP INTERESTS**

**A. NATURE OF THE DISCLOSING PARTY**

1. Indicate the nature of the Disclosing Party:

- Person
- Limited liability company
- Publicly registered business corporation
- Limited liability partnership
- Privately held business corporation
- Joint venture
- Sole proprietorship
- Not-for-profit corporation
- General partnership
- (Is the not-for-profit corporation also a 501(c)(3))?
- Limited partnership
- Yes  No
- Trust
- Other (please specify)

2. For legal entities, the state (or foreign country) of incorporation or organization, if applicable:

ILLINOIS

3. For legal entities not organized in the State of Illinois: Has the organization registered to do business in the State of Illinois as a foreign entity?

- Yes
- No
- N/A

**B. IF THE DISCLOSING PARTY IS A LEGAL ENTITY:**

1. List below the full names and titles of all executive officers and all directors of the entity.

**NOTE:** For not-for-profit corporations, also list below all members, if any, which are legal entities. If there are no such members, write "no members." For trusts, estates or other similar entities, list below the legal titleholder(s).

If the entity is a general partnership, limited partnership, limited liability company, limited liability partnership or joint venture, list below the name and title of each general partner, managing member, manager or any other person or entity that controls the day-to-day management of the Disclosing Party.

**NOTE:** Each legal entity listed below must submit an EDS on its own behalf.

Name	Title
<u>ROBERTINO PRESTA</u>	<u>Manager</u>
<u>ANTONELLA PRESTA</u>	<u>Manager</u>

2. Please provide the following information concerning each person or entity having a direct or indirect beneficial interest (including ownership) in excess of 7.5% of the Disclosing Party. Examples of such an interest include shares in a corporation, partnership interest in a partnership or joint venture,



interest of a member or manager in a limited liability company, or interest of a beneficiary of a trust, estate or other similar entity. If none, state "None." NOTE: Pursuant to Section 2-154-030 of the Municipal Code of Chicago ("Municipal Code"), the City may require any such additional information from any applicant which is reasonably intended to achieve full disclosure.

Name	Business Address	Percentage Interest in the Disclosing Party
ROBERTINO PRESTA	570 E. North Ave	50%
ANTONELLA PRESTA	Carol Stream, IL	50%
60185		

**SECTION III -- BUSINESS RELATIONSHIPS WITH CITY ELECTED OFFICIALS**

Has the Disclosing Party had a "business relationship," as defined in Chapter 2-156 of the Municipal Code, with any City elected official in the 12 months before the date this EDS is signed?

Yes                       No

If yes, please identify below the name(s) of such City elected official(s) and describe such relationship(s):

N/A

**SECTION IV -- DISCLOSURE OF SUBCONTRACTORS AND OTHER RETAINED PARTIES**

The Disclosing Party must disclose the name and business address of each subcontractor, attorney, lobbyist, accountant, consultant and any other person or entity whom the Disclosing Party has retained or expects to retain in connection with the Matter, as well as the nature of the relationship, and the total amount of the fees paid or estimated to be paid. The Disclosing Party is not required to disclose employees who are paid solely through the Disclosing Party's regular payroll.

“Lobbyist” means any person or entity who undertakes to influence any legislative or administrative action on behalf of any person or entity other than: (1) a not-for-profit entity, on an unpaid basis, or (2) himself. “Lobbyist” also means any person or entity any part of whose duties as an employee of another includes undertaking to influence any legislative or administrative action.

If the Disclosing Party is uncertain whether a disclosure is required under this Section, the Disclosing Party must either ask the City whether disclosure is required or make the disclosure.

Name (indicate whether retained or anticipated to be retained)	Business Address	Relationship to Disclosing Party (subcontractor, attorney, lobbyist, etc.)	Fees (indicate whether paid or estimated.) <b>NOTE:</b> "hourly rate" or "t.b.d." is not an acceptable response.
--	------------------	--	--

ATTORNEY

RETAINED BY

APPLICANT

(Add sheets if necessary)

Check here if the Disclosing Party has not retained, nor expects to retain, any such persons or entities.

**SECTION V -- CERTIFICATIONS**

**A. COURT-ORDERED CHILD SUPPORT COMPLIANCE**

Under Municipal Code Section 2-92-415, substantial owners of business entities that contract with the City must remain in compliance with their child support obligations throughout the contract's term.

Has any person who directly or indirectly owns 10% or more of the Disclosing Party been declared in arrearage on any child support obligations by any Illinois court of competent jurisdiction?

Yes       No       No person directly or indirectly owns 10% or more of the Disclosing Party.

If "Yes," has the person entered into a court-approved agreement for payment of all support owed and is the person in compliance with that agreement?

Yes       No

**B. FURTHER CERTIFICATIONS**

1. Pursuant to Municipal Code Chapter 1-23, Article I ("Article I")(which the Applicant should consult for defined terms (e.g., "doing business") and legal requirements), if the Disclosing Party submitting this EDS is the Applicant and is doing business with the City, then the Disclosing Party certifies as follows: (i) neither the Applicant nor any controlling person is currently indicted or charged with, or has admitted guilt of, or has ever been convicted of, or placed under supervision for, any criminal offense involving actual, attempted, or conspiracy to commit bribery, theft, fraud, forgery, perjury, dishonesty or deceit against an officer or employee of the City or any sister agency; and (ii) the Applicant understands and acknowledges that compliance with Article I is a continuing requirement for doing business with the City. **NOTE:** If Article I applies to the Applicant, the permanent compliance timeframe in Article I supersedes some five-year compliance timeframes in certifications 2 and 3 below.

2. The Disclosing Party and, if the Disclosing Party is a legal entity, all of those persons or entities identified in Section II.B.1. of this EDS:
- a. are not presently debarred, suspended, proposed for debarment, declared ineligible or voluntarily excluded from any transactions by any federal, state or local unit of government;
  - b. have not, within a five-year period preceding the date of this EDS, been convicted of a criminal offense, adjudged guilty, or had a civil judgment rendered against them in connection with: obtaining, attempting to obtain, or performing a public (federal, state or local) transaction or contract under a public transaction; a violation of federal or state antitrust statutes; fraud; embezzlement; theft; forgery; bribery; falsification or destruction of records; making false statements; or receiving stolen property;
  - c. are not presently indicted for, or criminally or civilly charged by, a governmental entity (federal, state or local) with committing any of the offenses set forth in clause B.2.b. of this Section V;
  - d. have not, within a five-year period preceding the date of this EDS, had one or more public transactions (federal, state or local) terminated for cause or default; and
  - e. have not, within a five-year period preceding the date of this EDS, been convicted, adjudged guilty, or found liable in a civil proceeding, or in any criminal or civil action, including actions concerning environmental violations, instituted by the City or by the federal government, any state, or any other unit of local government.
3. The certifications in subparts 3, 4 and 5 concern:
- the Disclosing Party;
  - any "Contractor" (meaning any contractor or subcontractor used by the Disclosing Party in connection with the Matter, including but not limited to all persons or legal entities disclosed under Section IV, "Disclosure of Subcontractors and Other Retained Parties");
  - any "Affiliated Entity" (meaning a person or entity that, directly or indirectly: controls the Disclosing Party, is controlled by the Disclosing Party, or is, with the Disclosing Party, under common control of another person or entity. Indicia of control include, without limitation: interlocking management or ownership; identity of interests among family members, shared facilities and equipment; common use of employees; or organization of a business entity following the ineligibility of a business entity to do business with federal or state or local government, including the City, using substantially the same management, ownership, or principals as the ineligible entity); with respect to Contractors, the term Affiliated Entity means a person or entity that directly or indirectly controls the Contractor, is controlled by it, or, with the Contractor, is under common control of another person or entity;
  - any responsible official of the Disclosing Party, any Contractor or any Affiliated Entity or any other official, agent or employee of the Disclosing Party, any Contractor or any Affiliated Entity, acting pursuant to the direction or authorization of a responsible official of the Disclosing Party, any Contractor or any Affiliated Entity (collectively "Agents").

Neither the Disclosing Party, nor any Contractor, nor any Affiliated Entity of either the Disclosing Party or any Contractor nor any Agents have, during the five years before the date this EDS is signed, or, with respect to a Contractor, an Affiliated Entity, or an Affiliated Entity of a Contractor during the five years before the date of such Contractor's or Affiliated Entity's contract or engagement in connection with the Matter:

- a. bribed or attempted to bribe, or been convicted or adjudged guilty of bribery or attempting to bribe, a public officer or employee of the City, the State of Illinois, or any agency of the federal government or of any state or local government in the United States of America, in that officer's or employee's official capacity;
- b. agreed or colluded with other bidders or prospective bidders, or been a party to any such agreement, or been convicted or adjudged guilty of agreement or collusion among bidders or prospective bidders, in restraint of freedom of competition by agreement to bid a fixed price or otherwise; or
- c. made an admission of such conduct described in a. or b. above that is a matter of record, but have not been prosecuted for such conduct; or
- d. violated the provisions of Municipal Code Section 2-92-610 (Living Wage Ordinance).

4. Neither the Disclosing Party, Affiliated Entity or Contractor, or any of their employees, officials, agents or partners, is barred from contracting with any unit of state or local government as a result of engaging in or being convicted of (1) bid-rigging in violation of 720 ILCS 5/33E-3; (2) bid-rotating in violation of 720 ILCS 5/33E-4; or (3) any similar offense of any state or of the United States of America that contains the same elements as the offense of bid-rigging or bid-rotating.

5. Neither the Disclosing Party nor any Affiliated Entity is listed on any of the following lists maintained by the Office of Foreign Assets Control of the U.S. Department of the Treasury or the Bureau of Industry and Security of the U.S. Department of Commerce or their successors: the Specially Designated Nationals List, the Denied Persons List, the Unverified List, the Entity List and the Debarred List.

6. The Disclosing Party understands and shall comply with the applicable requirements of Chapters 2-55 (Legislative Inspector General), 2-56 (Inspector General) and 2-156 (Governmental Ethics) of the Municipal Code.

7. If the Disclosing Party is unable to certify to any of the above statements in this Part B (Further Certifications), the Disclosing Party must explain below:

\_\_\_\_\_ N/A \_\_\_\_\_  
\_\_\_\_\_  
\_\_\_\_\_

If the letters "NA," the word "None," or no response appears on the lines above, it will be conclusively presumed that the Disclosing Party certified to the above statements.

8. To the best of the Disclosing Party's knowledge after reasonable inquiry, the following is a complete list of all current employees of the Disclosing Party who were, at any time during the 12-month period preceding the execution date of this EDS, an employee, or elected or appointed official, of the City of Chicago (if none, indicate with "N/A" or "none").

N/A

9. To the best of the Disclosing Party's knowledge after reasonable inquiry, the following is a complete list of all gifts that the Disclosing Party has given or caused to be given, at any time during the 12-month period preceding the execution date of this EDS, to an employee, or elected or appointed official, of the City of Chicago. For purposes of this statement, a "gift" does not include: (i) anything made generally available to City employees or to the general public, or (ii) food or drink provided in the course of official City business and having a retail value of less than \$20 per recipient (if none, indicate with "N/A" or "none"). As to any gift listed below, please also list the name of the City recipient.

N/A

C. CERTIFICATION OF STATUS AS FINANCIAL INSTITUTION

1. The Disclosing Party certifies that the Disclosing Party (check one)

is  is not

a "financial institution" as defined in Section 2-32-455(b) of the Municipal Code.

2. If the Disclosing Party IS a financial institution, then the Disclosing Party pledges:

"We are not and will not become a predatory lender as defined in Chapter 2-32 of the Municipal Code. We further pledge that none of our affiliates is, and none of them will become, a predatory lender as defined in Chapter 2-32 of the Municipal Code. We understand that becoming a predatory lender or becoming an affiliate of a predatory lender may result in the loss of the privilege of doing business with the City."

If the Disclosing Party is unable to make this pledge because it or any of its affiliates (as defined in Section 2-32-455(b) of the Municipal Code) is a predatory lender within the meaning of Chapter 2-32 of the Municipal Code, explain here (attach additional pages if necessary):

N/A

---

If the letters "NA," the word "None," or no response appears on the lines above, it will be conclusively presumed that the Disclosing Party certified to the above statements.

**D. CERTIFICATION REGARDING INTEREST IN CITY BUSINESS**

Any words or terms that are defined in Chapter 2-156 of the Municipal Code have the same meanings when used in this Part D.

1. In accordance with Section 2-156-110 of the Municipal Code: Does any official or employee of the City have a financial interest in his or her own name or in the name of any other person or entity in the Matter?

Yes                       No

NOTE: If you checked "Yes" to Item D.1., proceed to Items D.2. and D.3. If you checked "No" to Item D.1., proceed to Part E.

2. Unless sold pursuant to a process of competitive bidding, or otherwise permitted, no City elected official or employee shall have a financial interest in his or her own name or in the name of any other person or entity in the purchase of any property that (i) belongs to the City, or (ii) is sold for taxes or assessments, or (iii) is sold by virtue of legal process at the suit of the City (collectively, "City Property Sale"). Compensation for property taken pursuant to the City's eminent domain power does not constitute a financial interest within the meaning of this Part D.

Does the Matter involve a City Property Sale?

Yes                       No

3. If you checked "Yes" to Item D.1., provide the names and business addresses of the City officials or employees having such interest and identify the nature of such interest:

Name	Business Address	Nature of Interest
		N/A

4. The Disclosing Party further certifies that no prohibited financial interest in the Matter will be acquired by any City official or employee.

**E. CERTIFICATION REGARDING SLAVERY ERA BUSINESS**

Please check either 1. or 2. below. If the Disclosing Party checks 2., the Disclosing Party must disclose below or in an attachment to this EDS all information required by paragraph 2. Failure to

comply with these disclosure requirements may make any contract entered into with the City in connection with the Matter voidable by the City.

✓ 1. The Disclosing Party verifies that the Disclosing Party has searched any and all records of the Disclosing Party and any and all predecessor entities regarding records of investments or profits from slavery or slaveholder insurance policies during the slavery era (including insurance policies issued to slaveholders that provided coverage for damage to or injury or death of their slaves), and the Disclosing Party has found no such records.

     2. The Disclosing Party verifies that, as a result of conducting the search in step 1 above, the Disclosing Party has found records of investments or profits from slavery or slaveholder insurance policies. The Disclosing Party verifies that the following constitutes full disclosure of all such records, including the names of any and all slaves or slaveholders described in those records:

\_\_\_\_\_  
\_\_\_\_\_  
\_\_\_\_\_ N/A \_\_\_\_\_  
\_\_\_\_\_

**SECTION VI -- CERTIFICATIONS FOR FEDERALLY FUNDED MATTERS**

**NOTE: If the Matter is federally funded, complete this Section VI. If the Matter is not federally funded, proceed to Section VII. For purposes of this Section VI, tax credits allocated by the City and proceeds of debt obligations of the City are not federal funding.**

**A. CERTIFICATION REGARDING LOBBYING**

1. List below the names of all persons or entities registered under the federal Lobbying Disclosure Act of 1995 who have made lobbying contacts on behalf of the Disclosing Party with respect to the Matter: (Add sheets if necessary):

\_\_\_\_\_  
\_\_\_\_\_ N/A \_\_\_\_\_  
\_\_\_\_\_

(If no explanation appears or begins on the lines above, or if the letters "NA" or if the word "None" appear, it will be conclusively presumed that the Disclosing Party means that NO persons or entities registered under the Lobbying Disclosure Act of 1995 have made lobbying contacts on behalf of the Disclosing Party with respect to the Matter.)

2. The Disclosing Party has not spent and will not expend any federally appropriated funds to pay any person or entity listed in Paragraph A.1. above for his or her lobbying activities or to pay any person or entity to influence or attempt to influence an officer or employee of any agency, as defined by applicable federal law, a member of Congress, an officer or employee of Congress, or an employee of a member of Congress, in connection with the award of any federally funded contract, making any federally funded grant or loan, entering into any cooperative agreement, or to extend, continue, renew, amend, or modify any federally funded contract, grant, loan, or cooperative agreement.

3. The Disclosing Party will submit an updated certification at the end of each calendar quarter in which there occurs any event that materially affects the accuracy of the statements and information set forth in paragraphs A.1. and A.2. above.

4. The Disclosing Party certifies that either: (i) it is not an organization described in section 501(c)(4) of the Internal Revenue Code of 1986; or (ii) it is an organization described in section 501(c)(4) of the Internal Revenue Code of 1986 but has not engaged and will not engage in "Lobbying Activities".

5. If the Disclosing Party is the Applicant, the Disclosing Party must obtain certifications equal in form and substance to paragraphs A.1. through A.4. above from all subcontractors before it awards any subcontract and the Disclosing Party must maintain all such subcontractors' certifications for the duration of the Matter and must make such certifications promptly available to the City upon request.

#### B. CERTIFICATION REGARDING EQUAL EMPLOYMENT OPPORTUNITY

If the Matter is federally funded, federal regulations require the Applicant and all proposed subcontractors to submit the following information with their bids or in writing at the outset of negotiations. *N/A*

Is the Disclosing Party the Applicant?

Yes  No

If "Yes," answer the three questions below:

1. Have you developed and do you have on file affirmative action programs pursuant to applicable federal regulations? (See 41 CFR Part 60-2.)

Yes  No

2. Have you filed with the Joint Reporting Committee, the Director of the Office of Federal Contract Compliance Programs, or the Equal Employment Opportunity Commission all reports due under the applicable filing requirements?

Yes  No

3. Have you participated in any previous contracts or subcontracts subject to the equal opportunity clause?

Yes  No

If you checked "No" to question 1. or 2. above, please provide an explanation:

*N/A*



**SECTION VII -- ACKNOWLEDGMENTS, CONTRACT INCORPORATION, COMPLIANCE, PENALTIES, DISCLOSURE**

The Disclosing Party understands and agrees that:

A. The certifications, disclosures, and acknowledgments contained in this EDS will become part of any contract or other agreement between the Applicant and the City in connection with the Matter, whether procurement, City assistance, or other City action, and are material inducements to the City's execution of any contract or taking other action with respect to the Matter. The Disclosing Party understands that it must comply with all statutes, ordinances, and regulations on which this EDS is based.

B. The City's Governmental Ethics and Campaign Financing Ordinances, Chapters 2-156 and 2-164 of the Municipal Code, impose certain duties and obligations on persons or entities seeking City contracts, work, business, or transactions. The full text of these ordinances and a training program is available on line at [www.cityofchicago.org/Ethics](http://www.cityofchicago.org/Ethics), and may also be obtained from the City's Board of Ethics, 740 N.

Sedgwick St., Suite 500, Chicago, IL 60610, (312) 744-9660. The Disclosing Party must comply fully with the applicable ordinances.

C. If the City determines that any information provided in this EDS is false, incomplete or inaccurate, any contract or other agreement in connection with which it is submitted may be rescinded or be void or voidable, and the City may pursue any remedies under the contract or agreement (if not rescinded or void), at law, or in equity, including terminating the Disclosing Party's participation in the Matter and/or declining to allow the Disclosing Party to participate in other transactions with the City. Remedies at law for a false statement of material fact may include incarceration and an award to the City of treble damages.

D. It is the City's policy to make this document available to the public on its Internet site and/or upon request. Some or all of the information provided on this EDS and any attachments to this EDS may be made available to the public on the Internet, in response to a Freedom of Information Act request, or otherwise. By completing and signing this EDS, the Disclosing Party waives and releases any possible rights or claims which it may have against the City in connection with the public release of information contained in this EDS and also authorizes the City to verify the accuracy of any information submitted in this EDS.

E. The information provided in this EDS must be kept current. In the event of changes, the Disclosing Party must supplement this EDS up to the time the City takes action on the Matter. If the Matter is a contract being handled by the City's Department of Procurement Services, the Disclosing Party must update this EDS as the contract requires. **NOTE:** With respect to Matters subject to Article I of Chapter 1-23 of the Municipal Code (imposing **PERMANENT INELIGIBILITY** for certain specified offenses), the information provided herein regarding eligibility must be kept current for a longer period, as required by Chapter 1-23 and Section 2-154-020 of the Municipal Code.

The Disclosing Party represents and warrants that:

F.1. The Disclosing Party is not delinquent in the payment of any tax administered by the Illinois Department of Revenue, nor are the Disclosing Party or its Affiliated Entities delinquent in paying any fine, fee, tax or other charge owed to the City. This includes, but is not limited to, all water charges, sewer charges, license fees, parking tickets, property taxes or sales taxes.

F.2 If the Disclosing Party is the Applicant, the Disclosing Party and its Affiliated Entities will not use, nor permit their subcontractors to use, any facility listed by the U.S. E.P.A. on the federal Excluded Parties List System ("EPLS") maintained by the U. S. General Services Administration.

F.3 If the Disclosing Party is the Applicant, the Disclosing Party will obtain from any contractors/subcontractors hired or to be hired in connection with the Matter certifications equal in form and substance to those in F.1. and F.2. above and will not, without the prior written consent of the City, use any such contractor/subcontractor that does not provide such certifications or that the Disclosing Party has reason to believe has not provided or cannot provide truthful certifications.

NOTE: If the Disclosing Party cannot certify as to any of the items in F.1., F.2. or F.3. above, an explanatory statement must be attached to this EDS.

**CERTIFICATION**

Under penalty of perjury, the person signing below: (1) warrants that he/she is authorized to execute this EDS and Appendix A (if applicable) on behalf of the Disclosing Party, and (2) warrants that all certifications and statements contained in this EDS and Appendix A (if applicable) are true, accurate and complete as of the date furnished to the City.

2601 Harlem LLC  
(Print or type name of Disclosing Party)

By: \_\_\_\_\_  
(Sign here)

ROBERTINO PRESTA  
(Print or type name of person signing)

Manager  
(Print or type title of person signing)

Signed and sworn to before me on (date) 9-8-2016  
at DU PAGE County, IL (state).

James R. Iovino Notary Public.  
Commission expires: 8-13-2017

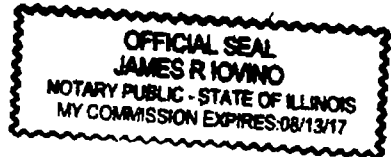

**CITY OF CHICAGO  
ECONOMIC DISCLOSURE STATEMENT AND AFFIDAVIT  
APPENDIX A**

**FAMILIAL RELATIONSHIPS WITH ELECTED CITY OFFICIALS AND DEPARTMENT HEADS**

**This Appendix is to be completed only by (a) the Applicant, and (b) any legal entity which has a direct ownership interest in the Applicant exceeding 7.5 percent. It is not to be completed by any legal entity which has only an indirect ownership interest in the Applicant.**

Under Municipal Code Section 2-154-015, the Disclosing Party must disclose whether such Disclosing Party or any "Applicable Party" or any Spouse or Domestic Partner thereof currently has a "familial relationship" with any elected city official or department head. A "familial relationship" exists if, as of the date this EDS is signed, the Disclosing Party or any "Applicable Party" or any Spouse or Domestic Partner thereof is related to the mayor, any alderman, the city clerk, the city treasurer or any city department head as spouse or domestic partner or as any of the following, whether by blood or adoption: parent, child, brother or sister, aunt or uncle, niece or nephew, grandparent, grandchild, father-in-law, mother-in-law, son-in-law, daughter-in-law, stepfather or stepmother, stepson or stepdaughter, stepbrother or stepsister or half-brother or half-sister.

"Applicable Party" means (1) all executive officers of the Disclosing Party listed in Section II.B.1.a., if the Disclosing Party is a corporation; all partners of the Disclosing Party, if the Disclosing Party is a general partnership; all general partners and limited partners of the Disclosing Party, if the Disclosing Party is a limited partnership; all managers, managing members and members of the Disclosing Party, if the Disclosing Party is a limited liability company; (2) all principal officers of the Disclosing Party; and (3) any person having more than a 7.5 percent ownership interest in the Disclosing Party. "Principal officers" means the president, chief operating officer, executive director, chief financial officer, treasurer or secretary of a legal entity or any person exercising similar authority.

Does the Disclosing Party or any "Applicable Party" or any Spouse or Domestic Partner thereof currently have a "familial relationship" with an elected city official or department head?

Yes

No

If yes, please identify below (1) the name and title of such person, (2) the name of the legal entity to which such person is connected; (3) the name and title of the elected city official or department head to whom such person has a familial relationship, and (4) the precise nature of such familial relationship.

\_\_\_\_\_  
\_\_\_\_\_  
\_\_\_\_\_ *N/A*

**CITY OF CHICAGO  
ECONOMIC DISCLOSURE STATEMENT AND AFFIDAVIT  
APPENDIX B**

**BUILDING CODE SCOFFLAW/PROBLEM LANDLORD CERTIFICATION**

**This Appendix is to be completed only by (a) the Applicant, and (b) any legal entity which has a direct ownership interest in the Applicant exceeding 7.5 percent (an "Owner"). It is not to be completed by any legal entity which has only an indirect ownership interest in the Applicant.**

1. Pursuant to Municipal Code Section 2-154-010, is the Applicant or any Owner identified as a building code scofflaw or problem landlord pursuant to Section 2-92-416 of the Municipal Code?

Yes

No

2. If the Applicant is a legal entity publicly traded on any exchange, is any officer or director of the Applicant identified as a building code scofflaw or problem landlord pursuant to Section 2-92-416 of the Municipal Code?

Yes

No

Not Applicable

3. If yes to (1) or (2) above, please identify below the name of the person or legal entity identified as a building code scofflaw or problem landlord and the address of the building or buildings to which the pertinent code violations apply.

N/A

---

---

---

**FILLING OUT THIS APPENDIX B CONSTITUTES ACKNOWLEDGMENT AND AGREEMENT THAT THIS APPENDIX B IS INCORPORATED BY REFERENCE INTO, AND MADE A PART OF, THE ASSOCIATED EDS, AND THAT THE REPRESENTATIONS MADE IN THIS APPENDIX B ARE SUBJECT TO THE CERTIFICATION MADE UNDER PENALTY OF PERJURY ON PAGE 12 OF THE ASSOCIATED EDS.**

To whom it may concern:

I, Robertino Presta, Manager of 2605 Harlem, LLC, an Illinois limited liability company, Owner of property located at 2605-19 N. Harlem Ave., Chicago, IL, authorize the Law Offices of Samuel V.P. Banks to file a zoning amendment application on behalf of the Contract purchaser and Applicant, Noah Properties, LLC, with the City of Chicago for that property.



---

Robertino Presta  
2605 Harlem, LLC

CITY OF CHICAGO  
ECONOMIC DISCLOSURE STATEMENT  
AND AFFIDAVIT

SECTION I -- GENERAL INFORMATION

A. Legal name of the Disclosing Party submitting this EDS. Include d/b/a/ if applicable:

2605 HARLEM LLC

Check ONE of the following three boxes:

Indicate whether the Disclosing Party submitting this EDS is:

1.  the Applicant - PROPERTY OWNER  
OR

2.  a legal entity holding a direct or indirect interest in the Applicant. State the legal name of the Applicant in which the Disclosing Party holds an interest: \_\_\_\_\_  
OR

3.  a legal entity with a right of control (see Section II.B.1.) State the legal name of the entity in which the Disclosing Party holds a right of control: \_\_\_\_\_

B. Business address of the Disclosing Party: 520 E. NORTH AVE.  
CAROL STREAM, IL 60188

C. Telephone: 312-782-1983 Fax: 312-782-2433 Email: nick@sawbankslaw.com

D. Name of contact person: NICHOLAS FEEKS - APPLICANT'S ATTORNEY

E. Federal Employer Identification No. (if you have one): \_\_\_\_\_

F. Brief description of contract, transaction or other undertaking (referred to below as the "Matter") to which this EDS pertains. (Include project number and location of property, if applicable):

ZONING AMENDMENT FOR 2601-2619 N. HARLEM

G. Which City agency or department is requesting this EDS? DPD | COZ

If the Matter is a contract being handled by the City's Department of Procurement Services, please complete the following:

Specification # \_\_\_\_\_ and Contract # \_\_\_\_\_

**SECTION II -- DISCLOSURE OF OWNERSHIP INTERESTS**

**A. NATURE OF THE DISCLOSING PARTY**

1. Indicate the nature of the Disclosing Party:

- Person
- Limited liability company
- Publicly registered business corporation
- Limited liability partnership
- Privately held business corporation
- Joint venture
- Sole proprietorship
- Not-for-profit corporation
- General partnership
- (Is the not-for-profit corporation also a 501(c)(3))?
- Limited partnership
- Yes  No
- Trust
- Other (please specify)

2. For legal entities, the state (or foreign country) of incorporation or organization, if applicable:

ILLINOIS

3. For legal entities not organized in the State of Illinois: Has the organization registered to do business in the State of Illinois as a foreign entity?

- Yes
- No
- N/A

**B. IF THE DISCLOSING PARTY IS A LEGAL ENTITY:**

1. List below the full names and titles of all executive officers and all directors of the entity.

**NOTE:** For not-for-profit corporations, also list below all members, if any, which are legal entities. If there are no such members, write "no members." For trusts, estates or other similar entities, list below the legal titleholder(s).

If the entity is a general partnership, limited partnership, limited liability company, limited liability partnership or joint venture, list below the name and title of each general partner, managing member, manager or any other person or entity that controls the day-to-day management of the Disclosing Party.

**NOTE:** Each legal entity listed below must submit an EDS on its own behalf.

Name

Title

ROBERTINO PRESTA

Manager

ANTONELLA PRESTA

Manager

2. Please provide the following information concerning each person or entity having a direct or indirect beneficial interest (including ownership) in excess of 7.5% of the Disclosing Party. Examples of such an interest include shares in a corporation, partnership interest in a partnership or joint venture,

interest of a member or manager in a limited liability company, or interest of a beneficiary of a trust, estate or other similar entity. If none, state "None." NOTE: Pursuant to Section 2-154-030 of the Municipal Code of Chicago ("Municipal Code"), the City may require any such additional information from any applicant which is reasonably intended to achieve full disclosure.

Name	Business Address	Percentage Interest in the Disclosing Party
ROBERTINO PRESTA	570 E. North Ave	50%
ANTONELLA PRESTA	Carol Stream, IL	50%
60185		

**SECTION III -- BUSINESS RELATIONSHIPS WITH CITY ELECTED OFFICIALS**

Has the Disclosing Party had a "business relationship," as defined in Chapter 2-156 of the Municipal Code, with any City elected official in the 12 months before the date this EDS is signed?

Yes                       No

If yes, please identify below the name(s) of such City elected official(s) and describe such relationship(s):

N/A

**SECTION IV -- DISCLOSURE OF SUBCONTRACTORS AND OTHER RETAINED PARTIES**

The Disclosing Party must disclose the name and business address of each subcontractor, attorney, lobbyist, accountant, consultant and any other person or entity whom the Disclosing Party has retained or expects to retain in connection with the Matter, as well as the nature of the relationship, and the total amount of the fees paid or estimated to be paid. The Disclosing Party is not required to disclose employees who are paid solely through the Disclosing Party's regular payroll.

"Lobbyist" means any person or entity who undertakes to influence any legislative or administrative action on behalf of any person or entity other than: (1) a not-for-profit entity, on an unpaid basis, or (2) himself. "Lobbyist" also means any person or entity any part of whose duties as an employee of another includes undertaking to influence any legislative or administrative action.

If the Disclosing Party is uncertain whether a disclosure is required under this Section, the Disclosing Party must either ask the City whether disclosure is required or make the disclosure.



Name (indicate whether retained or anticipated to be retained)	Business Address	Relationship to Disclosing Party (subcontractor, attorney, lobbyist, etc.)	Fees (indicate whether paid or estimated.) NOTE: "hourly rate" or "t.b.d." is not an acceptable response.
--	------------------	--	---

ATTORNEY

RETAINED BY

APPLICANT

(Add sheets if necessary)

Check here if the Disclosing Party has not retained, nor expects to retain, any such persons or entities.

**SECTION V -- CERTIFICATIONS**

**A. COURT-ORDERED CHILD SUPPORT COMPLIANCE**

Under Municipal Code Section 2-92-415, substantial owners of business entities that contract with the City must remain in compliance with their child support obligations throughout the contract's term.

Has any person who directly or indirectly owns 10% or more of the Disclosing Party been declared in arrearage on any child support obligations by any Illinois court of competent jurisdiction?

Yes       No       No person directly or indirectly owns 10% or more of the Disclosing Party.

If "Yes," has the person entered into a court-approved agreement for payment of all support owed and is the person in compliance with that agreement?

Yes       No

**B. FURTHER CERTIFICATIONS**

1. Pursuant to Municipal Code Chapter 1-23, Article I ("Article I")(which the Applicant should consult for defined terms (e.g., "doing business") and legal requirements), if the Disclosing Party submitting this EDS is the Applicant and is doing business with the City, then the Disclosing Party certifies as follows: (i) neither the Applicant nor any controlling person is currently indicted or charged with, or has admitted guilt of, or has ever been convicted of, or placed under supervision for, any criminal offense involving actual, attempted, or conspiracy to commit bribery, theft, fraud, forgery, perjury, dishonesty or deceit against an officer or employee of the City or any sister agency; and (ii) the Applicant understands and acknowledges that compliance with Article I is a continuing requirement for doing business with the City. NOTE: If Article I applies to the Applicant, the permanent compliance timeframe in Article I supersedes some five-year compliance timeframes in certifications 2 and 3 below.

2. The Disclosing Party and, if the Disclosing Party is a legal entity, all of those persons or entities identified in Section II.B.1. of this EDS:

- a. are not presently debarred, suspended, proposed for debarment, declared ineligible or voluntarily excluded from any transactions by any federal, state or local unit of government;
- b. have not, within a five-year period preceding the date of this EDS, been convicted of a criminal offense, adjudged guilty, or had a civil judgment rendered against them in connection with: obtaining, attempting to obtain, or performing a public (federal, state or local) transaction or contract under a public transaction; a violation of federal or state antitrust statutes; fraud; embezzlement; theft; forgery; bribery; falsification or destruction of records; making false statements; or receiving stolen property;
- c. are not presently indicted for, or criminally or civilly charged by, a governmental entity (federal, state or local) with committing any of the offenses set forth in clause B.2.b. of this Section V;
- d. have not, within a five-year period preceding the date of this EDS, had one or more public transactions (federal, state or local) terminated for cause or default; and
- e. have not, within a five-year period preceding the date of this EDS, been convicted, adjudged guilty, or found liable in a civil proceeding, or in any criminal or civil action, including actions concerning environmental violations, instituted by the City or by the federal government, any state, or any other unit of local government.

3. The certifications in subparts 3, 4 and 5 concern:

- the Disclosing Party;
- any "Contractor" (meaning any contractor or subcontractor used by the Disclosing Party in connection with the Matter, including but not limited to all persons or legal entities disclosed under Section IV, "Disclosure of Subcontractors and Other Retained Parties");
- any "Affiliated Entity" (meaning a person or entity that, directly or indirectly: controls the Disclosing Party, is controlled by the Disclosing Party, or is, with the Disclosing Party, under common control of another person or entity. Indicia of control include, without limitation: interlocking management or ownership; identity of interests among family members, shared facilities and equipment; common use of employees; or organization of a business entity following the ineligibility of a business entity to do business with federal or state or local government, including the City, using substantially the same management, ownership, or principals as the ineligible entity); with respect to Contractors, the term Affiliated Entity means a person or entity that directly or indirectly controls the Contractor, is controlled by it, or, with the Contractor, is under common control of another person or entity;
- any responsible official of the Disclosing Party, any Contractor or any Affiliated Entity or any other official, agent or employee of the Disclosing Party, any Contractor or any Affiliated Entity, acting pursuant to the direction or authorization of a responsible official of the Disclosing Party, any Contractor or any Affiliated Entity (collectively "Agents").

Neither the Disclosing Party, nor any Contractor, nor any Affiliated Entity of either the Disclosing Party or any Contractor nor any Agents have, during the five years before the date this EDS is signed, or, with respect to a Contractor, an Affiliated Entity, or an Affiliated Entity of a Contractor during the five years before the date of such Contractor's or Affiliated Entity's contract or engagement in connection with the Matter:

- a. bribed or attempted to bribe, or been convicted or adjudged guilty of bribery or attempting to bribe, a public officer or employee of the City, the State of Illinois, or any agency of the federal government or of any state or local government in the United States of America, in that officer's or employee's official capacity;
- b. agreed or colluded with other bidders or prospective bidders, or been a party to any such agreement, or been convicted or adjudged guilty of agreement or collusion among bidders or prospective bidders, in restraint of freedom of competition by agreement to bid a fixed price or otherwise; or
- c. made an admission of such conduct described in a. or b. above that is a matter of record, but have not been prosecuted for such conduct; or
- d. violated the provisions of Municipal Code Section 2-92-610 (Living Wage Ordinance).

4. Neither the Disclosing Party, Affiliated Entity or Contractor, or any of their employees, officials, agents or partners, is barred from contracting with any unit of state or local government as a result of engaging in or being convicted of (1) bid-rigging in violation of 720 ILCS 5/33E-3; (2) bid-rotating in violation of 720 ILCS 5/33E-4; or (3) any similar offense of any state or of the United States of America that contains the same elements as the offense of bid-rigging or bid-rotating.

5. Neither the Disclosing Party nor any Affiliated Entity is listed on any of the following lists maintained by the Office of Foreign Assets Control of the U.S. Department of the Treasury or the Bureau of Industry and Security of the U.S. Department of Commerce or their successors: the Specially Designated Nationals List, the Denied Persons List, the Unverified List, the Entity List and the Debarred List.

6. The Disclosing Party understands and shall comply with the applicable requirements of Chapters 2-55 (Legislative Inspector General), 2-56 (Inspector General) and 2-156 (Governmental Ethics) of the Municipal Code.

7. If the Disclosing Party is unable to certify to any of the above statements in this Part B (Further Certifications), the Disclosing Party must explain below:

\_\_\_\_\_ N/A \_\_\_\_\_  
\_\_\_\_\_  
\_\_\_\_\_

If the letters "NA," the word "None," or no response appears on the lines above, it will be conclusively presumed that the Disclosing Party certified to the above statements.

8. To the best of the Disclosing Party's knowledge after reasonable inquiry, the following is a complete list of all current employees of the Disclosing Party who were, at any time during the 12-month period preceding the execution date of this EDS, an employee, or elected or appointed official, of the City of Chicago (if none, indicate with "N/A" or "none").

N/A

9. To the best of the Disclosing Party's knowledge after reasonable inquiry, the following is a complete list of all gifts that the Disclosing Party has given or caused to be given, at any time during the 12-month period preceding the execution date of this EDS, to an employee, or elected or appointed official, of the City of Chicago. For purposes of this statement, a "gift" does not include: (i) anything made generally available to City employees or to the general public, or (ii) food or drink provided in the course of official City business and having a retail value of less than \$20 per recipient (if none, indicate with "N/A" or "none"). As to any gift listed below, please also list the name of the City recipient.

N/A

C. CERTIFICATION OF STATUS AS FINANCIAL INSTITUTION

1. The Disclosing Party certifies that the Disclosing Party (check one)

[ ] is  is not

a "financial institution" as defined in Section 2-32-455(b) of the Municipal Code.

2. If the Disclosing Party IS a financial institution, then the Disclosing Party pledges:

"We are not and will not become a predatory lender as defined in Chapter 2-32 of the Municipal Code. We further pledge that none of our affiliates is, and none of them will become, a predatory lender as defined in Chapter 2-32 of the Municipal Code. We understand that becoming a predatory lender or becoming an affiliate of a predatory lender may result in the loss of the privilege of doing business with the City."

If the Disclosing Party is unable to make this pledge because it or any of its affiliates (as defined in Section 2-32-455(b) of the Municipal Code) is a predatory lender within the meaning of Chapter 2-32 of the Municipal Code, explain here (attach additional pages if necessary):

N/A

---

If the letters "NA," the word "None," or no response appears on the lines above, it will be conclusively presumed that the Disclosing Party certified to the above statements.

**D. CERTIFICATION REGARDING INTEREST IN CITY BUSINESS**

Any words or terms that are defined in Chapter 2-156 of the Municipal Code have the same meanings when used in this Part D.

1. In accordance with Section 2-156-110 of the Municipal Code: Does any official or employee of the City have a financial interest in his or her own name or in the name of any other person or entity in the Matter?

Yes  No

NOTE: If you checked "Yes" to Item D.1., proceed to Items D.2. and D.3. If you checked "No" to Item D.1., proceed to Part E.

2. Unless sold pursuant to a process of competitive bidding, or otherwise permitted, no City elected official or employee shall have a financial interest in his or her own name or in the name of any other person or entity in the purchase of any property that (i) belongs to the City, or (ii) is sold for taxes or assessments, or (iii) is sold by virtue of legal process at the suit of the City (collectively, "City Property Sale"). Compensation for property taken pursuant to the City's eminent domain power does not constitute a financial interest within the meaning of this Part D.

Does the Matter involve a City Property Sale?

Yes  No

3. If you checked "Yes" to Item D.1., provide the names and business addresses of the City officials or employees having such interest and identify the nature of such interest:

Name	Business Address	Nature of Interest
		N/A

4. The Disclosing Party further certifies that no prohibited financial interest in the Matter will be acquired by any City official or employee.

**E. CERTIFICATION REGARDING SLAVERY ERA BUSINESS**

Please check either 1. or 2. below. If the Disclosing Party checks 2., the Disclosing Party must disclose below or in an attachment to this EDS all information required by paragraph 2. Failure to

comply with these disclosure requirements may make any contract entered into with the City in connection with the Matter voidable by the City.

1. The Disclosing Party verifies that the Disclosing Party has searched any and all records of the Disclosing Party and any and all predecessor entities regarding records of investments or profits from slavery or slaveholder insurance policies during the slavery era (including insurance policies issued to slaveholders that provided coverage for damage to or injury or death of their slaves), and the Disclosing Party has found no such records.

2. The Disclosing Party verifies that, as a result of conducting the search in step 1 above, the Disclosing Party has found records of investments or profits from slavery or slaveholder insurance policies. The Disclosing Party verifies that the following constitutes full disclosure of all such records, including the names of any and all slaves or slaveholders described in those records:

\_\_\_\_\_  
\_\_\_\_\_  
\_\_\_\_\_

N/A

**SECTION VI -- CERTIFICATIONS FOR FEDERALLY FUNDED MATTERS**

**NOTE:** If the Matter is federally funded, complete this Section VI. If the Matter is not federally funded, proceed to Section VII. For purposes of this Section VI, tax credits allocated by the City and proceeds of debt obligations of the City are not federal funding.

**A. CERTIFICATION REGARDING LOBBYING**

1. List below the names of all persons or entities registered under the federal Lobbying Disclosure Act of 1995 who have made lobbying contacts on behalf of the Disclosing Party with respect to the Matter: (Add sheets if necessary):

\_\_\_\_\_  
\_\_\_\_\_  
\_\_\_\_\_

N/A

(If no explanation appears or begins on the lines above, or if the letters "NA" or if the word "None" appear, it will be conclusively presumed that the Disclosing Party means that NO persons or entities registered under the Lobbying Disclosure Act of 1995 have made lobbying contacts on behalf of the Disclosing Party with respect to the Matter.)

2. The Disclosing Party has not spent and will not expend any federally appropriated funds to pay any person or entity listed in Paragraph A.1. above for his or her lobbying activities or to pay any person or entity to influence or attempt to influence an officer or employee of any agency, as defined by applicable federal law, a member of Congress, an officer or employee of Congress, or an employee of a member of Congress, in connection with the award of any federally funded contract, making any federally funded grant or loan, entering into any cooperative agreement, or to extend, continue, renew, amend, or modify any federally funded contract, grant, loan, or cooperative agreement.

3. The Disclosing Party will submit an updated certification at the end of each calendar quarter in which there occurs any event that materially affects the accuracy of the statements and information set forth in paragraphs A.1. and A.2. above.

4. The Disclosing Party certifies that either: (i) it is not an organization described in section 501(c)(4) of the Internal Revenue Code of 1986; or (ii) it is an organization described in section 501(c)(4) of the Internal Revenue Code of 1986 but has not engaged and will not engage in "Lobbying Activities".

5. If the Disclosing Party is the Applicant, the Disclosing Party must obtain certifications equal in form and substance to paragraphs A.1. through A.4. above from all subcontractors before it awards any subcontract and the Disclosing Party must maintain all such subcontractors' certifications for the duration of the Matter and must make such certifications promptly available to the City upon request.

#### B. CERTIFICATION REGARDING EQUAL EMPLOYMENT OPPORTUNITY

If the Matter is federally funded, federal regulations require the Applicant and all proposed subcontractors to submit the following information with their bids or in writing at the outset of negotiations. N/A

Is the Disclosing Party the Applicant?

Yes

No

If "Yes," answer the three questions below:

1. Have you developed and do you have on file affirmative action programs pursuant to applicable federal regulations? (See 41 CFR Part 60-2.)

Yes

No

2. Have you filed with the Joint Reporting Committee, the Director of the Office of Federal Contract Compliance Programs, or the Equal Employment Opportunity Commission all reports due under the applicable filing requirements?

Yes

No

3. Have you participated in any previous contracts or subcontracts subject to the equal opportunity clause?

Yes

No

If you checked "No" to question 1. or 2. above, please provide an explanation:

N/A

## SECTION VII -- ACKNOWLEDGMENTS, CONTRACT INCORPORATION, COMPLIANCE, PENALTIES, DISCLOSURE

The Disclosing Party understands and agrees that:

A. The certifications, disclosures, and acknowledgments contained in this EDS will become part of any contract or other agreement between the Applicant and the City in connection with the Matter, whether procurement, City assistance, or other City action, and are material inducements to the City's execution of any contract or taking other action with respect to the Matter. The Disclosing Party understands that it must comply with all statutes, ordinances, and regulations on which this EDS is based.

B. The City's Governmental Ethics and Campaign Financing Ordinances, Chapters 2-156 and 2-164 of the Municipal Code, impose certain duties and obligations on persons or entities seeking City contracts, work, business, or transactions. The full text of these ordinances and a training program is available on line at [www.cityofchicago.org/Ethics](http://www.cityofchicago.org/Ethics), and may also be obtained from the City's Board of Ethics, 740 N.

Sedgwick St., Suite 500, Chicago, IL 60610, (312) 744-9660. The Disclosing Party must comply fully with the applicable ordinances.

C. If the City determines that any information provided in this EDS is false, incomplete or inaccurate, any contract or other agreement in connection with which it is submitted may be rescinded or be void or voidable, and the City may pursue any remedies under the contract or agreement (if not rescinded or void), at law, or in equity, including terminating the Disclosing Party's participation in the Matter and/or declining to allow the Disclosing Party to participate in other transactions with the City. Remedies at law for a false statement of material fact may include incarceration and an award to the City of treble damages.

D. It is the City's policy to make this document available to the public on its Internet site and/or upon request. Some or all of the information provided on this EDS and any attachments to this EDS may be made available to the public on the Internet, in response to a Freedom of Information Act request, or otherwise. By completing and signing this EDS, the Disclosing Party waives and releases any possible rights or claims which it may have against the City in connection with the public release of information contained in this EDS and also authorizes the City to verify the accuracy of any information submitted in this EDS.

E. The information provided in this EDS must be kept current. In the event of changes, the Disclosing Party must supplement this EDS up to the time the City takes action on the Matter. If the Matter is a contract being handled by the City's Department of Procurement Services, the Disclosing Party must update this EDS as the contract requires. **NOTE:** With respect to Matters subject to Article I of Chapter 1-23 of the Municipal Code (imposing **PERMANENT INELIGIBILITY** for certain specified offenses), the information provided herein regarding eligibility must be kept current for a longer period, as required by Chapter 1-23 and Section 2-154-020 of the Municipal Code.

The Disclosing Party represents and warrants that:



F.1. The Disclosing Party is not delinquent in the payment of any tax administered by the Illinois Department of Revenue, nor are the Disclosing Party or its Affiliated Entities delinquent in paying any fine, fee, tax or other charge owed to the City. This includes, but is not limited to, all water charges, sewer charges, license fees, parking tickets, property taxes or sales taxes.

F.2 If the Disclosing Party is the Applicant, the Disclosing Party and its Affiliated Entities will not use, nor permit their subcontractors to use, any facility listed by the U.S. E.P.A. on the federal Excluded Parties List System ("EPLS") maintained by the U. S. General Services Administration.

F.3 If the Disclosing Party is the Applicant, the Disclosing Party will obtain from any contractors/subcontractors hired or to be hired in connection with the Matter certifications equal in form and substance to those in F.1. and F.2. above and will not, without the prior written consent of the City, use any such contractor/subcontractor that does not provide such certifications or that the Disclosing Party has reason to believe has not provided or cannot provide truthful certifications.

NOTE: If the Disclosing Party cannot certify as to any of the items in F.1., F.2. or F.3. above, an explanatory statement must be attached to this EDS.

**CERTIFICATION**

Under penalty of perjury, the person signing below: (1) warrants that he/she is authorized to execute this EDS and Appendix A (if applicable) on behalf of the Disclosing Party, and (2) warrants that all certifications and statements contained in this EDS and Appendix A (if applicable) are true, accurate and complete as of the date furnished to the City.

DBDS HARLEM LLC  
(Print or type name of Disclosing Party)

By: [Signature]  
(Sign here)

ROBERTINO PROSSA  
(Print or type name of person signing)

MANAGER  
(Print or type title of person signing)

Signed and sworn to before me on (date) 9-8-2016,  
at DuPage County, IL (state).

[Signature] Notary Public.  
Commission expires: 8-13-2017.



**CITY OF CHICAGO  
ECONOMIC DISCLOSURE STATEMENT AND AFFIDAVIT  
APPENDIX A**

**FAMILIAL RELATIONSHIPS WITH ELECTED CITY OFFICIALS AND DEPARTMENT HEADS**

This Appendix is to be completed only by (a) the Applicant, and (b) any legal entity which has a direct ownership interest in the Applicant exceeding 7.5 percent. It is not to be completed by any legal entity which has only an indirect ownership interest in the Applicant.

Under Municipal Code Section 2-154-015, the Disclosing Party must disclose whether such Disclosing Party or any "Applicable Party" or any Spouse or Domestic Partner thereof currently has a "familial relationship" with any elected city official or department head. A "familial relationship" exists if, as of the date this EDS is signed, the Disclosing Party or any "Applicable Party" or any Spouse or Domestic Partner thereof is related to the mayor, any alderman, the city clerk, the city treasurer or any city department head as spouse or domestic partner or as any of the following, whether by blood or adoption: parent, child, brother or sister, aunt or uncle, niece or nephew, grandparent, grandchild, father-in-law, mother-in-law, son-in-law, daughter-in-law, stepfather or stepmother, stepson or stepdaughter, stepbrother or stepsister or half-brother or half-sister.

"Applicable Party" means (1) all executive officers of the Disclosing Party listed in Section II.B.1.a., if the Disclosing Party is a corporation; all partners of the Disclosing Party, if the Disclosing Party is a general partnership; all general partners and limited partners of the Disclosing Party, if the Disclosing Party is a limited partnership; all managers, managing members and members of the Disclosing Party, if the Disclosing Party is a limited liability company; (2) all principal officers of the Disclosing Party; and (3) any person having more than a 7.5 percent ownership interest in the Disclosing Party. "Principal officers" means the president, chief operating officer, executive director, chief financial officer, treasurer or secretary of a legal entity or any person exercising similar authority.

Does the Disclosing Party or any "Applicable Party" or any Spouse or Domestic Partner thereof currently have a "familial relationship" with an elected city official or department head?

Yes

No

If yes, please identify below (1) the name and title of such person, (2) the name of the legal entity to which such person is connected; (3) the name and title of the elected city official or department head to whom such person has a familial relationship, and (4) the precise nature of such familial relationship.

\_\_\_\_\_  
\_\_\_\_\_  
\_\_\_\_\_ *N/A*

**CITY OF CHICAGO  
ECONOMIC DISCLOSURE STATEMENT AND AFFIDAVIT  
APPENDIX B**

**BUILDING CODE SCOFFLAW/PROBLEM LANDLORD CERTIFICATION**

This Appendix is to be completed only by (a) the Applicant, and (b) any legal entity which has a direct ownership interest in the Applicant exceeding 7.5 percent (an "Owner"). It is not to be completed by any legal entity which has only an indirect ownership interest in the Applicant.

1. Pursuant to Municipal Code Section 2-154-010, is the Applicant or any Owner identified as a building code scofflaw or problem landlord pursuant to Section 2-92-416 of the Municipal Code?

Yes

No

2. If the Applicant is a legal entity publicly traded on any exchange, is any officer or director of the Applicant identified as a building code scofflaw or problem landlord pursuant to Section 2-92-416 of the Municipal Code?

Yes

No

Not Applicable

3. If yes to (1) or (2) above, please identify below the name of the person or legal entity identified as a building code scofflaw or problem landlord and the address of the building or buildings to which the pertinent code violations apply.

N/A

---

---

---

**FILLING OUT THIS APPENDIX B CONSTITUTES ACKNOWLEDGMENT AND AGREEMENT THAT THIS APPENDIX B IS INCORPORATED BY REFERENCE INTO, AND MADE A PART OF, THE ASSOCIATED EDS, AND THAT THE REPRESENTATIONS MADE IN THIS APPENDIX B ARE SUBJECT TO THE CERTIFICATION MADE UNDER PENALTY OF PERJURY ON PAGE 12 OF THE ASSOCIATED EDS.**