



City of Chicago



O2023-1211

Office of the City Clerk

Document Tracking Sheet

Meeting Date:	3/15/2023
Sponsor(s):	Misc. Transmittal
Type:	Ordinance
Title:	Historical landmark designation for Promontory Point east of S. Jean-Baptiste Pointe DuSable Lake Shore Dr. between 54th St. and 56th St.
Committee(s) Assignment:	Committee on Zoning, Landmarks and Building Standards



DEPARTMENT OF PLANNING AND DEVELOPMENT
CITY OF CHICAGO

March 10, 2023

The Honorable Anna M. Valencia
City Clerk
City of Chicago
Room 107, City Hall
121 North LaSalle Street
Chicago, IL 60602

**RE: Recommendation for designation of Promontory Point, located east of S. Jean-Baptiste
Pointe DuSable Lake Shore Drive Between 54th and 56th Streets, as a Chicago Landmark**

Dear Clerk Valencia:

We are filing with your office for introduction at the March 15, 2023, City Council meeting as a transmittal to the Mayor and City Council of Chicago the recommendation of the Commission on Chicago Landmarks that Promontory Point be designated as a Chicago Landmark.

The material being submitted to you for this proposal includes the:

1. Recommendation of the Commission on Chicago Landmarks; and
2. Proposed Ordinance.

Thank you for your cooperation in this matter.

Sincerely,

Kathleen E. Dickhut
Deputy Commissioner
Bureau of Citywide Systems & Historic Preservation

encls.

cc: Alderman Leslie A. Hairston, 5th Ward (*via email without enclosures*)

**CITY OF CHICAGO
COMMISSION ON CHICAGO LANDMARKS**

March 9, 2023

**RECOMMENDATION TO THE CITY COUNCIL OF CHICAGO THAT
CHICAGO LANDMARK DESIGNATION BE ADOPTED FOR**

PROMONTORY POINT

East of S. Jean-Baptiste Pointe DuSable Lake Shore Drive Between 54th and 56th Streets

Docket No. 2023-02

To the Mayor and Members of the City Council of the City of Chicago:

Pursuant to Section 2-120-690 of the Municipal Code of the City of Chicago (the "Municipal Code"), the Commission on Chicago Landmarks (the "Commission") has determined that Promontory Point, specifically that portion located east of S. Jean-Baptiste Pointe DuSable Lake Shore Drive between 54th and 56th Streets, Chicago, Illinois (the "Site"), is worthy of Chicago Landmark designation. On the basis of careful consideration of the history and architecture of the Site, the Commission has found that it satisfies the following four (4) criteria set forth in Section 2-120-620 of the Municipal Code:

1. *Its value as an example of the architectural, cultural, economic, historic, social, or other aspect of the heritage of the City of Chicago, State of Illinois, or the United States.*
4. *Its exemplification of an architectural type or style distinguished by innovation, rarity, uniqueness, or overall quality of design, detail, materials, or craftsmanship.*
5. *Its identification as the work of an architect, designer, engineer, or builder whose individual work is significant in the history or development of the City of Chicago, the State of Illinois, or the United States.*
7. *Its unique location or distinctive physical appearance or presence representing an established and familiar visual feature of a neighborhood, community, or the City of Chicago.*

I. BACKGROUND

The formal landmark designation process for the Site began on January 12, 2023, when the Commission approved a preliminary landmark recommendation (the "Preliminary Recommendation") for the Site as a Chicago Landmark. The Commission found that the Site meets four (4) of the seven (7) criteria for designation, as well as the integrity criterion, identified in the *Chicago Landmarks Ordinance* (Municipal Code, Section 2-120-580 *et seq.*). The Preliminary Recommendation, incorporated herein and attached hereto as **Exhibit 1**, initiated the

process for further study and analysis of the proposed designation of the Site as a Chicago Landmark.

As part of the Preliminary Recommendation, the Commission adopted a Designation Report, dated November 2022, the most current iteration of which is dated March 9, 2023, incorporated herein and attached hereto as **Exhibit 2** (the “Designation Report”).

On January 31, 2023, the Commission officially requested consent to the proposed landmark designation from the owner of the Site, the Chicago Park District. On February 22, 2023, the Commission received a form dated February 22, 2023, and signed by Rosa Escareno, the General Superintendent and CEO of the Chicago Park District, consenting to the proposed designation.

At its regular meeting of February 9, 2023, the Commission received a report from Maurice Cox, Commissioner of the Department of Planning and Development (DPD), supporting the proposed landmark designation of the Site. This report is incorporated herein and attached hereto as **Exhibit 3**.

II. FINDINGS OF THE COMMISSION ON CHICAGO LANDMARKS

WHEREAS, pursuant to Section 2-120-690 of the Municipal Code, the Commission has reviewed the entire record of proceedings on the proposed Chicago Landmark designation, including the Designation Report, the DPD Report, and all of the information on the proposed landmark designation of the Site; and

WHEREAS, the Site meets the four (4) criteria for landmark designation set forth in Section 2-120-620 (1), (4), (5), and (7) of the Municipal Code; and

WHEREAS, the Site was first envisioned as part of Daniel Burnham’s seminal 1909 *Plan of Chicago* which proposed the use of artificial fill to construct a magnificent stretch of new parkland between Grant and Jackson Parks; and

WHEREAS, in 1934, Chicago voters approved the Park Consolidation Act, thereby establishing the Chicago Park District and, with it, the means to access money through the Works Progress Administration (WPA), President Roosevelt’s New Deal program to provide work to millions of jobseekers through the completion of public works programs. The Chicago Park District secured WPA funds from 1935 through 1939 to complete the Site, employing thousands of Chicagoans during the Great Depression while creating a new peninsular park which provided South Siders with a beautiful haven just steps from Jean-Baptiste Pointe DuSable Lake Shore Drive with spectacular views and access to the lake; and

WHEREAS, in 1953, during the Cold War, the United States military installed a Nike missile launcher area in Jackson Park and a radar area at the Site. Although some community organizations resented the installation of radar towers and were supported by Hyde Park Alderman Leon Despres and Congressman Barratt O’Hara, it was not until the anti-Vietnam War movement grew that community members became more ardent in their demands for removal of the structures. In 1970, U.S. Congressman Abner Mikva led 500 demonstrators who protested the Vietnam War

and demanded the removal of the Nike missile bases. The federal government finally closed the Site's Nike installation in 1971; and

WHEREAS, Alfred Caldwell, landscape designer of the Site, was mentored by Jens Jensen and is considered to be one of the great landscape architects of the Prairie style. This naturalistic approach to landscape design developed in the late nineteenth and early twentieth centuries and used native vegetation and other features of the Midwest to emphasize the region's open character and horizontal expanses; and

WHEREAS, the Site's Pavilion Building is a fine French Eclectic-style building designed by Emanuel Valentine Buchsbaum, a notable Chicago architect. Buchsbaum's career began under architect R. Harold Zook with projects including the Maine East High School and the Pickwick Theatre in Park Ridge, Illinois. During the 1930s to 1970s while head architect and later an engineer for the Chicago Park District, Buchsbaum built structures throughout Chicago's park system, some of the most noteworthy being the 1931 Grant Park Band Shell (demolished 1978), the 1938 Art Moderne "lake steamer" North Avenue Beach House (demolished 1999) and 1937 Montrose Avenue Beach House (west wing extant), and the 1956 Henry Horner Park Field House; and

WHEREAS, Frederick C. and Elisabeth Haseltine Hibbard, sculptors of the *David Wallach Fountain*, installed and dedicated at the Site in 1939, were important Chicago artists whose sculptural work was exhibited and installed throughout the United States; and

WHEREAS, the Site is a significant example of Alfred Caldwell's Prairie style of landscape architecture; and

WHEREAS, the Site retains the city's last largely intact stretch of limestone step-stone revetments, variations of which once defined most of Chicago's shoreline during the twentieth century; and

WHEREAS, with its distinctive curved landform that juts out into Lake Michigan and its stepped limestone revetments that provide park visitors close access to the water, Promontory Point is an iconic visual feature along Chicago's lakefront; now, therefore,

THE COMMISSION ON CHICAGO LANDMARKS HEREBY:

1. Adopts the recitals, findings, and statements of fact set forth in the preamble and Sections I and II hereof as the findings of the Commission; and
2. Adopts the Final Designation Report, as revised, and dated this 9th day of March 2023, and
3. Finds, based on the Designation Report and the entire record before the Commission, that the Site meets the four (4) criteria for landmark designation set forth in Sections 2-120-620 (1), (4), (5), and (7) of the Municipal Code; and

4. Finds that the Site satisfies the "integrity" requirement set forth in Section 2-120-630 of the Municipal Code; and
5. Finds that the significant historical and architectural features of the Site are identified as follows:
 - All exterior elevations and roofline of the Pavilion Building; and
 - The pathways, council rings, *David Wallach Fountain*, and limestone revetments; and
 - Alfred Caldwell's landscape design of a central meadow edged by irregular groupings of plants and trees.

Routine landscape maintenance is excluded from review. Species selection of individual plants and trees is also excluded from review in recognition of the potential need for change to the plant palette to ensure that the park landscape is resilient in the face of climate change.

6. Recommends that the Site be designated a Chicago Landmark.

This recommendation was adopted unanimously (8-0)

Ernest C. Wong, Chairman
Commission on Chicago Landmarks

Dated: March 9, 2023

Exhibit 1

Resolution
by the
Commission on Chicago Landmarks
on the
Preliminary Landmark Recommendation
for

PROMONTORY POINT

East of S. Jean Baptiste Point du Sable Lake Shore Drive, Between 54th and 56th Streets

January 12, 2023

Whereas, the Commission on Chicago Landmarks (the "Commission") preliminarily finds that:

- That portion of Promontory Point, as delineated in Exhibit A, attached hereto, (the "Site"), meets the four (4) criteria for landmark designation set forth in Section 2-120-620 (1), (4), (5), and (7) of the Municipal Code of Chicago (the "Municipal Code"), as specifically described in the Preliminary Summary of Information (the "Preliminary Summary") submitted to the Commission on this 12th day of January, 2023, by the Department of Planning and Development; and
- the Site satisfies the historic integrity requirement set forth in Section 2-120-630 of the Municipal Code as described in the Preliminary Summary; now, therefore,

Be it resolved by the Commission on Chicago Landmarks:

Section 1. The above recitals are expressly incorporated in and made part of this resolution as though fully set forth herein.

Section 2. The Commission hereby adopts the Preliminary Summary and makes a preliminary landmark recommendation concerning the Site in accordance with Section 2-120-630 of the Municipal Code.

Section 3. For purposes of Section 2-120-740 of the Municipal Code governing permit review, the significant historical and architectural features of the Site are preliminarily identified as:

- All exterior elevations and roofline of the Pavilion Building, and
- The pathways, council rings, *David Wallach Fountain*, and limestone revetments.

Plantings and trees are specifically excluded from the significant features.

Section 4. The Commission hereby requests a report or statement from the Commissioner of the Department of Planning and Development which evaluates the relationship of the proposed designation to the City's governing plans and policies and the effect of the proposed designation on the surrounding neighborhood in accordance with Section 2-120-640 of the Municipal Code.

This recommendation was adopted unanimously (8-0).

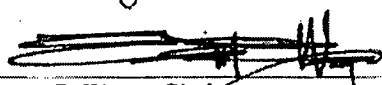
Ernest C. Wong, Chairman
Commission on Chicago Landmarks

Dated: January 12, 2023

Exhibit 2



DEPARTMENT OF PLANNING AND DEVELOPMENT CITY OF CHICAGO

February 9, 2022

Report to the Commission on Chicago Landmarks
On the Landmark Designation of
Promontory Point
East of S. Jean-Baptiste Pointe DuSable Lake Shore Drive Between 54th and 56th Streets

The Department of Planning and Development (DPD) finds that the proposed landmark designation of Promontory Point supports the City's overall planning goals for the surrounding Hyde Park Community Area and is consistent with the City's governing policies and plans.

Promontory Point is a lakefront peninsula located in the Hyde Park Community Area at the south end of the 600-acre, lakeside Burnham Park. The site was constructed from artificial landfill edged by stepped limestone revetment and was completed in the late 1930s with money from the federal Works Progress Administration. Alfred Caldwell, a talented Prairie School landscape architect, produced a plan for Promontory Point that made dramatic use of the site's prized peninsular views and architect Emanuel V. Buchsbaum, the CPD's head architect, designed a French Eclectic-style pavilion with a central tower. Frederick C. and Elizabeth Haseltine Hibbard designed a sculptural fountain, the *David Wallach Fountain*, installed near the Lakefront Trail just east of the 55th Street underpass, which was dedicated in 1939.

Promontory Point is zoned POS-1 (Parks and Open Space). Burnham Park lies to the north and Jackson Park to the south. Additional parkland sits west of Jean-Baptiste Pointe DuSable Lake Shore Drive. West and north of this, land use is primarily residential with dense, multi-unit buildings including high-rises. To the south, the Museum of Science and Industry is located inside Jackson Park.

A Metra Station Typology Study, approved by the Chicago Plan Commission in 2014, identified the 55th-56th-57th Street Metra Station, five blocks to the west of Promontory Point, as a "Major Activity Center," located outside downtown with a balanced mix of residential, commercial, and employment-generating uses, with residential development typically provided in mid- to high-rise buildings. The pedestrian environment surrounding the station was noted as an important aspect of the area. Promontory Point's pedestrian accessibility, as established with the 55th Street Underpass, aligns with this character.

More recently, DPD has embarked on "We Will Chicago," a citywide planning initiative which is now in draft form. One goal of the plan is to maintain and expand green space, natural resources, and conservation efforts for the benefit of all Chicagoans. Promontory Point is part of Burnham Park, created as public parkland for the benefit of all Chicagoans, and has been embraced and continually put to use by citizens from its inception. Landmark designation would further signify the City's commitment to maintaining this green space for all.

DPD has also provided input to the Chicago Park District's 2018 update to the South Lakefront Framework Plan which looks just south of Promontory Point to Jackson Park and the South Shore Cultural Center. This plan sought community input for a vision which balanced a broad diversity of park users from recreation to refuge seekers and from regulars to those just visiting.

The landmark designation of Promontory Point aligns with several of the guiding principles underlying the plan:

- Integrate buildings and landscapes to shape beautiful parks that provide an enhanced quality of life for their users;
- Underscore the many natural assets of the lakefront park landscape;
- Celebrate and reconnect with the water;
- Reinvigorate the parks as a global attraction with cultural destinations and historically significant landscapes;
- Draw on historic use, character, and design philosophy to inform the future; and
- Continue to promote spaces that connect the community with nature.

Though Promontory Point was not included in the geography of the South Lakefront Framework Plan, the plan's recommendations regarding culture and history also mesh with the proposed designation of Promontory Point:

- The framework plan builds on the legacy of serving contemporary park users while respecting a fabric of historically significant cultural, recreational, and natural landscapes. Historic buildings...contribute to the cultural value of the parks and attract visitors from near and far.

The plan update was part of an extensive review process undertaken by the City of Chicago for conversion of a 19-acre site in Jackson Park for use as the Obama Presidential Center museum campus. DPD is one of the agencies monitoring the memorandum of agreement which resulted from that effort which lays out the improvements to be undertaken by the Chicago Park District, the Obama Foundation, and the Chicago Department of Transportation. Currently, improvements to Jackson Park have included roadway realignment, site work for the Obama Presidential Center, work on a historic interpretation plan for Jackson Park, and conceptual plans for Midway Plaisance improvements. When these and other projects have been

completed, they will support a revitalized Jackson Park and strengthen the surrounding area including Promontory Point.

Therefore, DPD finds that the proposed landmark designation of Promontory Point supports the City's overall planning goals for the surrounding Hyde Park Community Area and is consistent with the City's governing policies and plans.



Maurice Cox, Commissioner
Department of Planning and Development

LANDMARK DESIGNATION REPORT



PROMONTORY POINT

**EAST OF S. JEAN-BAPTISTE POINTE DUSABLE LAKE SHORE DRIVE,
BETWEEN 54TH AND 56TH STREETS**

**Final Landmark Recommendation adopted by the Commission on Chicago
Landmarks, March 9, 2023**



CITY OF CHICAGO
Lori E. Lightfoot, Mayor

Department of Planning and Development
Maurice D. Cox, Commissioner

Cover photo by Eric Allix Rogers.

CONTENTS

Introduction	1
Development of Chicago's South Lakefront	4
Completion of Promontory Point	6
Promontory Point Description and Style	10
The Site	10
The Pavilion	15
<i>The David Wallach Fountain</i>	17
Landscape Architect Alfred Caldwell	17
Architect Emanuel V. Buchsbaum	20
Sculptors Frederick C. and Elizabeth Haseltine Hibbard	22
Promontory Point's Later History	24
Alterations and Restoration	24
Criteria for Designation	27
Significant Architectural and Historical Features	29
Selected Bibliography	30

PROMONTORY POINT

BUILT: 1922-1939

PARTIAL RESTORATION: 1989

ERA OF SIGNIFICANCE: 1922-1989

ARCHITECT: EMANUEL V. BUCHSBAUM

LANDSCAPE ARCHITECT: ALFRED CALDWELL

SCULPTORS: FREDERICK C. AND ELIZABETH HASELTINE HIBBARD

Introduction

A forty-acre greenspace located at the south end of Chicago's 600-acre Burnham Park, Promontory Point is a lakefront peninsula made entirely of artificial lakefill. Jutting out into Lake Michigan, the site's curving landform, edged by stepped limestone revetments, provides views and physical access to the water and was originally known as the 55th Street Promontory. Renowned architect and planner Daniel H. Burnham conceived of using imported fill to construct linear parkland extending into Lake Michigan along the southern half of the City's lakeshore as part of an ambitious lakefront expansion scheme incorporated into his seminal 1909 *Plan of Chicago*. Development of the new greenspace began in the 1910s, but proceeded slowly due to the need for complex negotiations with private owners, approvals from government entities, and funding. In the mid-1930s, the federal government provided relief funds which allowed the newly consolidated Chicago Park District (CPD) to complete Promontory Point.

Alfred Caldwell, a talented Prairie School landscape architect, produced a plan for Promontory Point that made dramatic use of the site's prized peninsular views, featured a broad central meadow edged with trees and other naturalistic plantings, and included circular layered-stone benches known as council rings which symbolized the council fires of North America's native peoples. Architect Emanuel V. Buchsbaum, the CPD's head architect, designed a French Eclectic-style pavilion with a central tower to perch atop the highest point of the site near Lake Michigan. In the late 1930s, when Promontory Point was nearly complete, Frederick C. and Elizabeth Haseltine Hibbard designed a sculptural fountain to provide drinking water for "man and beast" in the spirit of the donor's wishes. Named after the benefactor, the *David Wallach Fountain* was installed near the Lakefront Trail just east of the 55th Street underpass.

This report owes much to the "Promontory Point, Burnham Park" document written by Julia S. Bachrach as a consultant for the Promontory Point Conservancy. We thank Ms. Bachrach and the Promontory Point Conservancy for providing this text and allowing us to excerpt and edit much of it as the basis of this designation report.

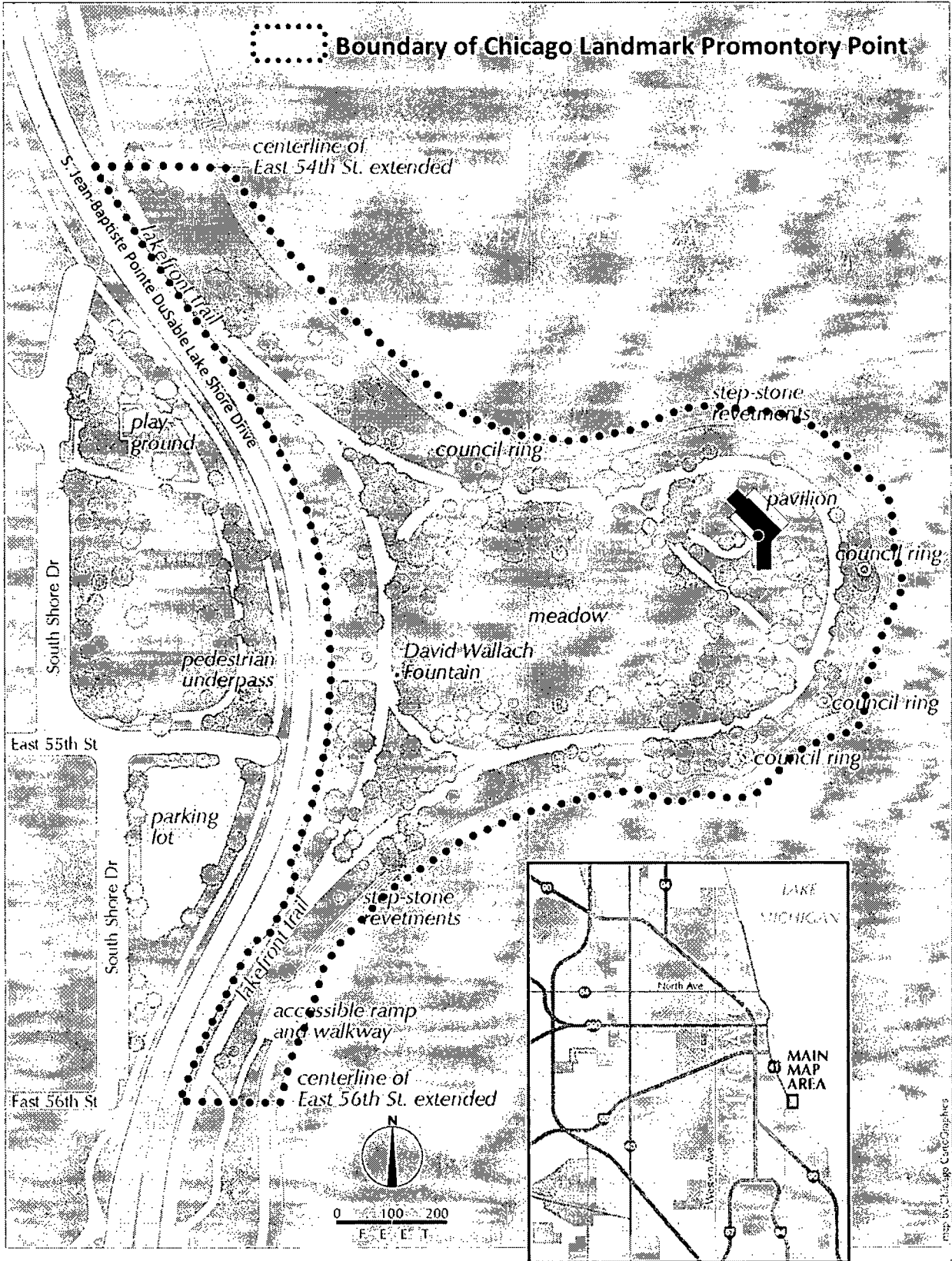

Above: Promontory Point.
 (Base map by Dennis McClendon, Chicago CartoGraphics)

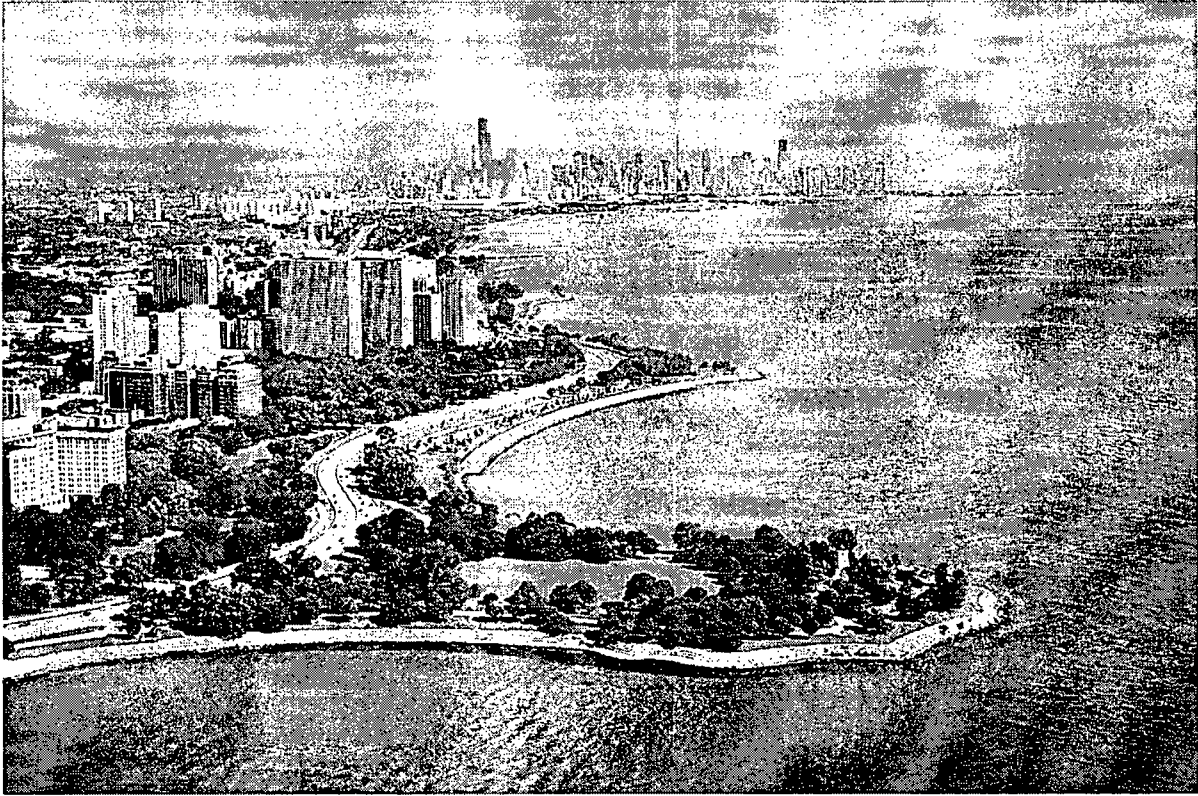

Above: View looking north toward Promontory Point and the city center beyond. (Source: ChooseChicago.com) **Below: Looking south at the east end of Promontory Point, 2017.** (Photo by Antonio Perez; Source: *Chicago Tribune*)

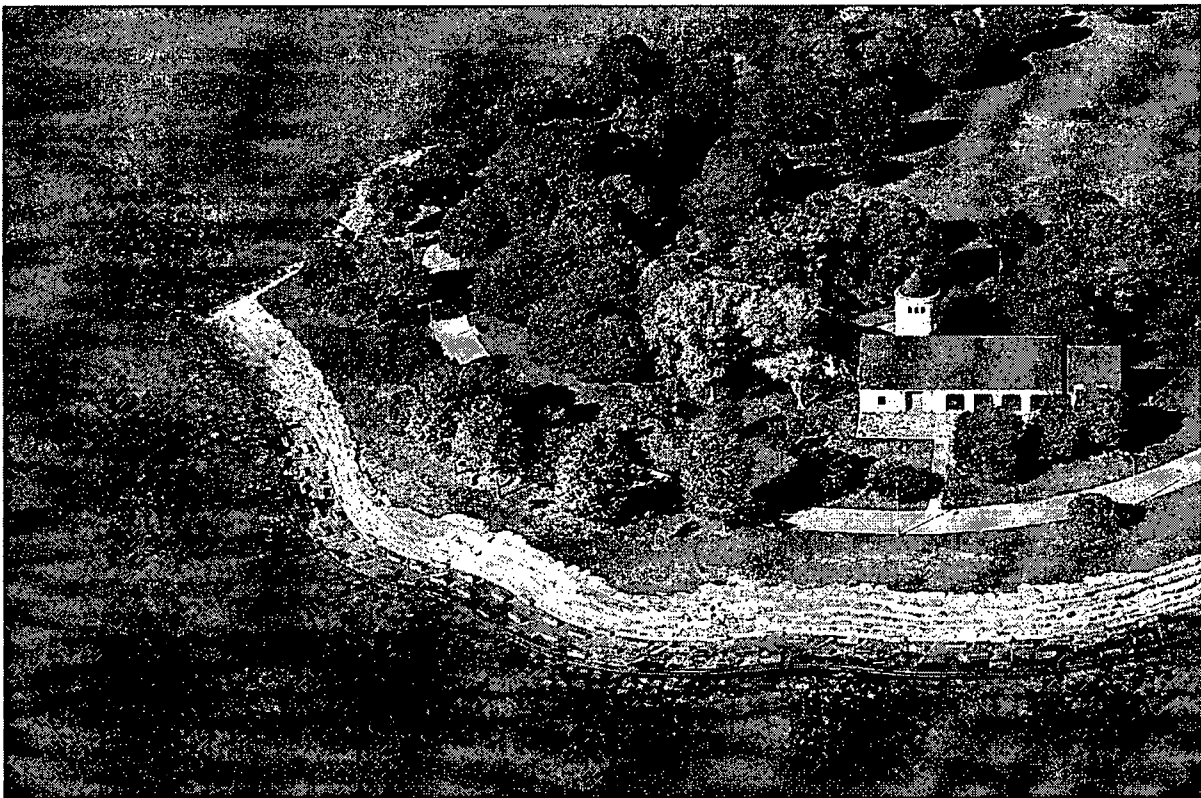

Development of Chicago's South Lakefront

Chicago's celebrated architect and planner Daniel Hudson Burnham began making sketches for what would eventually become Burnham Park shortly after the 1893 World's Columbian Exposition. Having served as Director of Works for the exposition (which took place in Jackson Park, located between 56th and 66th Streets along the lake), Burnham proposed preserving part of the old fairgrounds and linking it with downtown via a new linear lakefront park and pleasure drive. By the mid-1890s, his drawings included a ribbon-like greenspace with islands, a promontory, a harbor and lagoon, boat houses, bicycle paths, and a scenic roadway. A *Chicago Tribune* article entitled "The Lake-Front Scheme," published on October 12, 1896, described Burnham's proposal as "one of the grandest schemes ever contemplated in municipal improvement."

The South Park Commission (SPC), the agency responsible for the parks in that area of the city, fully supported Burnham's idea, but did not possess riparian rights to the lakefront site. Some years earlier, the City of Chicago had transferred those rights to the Illinois Central Railroad Company (ICRR). To create new parkland along the lakefront, the SPC needed to negotiate for these rights and resolve other complex legal issues including obtaining approvals from every level of government. Since Lake Michigan is a navigable body of water, permission would also be needed from the United States Secretary of War.

As the SPC confronted these issues, Burnham refined his designs. By the early 1900s, he had hired a talented, young architect, Edward H. Bennett, who soon co-authored the 1909 *Plan of Chicago* with him. The *Plan* included detailed illustrations of a proposed stretch of new parkland between the centrally located Grant Park (the "front yard" of Chicago located between Lake Michigan and the central business district) and Jackson Park (the South Side's major lakeside park). The linear park would have a scenic pleasure drive as well as a long inner lagoon and several offshore islands. The plan also called for a wide promontory that would jut out into Lake Michigan near the park's southern boundary.

Just weeks after Daniel H. Burnham died in 1912, the State of Illinois adopted an act granting the SPC the right to acquire land and undertake condemnation procedures to create the new park. The park commissioners then began efforts to gain all other necessary approvals for the project, a complex process that took several years. In 1919, Chicago's City Council and subsequently the SPC and the ICRR approved the Lake Front-Illinois Central Ordinance. In early 1920, once the Secretary of War had signed a permit allowing the commissioners to proceed, the public signified its support by voting in favor of an initial twenty-million-dollar bond issue to fund the first phase of park construction and allow landfill operations to begin.

A guidebook published by the Illinois State Geological Survey describes the process of "lakefilling" to create new parkland. The first step involved establishing a new outer shoreline beyond the existing one through the construction of bulkheads and then filling in the area behind it with material dredged from the lake and other debris. New shoreline structures generally required wooden piles and sheeting, steel tie rods, rock fill, and cut limestone, but some stretches of shoreline were established as paved or perched sand beaches. From 1910 to 1931, bulkheads were constructed from the north to the south side of the city.

To establish the bulkheads, workers had to drive parallel rows of enormous timber pilings into the lakebed. Wood "Wakefield" sheeting was installed up against the piles and the two rows of vertical piles were then bound together with steel bands. These were filled with loose stone to

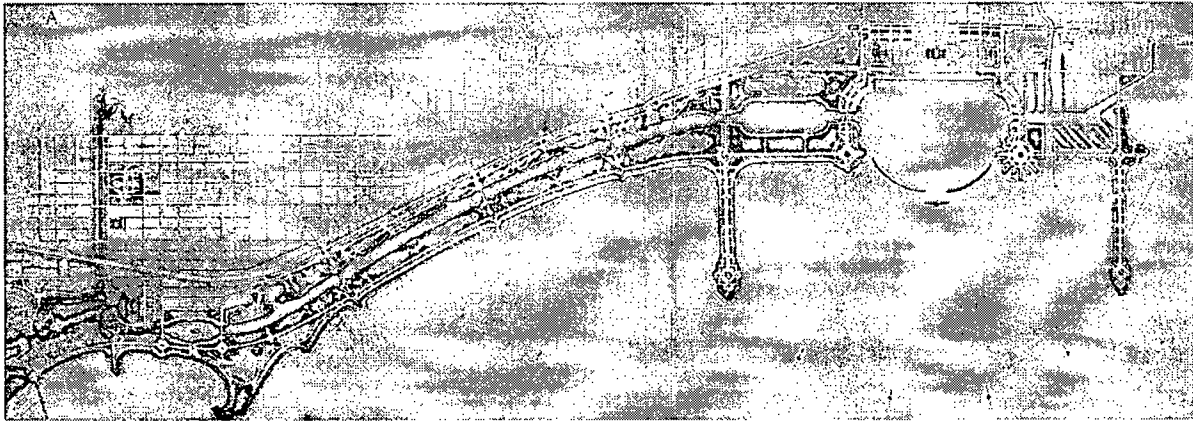

Above: This illustration from the 1909 *Plan of Chicago* shows the proposed lakefront extension. (Chicago Avenue is at right/north and Jackson Park is at left/south.) The architects asserted that the ambitious new park could “be built by utilizing the wastage from the city and excavated material at practically no cost.” The area that would become known as Promontory Point is at the far left side of the plan.

Right: Illustration of the typical bulkhead and revetment design used for the construction of Burnham Park.

(Drawing by Michael J. Chrzastowski from CPD 1944 in “Make No Little Plans: Field Trip Guidebook for the American Shore & Beach Preservation Association 2008 National Conference.”)

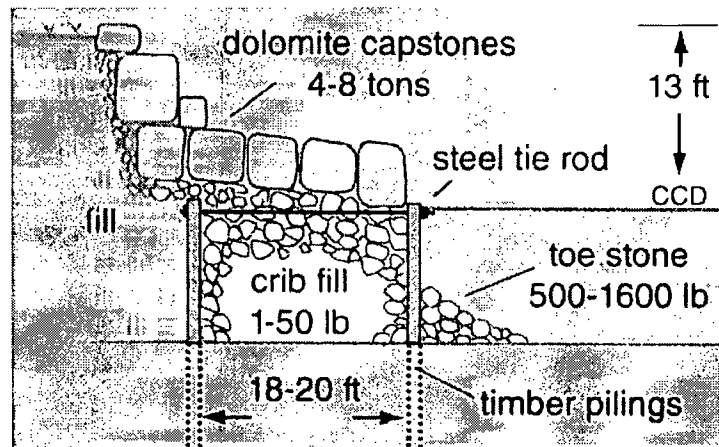

Right: Looking south, circa 1930, bulkheads outline Promontory Point but infill is not complete.

Source: Chicago Historical Society ICHI-26816)

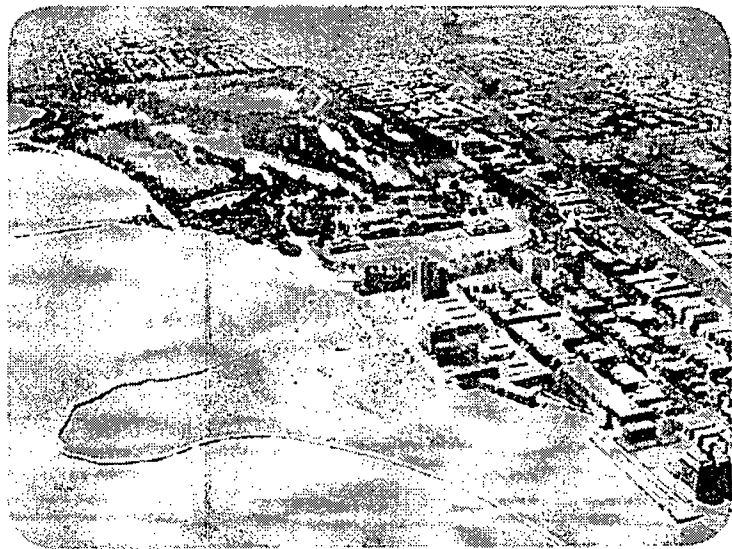

create strong “cribs” which could hold in the fill loaded behind them. Fill was then added between the cribs and the original shoreline. Clay fill was dredged from the lake while sand fill was pumped in from the bottom of the lake or brought in from dunes in Indiana or Michigan. The fill included clean construction debris and other dumped materials.

Revetments (retaining walls of impact-resistant materials) were needed to protect the new parkland from wave action and erosion. Along most of Burnham Park (including what would become Promontory Point) and portions of the north side, multi-ton blocks of limestone were stacked atop the cribs to create a platform which extended to fill at roughly the same grade. Blocks were then stacked in tiers up the side of the land mass until the desired grade was reached.

In the fall of 1920, landfill operations were initiated at Burnham Park’s north end between 11th Place and 23rd Street. (This area became known as Northerly Island.) By early 1922, contractors began working on another area at the new park’s south end, soon completing 6,315 linear feet of bulkhead between 50th and 57th Streets. Continuing progress was slow and uneven, however. In 1926, the *Hyde Park Herald* published “An Historical Sketch of a Rubbish Pile: After Fourteen Years Ashmen Are Making the Fill Very Leisurely.” This article noted that, though the north end of the park had been completed years earlier, little progress had been made in filling the area between 53rd and 55th Streets. The reporter suggested that, in this southern part of the proposed park, one could watch as “all sorts of rubbish—ashes, tin cans, broken brick, plastering from walls of demolished buildings, dirt from excavations, etc.” was slowly hauled in by carts and wheelbarrows and dumped into the pit-like fill site. Despite its unfinished condition, in 1927, the SPC Board of Commissioners officially named the new lakeside park planned to extend the five or so miles between Roosevelt Road (south of downtown) and 57th Street (on the South Side) in honor of Daniel H. Burnham.

Completion of Promontory Point

By the 1930s, there were twenty-two independent park districts operating contemporaneously in Chicago. Although civic leaders had spent years discussing the need to consolidate the numerous park districts into a single organization, many of the existing districts had been reluctant to give up their autonomy. Things changed when the Great Depression rendered most, if not all, of these government agencies financially insolvent. In 1934, voters approved the Park Consolidation Act, thereby establishing the Chicago Park District and, with it, the means to access money through the Works Progress Administration (WPA), President Roosevelt’s New Deal program to provide work to millions of jobseekers through the completion of public works programs.

Chicago’s Mayor Edward J. Kelly, who had previously served as Chief Engineer of the Chicago Sanitary District and as President of the South Park Commission’s Board, took a keen interest in organizing the new CPD. For the position of General Superintendent, he selected his brother-in-law, George T. Donoghue, a professional engineer who had served as the Superintendent to the South Park District since 1926. Donoghue soon hired a very large and highly qualified staff, particularly for the CPD’s engineering and landscape divisions.

The engineering division provided a broad scope of services ranging from architectural design and traffic engineering to repairs and construction. Ralph H. Burke, a former Sanitary District engineer who had become a prominent WPA administrator in Illinois, was appointed to head the

CPD's engineering department. Burke helped secure millions of dollars of funding for CPD projects.

By 1932, S. Jean-Baptiste Pointe DuSable Lake Shore Drive (then Leif Ericson Drive) reached 57th Street. To facilitate traffic speed and maintain safer roadways, CPD Chief Engineer Ralph Burke's plans for continued development of Burnham Park maintained the " 'elevated-highway-like' characteristics of the south side outer drive" according to a 1935 *Chicago Tribune* article titled "Superhighway to Rule in Burnham Park." The WPA-funded project included grade separations to provide pedestrian access to Burnham Park's east side, with a new underpass just north of 55th Street. In addition to this work, half a million dollars in WPA funds had been secured to begin development of the 55th Street Promontory (now known as Promontory Point). The funding allowed for site preparation including filling and grading, and initial construction of the pavilion and lakeshore revetments.

By 1936, CPD architect Emanuel Buchsbaum and his staff architects had produced plans for the pavilion building. At that time, landscape architect Alfred Caldwell had joined the staff of the CPD. He worked with the park's already established design to create a landscape in his signature Prairie style which took best advantage of the peninsula's site.

The CPD had already determined the site's general layout and a 1936 photograph of the site shows work underway. Derricks are poised over the water at most of the perimeter as the revetments take shape. The existing "Outer Drive" and underpass at the west end of the site somewhat dictated the topography, and excavation had been undertaken to accommodate entry to the promontory via the underpass. At the eastern end of the site, the foundation of the pavilion, which would function as a public shelter with bathrooms, was beginning to take shape. By fall of that year, a curving circuit path had been laid around the perimeter and grading work was significantly completed with land sloping gently down from the east toward the west end of the site.

A February 14, 1937, article in the *Chicago Tribune* reported that newly secured WPA funds in the amount of a quarter million dollars would assure completion of the park and noted the current status:

The shelter houses and comfort stations were partly completed with funds from the original grant. All but 6,000 of the 20,000 tons of rip-rap stone to be used in the protecting wall around the promontory were in place. Completely installed are the water, electricity, and drainage facilities, and the concrete bases for the pavements and sidewalks.

In addition to completion of work already under way, the new allocation will provide for construction of a stone terrace 18 feet back of the sea wall piling to hold the earth bank in place. About 16,000 tons of stone will be used at a cost of \$3 per ton. All of the landscaping, including planting of 2,000 trees and 5,800 shrubs, remains to be done.

A photo of the site from later in 1937 shows the tower of the pavilion under construction above completed wings. The terrain has been smoothed out over the central meadow and almost all the derricks are gone, suggesting the revetments were on their way to being completed. Trees have begun to be planted.

Additional WPA funding secured in 1938 went toward completion of the pavilion, revetments, and landscaping. Additional plantings continued and boulders were installed per Caldwell's

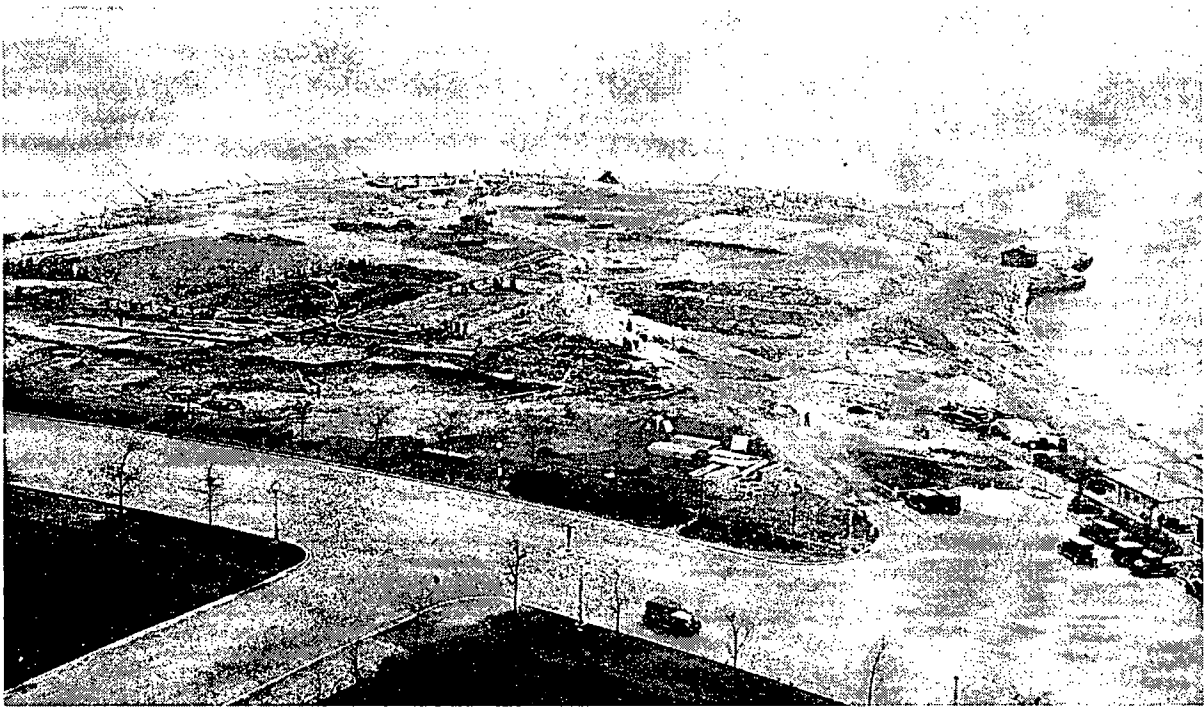

Above: Looking northeast toward Promontory Point, 1936. Work is underway to complete re-retirements and grading. (Source: Chicago Park District Records: Photographs, Chicago Public Library Special Collections)

Below: Promontory Point, 1937. The underpass at 55th Street has been completed. The wings of the pavilion have been constructed and the tower is underway. (Source: Chicago Park District Records: Photographs, Chicago Public Library Special Collections)

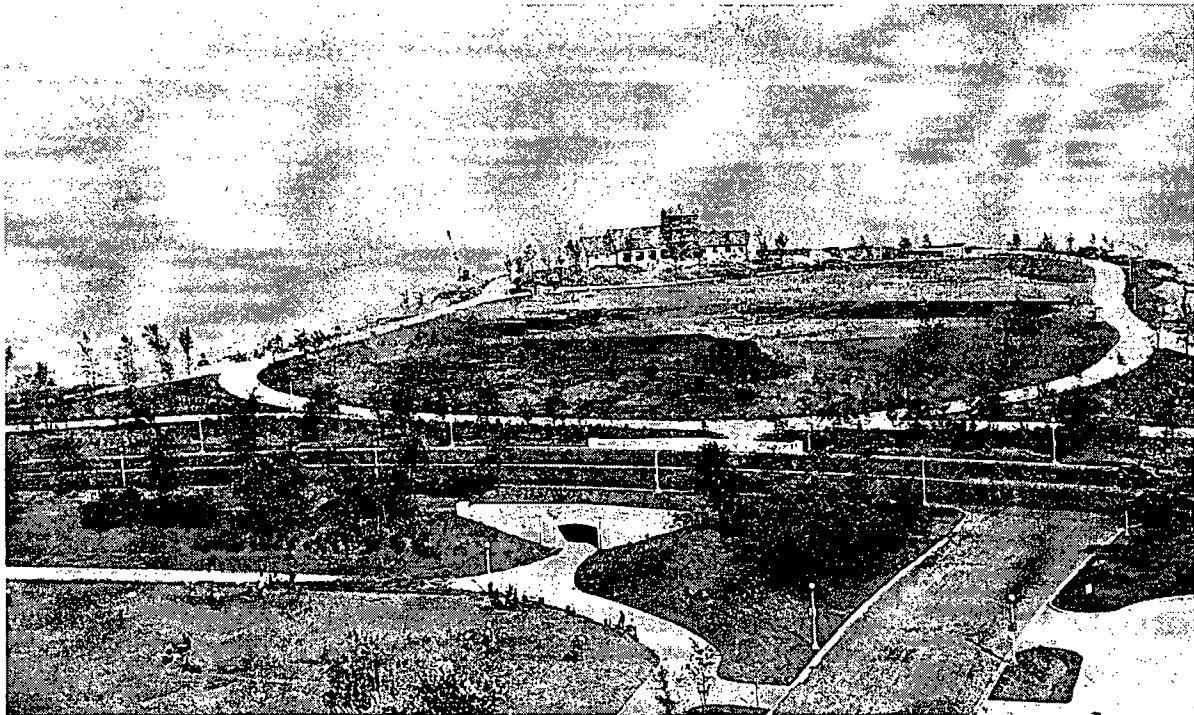

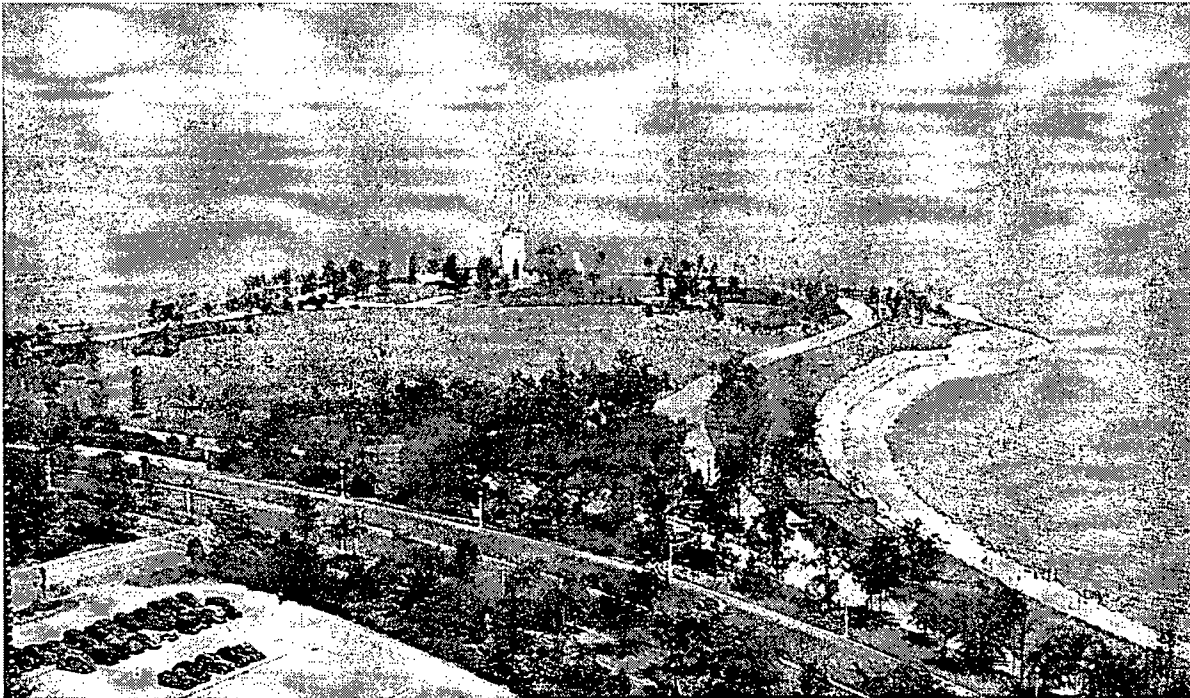

Above: Promontory Point, circa 1940. (Source: Chicago Park District Records: Photographs, Chicago Public Library Special Collections)

Below: Promontory Point, circa 1945. (Source: Chicago Park District Records: Photographs, Chicago Public Library Special Collections)

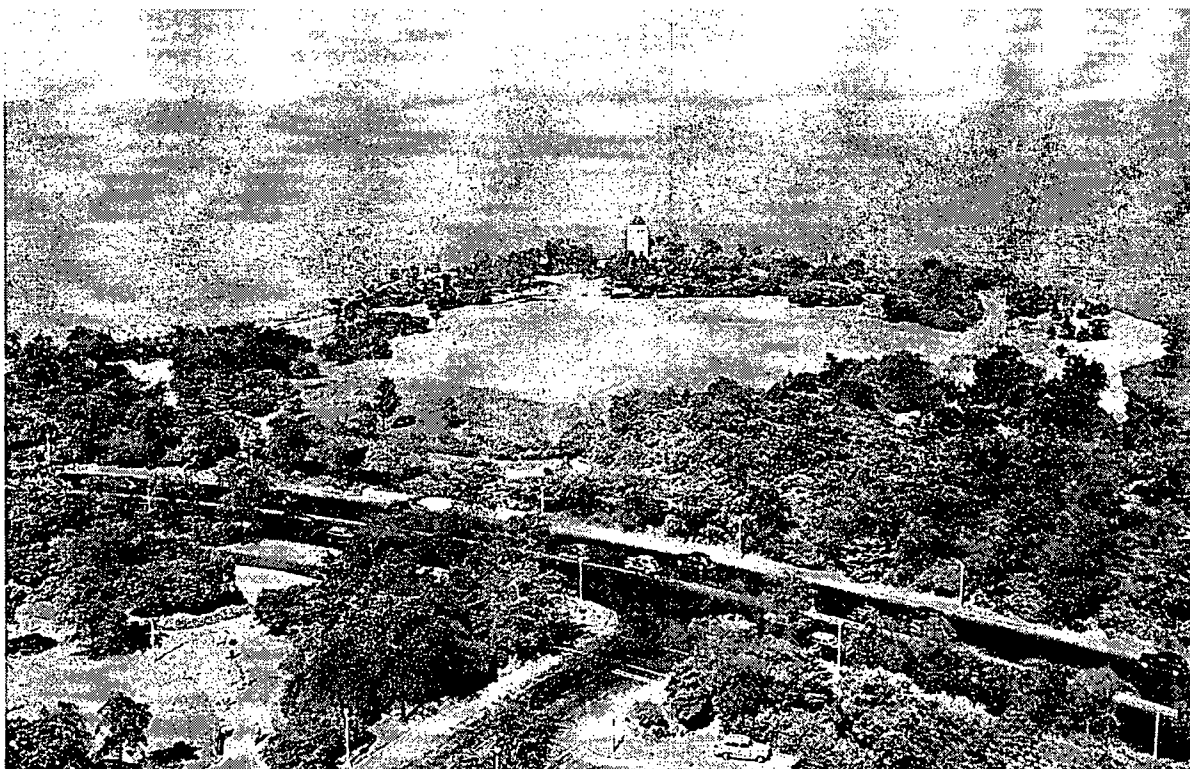

plans though hexagonal concrete benches would be substituted for the circular stone council rings he had proposed. Caldwell was also asked to revise his plans to include a fountain designed by Frederick C. and Elizabeth Haseltine Hibbard. The marble fountain with bronze resting fawn sculpture was installed to align with the western underpass entry to the park. It was dedicated in 1939, marking the completion of the 55th Street Promontory.

Promontory Point Description and Style

The Site

Promontory Point (known originally as the 55th Street Promontory) is located at the south end of Burnham Park between East 54th and East 56th Streets, and extends into Lake Michigan. The landform has an irregular rounded shape, slightly concave at the north and south sides. Along most of its perimeter, step-stone ledges terraced down to a platform at the edge of the water.

Historically, all of the step-stone tiers would have been composed of large limestone blocks. Over the years, wave action has caused the stones to shift and swept a small percentage into the lake. The resulting uneven surfaces and missing portions prompted repairs. The most visible of these replaced the stone platform from north of the pavilion around the east side of the peninsula with concrete. Almost ninety evenly spaced 2' x 8' x 2' concrete deflectors are located on this concrete platform. The platform and deflectors were part of a shoreline repair project designed and specified by CPD in-house engineers in 1964 and constructed by the J.M. Corbett Company the following year. During this project, the adjacent tiers of step-stone revetments were retained and reset.

In other work, revetment at the north end of Promontory Point parallel with the roadway has been covered with riprap stone in two places while the platform of the section in between has been covered in concrete. Wave action has been sufficient along the northern half of this section to dislodge even the upper tiers of stone. With the exception of these areas and a small stretch at the southern end where ADA improvements replaced the tiers and platform with an accessible ramp, step-stone revetments remain in place along the perimeter of Promontory Point. Damage at the platform's edge appears more severe on the north side of the Point than along the south.

Although a parking lot south of 55th Street and greenspace north of it were improved as part of the Promontory, Leif Ericson Drive (now S. Jean-Baptiste Pointe DuSable Lake Shore Drive) had already been built and created a natural division of the Promontory. The much larger eastern portion constitutes the peninsular form which sets this site apart from any other portion of Burnham Park. South Jean-Baptiste Pointe DuSable Lake Shore Drive bounds the western edge of the primary site in a shallow curved configuration. Automobiles are not permitted inside Promontory Point. Pedestrian access from the west is provided by an underpass that extends beneath the roadway. This path connects directly to Promontory Point's portion of the eighteen-mile Chicago Lakefront Trail. The Lakefront Trail serves as the western edge of Promontory Point's circuit path. The *David Wallach Fountain* is located just east of the Lakefront Trail, on axis with the underpass.

The circuit path surrounds the site's central meadow—a broad lawn that is edged with trees and shrubs—and loops around the eastern end of the Point. Towards that end, a slightly narrower path bisects the meadow and links the north and south sides of the circuit path. A short curving pathway leads from the bisecting path east to the pavilion. There is a bluestone terrace along the



Above: Looking southeast across step-stone revetments toward the pavilion, circa 1940.
(Source: Chicago Park District Records: Photographs, Chicago Public Library Special Collections)

Below: In 1965, the stone platform from north of the pavilion around the east side of the peninsula was replaced with a concrete platform with almost ninety concrete deflectors. (Photo by Gabriel Issa; Source: U-High Midway online, April 6, 2022)





Left: The David Wallach Fountain aligns with the 55th Street underpass. The Lakefront Trail passes directly in front of the fountain. (Source: Public Art in Chicago blog by Jyoti Srivastava)

Below: The circuit path surrounds the site's central meadow and loops around the eastern end of the Point. At the east end, a slightly narrower path bisects the meadow and links the north and south sides of the circuit path. A short curving pathway leads from the bisecting path east to the pavilion. (Photo by Zbigniew Bzdak; Source: *Chicago Tribune* online, January 27, 2016)



pavilion's eastern façade and a steep stairway leads from this terrace to the east side of the circuit path.

Promontory Point's landscape is sparser today than it was historically. When the site was first designed and implemented in the 1930s, the WPA provided the Chicago Park District with funding levels and labor forces that far surpassed subsequent periods. Additionally, increasing crime in the 1960s and 1970s prompted urban park departments throughout the nation, including the CPD, to eliminate shrub masses from public landscapes. However, Promontory Point is one of the nation's only historic landscapes in which a noteworthy original landscape architect returned more than fifty years after the site's creation to oversee its restoration.

CPD designers had first developed plans for Promontory Point's grading and general layout, including the pathway system, in 1935, prior to Alfred Caldwell's involvement. The implemented design largely follows this plan. When interviewed for a brochure published in 1987 celebrating the 50th anniversary of Promontory Point's creation, landscape architect Alfred Caldwell said that in producing Promontory Point's planting plan for that site, he sought to express "a sense of space and a sense of the power of nature and the power of the sea."

Caldwell created a landscape in the Prairie style for the newly infilled Promontory at 55th Street while work was still in progress to complete improvements. He designed a central meadow edged by canopy trees and dense understory plantings of smaller trees and shrubs. To take full advantage of the site's lakefront views, Caldwell created openings among the beds of trees and shrubs at the north and south sides of the Promontory to frame dramatic views in either direction, but elsewhere dense plantings helped to create a sense of enclosure. Caldwell explained that he created "two distinct experiences; the lofty meadow, from which the rocks along the water cannot be seen, and the rocks themselves, from which the meadow cannot be seen."

For the perimeter areas of Promontory Point's landscape, Caldwell envisioned four circular, layered-stone council rings with center hearth stones. Jens Jensen had incorporated such circular benches into many of his designs, including his Chicago masterpiece, Columbus Park. Jensen's stratified stonework was evocative of the limestone bluffs and outcroppings that edged natural Midwestern rivers, valleys, and canyons. Caldwell incorporated a stone council ring in his design for the Lincoln Park Lily Pool which he was working on concurrently between 1936 and 1938. Although that one was built as he had intended, the CPD did not approve plans for the stone council rings at the 55th Street Promontory. Instead, four streamlined concrete hexagonal benches with block-shaped center fire hearths were built in their place.

The Prairie style of landscape design had developed in the late nineteenth and early twentieth centuries. It was an approach that sought to honor the natural characteristics of the Midwest. Designs were meant to reflect the flat expanses of the prairies and the open character of the natural landscape. Native vegetation and other features of the Midwestern landscape were drawn upon and often incorporated directly into the designs.

As with Prairie School architecture, the emphasis was on the horizontal such that spaces were organized as a sequence of outdoor rooms and views. Trees and shrubs which branched horizontally were often used to frame particular views, emphasizing contrast. Water elements referenced lakes, streams, or wetlands. Layered limestone evoked the natural rock formations

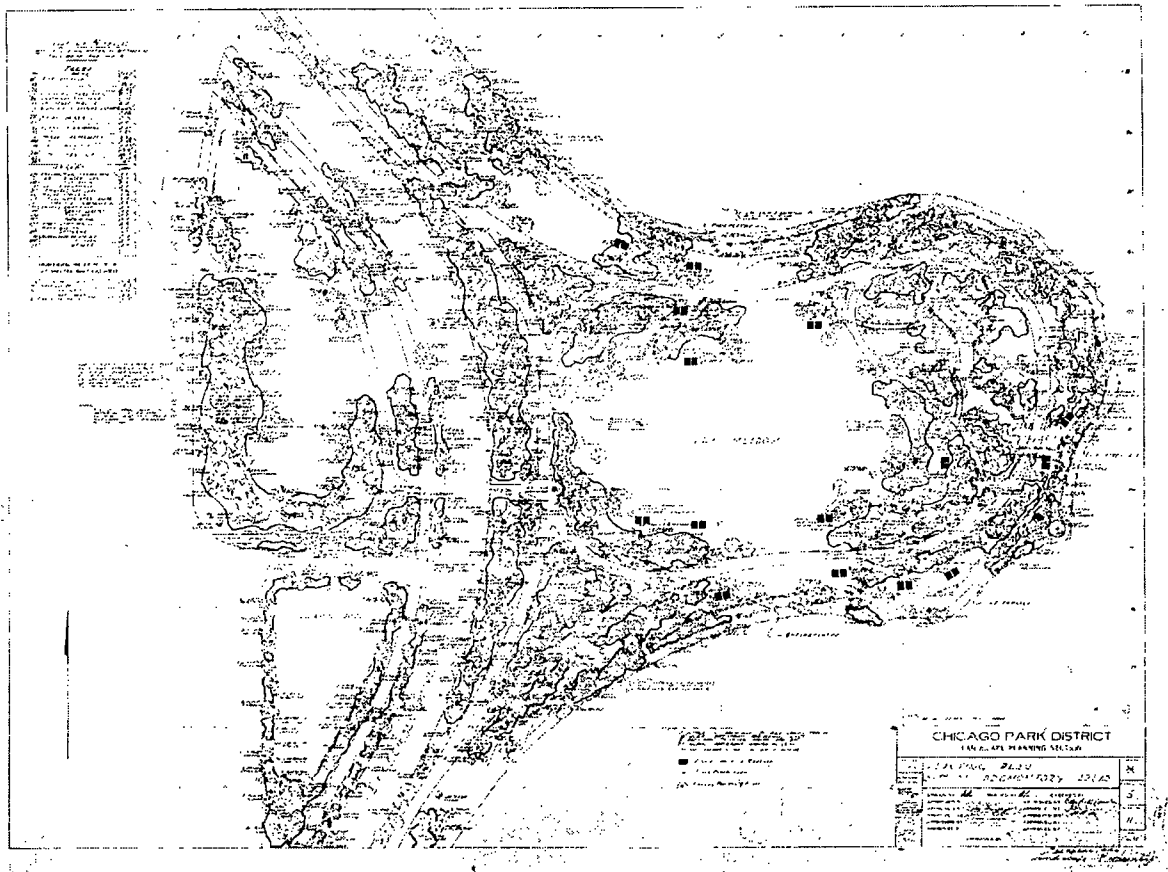

Above: "Planting Plan, 55th St. Promontory Areas," drawn and traced by Alfred Caldwell. Originally dated September 1, 1936. There are several revisions in this version, the first few signed off on by Caldwell who was with CPD through 1940: "Revised 9-18-37 Foundation/Planting/Building; Located benches May 19, 1938. A.C.; Located boulders March 2, 1939; Plantation around Wallach Mon. extended Nov. 2 '42; Located picnic tables 4-30-'53. B.S.A." (Source: Chicago Park District Records: Drawings, Chicago Public Library Special Collections)

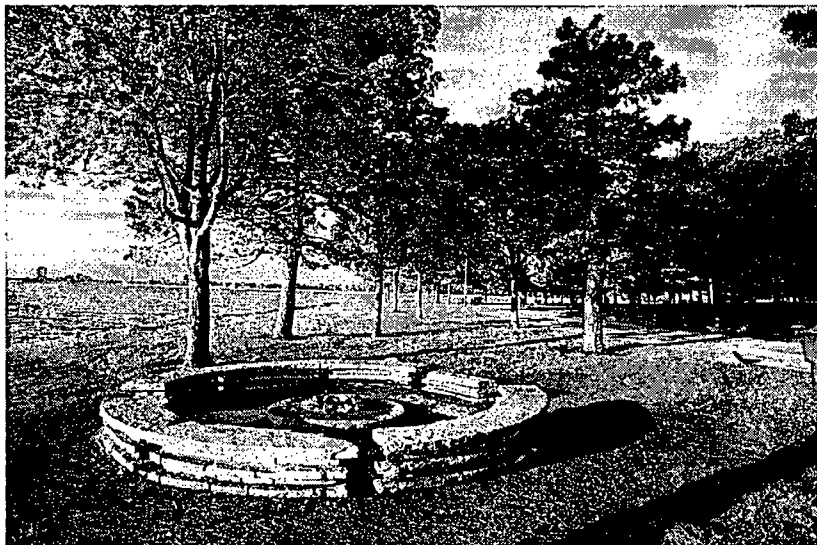

Left: Four council rings are visible on Caldwell's drawing above, but hexagonal concrete benches were built in their place. During the Point's 1989 restoration work, Caldwell worked with CPD staff to have the layered-stone circular benches with central hearths installed by his original vision. (Photo by Marc C. Monaghan.)

or glacial ridges of the Midwest, and it was utilized for paths, bridges, council rings, and other structures. Along with Ossian Cole Simonds and Jens Jensen, designers whose work also shaped Chicago's parks, Alfred Caldwell was one of the avowed leaders of this approach to landscape design.

The Pavilion

Set within the landscape is the Promontory Point pavilion, a combined comfort station and park shelter, designed by Emanuel V. Buchsbaum and his staff architects. The building is essentially V-shaped in plan, with two rectangular one-and-a-half-story wings. A round, four-story-tall tower stands at the interior angle of their intersection. In its original form, the north wing was an open shelter accessible via a series of openings on the east and west sides that fronted onto bluestone terraces. Bathrooms were housed in a smaller adjoining section at the north end. The south wing functioned as an indoor shelter with a fireplace on the south wall.

The gabled roofs of the wings and the conical roof of the tower are sheathed in a textured red tile. Topping the tower's conical tile roof, a bronze weathervane features a ship. The building is clad in rusticated ashlar Lannon stone set in a random pattern with corbeling at the cornice level of the tower. The stone ranges in color from pale beige to yellowish to tan.

The public structure reflected the French Eclectic style of architecture, one of many revival styles celebrated though not necessarily common in America during the 1920s and 1930s. Buildings in this style typically featured brick, stone, or stucco wall cladding and had tall, steeply pitched hipped roofs, or gabled roofs in the case of the towered subtype, without dominant front-facing cross gables. The towered subtype was asymmetric and had a round tower with a high, conical roof placed at the intersection of two gable-roofed wings. The principal entrance was typically located in the tower. Decorative half-timbering was often seen in this subtype, inspired by the farmhouses of the Normandy province of France.

The pavilion at Promontory Point did not employ typical, geometric-patterned half-timbering, but used oak beams on the exterior for a more simplified look. Thick oak lintels rising slightly to a center point are set above the entrances to the north wing while oak lintels are visible above all but one window of the north and south wings. On the tower, a second-floor balconette of "adzed oak" (oak hewn with a curved-blade axe called an adze) with a balustrade of diagonal crosses adds a decidedly rustic or medieval note. Directly below, the original paneled doors with multi-lite transoms are still in place at the primary entrance to the structure. Secondary entrances are found at the opposite side of the tower and on the east and west elevations of the comfort station at the north wing.

The towered subtype of the French Eclectic tended toward the picturesque and often included arched door openings and sometimes French doors, double-hung or casement sash windows, and roof or through-the-cornice dormers. The pavilion at Promontory Point incorporated many of these features. Windows were different configurations of casements and a few steel sash set into segmental, flat, or blind semi-circular arches, about half of which were within recessed bays. Two windows on the east and west sides of the comfort station were set into arched, through-the-cornice dormers. Fixed, round, multi-lite windows were centered on the gable ends of the north wing. The tower featured arched window openings (with three-lite windows added in the 1950s or 1960s) grouped in threes under the cornice and two small, rectangular, divided-light windows on lower floors. Doors opening onto the balconette are French doors.

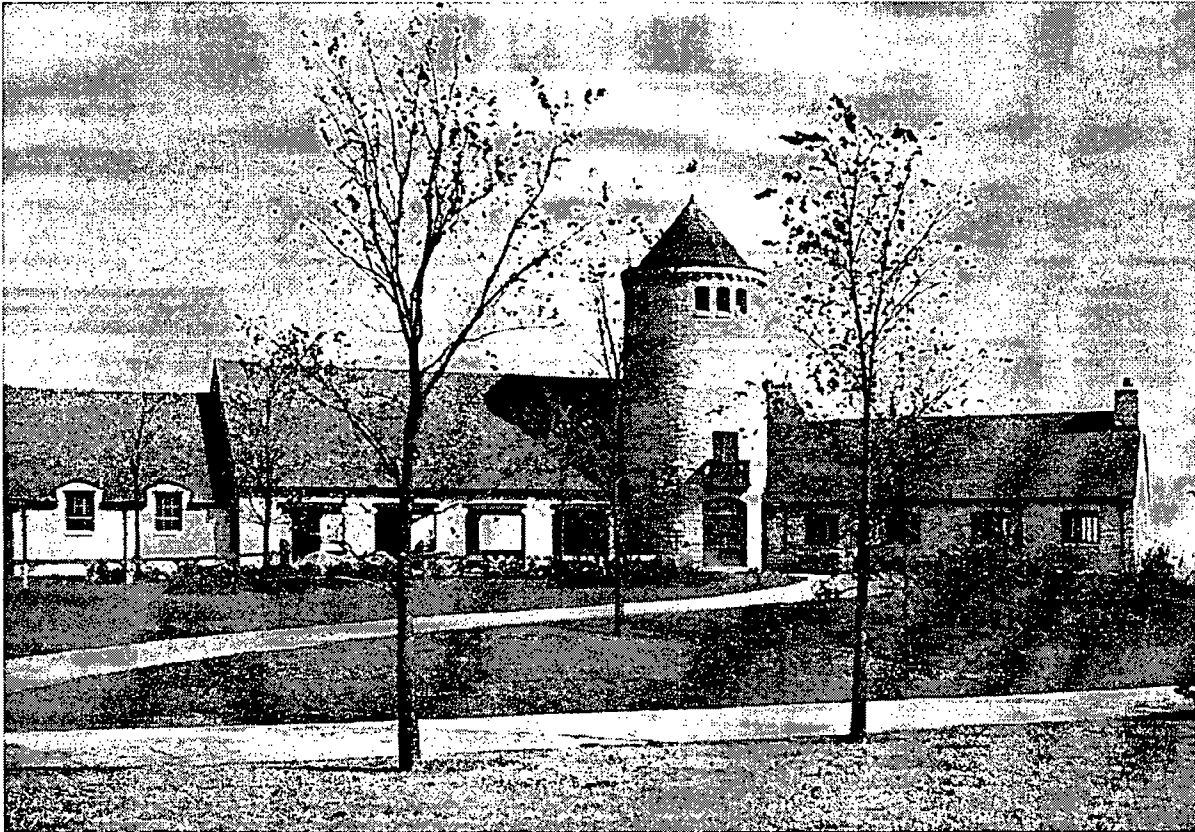

Above: Looking east at the Promontory Point pavilion, circa 1940. The north wing at left functions as an open breezeway without doors. (Chicago Park District Records: Photographs, Chicago Public Library Special Collections)

Below left: Looking northwest at the Promontory Point pavilion. (Source: Public Art in Chicago blog by Jyoti Srivastava). Below right: The weathervane atop the tower. (Photo by Michael Tercha; Source: *Chicago Tribune* online, August 13, 2014)

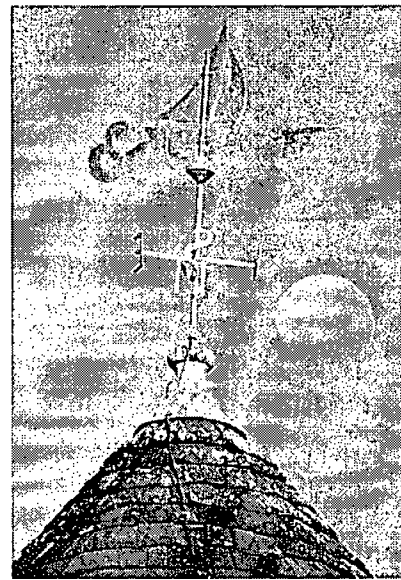

The height of the tower is where Promontory Point's pavilion is markedly different from the average French Eclectic tower subtype building. In these, tower structures typically were not much higher or lower than the highest cornice line. At Promontory Point, the tower is four stories tall. The pavilion is sited near the eastern edge of the promontory at the peninsula's highest and therefore most visible point and providing it with the greatest possible view. By designing a stone building with a stout but tall tower on the highest point of a promontory at water's edge, Buchsbaum and his staff referenced medieval castles one might see perched atop cliffs or other tall land masses at the edge of a body of water in Europe. People also associate the tower with another type of tall building located at the edge of a body of water, the lighthouse.

The David Wallach Fountain

Artists Frederick C. Hibbard and Elizabeth Haseltine Hibbard produced the *David Wallach Fountain* in 1939. Modernistic in form, the stacked geometric shapes comprising the base of the *David Wallach Fountain* are made of polished "Dakota Mahogany granite" from Minnesota according to the *Hyde Park Herald* in a 1993 article regarding the statue's re-dedication. Atop the upper circular portion is a bronze statue of a resting fawn with its legs tucked under its chin. A rounded water trough for animals extends forward at ground level from the front of the base and rectilinear drinking fountains project from the other three sides of the monument. "The David Wallach Fountain" is incised in the granite beneath the sculpture and simple Art Deco-style foliage carvings accent the circular section and drinking fountains.

Landscape Architect Alfred Caldwell

Considered a great twentieth-century landscape architect of the Prairie style, Alfred Caldwell (1903–1998) designed and later restored Promontory Point's landscape. In addition to Promontory Point, Caldwell's body of significant work includes Eagle Point Park in Dubuque, Iowa; Lafayette Park in Detroit, Michigan; Riis Park on Chicago's north side; and the Lily Pool in Chicago's Lincoln Park (a designated Chicago Landmark).

Born in St. Louis and raised in Chicago, Alfred Caldwell attended Lakeview High School, where he was inspired by his science teacher, Dr. Hermann Silas Pepoon, an accomplished botanist and author of *An Annotated Flora of the Chicago Region*. Aspiring to become a landscape architect, Caldwell worked various jobs to afford the tuition for the University of Illinois in Urbana-Champaign. After a brief period studying in the Landscape Architecture Department, however, he became disillusioned with its bias towards Beaux-Arts Classicism and dropped out.

In 1924, Caldwell went to see Jens Jensen, the famous landscape architect whom he had previously met through a family connection. Hiring Caldwell on the spot, Jensen soon provided the fledgling landscape architect with the vision, education, and guidance that he had been seeking. As a superintendent on job sites, Caldwell was responsible for landscape construction. Rather than strictly adhering to plans, Jensen expected decisions to be made in the field. Working closely with his esteemed employer, Caldwell came to understand the philosophies behind the Prairie style of Jensen's designs. Over approximately six years, Caldwell worked on such high-profile projects as the Edsel and Eleanor Ford Estate in Grosse Point Shores, Michigan, and the Harley Clark Estate in Evanston, Illinois. Jensen became Caldwell's close friend and mentor. During his tenure in Jensen's office, Caldwell also met acclaimed architect

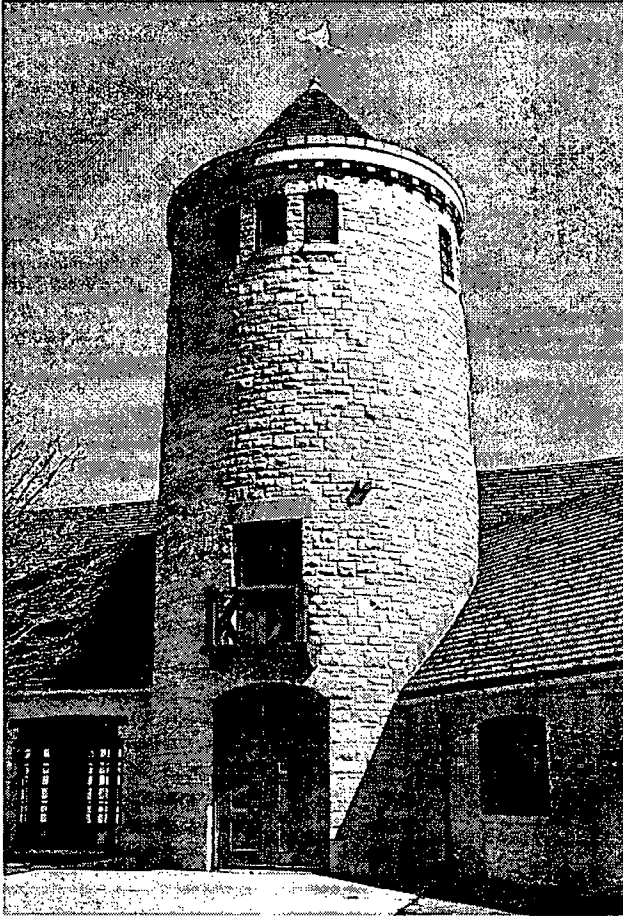

Left: The pavilion tower's rustic second-floor balconette has a balustrade of diagonal crosses. Directly below, the original paneled doors are still in place. Oak lintels are visible above the north wing door opening at left and the arched window at right. (Photo by Paul R. Burley via Wikimedia Commons)

Lower Left: At the base of the fountain is a water basin for animals. Fountains for people are at the left, right, and to the rear. (Source: Public Art in Chicago blog by Jyoti Srivastava)

Lower Right: Girls with their dog drinking from the basin, 1940. (Source: Chicago Park District Records: Photographs, Chicago Public Library Special Collections)

Below: The bronze statue of a resting fawn atop the *David Wallach Fountain*. (Source: Public Art in Chicago blog by Jyoti Srivastava)



Right: Alfred Caldwell, circa 1938. (Photo by Helen Balfour Morrison; Source: Shearer Foundation, Newberry Library)



Right: Water feature and stratified stonework, Eagle Point Park, Dubuque, Iowa, designed by Alfred Caldwell. (Photo by Julian Bachrach)



Below: The Lily Pool in Lincoln Park, Chicago, designed by Alfred Caldwell. (Source: The Cultural Landscape Foundation website)

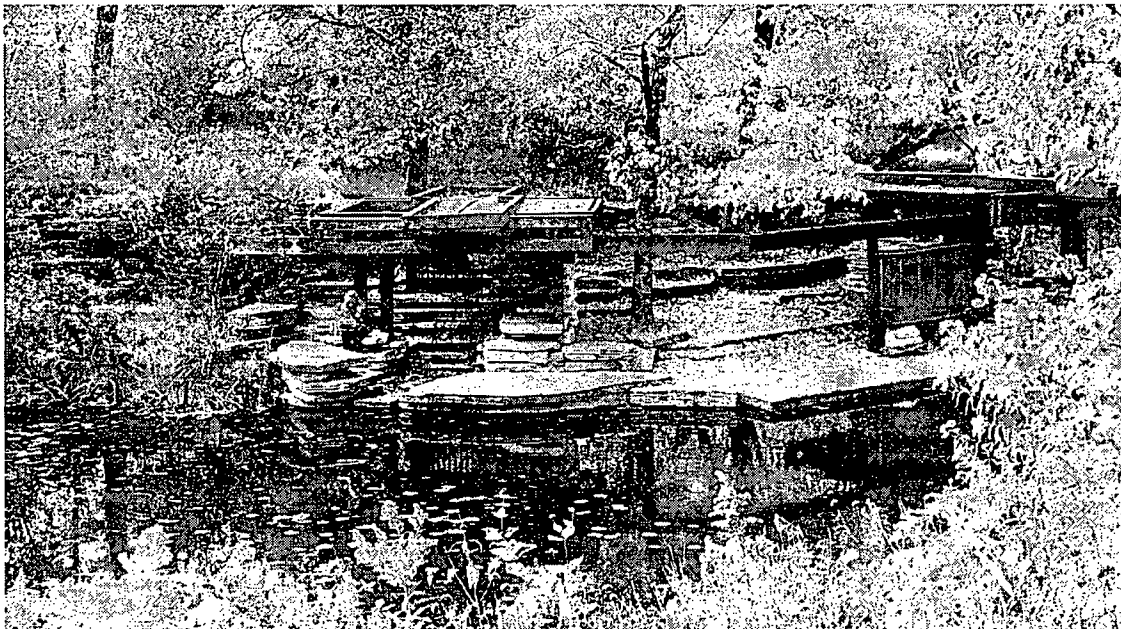

Frank Lloyd Wright, innovator of the Prairie School of architecture, who likewise became an important source of inspiration for his work.

By the early 1930s, Jensen did not have enough business to keep Caldwell on. As the Chicago Park District had begun receiving federal relief funds, Caldwell found employment there to assist with specific projects such as a new Japanese Garden in Jackson Park. Caldwell worked for the CPD from 1936 through 1940 with some brief interruptions. Despite his tumultuous relationship with CPD administrators, Caldwell accomplished much during these years. With the support of the WPA, the CPD completed tens of millions of dollars of improvements to the parks. Because of his knowledge of plants, his design skills, and his ability to produce detailed plans at an impressively fast pace, Caldwell's superiors put him in charge of the district's most ambitious and high-profile landscape projects. Altogether, he produced plans for approximately 1,000 acres of greenspace. Over an approximately four-year period, Alfred Caldwell's work included plans for Riis Park, the Lily Pool and landfill extensions from Montrose to Foster Avenues in Lincoln Park, various boulevards and stretches of what was then called Lake Shore Drive as well as Northerly Island, and the 55th Street Promontory (Promontory Point) in Burnham Park.

Architect Emanuel V. Buchsbaum

The Chicago Park District's head architect, Emanuel V. Buchsbaum (1907-1995), oversaw the design of the Promontory Point pavilion from 1936 to 1937. The son of Hungarian immigrants, Buchsbaum was born and raised in Chicago. While studying architecture at the Armour Institute (later renamed the Illinois Institute of Technology), Buchsbaum worked as a draftsman for the firm of Tallmadge and Watson. After graduating he worked as a draftsman for R. Harold Zook, a Chicago architect known for distinctive residential designs and Art Deco-style buildings. Rising to the position of architect and construction superintendent in Zook's office, Buchsbaum was involved in the design and construction of the Maine East High School and the Pickwick Theater in Park Ridge, Illinois.

By the summer of 1930, Zook had to lay Buchsbaum off due to lack of work caused by the Depression. Later that year Buchsbaum secured the position of architectural draftsman for Chicago's South Park District. He was responsible for all of the architectural work undertaken by the SPC. Buchsbaum's projects of that era included the Washington Park Bowling Green Building (nicknamed the Swiss Chalet), the Grant Park Band Shell (demolished in the 1970s), and the restoration of the Japanese Pavilion in Jackson Park (which coincided with the development of the Japanese Garden that Alfred Caldwell had worked on).

In 1934, when the city's independent park commissions were consolidated into the Chicago Park District, Buchsbaum became the CPD's Architectural Designer. In this position he oversaw a team of staff architects. Due to the difficulties of finding private sector work during the Depression, the CPD easily attracted talented, experienced professionals to these positions. Harvard graduate Frank G. Dillard, for example, was among the staff architects who worked with Buchsbaum on plans for the Promontory Point pavilion.

Buchsbaum left the CPD in 1941 to serve as Architectural Designer for the City of Chicago's Department of Subways and Superhighways. He remained in that position until 1943, and his work included collaboration with the firm of Shaw, Naess & Murphy on the Streamline Moderne design of the State Street Subway. In 1946, Buchsbaum returned to the CPD as an

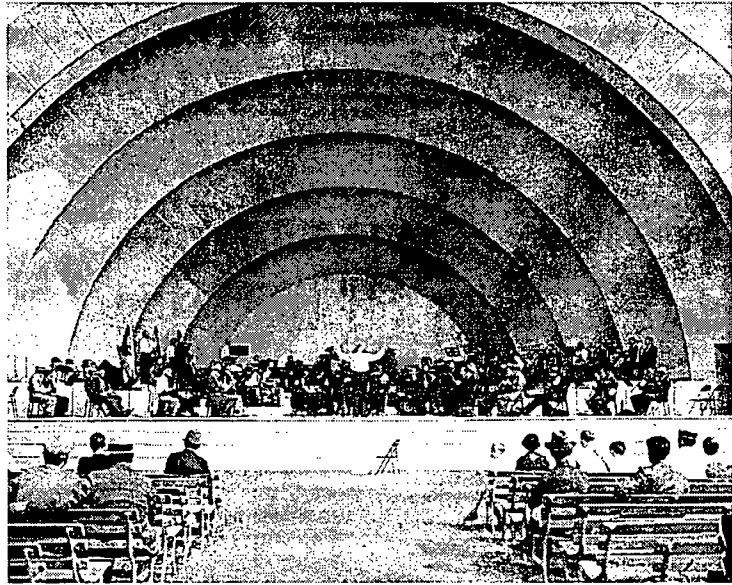

Clockwise from top:
Emanuel V.
Buchsbaum (Source:
McCallum Family);
Grant Park Band
Shell; North Avenue
Beach House
(demolished); Mont-
rose Avenue Beach
House (west wing ex-
tant) (Source: CPD);
Henry Horner Park
Field House (Source:
HHP Advisory Council)

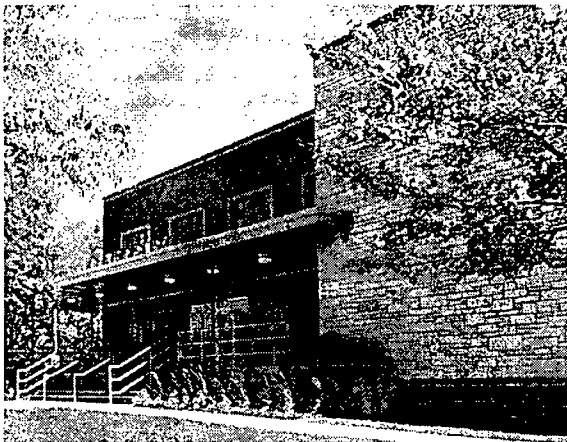

architect. In 1968, the CPD appointed him Assistant Engineer for Design and Contracts, a position he held until his retirement in the late 1970s. Buchsbaum's numerous CPD designs include the 1937 Art Moderne "lake steamer" Montrose Avenue Beach House (east wing demolished due to fire); the 1938 North Avenue Beach House (demolished in 1999); the 1936 Wilson Stone Comfort Station; the Farm in the Zoo Pavilion in Lincoln Park; English- and Colonial- style comfort stations in various locations including Jackson, Columbus, Humboldt, and Washington Parks; a stone shelter in Jackson Park known as the Iowa Building; and the 1956 Henry Horner Park Field House.

Sculptors Frederick C. and Elizabeth Haseltine Hibbard

In the late 1930s, heirs of South Side businessman David Wallach sued the city of Chicago. Wallach's will had stipulated that \$5,000 go to the city to build a fountain for "man and beast" near where he had lived at 33rd and King Drive as a gift to the working horses in his neighborhood. No fountain was built and the heirs, who lived on 55th Street near Promontory Point, received \$9,000 in interest and subsequently worked with the city to sponsor a design competition for a fountain to be built and installed at the park taking shape near their home.

Artists Frederick C. and Elizabeth Haseltine Hibbard won the contest. Although the monument never included a horse trough (there was no equestrian trail with access to Promontory Point), it was designed to have a bird bath doubling as a water basin for dogs as well as drinking fountains for children and adults. The Hibbards completed the project in 1939.

Born in Canton, Missouri, Frederick Cleveland Hibbard (1881-1950) attended the State University of Missouri and then moved to Chicago to study at the Armour Institute. His interest in sculpture led him to switch to the Art Institute where he became a protégé of the renowned sculptor Lorado Taft. Within a year, Hibbard became Taft's assistant. In 1904, Hibbard opened his own studio and quickly found success. One of his earliest commissions was a statue of Chicago Mayor Carter H. Harrison for Union Park. Altogether he created over seventy commissions nationwide, including statues in Hannibal, Missouri, of Mark Twain and his fictional characters Tom Sawyer and Huck Finn; and the *Abraham and Mary Todd Lincoln* Monument in Racine, WI, one of the first presidential sculptures to include the depiction of a first lady. Frederick Hibbard's major works in Chicago include the *Eagle Fountains* in Grant Park, the *Greene Vardiman Black Memorial* in Lincoln Park, the *Garden Figure* in the Lincoln Park Conservatory, and his 1926 low-relief sculptural panels of children at play installed on the north elevation of the Chicago Landmark Calumet Park Fieldhouse.

Elizabeth Haseltine Hibbard (1894–1950) was born in Portland, Oregon, and studied at the Portland Art School before moving to Chicago in 1917 to attend the University of Chicago. She went on to study at the School of the Art Institute of Chicago from 1921 to 1925. Specializing in sculptures of animals, she also received training at the *Ecole d'Art Animalier* and the *Academie de la Grande Chaumiere* in Paris. Frederick and Elizabeth Hibbard were married in 1931. They resided on Chicago's South Side.

In addition to frequently exhibiting her work, which won many prizes, Elizabeth Haseltine Hibbard taught at the University of Chicago starting in 1922 and at the Art Institute between 1927 and 1932. She was among the artists chosen to exhibit sculpture at the American art exhibition of the 1933 Century of Progress World's Fair in Chicago. Her permanent installations include two bas reliefs of Pan figures in Norton Memorial Hall in Chautauqua,



Clockwise from top: Frank Hibbard in his studio sculpting Tom Sawyer and Huck Finn circa 1925; Elizabeth Haseltine Hibbard working on fawn sculpture, 1939 (Source: Promontory Point Conservancy website); Frank and Elizabeth Haseltine Hibbard pose with the model that won the *David Wallach Fountain* contest (Source: CPD website); *Eagle Fountain* in Congress Plaza (one of two) by Frank Hibbard, 1931 (Source CPD website); *Pan* bas relief from proscenium arch in Norton Memorial Hall, Chautauqua, NY, by Elizabeth Haseltine, 1928 (Source: *Western Architect* Magazine, February 1930); *Greene Vardiman Black Memorial* in Lincoln Park by Frank Hibbard, 1918 (Source: Public Art in Chicago blog by Jyoti Srivastava)

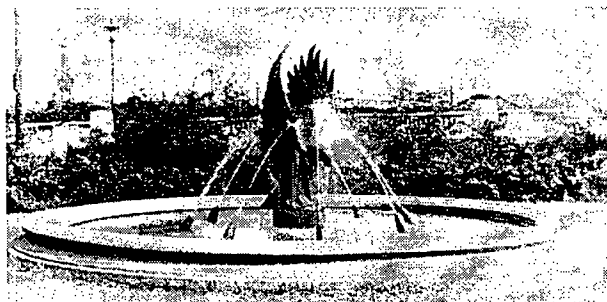

New York; *Baby Pegasus* at the Illinois State Art Museum; and *Baby Centaur* at the Vanderpoel Memorial Art Gallery at Ridge Park in Chicago. She also produced several animal sculptures for the Japanese Garden in Chicago's Jackson Park that no longer exist. Elizabeth Haseltine Hibbard worked on the fawn sculpture for the *Wallach Fountain* at the Lincoln Park Zoo, modeling the artwork on a doe in the zoo.

Promontory Point's Later History

As soon as the CPD opened the 55th Street Promontory for public use in 1939, it became a beloved community greenspace. Families, church groups, YMCA and YWCA social clubs, University of Chicago student organizations, and other civic clubs used the park for picnics and gatherings. In the 1940s, USO events and other social activities that provided entertainment to servicemen were held in the park. By the late 1940s, the community had nicknamed the site Promontory Point.

In 1953, during the Cold War, the federal government selected Chicago as one of several cities where Nike Missiles and related equipment would be installed. A number of lakefront park locations were earmarked as Nike sites. The United States military installed a missile launcher area in Jackson Park and a radar area at Promontory Point. A large portion of the meadow south of the pavilion was fenced off and several tall radar towers were erected within this restricted area.

Community organizations resented the installation of radar towers for the nearby Nike missile base in Jackson Park. Hyde Park Alderman Leon Despres and Congressman Barratt O'Hara supported the community's position, but the towers remained. As the anti-Vietnam War movement grew, community members became more ardent in their demands for the removal of Promontory Point's Nike installation. In 1970, U.S. Congressman Abner Mikva led 500 demonstrators who protested the Vietnam War and demanded the removal of the Nike missile bases. The federal government finally closed Promontory Point's Nike site in 1971, and, by 1974, all of the Chicago sites had been decommissioned.

Alterations and Restoration

From 1910 to 1931, shoreline protection structures integrating limestone step-stone revetments were installed along major stretches of the lakefront from Montrose Avenue to 56th Street as part of the addition of greenspace along the lakeshore. Those north of 43rd Street have since been replaced with concrete stair-step revetment, so Promontory Point retains some the city's last largely intact tiered limestone revetments. They are far from pristine, however. Once-neat tiers of limestone block have frayed, some have been replaced by or covered with concrete, while others are buried beneath piles of rip-rap stone. This is true for all of the revetment along the north and east edges of the point, though less so for the southern edge. At the very southern end of Promontory Point near East 56th Street, existing revetments were removed and replaced with steel sheet piling and rip-rap stones. A concrete platform and ramp were installed to provide wheelchair access to the 57th Street Beach in Jackson Park.

By the 1980s, the pavilion and the park's landscape were suffering from deterioration. The CPD undertook renovations of both. Alfred Caldwell, who was then in his late eighties, agreed

Right: Air Force and Navy cadets enjoying Promontory Point, circa 1942. These limestone steps on the east side of the pavilion have been replaced with concrete stairs. (Source: University of Chicago Library, Special Collections Research Center)



Below: Civil rights activist Al Raby (center) speaking at a Fourth of July event organized by the Hyde Park Peace Council, circa 1969. Congressman Abner Mikva sits to the right of Raby. In the distance are the radar towers of the Nike installation at the south end of Promontory Point (Source: University of Chicago Library, Special Collections Research Center)

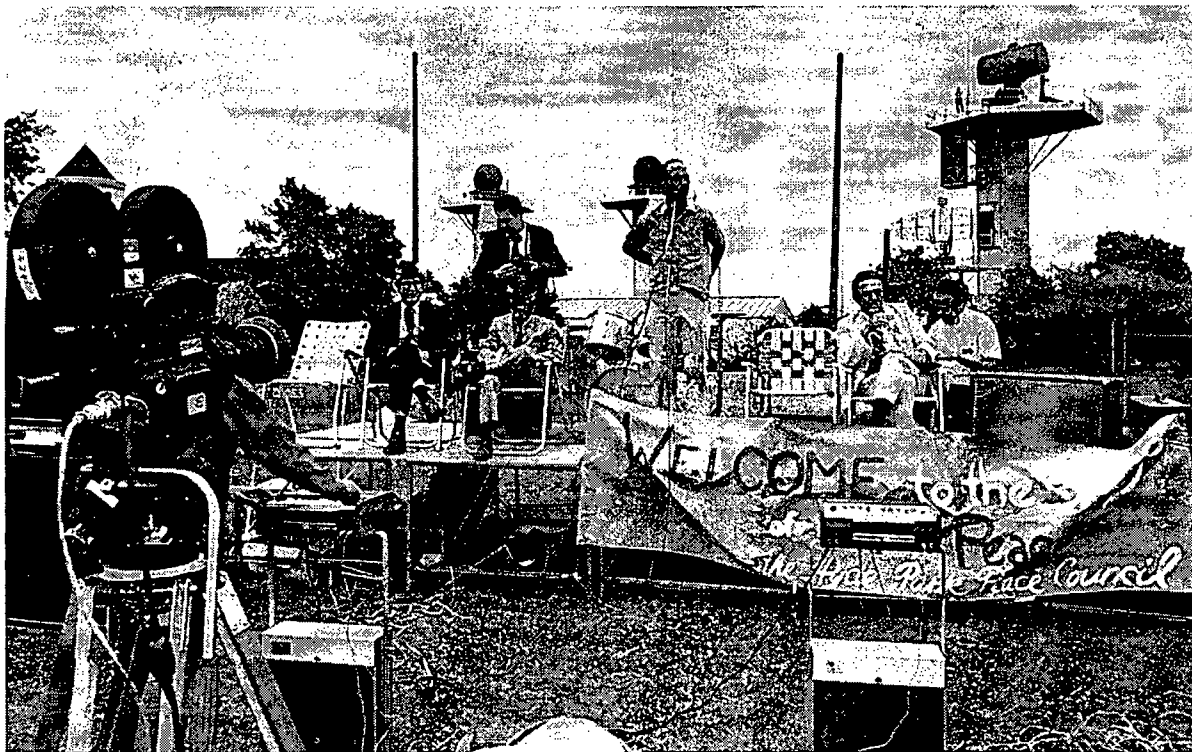

to consult on the proposed landscape restoration project. During the initiative, completed in 1989, Caldwell worked with CPD landscape architects to replace the site's concrete hexagonal benches with the kind of layered-stone council rings that he had originally envisioned.

Caldwell also assessed the existing plantings and found that some historic trees still thrived but most of the understory plantings had not. He and CPD designers created a re-planting scheme that included hundreds of native shade and ornamental trees, most of which had been part of his original plan or were substitutions selected under his guidance. Throughout the 1990s and early 2000s, the Chicago Park District continued planting additional trees from this list.

From 1990-1991, the CPD undertook a restoration of the pavilion's exterior combined with rehabilitation of the interior to allow for year-round use. Exterior work included masonry work, repair and replacement of ceramic roof tiles, and preservation of original windows. Existing openings into the north "breezeway" wing of the pavilion were filled in with French doors designed to match the original doors overlooking the tower balcony.

Criteria for Designation

According to the Municipal Code of Chicago (Sect. 2-120-690), the Commission on Chicago Landmarks has the authority to make a recommendation of landmark designation for an area, district, place, building, structure, work of art, or other object within the City of Chicago if the Commission determines it meets two or more of the stated “criteria for landmark designation,” as well as possesses sufficient historic integrity to convey its significance. The following should be considered by the Commission on Chicago Landmarks in determining whether to recommend that Promontory Point be designated as a Chicago Landmark:

Criterion #1: Value as an Example of City, State, or National Heritage

Its value as an example of the architectural, cultural, economic, historic, social, or other aspect of the heritage of the City of Chicago, State of Illinois, or the United States.

Promontory Point was first envisioned as part of Daniel Burnham’s seminal 1909 *Plan of Chicago* which proposed the use of artificial fill to construct a magnificent stretch of new parkland between Grant and Jackson Parks.

In 1934, Chicago voters approved the Park Consolidation Act, thereby establishing the Chicago Park District and, with it, the means to access money through the Works Progress Administration (WPA), President Roosevelt’s New Deal program to provide work to millions of jobseekers through the completion of public works programs. The Chicago Park District secured WPA funds from 1935 through 1939 to complete Promontory Point, employing thousands of Chicagoans during the Great Depression while creating a new peninsular park which provided South Siders with a beautiful haven just steps from Jean-Baptiste Pointe DuSable Lake Shore Drive with spectacular views and access to the lake.

In 1953, during the Cold War, the United States military installed a Nike missile launcher area in Jackson Park and a radar area at Promontory Point. Although some community organizations resented the installation of radar towers and were supported by Hyde Park Alderman Leon Despres and Congressman Barratt O’Hara, it was not until the anti-Vietnam War movement grew that community members became more ardent in their demands for removal of the structures. In 1970, U.S. Congressman Abner Mikva led 500 demonstrators who protested the Vietnam War and demanded the removal of the Nike missile bases. The federal government finally closed Promontory Point’s Nike site in 1971.

Criterion 4: Important Architecture

Its exemplification of an architectural type or style distinguished by innovation, rarity, uniqueness, or overall quality of design, detail, materials, or craftsmanship.

Promontory Point is a significant example of Alfred Caldwell’s Prairie style of landscape architecture.

Promontory Point’s pavilion is a fine French Eclectic-style building produced by Emanuel V. Buchsbaum, a noteworthy Chicago architect.

Promontory Point retains the city’s last largely intact stretch of limestone step-stone revetments, variations of which once defined most of Chicago’s shoreline during the twentieth century.

Criterion #5: Work of a Significant Architect or Designer

Its identification as the work of an architect, designer, engineer, or builder whose individual work is significant in the history or development of the City of Chicago, State of Illinois, or the United States.

Alfred Caldwell, landscape designer of Promontory Point, was mentored by Jens Jensen and is considered to be one of the great landscape architects of the Prairie style. This naturalistic approach to landscape design developed in the late nineteenth and early twentieth centuries and used native vegetation and other features of the Midwest to emphasize the region's open character and horizontal expanses.

Emanuel Valentine Buchsbaum, architect of the Promontory Point pavilion, was a notable Chicago architect. Buchsbaum's career began under architect R. Harold Zook with projects including the Maine East High School and the Pickwick Theatre in Park Ridge, Illinois. During the 1930s to 1970s while head architect and later an engineer for the Chicago Park District, Buchsbaum built structures throughout Chicago's park system, some of the most noteworthy being the 1931 Grant Park Band Shell (demolished 1978), the 1938 Art Moderne "lake steamer" North Avenue Beach House (demolished 1999) and 1937 Montrose Avenue Beach House (west wing extant), and the 1956 Henry Horner Park Field House.

Frederick C. and Elisabeth Haseltine Hibbard, sculptors of the *David Wallach Fountain*, were important Chicago artists whose sculptural work was exhibited and installed throughout the United States.

Criterion #7: Unique or Distinctive Visual Feature

Its unique location or distinct physical appearance or presence representing an established and familiar visual feature of a neighborhood, community, or the City of Chicago.

With its distinctive curved landform that juts out into Lake Michigan and its stepped limestone revetments that provide park visitors close access to the water, Promontory Point is an iconic visual feature along Chicago's lakefront.

Integrity Criterion

The integrity of the proposed landmark must be preserved in light of its location, design, setting, materials, workmanship and ability to express its historic community, architectural, or aesthetic interest or value.

A 40-acre peninsula of "made land" at the south end of Burnham Park, Promontory Point retains a high degree of historic integrity. It remains a distinctive lakefront location and the Buchsbaum-designed, French Eclectic-style pavilion and sculptural fountain designed by the Hibbards maintain their original design forms and the majority of their historic materials. Few of the original shrubs and trees remain from the 1930s Caldwell-designed landscape, but the

basic features and open spirit of the design remain, and missing elements were installed when Caldwell consulted with CPD in 1989. The park's stepped limestone revetments are damaged and portions have been replaced with or covered by concrete or rip-rap stone, but it remains the last stretch of largely intact limestone step-stone revetments in Chicago.

Significant Historical and Architectural Features

Whenever a building, structure, object, or district is under consideration for landmark designation, the Commission on Chicago Landmarks is required to identify the "significant historical and architectural features" of the property. This is done to enable the owners and the public to understand which elements are considered most important to preserve the historical and architectural character of the proposed landmark. Based upon its evaluation of Promontory Point, the Commission staff recommends that the significant features be identified as follows:

- All exterior elevations and roofline of the Pavilion Building; and
- The pathways, council rings, *David Wallach Fountain*, and limestone revetments; and
- Alfred Caldwell's landscape design of a central meadow edged by irregular groupings of plants and trees.

Routine landscape maintenance is excluded from review. Species selection of individual plants and trees is also excluded from review in recognition of the potential need for change to the plant palette to ensure that the park landscape is resilient in the face of climate change.

Selected Bibliography

- Akers, Dwight L, ed. *The City Club Bulletin*, Vol. VI, No. 15, Chicago: City Club of Chicago, December 16, 1913.
- American Institute of Architects. *American Architects Directory*. New York: American Institute of Architects, 1956, 1962, and 1970.
- Art Inventories Catalog of the Smithsonian Art Museum. Accessed online in the Smithsonian Institution Research Information System.
- Bachrach, Julia S. *The City in a Garden: A History of Chicago's Parks*, second edition. Chicago: Center for American Places at Columbia College, 2012.
- . "Daniel H. Burnham and Chicago's Parks." Accessed at <https://www.chicagoparkdistrict.com/sites/default/files/images/page/burnham.pdf>.
- . "National Historic Landmark Nomination: Lincoln Park Lily Pool." United States Department of the Interior, National Park Service. December 2004.
- . "National Register of Historic Places, Registration Form: Promontory Point." United States Department of the Interior, National Park Service. July 31, 2017.
- "Birds-Eye View of South Shore 'Made Land,' Following Mr. Burnham's Plan." *Chicago Tribune*, April 5, 1897.
- Brotman, Barbara. "Designer's '37 Park Plan Blossoms At Last." *Chicago Tribune*, June 6, 1989.
- Buchsbaum, Emanuel V. "Architectural Activities of the Chicago Park District." *Illinois Society of Architects Monthly Bulletin*, Vol. 20, No. 10-11, April-May 1936.
- . Personal Papers, Typewritten list of positions and salaries with a heading written in pencil "CPD Feb. 22, 1938." Located in archival box entitled Buchsbaum, Chicago Park District Special Collections, 1938.
- Burnham, Daniel H. and Edward H. Bennett. *Plan of Chicago*, centennial edition. Chicago: Commercial Club of Chicago, 1909 (reprinted 2009).
- Caldwell, Alfred. Interview by Julia Sniderman and Robert Grese, January 31, 1987.
- . "Oral History of Alfred Caldwell." Interview by Betty Blum, Art Institute of Chicago, 1987.
- Chicago Department of Transportation. "Shoreline History." Accessed at <https://www.chicago.gov/content/dam/city/depts/cdot/ShorelineHistory.pdf>.
- Chicago Park District. "Annual Report of the Chicago Park District, 1936-1940."
- Chicago Park District Records: Photographs, Chicago Public Library Special Collections.
- Chicago Park District Records: Plans and Drawings, Chicago Public Library Special Collections.
- Chrzastowski, Michael J. "Make No Little Plans: Field Trip Guidebook for the American Shore & Beach Preservation Association 2008 National Conference." Illinois State Geological Survey, University of Illinois at Urbana-Champaign, 2008.
- "Compile Roster of City's WPA Park Projects." *Chicago Tribune*, November 27, 1935, p. 2.
- Cultural Landscape Foundation. "Burnham Park." Accessed online at www.tclf.org.
- Domer, Dennis. "Alfred Caldwell: The Last Master." *Inland Architect*, Volume 116, 1999.
- Domer, Dennis, ed. *Alfred Caldwell: The Life and Work of a Prairie School Landscape Architect*. Baltimore, MD: The Johns Hopkins Press, 1997.
- Drake, Rebecca Blackwell. "Frederick C. Hibbard: Master Sculptor Part II." Accessed at <http://battleofraymond.org/history/hibbard1.htm>.
- "Elizabeth Haseltine Hibbard." *College Art Journal*, Vol. 10, No. 2 (Winter, 1951), p. 181.
- Epperson, Michael, Ph.D. "Army Air Defense Command, Nike Missile Site C-41, Promontory Point, Jackson Park, Chicago, 1955 - 1971." Accessed at <http://ed-thelen.org/C-41-Epperson/>.

- Foust, Hal. "Superhighway Idea to Rule in Burnham Park, South Side Outer Drive Dramatizes Advantages." *Chicago Tribune*, March 14, 1935, p. 2.
- "Frederick Cleveland Hibbard." Artist Auction Records. Accessed at https://www.askart.com/artist/Frederick_Cleveland_Hibbard/62125/Frederick_Cleveland_Hibbard.aspx.
- Grese, Robert E. *Jens Jensen: Maker of Natural Parks and Gardens*. Baltimore: Johns Hopkins University Press, 1998.
- Hanks, Nancy. "Landmark Designation Report: Alfred Caldwell Lily Pool." City of Chicago, Department of Planning and Development, Preliminary Landmark recommendation approved by the Commission on Chicago Landmarks, May 2, 2002.
- Hirschman, Carol. "Plans to Renovate the Point are Shaping Up." *Hyde Park Herald* (Chicago), March 25, 1987.
- . "Point Plans Will Take Park Back to Its Beginnings." *Hyde Park Herald* (Chicago), June 7, 1989, p. 7.
- "The History of Chicago's Famous Lake Shore Drive." Digital Research Library of Illinois History Journal. Accessed at <https://drloihjournal.blogspot.com/>.
- "The Lake-Front Scheme." *Chicago Tribune*, October 12, 1896.
- McAlester, Virginia & Lee. *A Field Guide to American Houses*. New York: Knopf, 1994.
- McDermott, John Jr. and Victoria Post Ranney, eds. "Promontory Point: Lake Michigan at 55th Street 1937-1987." Brochure. Chicago: Friends of the Parks and Hyde Park Historical Society, 1987.
- Morse, Patricia L. "Hyde Park Stories: The David Wallach Fountain." Hyde Park Historical Society Newsletter, July 2022.
- Norton, Cynthia. "Norton Memorial Hall." Brochure for Chautauqua Institute, June 2017. Accessed at <https://www.chq.org/wp-content/uploads/2021/01/nortonhall.pdf>.
- Perry, Susan. "Landmark Designation Report: Calumet Park Fieldhouse, 9801 Avenue G." City of Chicago, Department of Planning and Development, Preliminary Landmark recommendation approved by the Commission on Chicago Landmarks on March 2, 2006.
- Reiff, Janice L., Ann Durkin Keating, and James R. Grossman, editors. "Encyclopedia of Chicago." Chicago History Museum, The Newberry Library, and Northwestern University, copyright 2005. <http://encyclopedia.chicagohistory.org/>.
- Rolfe, Mary A. "Norton Memorial Hall." *The Western Architect*, Vol. XXXIX, January-December 1930, p. 26.
- Schlarman, Julie. "National Register of Historic Places Registration Form: Eagle Point Park Historic District, 2601 Shiras Avenue, Dubuque, IA." United States Department of the Interior, National Park Service. 2017.
- Sideman, Robert A. "Welcome to the Point: the David Wallach Fountain." *Hyde Park History* published by the Hyde Park Historical Society, Vol. 41, Nos. 1-3, Autumn 2019.
- Smith, Carl. *The Plan of Chicago: Daniel Burnham and the Remaking of the American City*. Chicago: University of Chicago Press, 2006.
- Sniderman, Julia, Bart Ryckbosch, and Laura Taylor. "National Register of Historic Places, Registration Form: Lincoln Park, 2045 Lincoln Park West, Chicago, IL." United States Department of the Interior, National Park Service, March 3, 1994.
- South Park Commissioners. "Annual Report of the South Park Commissioners for the Fiscal Year Ending February 28, 1922."
- "Southern Area to Benefit by WPA Projects." *Chicago Tribune*, May 29, 1938, p. 19.
- "WPA Aids South Side Projects with \$547,000." *Chicago Tribune*, February 14, 1937, p. 43.



Midway USO event at Promontory Point, circa 1942. (Source: University of Chicago Library, Special Collections Research Center)



(Photo by Zbigniew Bzdak;
Source: *Chicago Tribune* online,
June 16, 2020)



**People enjoying the easy
access to water from Prom-
ontory Point.**

(Photo by Michael Tercha;
Source: *Chicago Tribune* online,
March 21, 2011)



(Photo by Zbigniew Bzdak;
Source: *Chicago Tribune* online,
June 27, 2012)

ACKNOWLEDGMENTS

CITY OF CHICAGO

Lori E. Lightfoot, Mayor

Department of Planning and Development

Maurice D. Cox, Commissioner

Kathleen Dickhut, Deputy Commissioner, Bureau of Citywide Systems & Historic Preservation

Project Staff

Kandalyn Hahn (project manager), editing, research, writing, and layout

Matt Crawford, editing

Thanks to the Promontory Point Conservancy for providing an initial report by Julia S. Bachrach.

The Commission on Chicago Landmarks, whose nine members are appointed by the Mayor and City Council, was established in 1968 by city ordinance. The Commission is responsible for recommending to the City Council that individual building, sites, objects, or entire districts be designated as Chicago Landmarks, which protects them by law. The Commission is staffed by the Chicago Department of Planning and Development; Bureau of Citywide Systems, Historic Preservation & Central Area Planning, City Hall, 121 North LaSalle Street, Room 905, Chicago, IL 60602; (312-744-3200) phone; web site: <https://www.chicago.gov/city/en/depts/dcd/provdrs/hist.html>

This Landmark Designation Report is subject to possible revision and amendment during the designation process. Only language contained within a designation ordinance adopted by the City Council should be regarded as final.

COMMISSION ON CHICAGO LANDMARKS

Ernest C. Wong, Chair

Gabriel Ignacio Dziekiewicz, Vice-Chair

Maurice D. Cox, Secretary

Suellen Burns

Jonathan Fair

Tiara Hughes

Alicia Ponce

Adam Rubin

Richard Tolliver

The Commission is staffed by the:



Historic Preservation Division

Bureau of Citywide Systems and Historic Preservation

City Hall, 121 North LaSalle Street, Room 1000

Chicago, Illinois 60602

312.744.3200 (TEL)

<http://www.cityofchicago.gov/dpd>

March 2023

ORDINANCE

Promontory Point

East of S. Jean-Baptiste Pointe DuSable Lake Shore Drive Between 54th and 56th Streets

WHEREAS, pursuant to the procedures set forth in the Municipal Code of Chicago (the "Municipal Code"), Sections 2-120-620 through -690, the Commission on Chicago Landmarks (the "Commission") has determined that Promontory Point, specifically that portion located east of S. Jean-Baptiste Pointe DuSable Lake Shore Drive between 54th and 56th Streets, Chicago, Illinois, as more precisely described in **Exhibit A**, attached hereto and incorporated herein (the "Site"), satisfies four (4) criteria for landmark designation as set forth in Section 2-120-620 (1), (4), (5), and (7) of the Municipal Code; and

WHEREAS, the Site was first envisioned as part of Daniel Burnham's seminal 1909 *Plan of Chicago* which proposed the use of artificial fill to construct a magnificent stretch of new parkland between Grant and Jackson Parks; and

WHEREAS, in 1934, Chicago voters approved the Park Consolidation Act, thereby establishing the Chicago Park District and, with it, the means to access money through the Works Progress Administration (WPA), President Roosevelt's New Deal program to provide work to millions of jobseekers through the completion of public works programs. The Chicago Park District secured WPA funds from 1935 through 1939 to complete the Site, employing thousands of Chicagoans during the Great Depression while creating a new peninsular park which provided South Siders with a beautiful haven just steps from Jean-Baptiste Pointe DuSable Lake Shore Drive with spectacular views and access to the lake; and

WHEREAS, in 1953, during the Cold War, the United States military installed a Nike missile launcher area in Jackson Park and a radar area at the Site. Although some community organizations resented the installation of radar towers and were supported by Hyde Park Alderman Leon Despres and Congressman Barratt O'Hara, it was not until the anti-Vietnam War movement grew that community members became more ardent in their demands for removal of the structures. In 1970, U.S. Congressman Abner Mikva led 500 demonstrators who protested the Vietnam War and demanded the removal of the Nike missile bases. The federal government finally closed the Site's Nike installation in 1971; and

WHEREAS, Alfred Caldwell, landscape designer of the Site, was mentored by Jens Jensen and is considered to be one of the great landscape architects of the Prairie style. This naturalistic approach to landscape design developed in the late nineteenth and early twentieth centuries and used native vegetation and other features of the Midwest to emphasize the region's open character and horizontal expanses; and

WHEREAS, the Site's Pavilion Building is a fine French Eclectic-style building designed by Emanuel Valentine Buchsbaum, a notable Chicago architect. Buchsbaum's career began under architect R. Harold Zook with projects including the Maine East High School and the Pickwick Theatre in Park Ridge, Illinois. During the 1930s to 1970s while head architect and later

an engineer for the Chicago Park District, Buchsbaum built structures throughout Chicago's park system, some of the most notable being the 1931 Grant Park Band Shell (demolished 1978), the 1937 Art Moderne "lake steamer" Montrose Avenue Beach House (west wing extant) and 1938 North Avenue Beach House (demolished 1999), and the 1956 Henry Horner Park Field House; and

WHEREAS, Frederick C. and Elisabeth Haseltine Hibbard, sculptors of the *David Wallach Fountain*, installed and dedicated at the Site in 1939, were important Chicago artists whose sculptural work was exhibited and installed throughout the United States; and

WHEREAS, the Site is a significant example of Alfred Caldwell's Prairie style of landscape architecture; and

WHEREAS, the Site retains the city's last largely intact stretch of limestone step-stone revetments, variations of which once defined most of Chicago's shoreline during the twentieth century; and

WHEREAS, with its distinctive curved landform that juts out into Lake Michigan and its stepped limestone revetment that provides park visitors close access to the water, Promontory Point is an iconic visual feature along Chicago's lakefront; and

WHEREAS, consistent with Section 2-120-630 of the Municipal Code, the Site has a significant historic, community, architectural, or aesthetic interest or value, the integrity of which is preserved in light of its location, design, setting, materials, workmanship, and ability to express such historic, community, architectural, or aesthetic interest or value; and

WHEREAS, on March 9, 2023, the Commission adopted a resolution recommending to the City Council of the City of Chicago (the "City Council") that the Site be designated a Chicago Landmark; now, therefore,

BE IT ORDAINED BY THE CITY COUNCIL OF THE CITY OF CHICAGO:

SECTION 1. The above recitals are hereby adopted as the findings of the City Council.

SECTION 2. The Site is hereby designated a Chicago Landmark in accordance with Section 2-120-700 of the Municipal Code.

SECTION 3. For purposes of Sections 2-120-740 and 2-120-770 of the Municipal Code governing permit review, the significant historical and architectural features of the Site are identified as:

- All exterior elevations and roofline of the Pavilion Building; and
- The pathways, council rings, *David Wallach Fountain*, and limestone revetments; and
- Alfred Caldwell's landscape design of a central meadow edged by irregular groupings of plants and trees.

Routine landscape maintenance is excluded from review. Species selection of individual plants and trees is also excluded from review in recognition of the potential need for change to the plant palette to ensure that the park landscape is resilient in the face of climate change.

SECTION 4. The Commission is hereby directed to create a suitable plaque appropriately identifying the Site as a Chicago Landmark.

SECTION 5. If any provision of this ordinance shall be held to be invalid or unenforceable for any reason, the invalidity or unenforceability of such provision shall not affect any of the other provisions of this ordinance.

SECTION 6. All ordinances, resolutions, motions, or orders in conflict with this ordinance are hereby repealed to the extent of such conflict.

SECTION 7. This ordinance shall take effect upon its passage and approval.

EXHIBIT A

Site Address:

Portion of Promontory Point located east of S. Jean-Baptiste Pointe DuSable Lake Shore Drive
Between 54th and 56th Streets

Permanent Index Numbers:

PIN # 20-12-109-001-0000 (part of)

PIN # 20-13-104-001-0000 (part of)