



City of Chicago



O2020-2836

Office of the City Clerk

Document Tracking Sheet

Meeting Date:	5/20/2020
Sponsor(s):	Reilly (42)
Type:	Ordinance
Title:	Grant(s) of privilege in public way for Foxtrot
Committee(s) Assignment:	Committee on Transportation and Public Way

ORDINANCE
FOXTROT
Acct. No. 392906 - 12
Permit No. 1144426

Be It Ordained by the City Council of the City of Chicago:

SECTION 1. Permission and authority are hereby given and granted to FOXTROT, upon the terms and subject to the conditions of this ordinance to maintain and use two (2) sign(s) projecting over the public right-of-way attached to its premises known as 545 N. McClurg Ct..

Said sign structure(s) measures as follows; along N. McClurg:

One (1) at two (2) feet in length, two point six seven (2.67) feet in height and eleven (11) feet above grade level.

Said sign structure(s) measures as follows; along E. Grand:

One (1) at two (2) feet in length, two point six seven (2.67) feet in height and eleven (11) feet above grade level.

The location of said privilege shall be as shown on prints kept on file with the Department of Business Affairs and Consumer Protection and the Office of the City Clerk.

Said privilege shall be constructed in accordance with plans and specifications approved by the Department of Transportation (Division of Project Development) and Zoning Department - Signs.

This grant of privilege in the public way shall be subject to the provisions of Section 10-28-015 and all other required provisions of the Municipal Code of Chicago.

The grantee shall pay to the City of Chicago as compensation for the privilege #1144426 herein granted the sum of one hundred seventy-five (\$175.00) per annum in advance.

A 25% penalty will be added for payments received after due date.

The permit holder agrees to hold the City of Chicago harmless for any damage, relocation or replacement costs associated with damage, relocation or removal of private property caused by the City performing work in the public way.

Authority herein given and granted for a period of five (5) years from and after Date of Passage.

Alderman

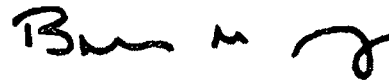

Brendan Reilly 42nd Ward

545 McClurg Ct.

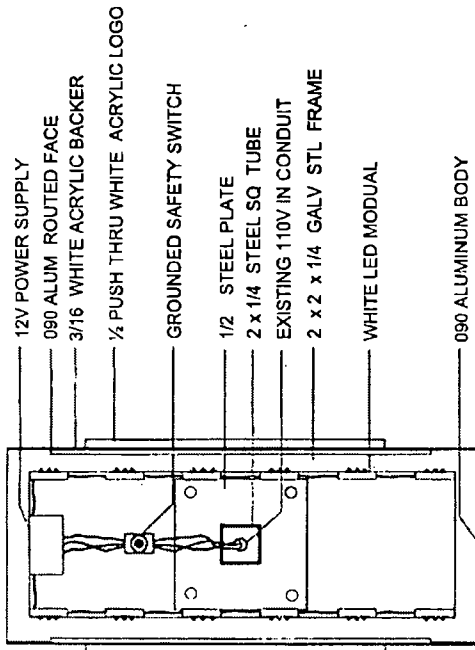
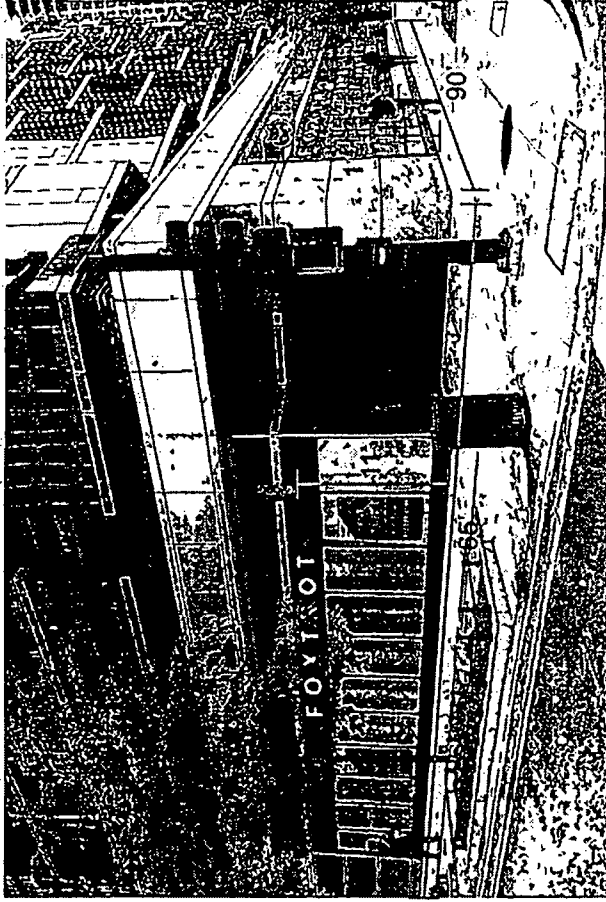

Side View

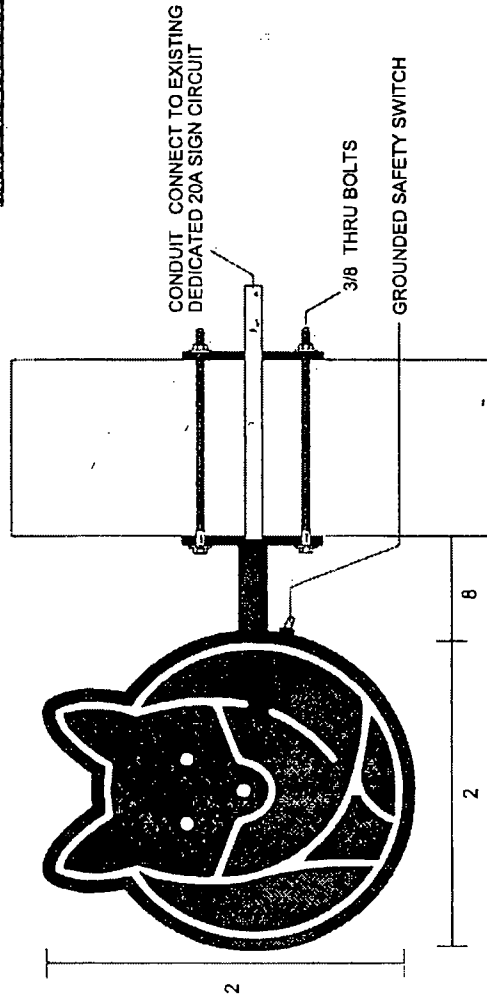

Typical UL Double Face Projecting Box Sign
Not to scale



EXAMPLE

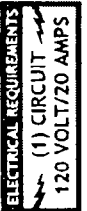
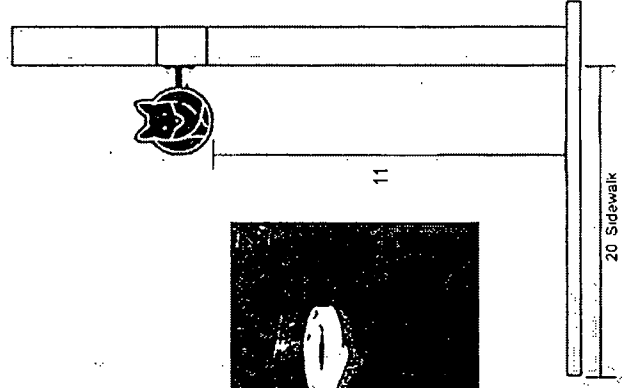



Department of Business Affairs and Consumer Protection
Small Business Center - Public Way Use Unit
City Hall - 121 N. LaSalle Street, Room 800 • Chicago, IL 60602
312-74-GOBIZ / 312-744-6249 • (312) 744-1944 (TTY)
<http://www.cityofchicago.org/bacp>

05/20/2020

Alderman **Brendan Reilly**
Ward # 42
City of Chicago
City Hall, Room 300
121 North LaSalle Street
Chicago, Illinois 60602

Re: An ordinance to use and maintain a portion of the public right-of-way for **two (2) sign(s)** for **FOXTROT**, adjacent to the premises known as **545 N. McClurg Ct.**

Dear Alderman **Brendan Reilly**:

The applicant referenced above has requested the use of the public right-of-way for a **sign(s)**. An ordinance has been prepared by the Department of Business Affairs and Consumer Protection – Small Business Center - Public Way Use Unit for presentation to the City Council. Because this request was made for properties located in your ward, as approved by you as per the attached, I respectfully request that you introduce the attached ordinance at the next City Council meeting.

If you have any questions regarding this ordinance, please contact Anthony Bertuca at (312) 744-5506.

Department of Business Affairs and Consumer Protection

GRANT OF PRIVILEGE APPLICATION PACKAGE

APPLICATION FOR A GRANT OF PRIVILEGE IN THE PUBLIC WAY

APPLICANT INFORMATION

LEGAL NAME OF BUSINESS ENTITY	Foxtrot Ventures Inc		
PERMIT MAILING ADDRESS	440 N Wells St Suite 220		
CITY	Chicago	STATE	IL
		ZIP	60654
CONTACT PERSON	Jason DaPisa	TITLE	VP Construction
PHONE	847 769 3835	FAX	
		E MAIL	jason@foxtrotco.com

DATE OF PERSONAL DELIVERY OF APPLICATION TO ALDERMANIC WARD OFFICE IF APPLICABLE
(Entered by Applicant) 2/6/20

DATE OF MAILING OF APPLICATION TO ALDERMANIC WARD OFFICE IF APPLICABLE
(Entered by Applicant)

USE OF THE PUBLIC WAY

- List the proposed or existing use(s) below and complete the worksheet on page 10
- Use only one application for all public way use types

TYPE	HOW MANY?	BUILDING ADDRESS
Sign	2	545 McClurg Ct Chicago IL 60611

- Please enclose one sketch of proposed use of the public way which maps to scale the proposed use and its relationship to surrounding right of way. All measurements must be indicated.
- The enclosed sketch should also accurately depict the location of the property line and Public facilities (meters, light poles, sidewalks).
- All Applications for permits involving No Fee items must be accompanied by a \$50 application fee. Please remit with Application.
- No Fee items are listed in the price list on page 11.

PROPERTY OWNER INFORMATION

NAME	545 Investors LLC		
ADDRESS	125 High Street High Street Tower 27th floor		
CITY	Boston	STATE	MA
		ZIP	02110

APPLICANT CERTIFICATION

I hereby certify that all statements made as part of this Application and the attachments thereto are true to the best of my knowledge and belief

BY  TITLE Jason DaPisa VP Construction

ALDERMAN'S RECOMMENDATION

Please note: The Alderman's recommendation shall be based on the applicable factors identified in Section 10-28-015(c) of the Municipal Code of Chicago. Aldermanic recommendation for approval shall not be unreasonably withheld or withheld because of the language, content or message contained in or implied by a sign, canopy, awning, banner, marquee or other item for which a permit is sought.

DATE OF RECEIPT OF APPLICATION AT ALDERMANIC WARD OFFICE
(Entered by Alderman or Alderman's designee at the Ward Office)

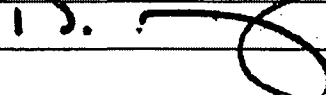
ALDERMAN'S SIGNATURE  DATE 2-11-2020 WARD 12

<input checked="" type="checkbox"/> Recommend in Favor	Provide Reason(s)
<input type="checkbox"/> Recommend Against	

For Aldermanic Ward Office information please go to the City of Chicago Office of the City Clerk website at <http://chicago.legistar.com/People.aspx>

FEB 06 2020