



City of Chicago



SO2017-3807

Office of the City Clerk

Document Tracking Sheet

Meeting Date: 5/24/2017

Sponsor(s): Misc. Transmittal

Type: Ordinance

Title: Zoning Reclassification Map No. 1-G at 1-27 N Ashland Ave,
1548-1554 W Madison St and 1527-1583 W Warren Blvd -
App No. 19221

Committee(s) Assignment: Committee on Zoning, Landmarks and Building Standards

ORDINANCE

BE IT ORDAINED BY THE CITY COUNCIL OF THE CITY OF CHICAGO:

SECTION 1. Title 17 of the Municipal Code of Chicago, the Chicago Zoning Ordinance, is hereby amended by changing all of the C2-3 Motor Vehicle-Related District and B2-3 Neighborhood Mixed-Use District symbols and indications as shown on Map No. 1-G in the area bounded by

West Warren Boulevard; a line 91 feet east of the east line of North Ashland Avenue; the public alley next south of West Warren Boulevard; a line 83 feet east of the east line of North Ashland Avenue; West Madison Street; North Ashland Avenue

to those of a B2-3 Neighborhood Mixed-Use District.

SECTION 2. Title 17 of the Municipal Code of Chicago, the Chicago Zoning Ordinance, is hereby amended by changing all of the B2-3 Neighborhood Mixed-Use District symbols and indications as shown on Map No. 1-G in the area bounded by

West Warren Boulevard; a line 91 feet east of the east line of North Ashland Avenue; the public alley next south of West Warren Boulevard; a line 83 feet east of the east line of North Ashland Avenue; West Madison Street; North Ashland Avenue

to those of Planned Development Number _____, which is hereby established in the area described above and subject to such use and bulk regulations set forth in the Plan of Development attached hereto and to no others.

SECTION 3. This ordinance shall be in force and effect from and after its passage and due publication.

Common Street Address: 1-27 N. Ashland Avenue; 1548 - 1554 W. Madison;
1527-1583 W. Warren Boulevard

Planned Development _____

Plan of Development Statements

1. The area delineated herein as Planned Development Number _____, ("Planned Development") consists of approximately 21,197 square feet (.486 acres) of Net Site Area which is depicted on the attached Planned Development Boundary and Property Line Map ("Property") and is owned or controlled by the City of Chicago. The City of Chicago has given consent to the Applicant, Heartland Housing, Inc., an Illinois not-for-profit corporation, to file this application.
2. The requirements, obligations and conditions contained within this Planned Development shall be binding upon the Applicant, its successors and assigns and, if different than the Applicant, the legal title holders and any ground lessors. All rights granted hereunder to the Applicant shall inure to the benefit of the Applicant's successors and assigns and, if different than the Applicant, the legal title holder and any ground lessors. Furthermore, pursuant to the requirements of Section 17-8-0400 of the Chicago Zoning Ordinance, the Property, at the time of application for amendments, modifications or changes (administrative, legislative or otherwise) to this Planned Development are made, shall be under single ownership or designated control. Single designated control is defined in Section 17-8-0400 of the Zoning Ordinance.
3. All applicable official reviews, approvals or permits are required to be obtained by the Applicant or its successors, assignees or grantees. Any dedication or vacation of streets or alleys or grants of easements or any adjustment of the right-of-way shall require a separate submittal to the Department of Transportation on behalf of the Applicant or its successors, assign or grantees.

Any requests for grants of privilege, or any items encroaching on the public way, shall be in compliance with the Planned Development.

Ingress or egress shall be pursuant to the Plans and may be subject to the review and approval of the Departments of Planning and Development and Transportation. Closure of all or any public street or alley during demolition or construction shall be subject to the review and approval of the Department of Transportation.

Pursuant to a negotiated and executed Perimeter Restoration Agreement ("Agreement") by and between the Department of Transportation's Division of Infrastructure Management and the Applicant, the Applicant shall provide improvements and restoration of all public way adjacent to the property, which may include, but not be limited to, the following as shall be reviewed and determined by the Department of Transportation's Division of Infrastructure Management:

- Full width of streets
- Full width of alleys
- Curb and gutter
- Pavement markings
- Sidewalks
- ADA crosswalk ramps
- Parkway & landscaping

The Perimeter Restoration Agreement must be executed prior to any Department of Transportation and Planned Development Part II review permitting. The Agreement shall reflect that all work must comply with current Rules and Regulations and must be designed and constructed in accordance with the Department of Transportation's Construction Standards for work in the Public Way and in compliance with the Municipal Code of Chicago Chapter 10-20. Design of said improvements should follow the Department of Transportation's Rules and Regulations for Construction in the Public Way as well as The Street and Site Plan Design Guidelines. Any variation in scope or design of public way improvements and restoration must be approved by the Department of Transportation.

4. This Plan of Development consists of seventeen (17) Statements: a Bulk Regulations Table; an Existing Aerial Site Image; an Existing Zoning and Street Map System; an Existing Land-Use Area map; a Planned Development Boundary and Property Line Map; a Generalized Site Plan; a Landscape/Roof Plan; Overall Site Elevations including: North Building North Elevation; North Building West Elevation; North Building South Elevation; North Building East Elevation; South Building Elevations; North Building Axon Details, and South Building Axon Details prepared by Valerio Dewalt Train Associates dated June 21, 2018 submitted herein. In any instance where a provision of this Planned Development conflicts with the Chicago Building Code, the Building Code shall control. This Planned Development conforms to the intent and purpose of the Zoning Ordinance, and all requirements thereto, and satisfies the established criteria for approval as a Planned Development. In case of a conflict between the terms of this Planned Development Ordinance and the Zoning Ordinance, this Planned Development Ordinance shall control.
5. The following uses are permitted in the area delineated herein as a Planned Development: Dwelling Units located above and on the ground floor; Office (not to exceed 3000 square feet); Wireless Communication Facilities (Co-located); Accessory Parking and Accessory Uses.
6. On-Premise signs and temporary signs, such as construction and marketing signs, shall be permitted within the Planned Development, subject to the review and approval of the Department of Planning and Development. Off-Premise signs are prohibited within the boundary of the Planned Development.

Applicant Heartland Housing, Inc

Address 1-27 N Ashland Avenue, 1548 - 1554 W Madison, 1527-1583 W Warren Boulevard

Introduced May 24, 2017

Plan Commission June 21, 2018

7. For purposes of height measurement, the definitions in the Zoning Ordinance shall apply. The height of any building shall also be subject to height limitations, if any, established by the Federal Aviation Administration.
8. The maximum permitted Floor Area Ratio ("FAR") for the site shall be in accordance with the attached Bulk Regulations Table. For the purposes of FAR calculations and measurements, the definitions in the Zoning Ordinance shall apply. The permitted FAR identified in the Bulk Regulations Table has been determined using a Net Site Area of 21,197 square feet and a base FAR of 3.3.
9. Upon review and determination, "Part II Review", pursuant to Section 17-13-0610 of the Zoning Ordinance, a Part II Review Fee shall be assessed by the Department of Planning and Development. The fee, as determined by staff at the time, is final and binding on the Applicant and must be paid to the Department of Revenue prior to the issuance of any Part II approval.
10. The Site and Landscape Plans shall be in substantial conformance with the Landscape Ordinance and any other corresponding regulations and guidelines, including Section 17-13-0800. Final landscape plan review and approval will be by the Department of Planning and Development. Any interim reviews associated with site plan review or Part II reviews, are conditional until final Part II approval.
11. The Applicant shall comply with Rules and Regulations for the Maintenance of Stockpiles promulgated by the Commissioners of the Departments of Streets and Sanitation, Environment and Buildings, under Section 13-32-085, or any other provision of the Municipal Code of Chicago.
12. The terms and conditions of development under this Planned Development ordinance may be modified administratively, pursuant to section 17-13-0611-A of the Zoning Ordinance by the Zoning Administrator upon the application for such a modification by the Applicant, its successors and assigns and, if different than the Applicant, the legal title holders and any ground lessors.
13. The Applicant acknowledges that it is in the public interest to design, construct and maintain the project in a manner which promotes, enables and maximizes universal access throughout the Property. Plans for all buildings and improvements on the Property shall be reviewed and approved by the Mayor's Office for People with Disabilities to ensure compliance with all applicable laws and regulations related to access for persons with disabilities and to promote the highest standard of accessibility.
14. The Applicant acknowledges that it is in the public interest to design, construct, renovate and maintain all buildings in a manner that provides healthier indoor environments, reduces operating costs and conserves energy and natural resources. The Applicant shall obtain the number of points necessary to meet the requirements of the Chicago Sustainable

Development Policy, in effect at the time the Part II review process is initiated for each improvement that is subject to the aforementioned Policy and must provide documentation verifying compliance.

15. The Applicant acknowledges that it is the policy of the City to maximize opportunities for Minority and Women-owned Business Enterprises (“M/WBEs”) and city residents to compete for contracts and jobs on construction projects approved through the planned development process. To assist the city in promoting and tracking such M/WBE and city resident participation, an applicant for planned development approval shall provide information at three points in the city approval process. First, the applicant must submit to DPD, as part of its application for planned development approval, an M/WBE Participation Proposal. The M/WBE Participation Proposal must identify the applicant’s goals for participation of certified M/WBE firms in the design, engineering and construction of the project, and of city residents in the construction work. The city encourages goals of 26% MBE and 6% WBE participation (measured against the total construction budget for the project or any phase thereof), and (ii) 50% city resident hiring (measured against the total construction work hours for the project or any phase thereof). The M/WBE Participation Proposal must include a description of the Applicant’s proposed outreach plan designed to inform M/WBEs and city residents of job and contracting opportunities. Second, at the time of the Applicant’s submission for Part II permit review for the project or any phase thereof, the Applicant must submit to DPD (a) updates (if any) to the Applicant’s preliminary outreach plan, (b) a description of the Applicant’s outreach efforts and evidence of such outreach, including, without limitation, copies of certified letters to M/WBE contractor associations and the ward office of the alderman in which the project is located and receipts thereof; (c) responses to the Applicant’s outreach efforts, and (d) updates (if any) to the applicant’s M/WBE and city resident participation goals. Third, prior to issuance of a Certificate of Occupancy for the project or any phase thereof, the Applicant must provide DPD with the actual level of M/WBE and city resident participation in the project or any phase thereof, and evidence of such participation. In addition to the forgoing, DPD may request such additional information as the department determines may be necessary or useful in evaluating the extent to which M/WBEs and city residents are informed of and utilized in planned development projects. All such information will be provided in a form acceptable to the Zoning Administrator. DPD will report the data it collects regarding projected and actual employment of M/WBEs and city residents in planned development projects twice yearly to the Chicago Plan Commission and annually to the Chicago City Council and the Mayor.

16. The Applicant acknowledges and agrees that the rezoning of the Property from C2-3 Motor Vehicle-Related District and B2-3 Neighborhood Mixed-Use District to B2-3 Neighborhood Mixed-Use District, and then to this Planned Development for construction of the Project triggers the requirements of Section 2-45-115 of the Municipal Code (the “Affordable Requirements Ordinance” or the “ARO”). The Applicant further acknowledges and agrees that the Property is located in the Near North/Near West Pilot Area, pursuant to Section 2-45-117 of the Municipal Code (the “Near North/Near West ARO Pilot Area Ordinance” or the “Pilot”). The Near North/Near West Pilot Area is divided into two zones: the Near North

Zone and the Near West Zone. The Property is located in the Near North Zone. In the Near North Zone, pursuant to the ARO, the percentage of units in a residential housing project required to be affordable for a period of 30 years, whether rental or for-sale, is increased from 10% to 20%. Any developer of a residential housing project in the Near North Zone must provide the first 10% of units required to be affordable (the "First Units") either: (i) in the residential housing project, or (ii) with the approval of the Commissioner of the Department of Planning and Development (the "Commissioner"), in an off-site location within two miles of the Property and in the same or a different higher income area or downtown district, or (iii) any combination of (i) and (ii). In addition, the developer must provide the second 10% of units required to be affordable (the "Additional Units") either: (i) in the residential housing project, or (ii) with the Commissioner's approval, in an off-site location anywhere within the Near North/Near West Pilot Area, regardless of distance from the project or income area, or (iii) any combination of (i) and (ii). The project has a total of 75 housing units. As a result, the Applicant's affordable housing obligation is 15 affordable units (20% of 75, rounded up), consisting of 8 First Units and 7 Additional Units. Applicant has agreed to satisfy its affordable housing obligation by providing all 15 Units in the rental building to be constructed in the Planned Development. In accordance with the ARO Pilot, the Applicant is required to lease the First Units to households earning up to 60% of the Chicago Primary Metropolitan Statistical Area median income ("AMI") at prices affordable to households at such income level, and the Additional Units to households earning up to 80% or 100% of AMI, as determined by rule and approved by the Commissioner at prices affordable to households at such income level. If the Applicant subsequently reduces (or increases) the number of housing units in the project, or elects to build a for-sale project instead of a rental project, or (with the Commissioner's approval) elects to construct off-site units instead of on-site units, the Applicant shall update and resubmit the Affordable Housing Profile Form to the Department of Planning and Development ("DPD") for review and approval. DPD may adjust the requirements to reflect any such change without amending the Planned Development. Prior to the issuance of any building permits for any residential building in the Planned Development, including, without limitation, excavation or foundation permits, the Applicant must execute and record an affordable housing agreement in accordance with Section 2-45-115(L). The terms of the affordable housing agreement and any amendments thereto are incorporated herein by this reference. The Applicant acknowledges and agrees that the affordable housing agreement will be recorded against the Planned Development, or the applicable portion thereof, and will constitute a lien against such property. The Commissioner may enforce remedies for any breach of this Statement 16, including any breach of any affordable housing agreement, and enter into settlement agreements with respect to any such breach, subject to the approval of the Corporation Counsel, without amending the Planned Development.

Notwithstanding the foregoing, if the Applicant receives Low-Income Housing Tax Credits, tax increment financing or other financial assistance whose affordability requirements exceed those of the Affordable Housing Ordinance from the City to develop affordable housing in any portion of the PD, the regulatory, redevelopment, loan or other agreement(s) to be executed by the City and the Applicant in connection with such tax credits or other financial

Applicant Heartland Housing, Inc

Address 1-27 N Ashland Avenue, 1548 - 1554 W Madison, 1527-1583 W Warren Boulevard

Introduced May 24, 2017

Plan Commission June 21, 2018

assistance shall govern and control the Applicant's obligation to provide affordable housing for such subsidized portion of the PD.

17. This Planned Development shall be governed by Section 17-13-0612 of the Zoning Ordinance. Should this Planned Development ordinance lapse, the Commissioner of the Department of Planning and Development shall initiate a Zoning Map Amendment to rezone the property to B2-3 Neighborhood Mixed-Use District.

194591.8

**PLANNED DEVELOPMENT NUMBER _____
BULK REGULATIONS AND DATA TABLE**

Gross Site Area:	52,006 square feet (1.19 acres)
Area Remaining in Public Right of Way	30,809 square feet (.71 acres)
Net Site Area:	21,197 square feet (.48 acres)
Maximum Number of Dwelling Units:	75 Units*
Maximum Floor Area Ratio:	3.3
Minimum Number of Off-Street Parking Spaces:	19 Spaces
Minimum Number of Bicycle Parking Spaces:	26 Spaces
Off-Street Loading Spaces:	1 (10' x 25')
Minimum Required Setbacks:	As Per Site Plan
Maximum Building Height:	77' 6"

*Including six efficiency units

194901.4

FINAL FOR PUBLICATION

PLANNED DEVELOPMENT SITE



VALERIO DEWALT TRAIN

APPLICANT: HEARTLAND ALLIANCE, INC.
ADDRESS: 1533 W. WARREN BLVD;
3 N. ASHLAND AVE;
CHICAGO, IL 60612

DATE: JUNE 21, 2018

EXISTING AERIAL SITE
IMAGERY



01

PORTION OF SITE ZONED AS B2-3

PORTION OF SITE ZONED AS C2-3

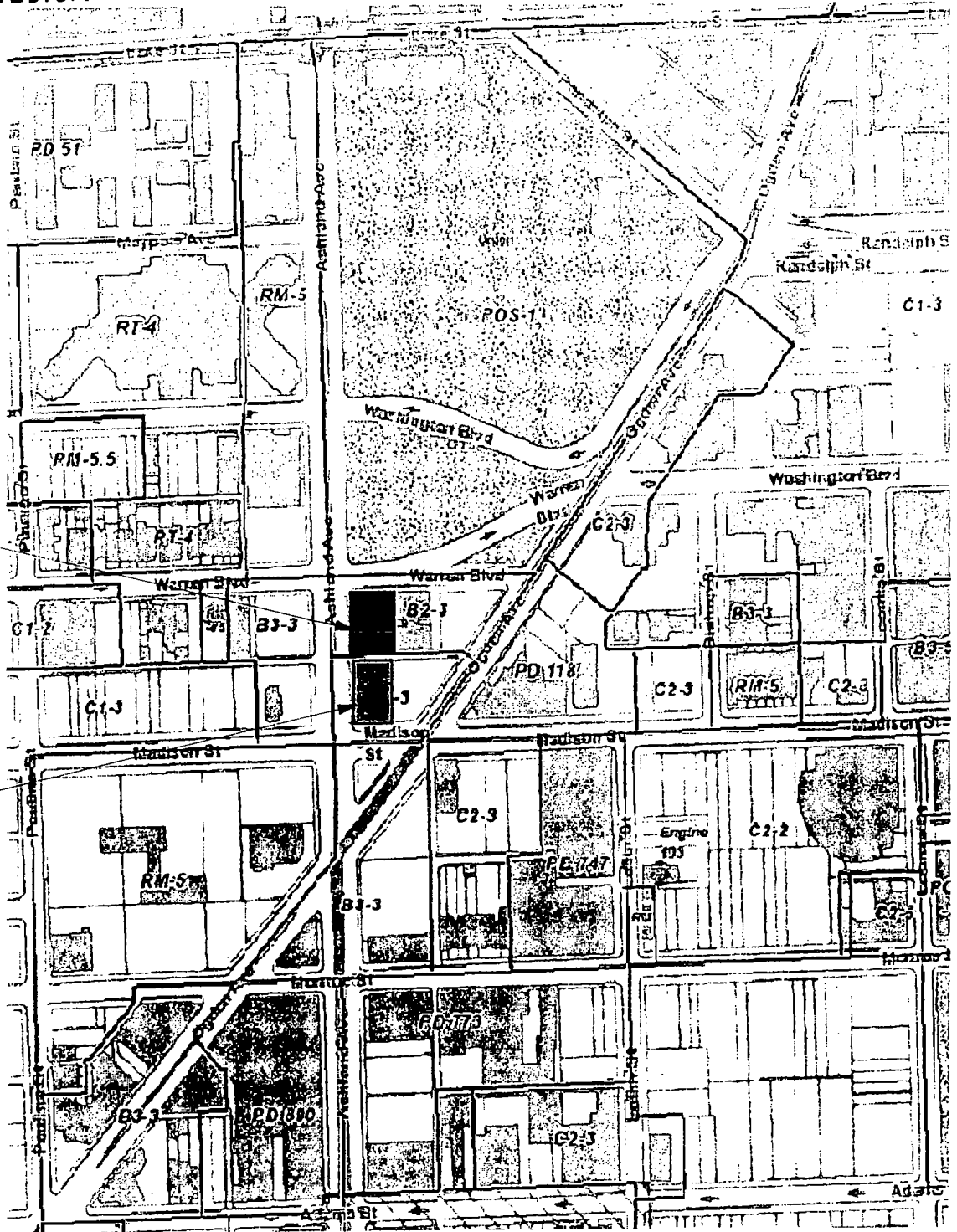

VALERIO DEWALT TRAIN

APPLICANT: HEARTLAND ALLIANCE, INC.
 ADDRESS: 1533 W. WARREN BLVD;
 3 N. ASHLAND AVE;
 CHICAGO, IL 60612
 DATE: JUNE 21, 2018

EXISTING ZONING AND STREET MAP SYSTEM

02

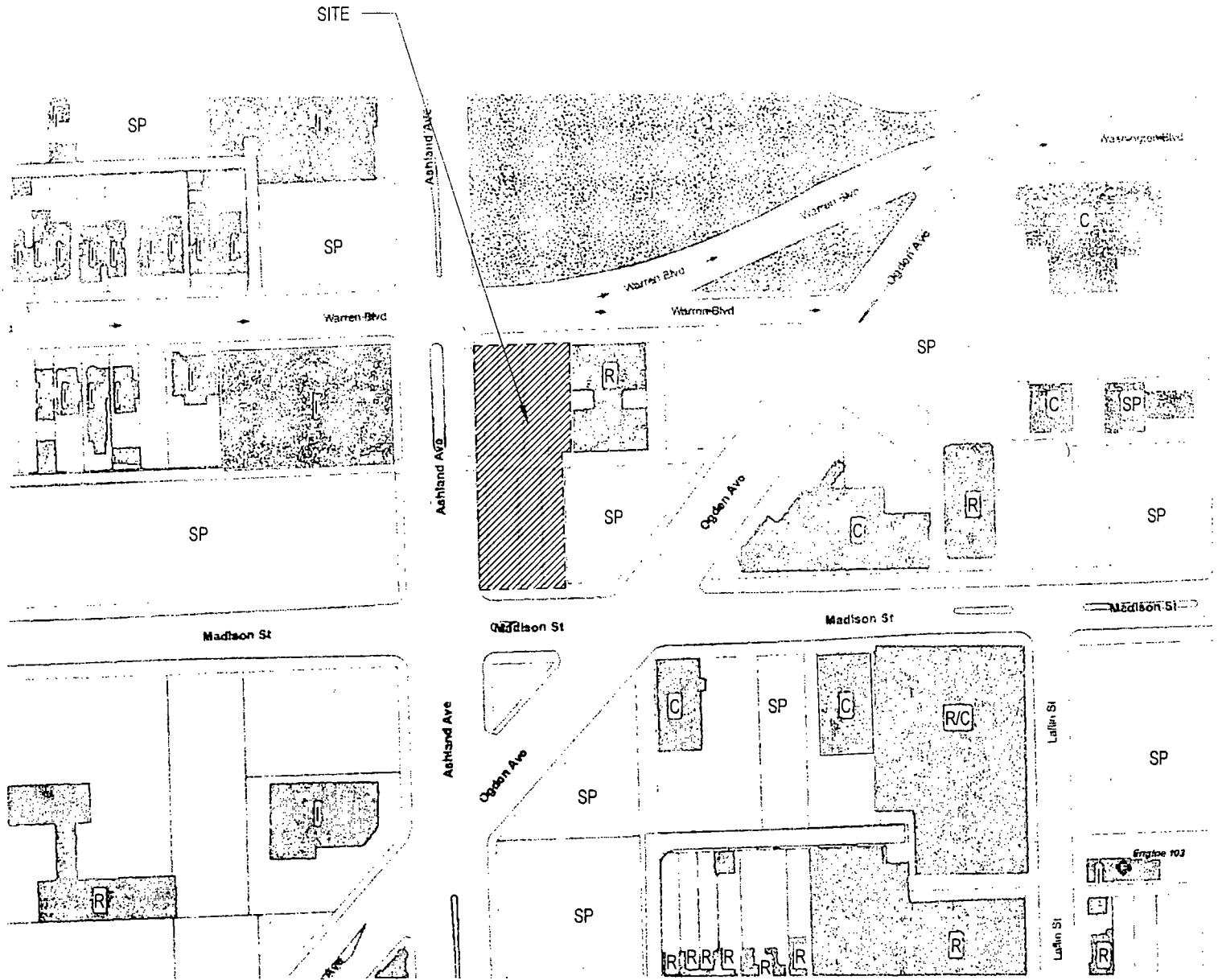

USE KEY:

- R = RESIDENTIAL
- C = COMMERCIAL / OFFICE
- I = INSTITUTIONAL
- SP = SURFACE PARKING



**VALERIO
DEWALT
TRAIN**

APPLICANT: HEARTLAND ALLIANCE, INC.
 ADDRESS: 1533 W. WARREN BLVD;
 3 N. ASHLAND AVE;
 CHICAGO, IL 60612
 DATE: JUNE 21, 2018

**EXISTING LAND-USE
AREA MAP**

03

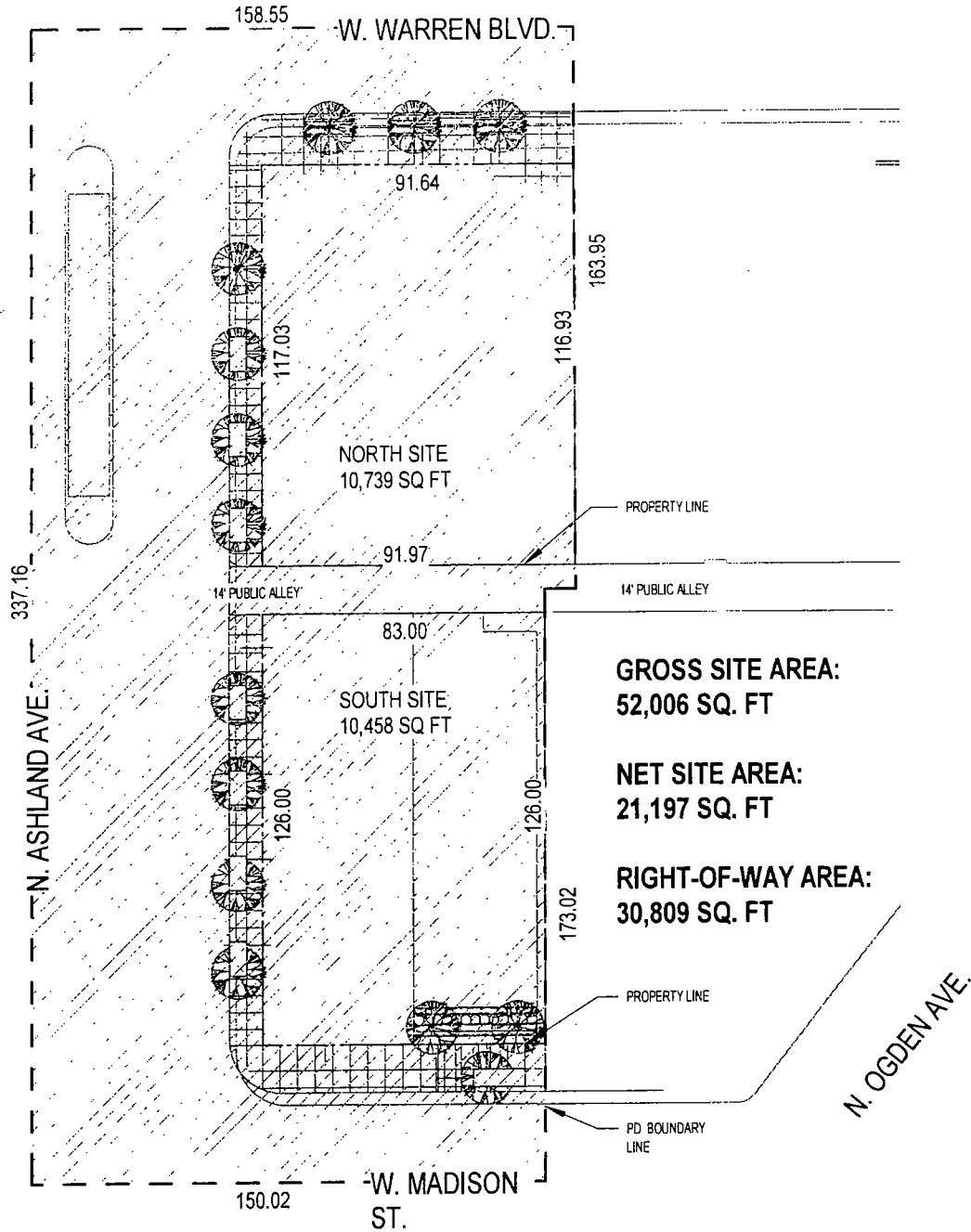

**GROSS SITE AREA:
52,006 SQ. FT**

**NET SITE AREA:
21,197 SQ. FT**

**RIGHT-OF-WAY AREA:
30,809 SQ. FT**

**VALERIO
DEWALT
TRAIN**

APPLICANT: HEARTLAND ALLIANCE, INC.
 ADDRESS: 1533 W. WARREN BLVD;
 3 N. ASHLAND AVE;
 CHICAGO, IL 60612
 DATE: JUNE 21, 2018

**PLANNED
DEVELOPMENT
BOUNDARY AND
PROPERTY LINE MAP**



04

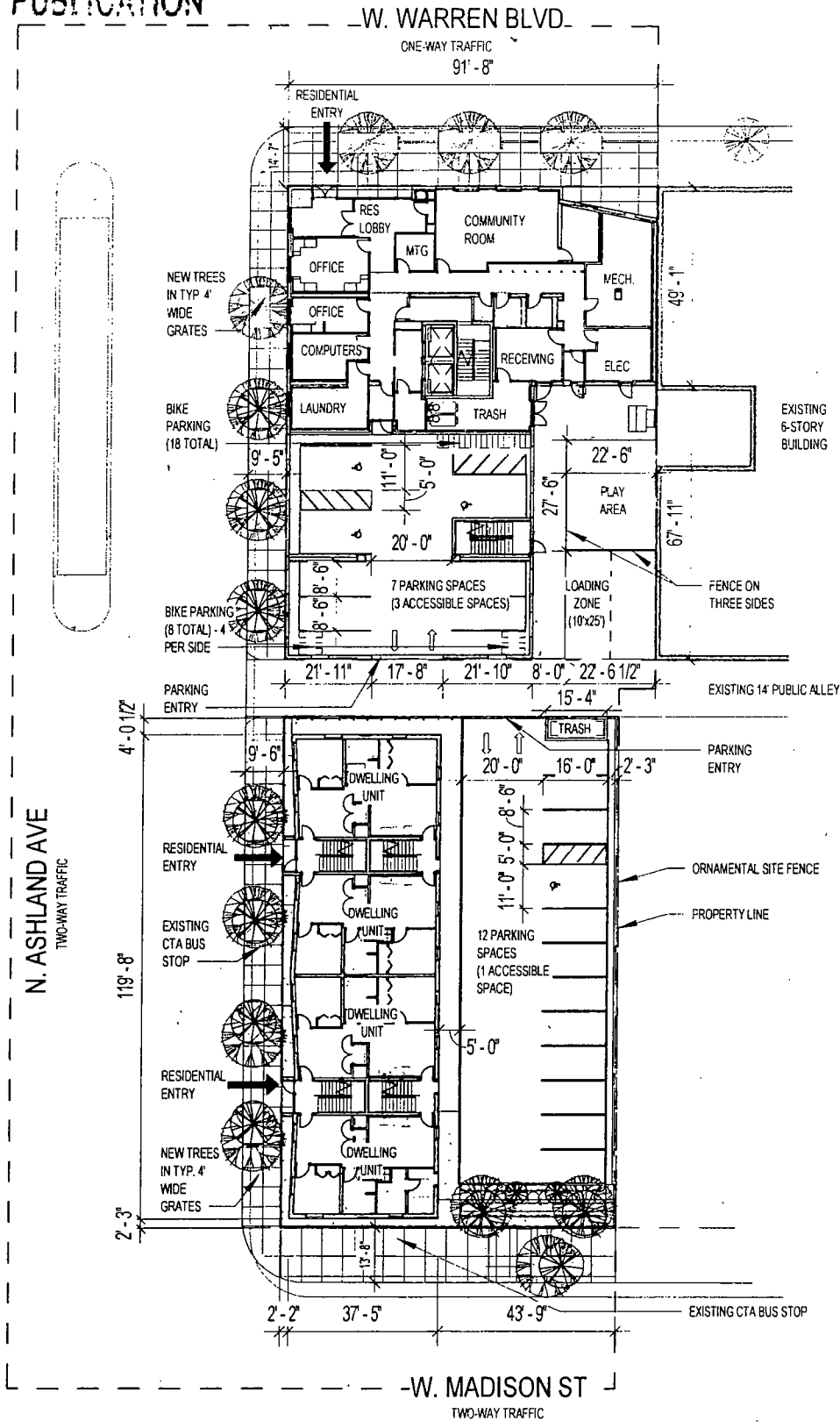

**VALERIO
DEWALT
TRAIN**

APPLICANT: HEARTLAND ALLIANCE, INC.
 ADDRESS: 1533 W. WARREN BLVD;
 3 N. ASHLAND AVE;
 CHICAGO, IL 60612
 DATE: JUNE 21, 2017

**GENERALIZED SITE
PLAN**

05

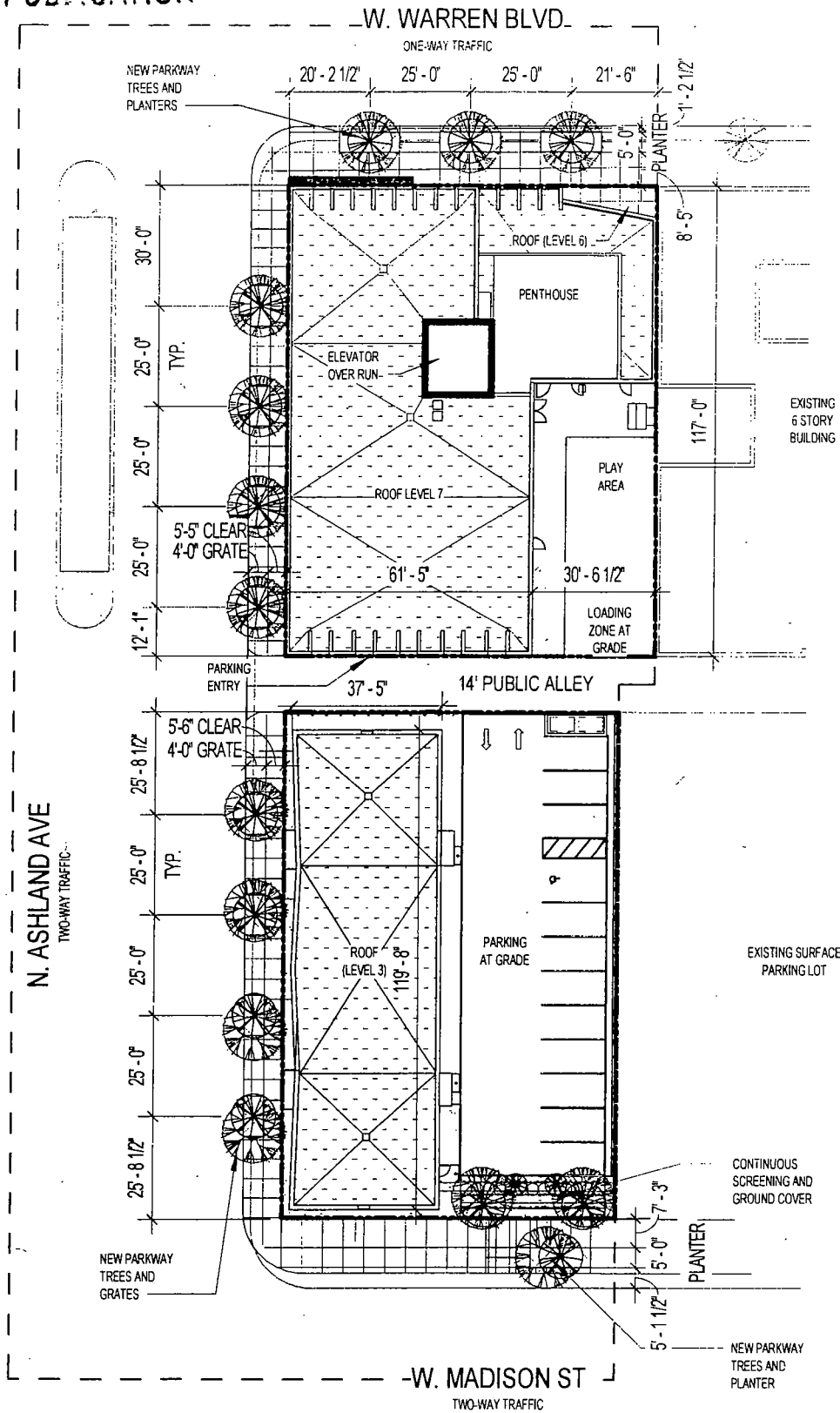

**VALERIO
DEWALT
TRAIN**

APPLICANT: HEARTLAND ALLIANCE, INC.
 ADDRESS: 1533 W. WARREN BLVD;
 3 N. ASHLAND AVE;
 CHICAGO, IL 60612
 DATE: JUNE 21, 2018

**LANDSCAPE PLAN /
ROOF PLAN**



06

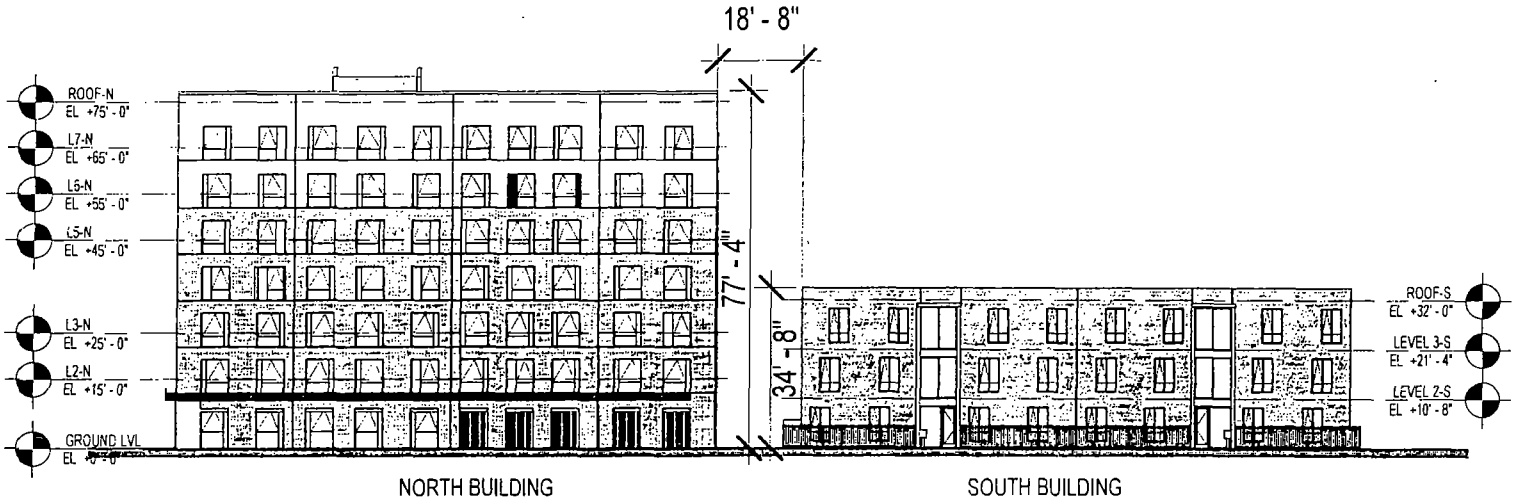

1 WEST ELEVATION

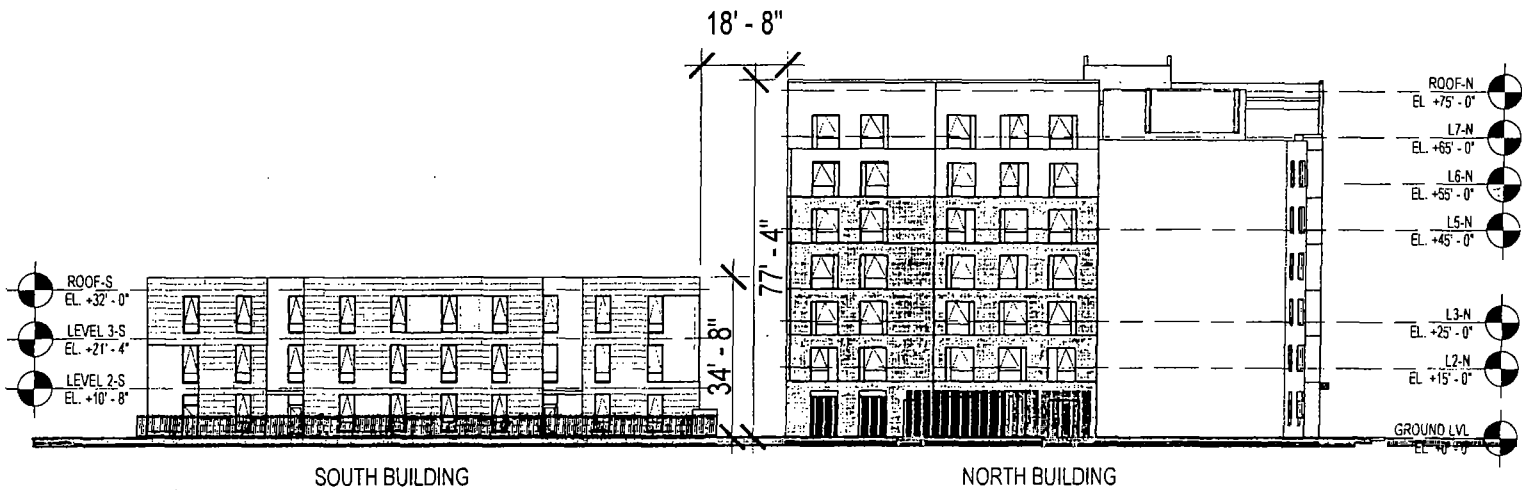

2 EAST ELEVATION

**VALERIO
DEWALT
TRAIN**

APPLICANT: HEARTLAND ALLIANCE, INC.
 ADDRESS: 1533 W. WARREN BLVD;
 3 N. ASHLAND AVE;
 CHICAGO, IL 60612

DATE: JUNE 21, 2018

**OVERALL SITE
ELEVATIONS**

07

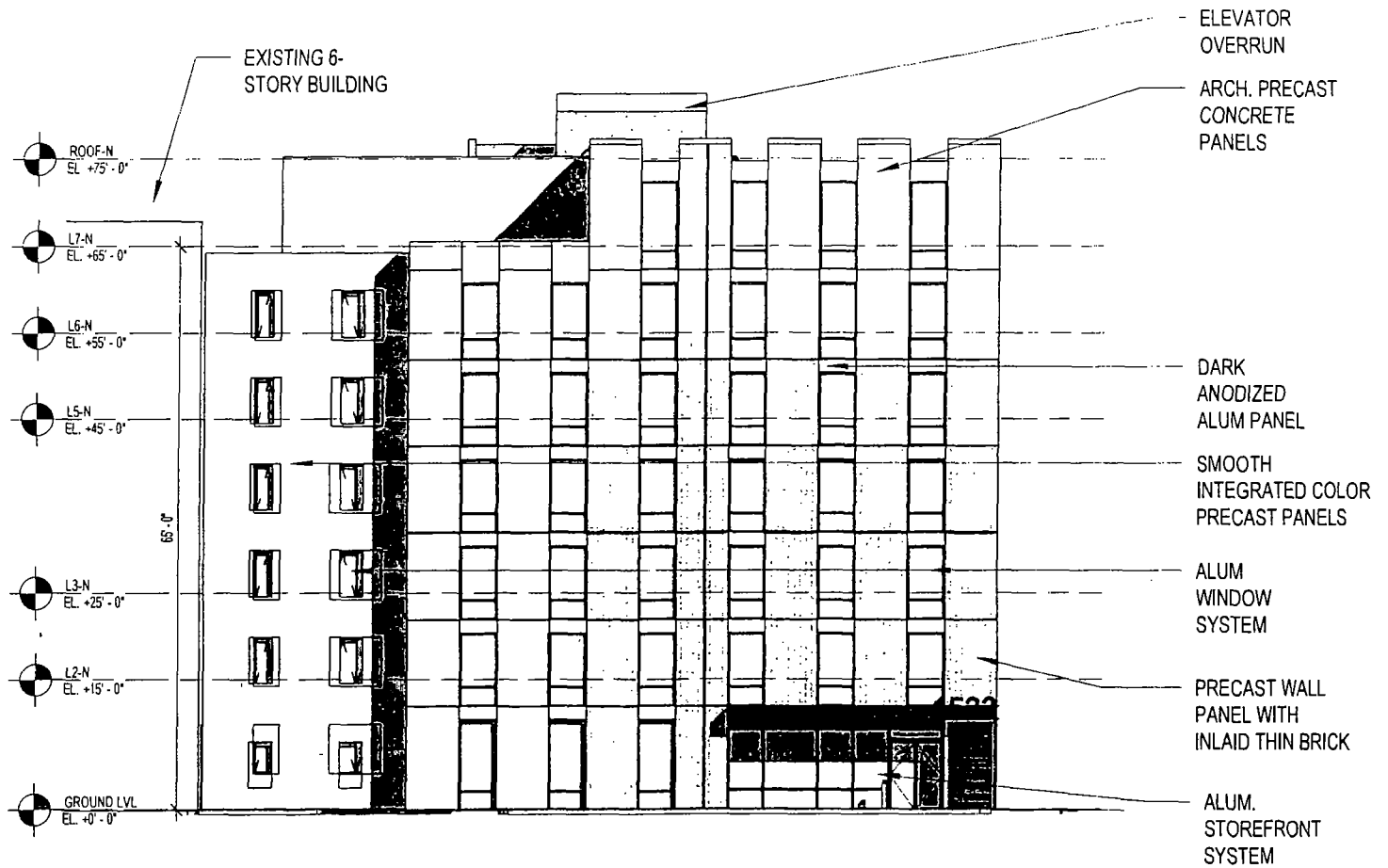

1 NORTH BUILDING - NORTH ELEVATION

**VALERIO
DEWALT
TRAIN**

APPLICANT: HEARTLAND ALLIANCE, INC.
 ADDRESS: 1533 W. WARREN BLVD;
 3 N. ASHLAND AVE;
 CHICAGO, IL 60612
 DATE: JUNE 21, 2018

**NORTH BUILDING
 NORTH ELEVATION**

08

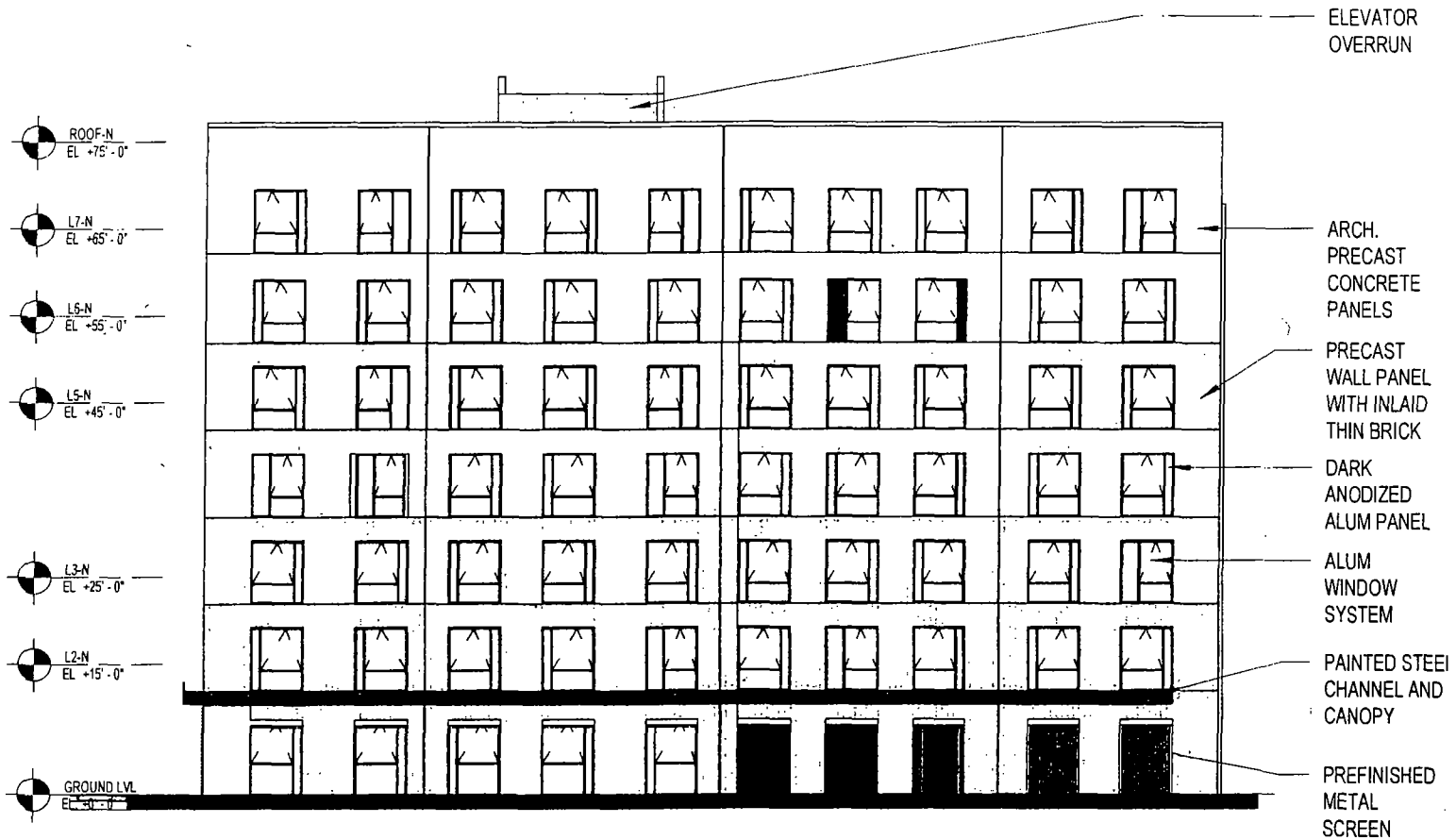

1 NORTH BUILDING - WEST ELEVATION

**VALERIO
DEWALT
TRAIN**

APPLICANT:	HEARTLAND ALLIANCE, INC.	NORTH BUILDING WEST ELEVATION
ADDRESS:	1533 W. WARREN BLVD; 3 N. ASHLAND AVE; CHICAGO, IL 60612	
DATE:	JUNE 21, 2018	



1 NORTH BUILDING - SOUTH ELEVATION

**VALERIO
DEWALT
TRAIN**

APPLICANT: HEARTLAND ALLIANCE, INC.
 ADDRESS: 1533 W. WARREN BLVD;
 3 N. ASHLAND AVE;
 CHICAGO, IL 60612
 DATE: MAY 24, 2017

**NORTH BUILDING
SOUTH ELEVATION**

APPROX OUTLINE OF EXISTING
ADJACENT BUILDING

ARCH.
PRECAST
CONCRETE
PANELS

DARK
ANODIZED
ALUM PANEL

ALUM
WINDOW
SYSTEM

PRECAST
WALL PANEL
WITH INLAID
THIN BRICK

PREFINISHED
METAL
SCREEN

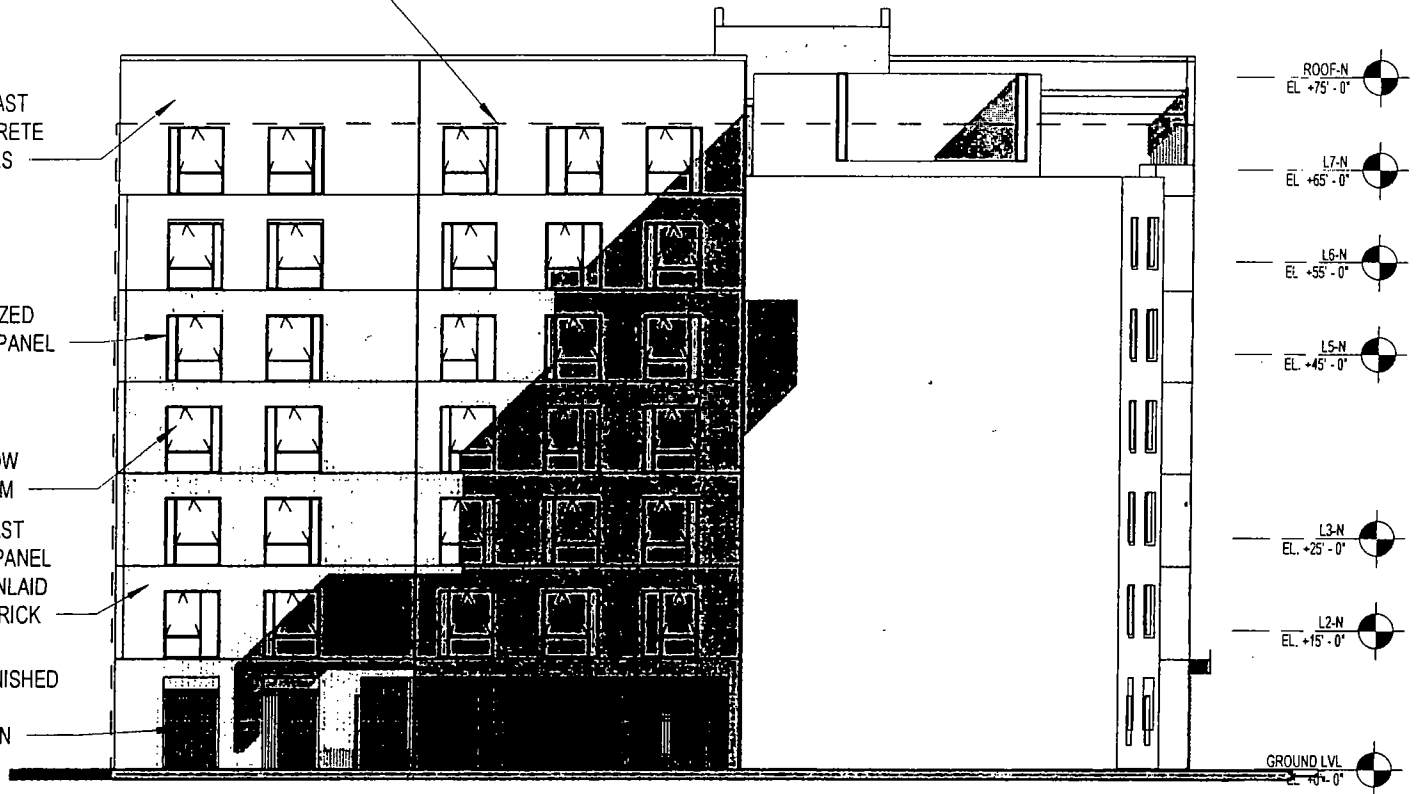

1 NORTH BUILDING - EAST ELEVATION

**VALERIO
DEWALT
TRAIN**

APPLICANT: HEARTLAND ALLIANCE, INC.
ADDRESS: 1533 W. WARREN BLVD;
3 N. ASHLAND AVE;
CHICAGO, IL 60612

DATE: JUNE 21, 2018

**NORTH BUILDING EAST
ELEVATION**

11

TOP

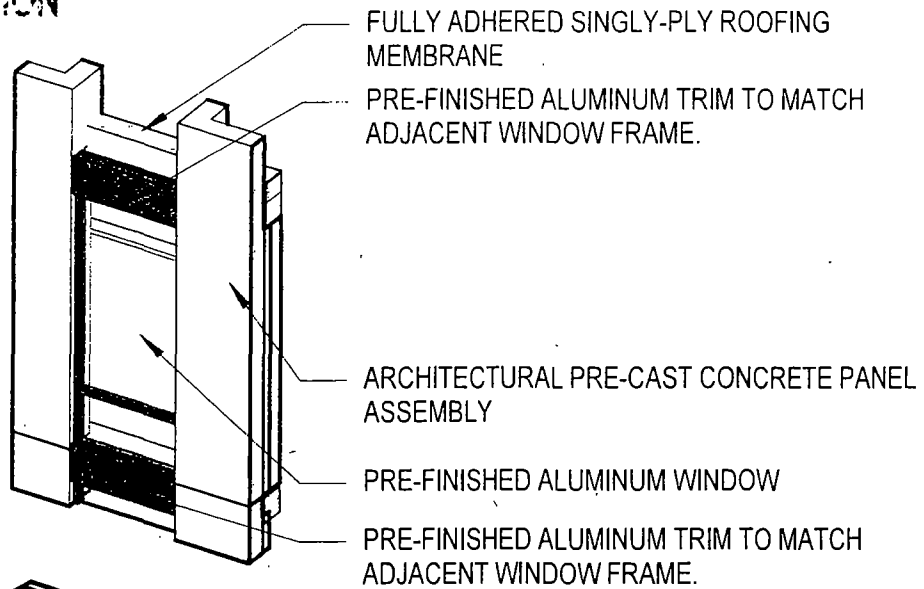

MIDDLE

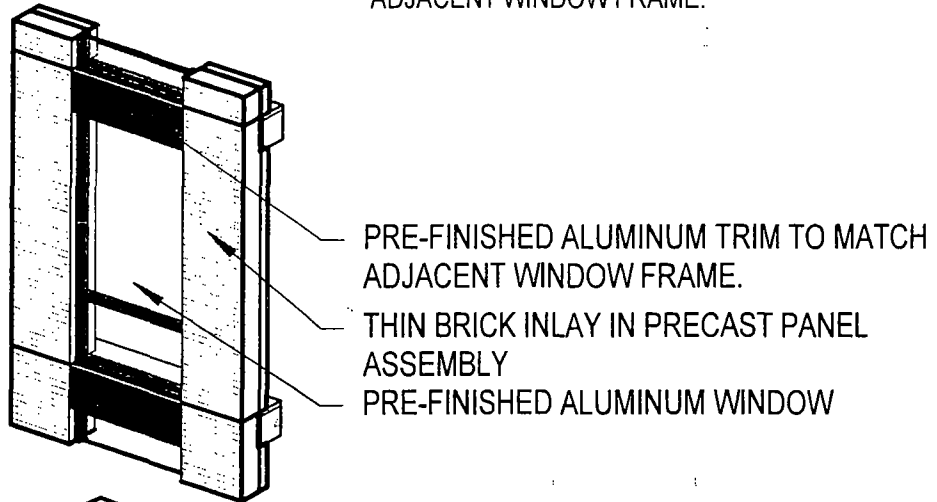

BOTTOM

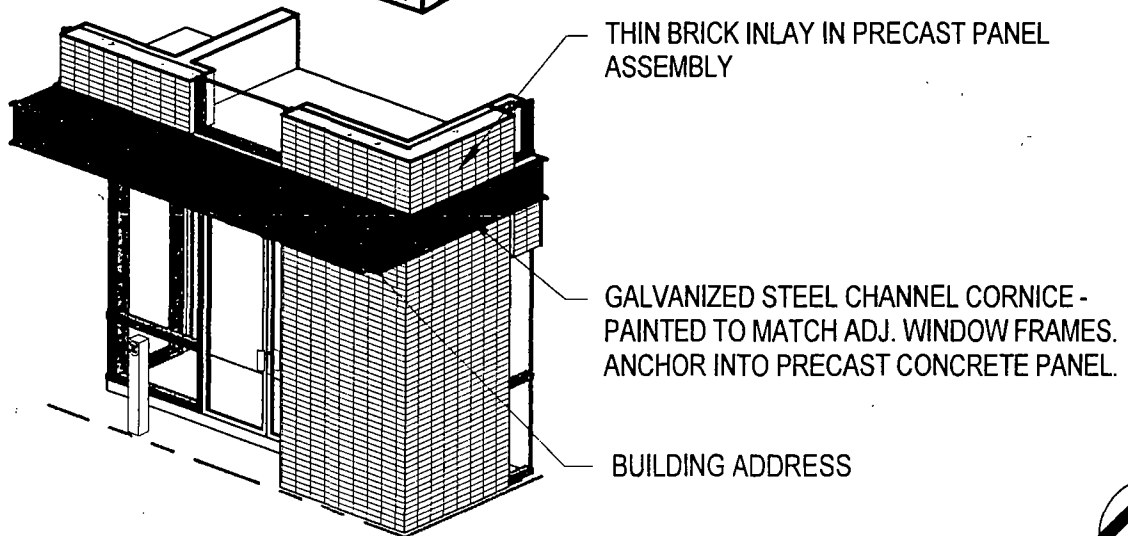

**VALERIO
DEWALT
TRAIN**

APPLICANT: HEARTLAND ALLIANCE, INC.
 ADDRESS: 1533 W. WARREN BLVD;
 3 N. ASHLAND AVE;
 CHICAGO, IL 60612
 DATE: 06/20/18

**NORTH BUILDING AXON
DETAILS**

12

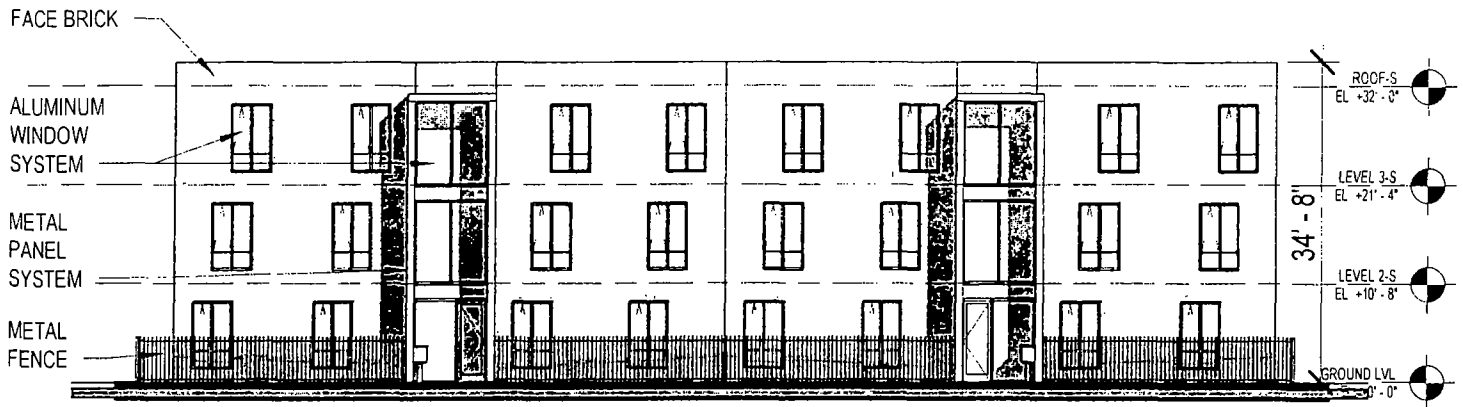

1 SOUTH BUILDING - WEST ELEVATION

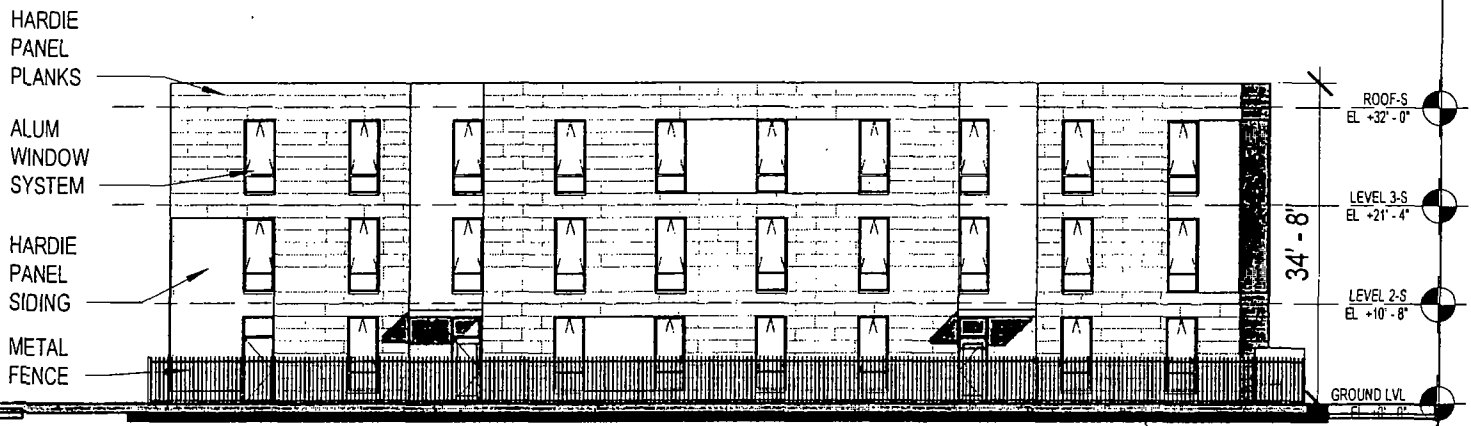

2 SOUTH BUILDING - EAST ELEVATION

**VALERIO
DEWALT
TRAIN**

APPLICANT: HEARTLAND ALLIANCE, INC.
 ADDRESS: 1533 W. WARREN BLVD;
 3 N. ASHLAND AVE;
 CHICAGO, IL 60612
 DATE: JUNE 21, 2018

**SOUTH BUILDING
ELEVATIONS**

13

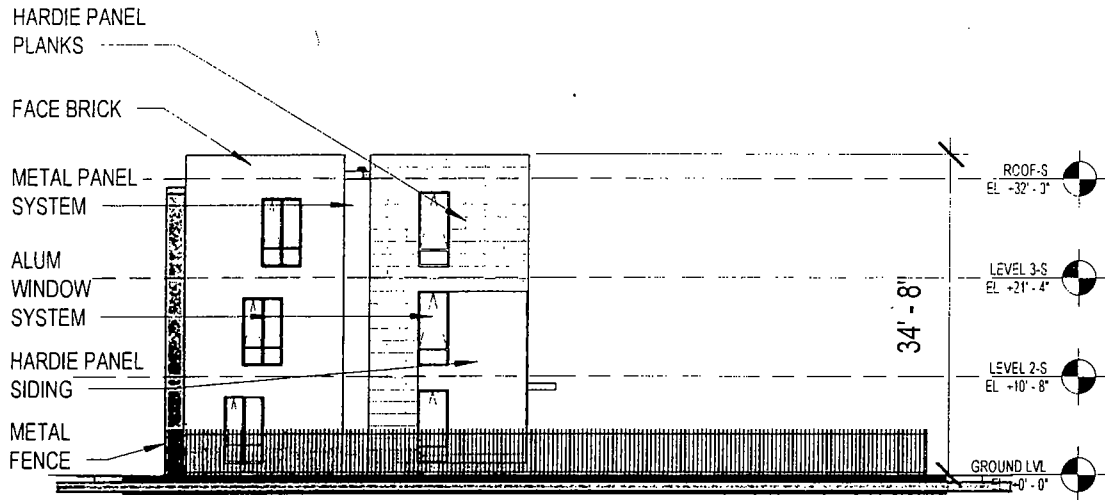

① SOUTH BUILDING - SOUTH ELEVATION

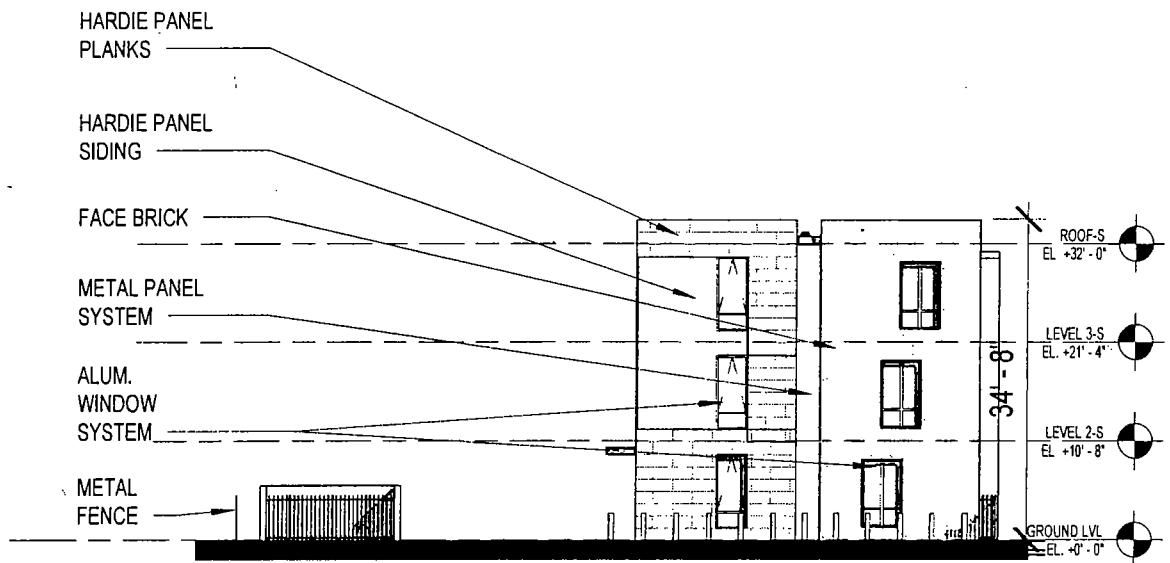

② SOUTH BUILDING - NORTH ELEVATION

**VALERIO
DEWALT
TRAIN**

APPLICANT: HEARTLAND ALLIANCE, INC.
 ADDRESS: 1533 W. WARREN BLVD;
 3 N. ASHLAND AVE;
 CHICAGO, IL 60612
 DATE: JUNE 21, 2018

**SOUTH BUILDING
ELEVATIONS**

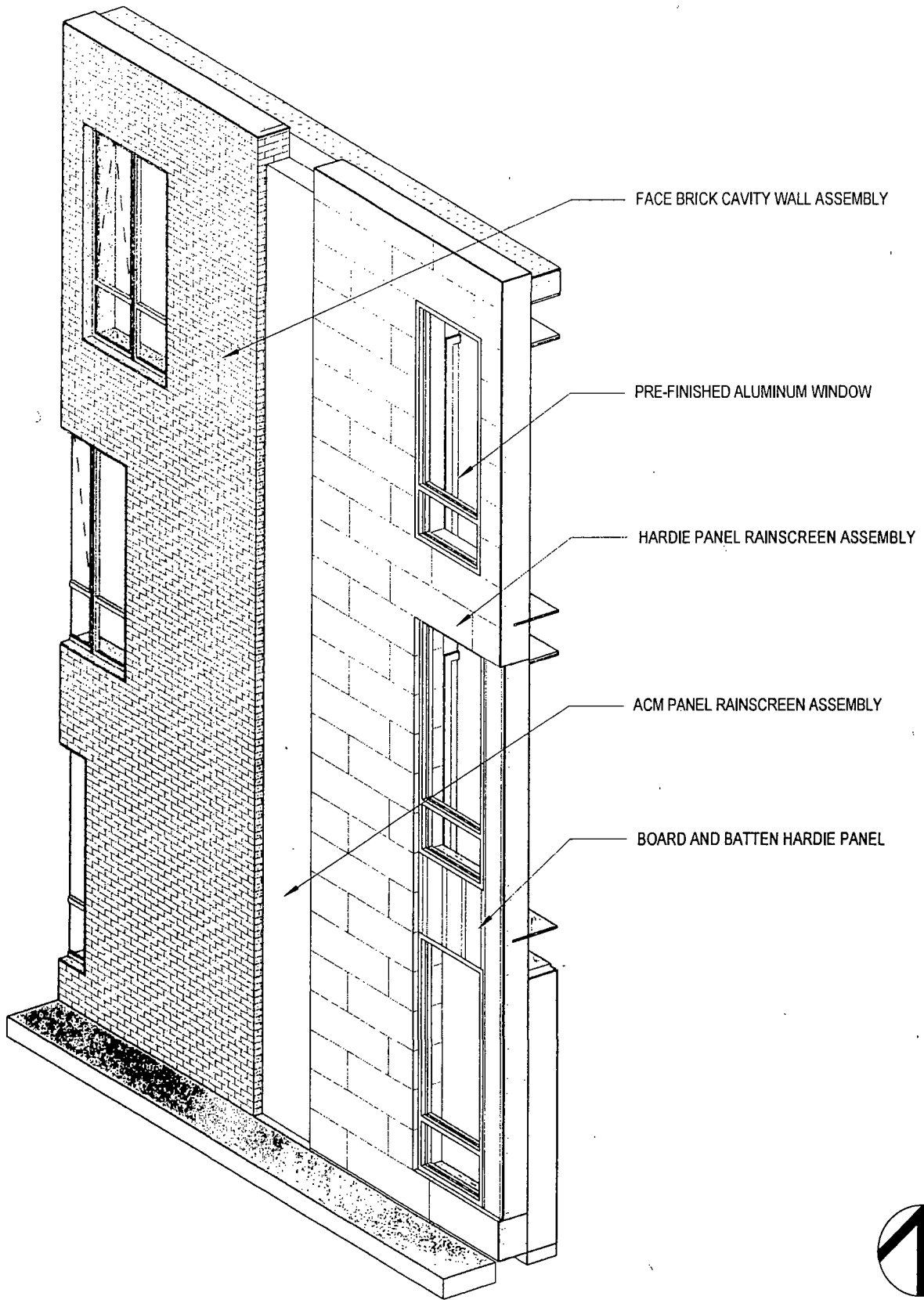

**VALERIO
DEWALT
TRAIN**

APPLICANT: HEARTLAND ALLIANCE, INC.
 ADDRESS: 1533 W. WARREN BLVD;
 3 N. ASHLAND AVE;
 CHICAGO, IL 60612
 DATE: 06/20/18

**SOUTH BUILDING AXON
DETAILS**



DEPARTMENT OF PLANNING AND DEVELOPMENT
CITY OF CHICAGO

MEMORANDUM

To: Alderman Daniel S. Solis
Chairman, City Council Committee on Zoning

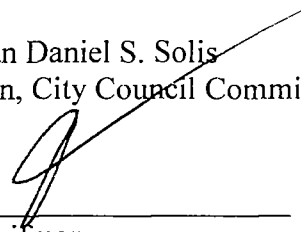
From: 
David Reifman
Commissioner
Department of Planning and Development

Date: June 21, 2018

Re: Proposed Planned Development (1-27 North Ashland Ave., 1548-54 West Madison, and 1527-83 West Warren Blvd.)

On June 21, 2018, the Chicago Plan Commission recommended approval of a proposed Planned Development amendment submitted by the Applicant, Heartland Housing, Inc. The project involves the construction of a 77'4" tall, seven-story building with 63 residential units and 7 automobile parking spaces and a 34'8" tall, three-story building with 12 residential units and 12 automobile parking spaces. A copy of the proposed ordinance, planned development statements, bulk table and exhibits are attached. I would very much appreciate your assistance in having this introduced at the next possible City Council Committee on Zoning.

Also enclosed is a copy of the staff report to the Plan Commission which includes the Department of Planning and Development, Bureau of Zoning and Land Use recommendation and a copy of the resolution. If you have any questions in this regard, please do not hesitate to contact me at 744-0756.

Cc: PD Master File (Original PD, copy of memo)

FINAL TO CLERK

19221