



City of Chicago



O2017-3796

Office of the City Clerk

Document Tracking Sheet

Meeting Date:	5/24/2017
Sponsor(s):	Misc. Transmittal
Type:	Ordinance
Title:	Zoning Reclassification Map No. 1-G at 1001 W Fulton Market - App No. 19211
Committee(s) Assignment:	Committee on Zoning, Landmarks and Building Standards

19211

INTRO. DATE:

MAY 24, 2017

ORDINANCE

BE IT ORDAINED BY THE CITY COUNCIL OF THE CITY OF CHICAGO:

SECTION 1. Title 17 of the Municipal Code of Chicago, the Chicago Zoning Ordinance, is hereby amended by changing all of the C1-1 Neighborhood Commercial District symbols and indications as shown on Map No. 1-G in the area bounded by

West Fulton Market; North Morgan Street; a line 100.52 feet south of the south line of West Fulton Market; and a line 31.52 feet west of the west line of North Morgan Street

to those of a DX-3 Downtown Mixed-Use District.

SECTION 2. That the Chicago Zoning Ordinance be amended by changing all of the DX-3 Downtown Mixed-Use District and the indications as shown on Map 1-G in the area bounded by:

West Fulton Market; North Morgan Street; a line 100.52 feet south of the south line of West Fulton Market; and a line 31.52 feet west of the west line of North Morgan Street

to those of a Business Planned Development, which is hereby established in the area above described, subject to such use and bulk regulations as are set forth in the Plan of Development herewith attached and made a part thereof and to no others.

SECTION 3. This ordinance shall be in force and effect from and after its passage and due publication.

Common Address: 1001 West Fulton Market

BUSINESS PLANNED DEVELOPMENT NO. _____

PLANNED DEVELOPMENT STATEMENTS

1. The area delineated herein as Business Planned Development No. _____ (the “Planned Development”) consists of a net site area of approximately 3,168 square feet of property which is depicted on the attached Planned Development Boundary and Property Line Map (the “Property”). The Property is owned by Vequity LLC Series XIII Fulton, an Illinois limited liability company (the “Applicant”).
2. The requirements, obligations and conditions contained within this Planned Development shall be binding upon the Applicant, its successors and assigns. All rights granted hereunder to the Applicant shall inure to the benefit of the Applicant, its successors and assigns. Furthermore, pursuant to the requirements of Section 17-8-0400 of the Chicago Zoning Ordinance, at the time applications for amendments, modifications or changes (administrative, legislative or otherwise) to this Planned Development are made, the Property shall be under single ownership or under single designated control. Single designated control for purposes of this Statement shall mean that any application to the City for any amendment to this Planned Development or any other modification or change thereto (administrative, legislative or otherwise) shall be made or authorized by all the owners of the Property and any ground lessees of the Property. Nothing herein shall prohibit or in any way restrict the alienation, sale or any other transfer of all or any portion of the Property or any rights, interests or obligations therein. Upon any alienation, sale or any other transfer of all or any portion of the Property or the rights therein (other than an assignment or transfer of rights pursuant to a mortgage or otherwise as collateral for any indebtedness) and solely with respect to the portion of the Property so transferred, the term “Applicant”, “ground lessee” or “titleholder” shall be deemed amended to apply to the transferee thereof (and its beneficiaries if such transferee is a land trust) and the seller or transferor thereof (and its beneficiaries if such seller or transferor is a land trust) shall thereafter be released from any and all obligations or liability hereunder with respect to the portion of the Property so transferred.
3. All applicable official reviews, approvals or permits are required to be obtained by any owner of the Property, as applicable, or its successors, assigns or grantees, which require such reviews, approvals or permits. Any dedication or vacation of streets or alleys or grants of easements or any adjustment of the right-of-way shall require a separate submittal to the Department of Transportation on behalf of the applicable Property owner, its successors, assigns or grantees, seeking such action.

Any requests for grants of privilege, or any items encroaching on the public way, shall be in compliance with the Plans, as defined below.

Ingress or egress shall be pursuant to the Plans (as defined below) and may be subject to the review and approval of the Departments of Planning and Development and Transportation. Closure of all or any public street or alley during demolition or construction shall be subject to the review and approval of the Department of Transportation.

Applicant: Vequity LLC Series XIII Fulton
Address: 1001 West Fulton Market
Introduced: May 24, 2017
Plan Commission: _____, 2017

All work proposed in the public way must be designed and constructed in accordance with the Department of Transportation Construction Standards for Work in the Public Way and in compliance with the Municipal Code of the City of Chicago. Prior to the issuance of any Part II approval, the submitted plans must be approved by the Department of Transportation.

4. This Plan of Development consists of 16 Statements; a Bulk Regulations and Data Table; an Existing Zoning Map; an Existing Land Use Map; a Planned Development Boundary and Property Line Map; a Site Plan; and Elevations (North, South, East and West), all prepared by Ileki Associates and dated _____, 2017 (collectively, the "Plans"). In any instance where a provision of this Planned Development conflicts with the Chicago Building Code, the Building Code shall control. This Planned Development conforms to the intent and purpose of the Zoning Ordinance, and all requirements thereto, and satisfies the established criteria for approval as a Planned Development. In case of a conflict between the terms of this Planned Development Ordinance and the Zoning Ordinance, this Planned Development Ordinance shall control.
5. The following uses are permitted within the area delineated as Business Planned Development: Animal services – sales and grooming and veterinary; eating and drinking establishments; amusement arcades (accessory only to eating and drinking establishments); indoor participant sports and recreation; banks, currency exchange, credit union and ATM facilities (but excluding drive thrus, pay day loan stores and pawn shops; food and beverage retail sales uses; roof top patios; medical service; office; personal service uses; consumer repair or laundry services (except for plant on premises); general retail sales; wireless communications facilities; and incidental and related uses.
6. On-Premise signs and temporary signs, such as construction and marketing signs, shall be permitted within the Planned Development, subject to the review and approval of the Department of Planning and Development. Off-Premise signs are prohibited within the boundary of the Planned Development.
7. For purposes of height measurement, the definitions in the Zoning Ordinance shall apply. The height of any building shall also be subject to height limitations, if any, established by the Federal Aviation Administration.
8. The maximum permitted Floor Area Ratio ("FAR") for the site shall be in accordance with the attached Bulk Regulations Table. For the purposes of FAR calculations and measurements, the definitions in the Zoning Ordinance shall apply. The permitted FAR identified in the Bulk Regulations Table has been determined using a Net Site Area of 3,168.39 square feet.
9. The Applicant acknowledges that the project has received a bonus FAR of 1.3 pursuant to Sec. 17-4-1000 of the Zoning Ordinance. With this bonus FAR, the total FAR for the Planned Development is 4.3. In exchange for the bonus FAR, the Applicant is required to make a corresponding payment, pursuant to Sections 17.4-1003-B & C, prior to the issuance of the first building permit for any building in the Planned Development. The

Applicant:	Vequity LLC Series XIII Fulton
Address:	1001 West Fulton Market
Introduced:	May 24, 2017
Plan Commission	_____, 2017

bonus payment will be recalculated at the time of payment (including partial payments for phased developments) and may be adjusted based on changes in median land values in accordance with Section 17-4-1003-C.3.

The bonus payment will be split between three separate funds, as follow: 80% to the Neighborhoods Opportunity Fund, 10% to the Citywide Adopt-a-Landmark Fund and 10% to the Local Impact Fund. In lieu of paying the City directly, the Department may: (a) direct developers to deposit a portion of the funds with a sister agency to finance specific local improvement projects; (b) direct developers to deposit a portion of the funds with a landmark property owner to finance specific landmark restoration projects; or, (c) approve proposals for in-kind improvements to satisfy the Local Impact portion of the payment.

10. Upon review and determination, "Part II Review", pursuant to Section 17-13-0610 of the Zoning Ordinance, a Part II Review Fee shall be assessed by the Department of Planning and Development. The fee, as determined by staff at the time, is final and binding and must be paid to the Department of Revenue prior to the issuance of any Part II approval.
11. The Site Plans shall be in substantial conformance with the Landscape Ordinance and any other corresponding regulations and guidelines. Final landscape plan review and approval will be by the Department of Planning and Development. Any interim reviews associated with site plan review or Part II reviews, are conditional until final Part II approval.
12. The Applicant shall comply with Rules and Regulations for the Maintenance of Stockpiles promulgated by the Commissioners of the Departments of Streets and Sanitation, Environment and Buildings, under Section 13-32-125 of the Municipal Code, or any other provision of that Code.
13. Subject to the provisions of Statement No. 2 of this Planned Development, the terms and conditions of development under this Planned Development ordinance may be modified administratively pursuant to Section 17-13-0611-A of the Zoning Ordinance by the Zoning Administrator upon the application for such a modification by the Applicant, its successors and assigns and, if different than the Applicant, the legal titleholders and any ground lessors.
14. The Applicant acknowledges that it is in the public interest to design, construct and maintain the project in a manner which promotes, enables and ensures universal access throughout the Property. Plans for all new buildings and improvements on the Property constructed after the date hereof shall be reviewed and approved by the Mayor's Office for People with Disabilities to ensure compliance with all applicable laws and regulations related to access for persons with disabilities.
15. The Applicant acknowledges that it is in the public interest to design, construct, renovate and maintain all buildings in a manner that provides healthier indoor environments, reduces operating costs and conserves energy and natural resources. In furtherance of

Applicant.	Vequity LLC Series XIII Fulton
Address	1001 West Fulton Market
Introduced	May 24, 2017
Plan Commission	_____, 2017

this policy, the Applicant shall comply with the City of Chicago's Sustainable Development Policy in effect as of the date of passage and publication.

16. This Planned Development shall be governed by Section 17-13-0612 of the Zoning Ordinance. Should this Planned Development ordinance lapse due to the passage of time, the Commissioner of the Department of Planning and Development shall initiate a Zoning Map Amendment to rezone this Residential-Business Planned Development to DX-3 Downtown Mixed-Use District.

Applicant: Vequity LLC Series XIII Fulton
Address: 1001 West Fulton Market
Introduced: May 24, 2017
Plan Commission: _____, 2017

INSTITUTIONAL PLANNED DEVELOPMENT NO. ____

BULK REGULATIONS AND DATA TABLE

GROSS SITE AREA: 9,066 sf

AREA IN THE PUBLIC RIGHT OF WAY: 5,898 sf

NET SITE AREA: 3,168 sf

MAXIMUM PERMITTED FAR: 4.3

MAXIMUM NUMBER OF DWELLING UNITS: 0

MINIMUM NUMBER OF OFF STREET PARKING SPACES: 0

MINIMUM NUMBER OF BIKE PARKING SPACES: 2

MINIMUM NUMBER OF OFF STREET LOADING BERTHS: 0

SETBACKS FROM THE PROPERTY LINE: In accordance with the site plan.

MAXIMUM BUILDING HEIGHT: 80 feet

Applicant Vequity LLC Series XIII Fulton
Address 1001 West Fulton Market
Introduced: May 24, 2017
Plan Commission _____, 2017

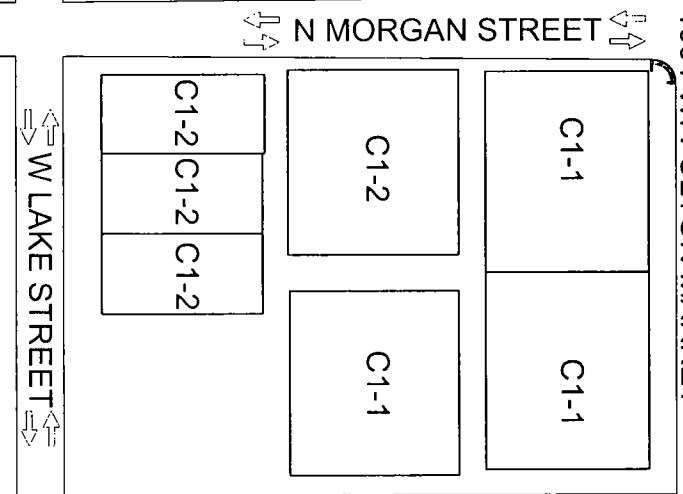
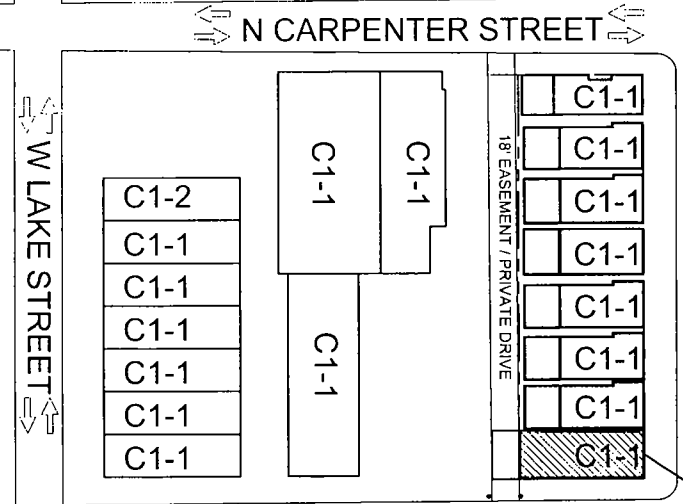
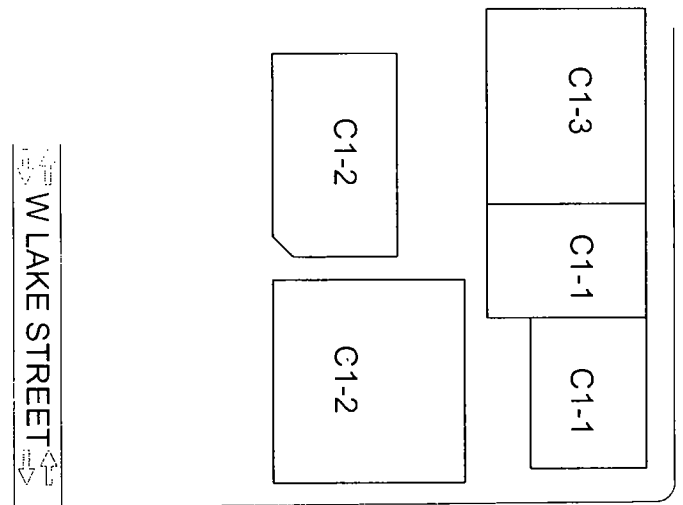
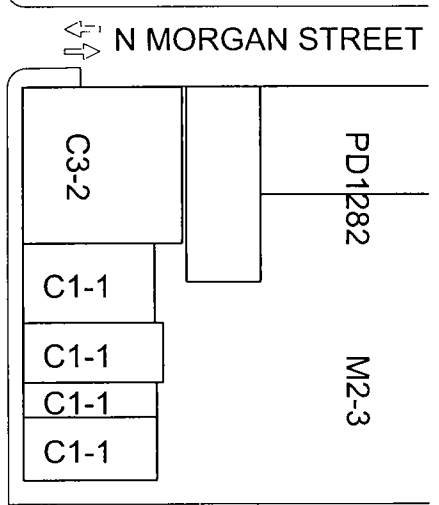
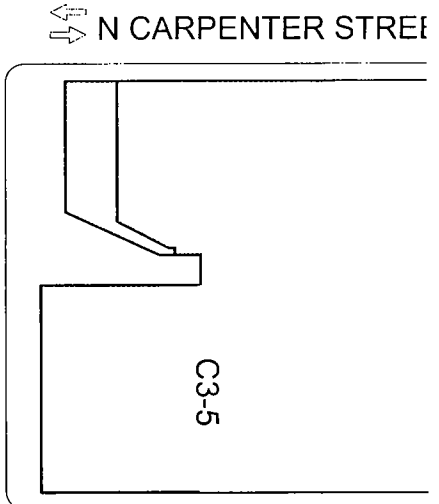
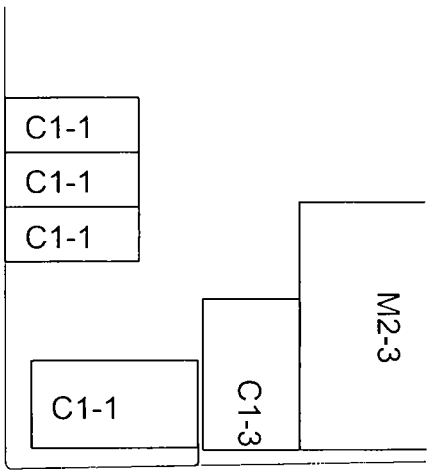

W FULTON MARKET

W FULTON MARKET

W FULTON MARKET
1001 W. FULTON MARKET

W LAKE STREET

W LAKE STREET

W LAKE STREET

N CARPENTER STREET

N MORGAN STREET

N SANGAMON STREET

Applicant: Vequity LLC Series XIII Fulton
 Address: 1001 West Fulton Market
 Chicago, IL
 Introduction: May 24, 2017
 Plan Commission: _____, 2017

EXISTING ZONING MAP
 SCALE: N.T.S.
 NORTH



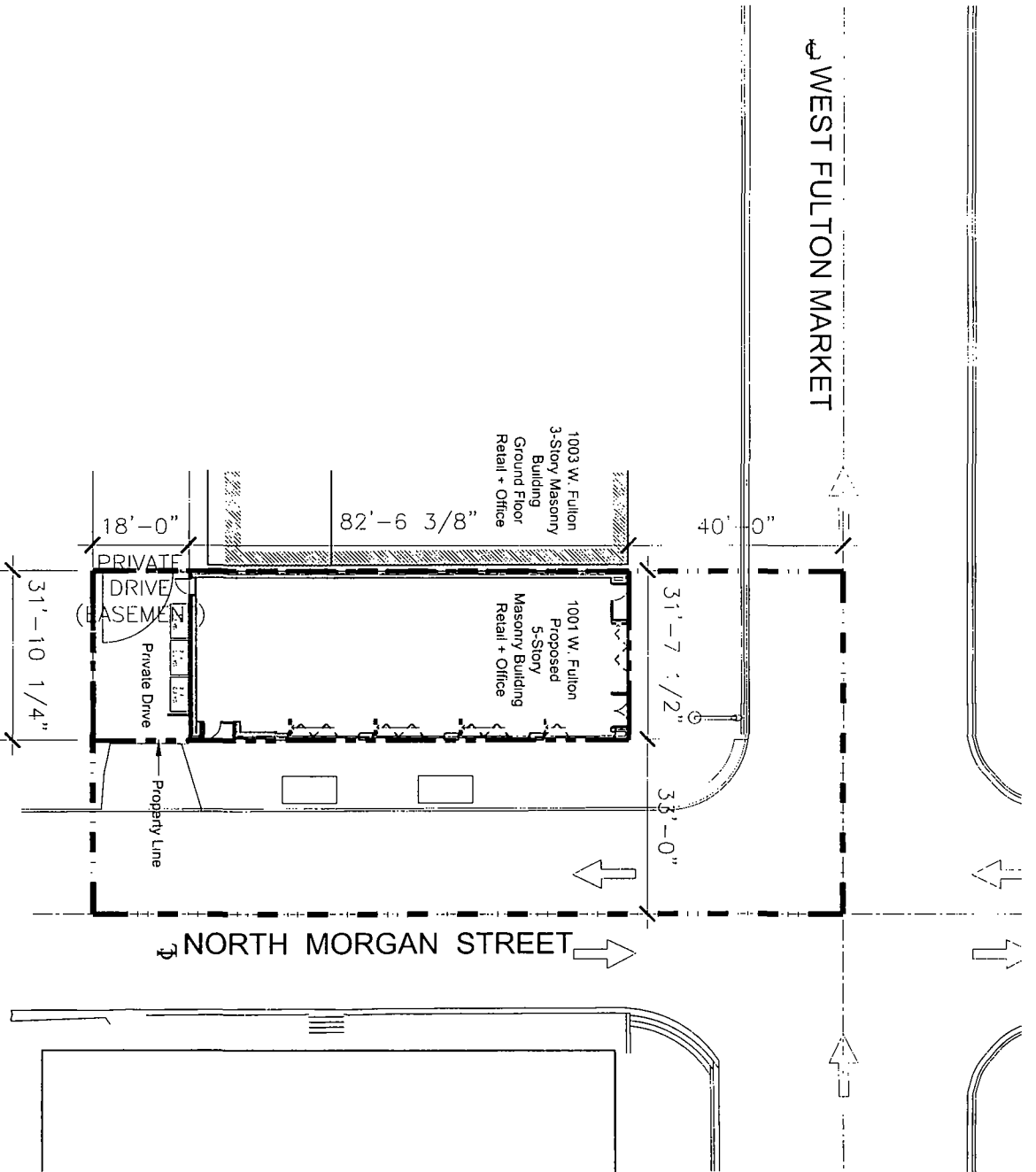

- LEGEND:
- — — — — PROPERTY LINE
 - - - - - PLANNED DEVELOPMENT BOUNDARY LINE

PLANNED DEVELOPMENT BOUNDARY AND PROPERTY LINE MAP

1" = 30'-0"

Applicant: Vequity LLC Series XIII Fulton
 Address: 1001 West Fulton Market
 Chicago, IL
 Introduction: May 24, 2017
 Plan Commission: _____, 2017



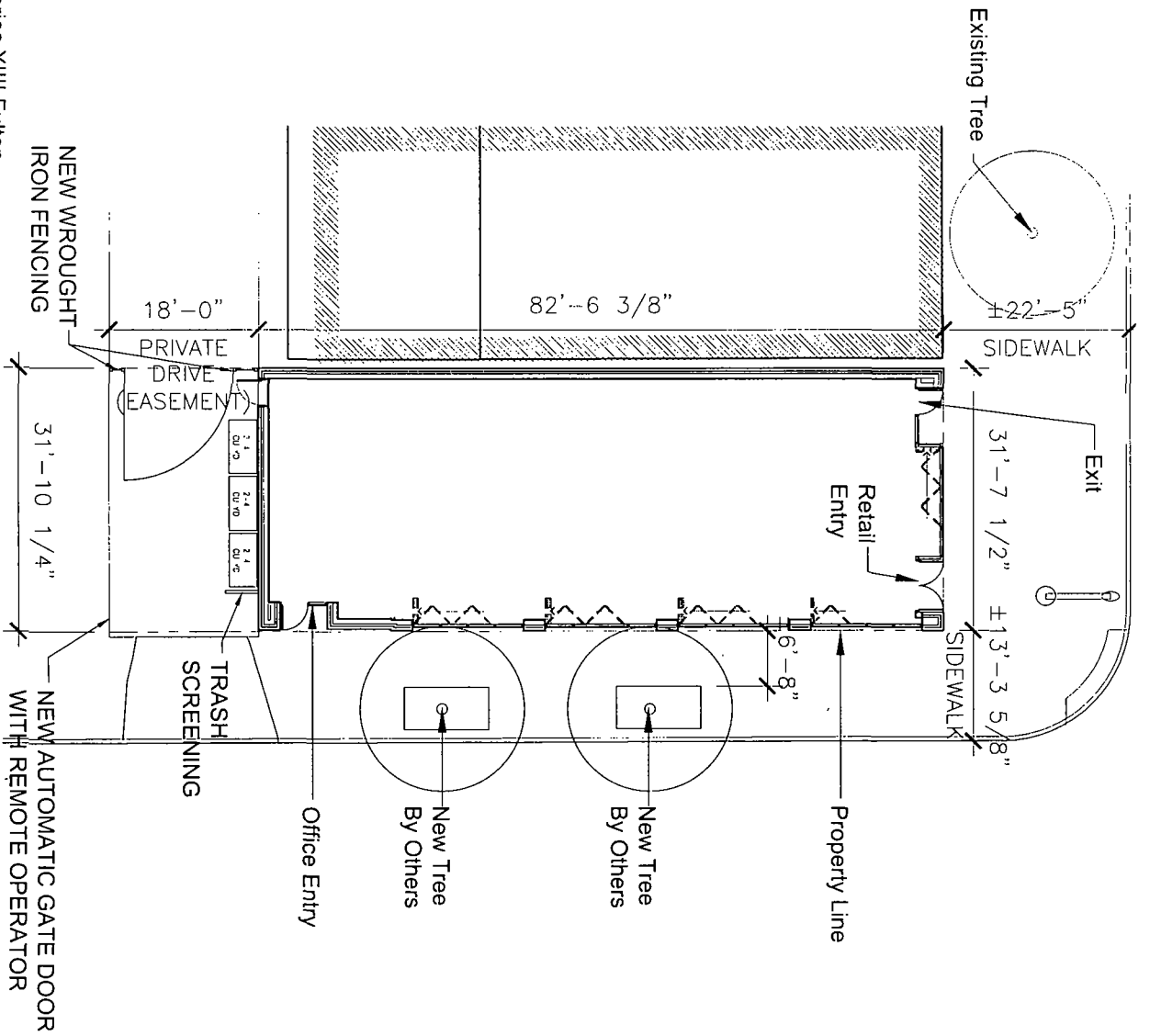

Applicant: Veguily LLC Series XIII Fulton
 Address: 1001 West Fulton Market
 Chicago, IL
 Introduction: May 24, 2017
 Plan Commission: _____, 2017

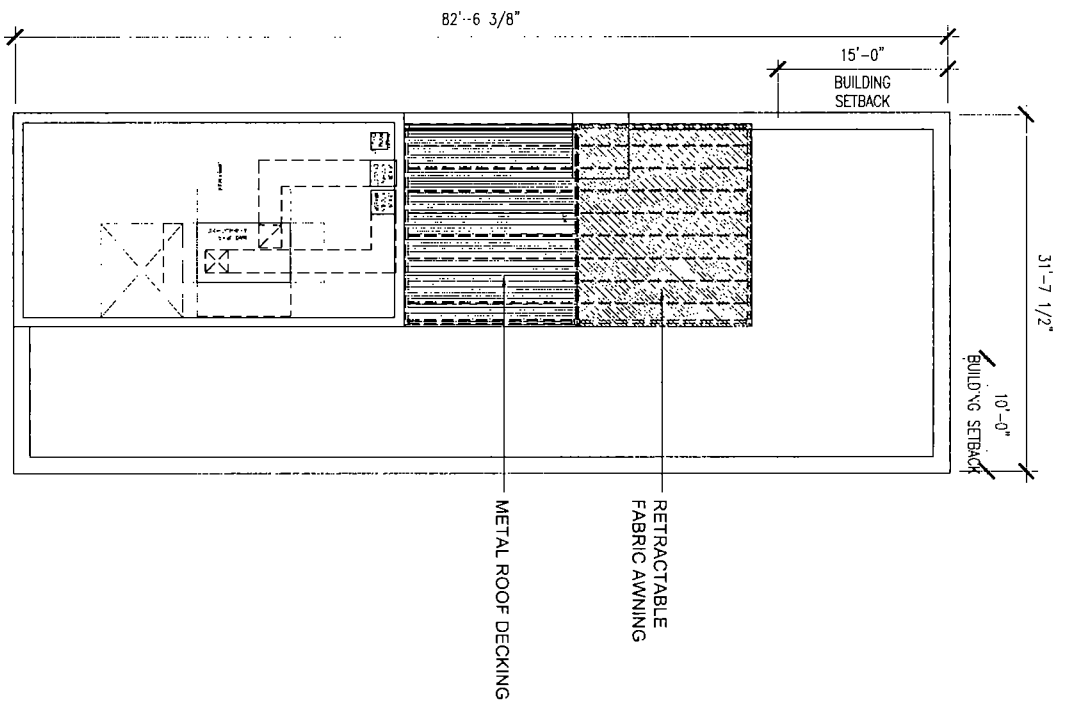
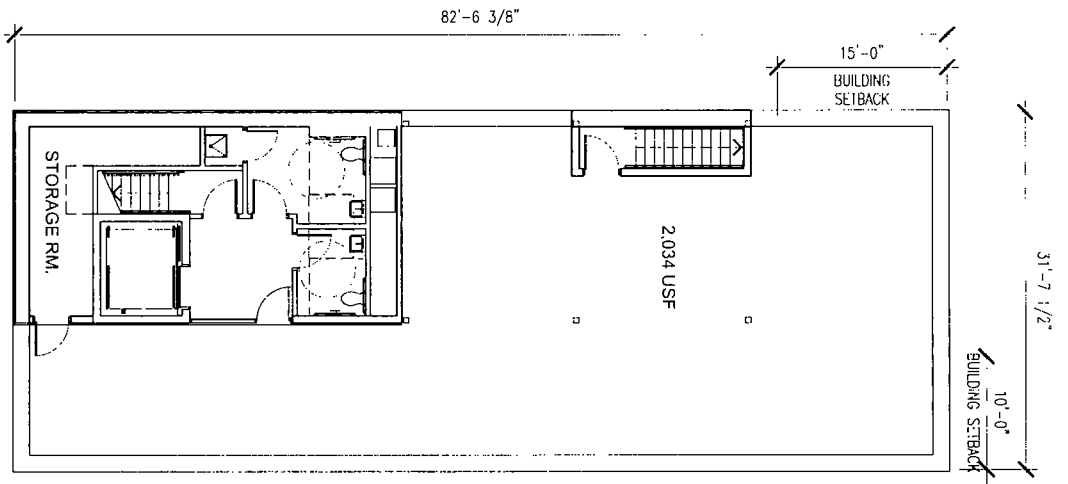

Applicant: Vequity LLC Series XIIIIL Fulton
 Address: 1001 West Fulton Market
 Chicago, IL
 Introduction: May 24, 2017
 Plan Commission: _____, 2017

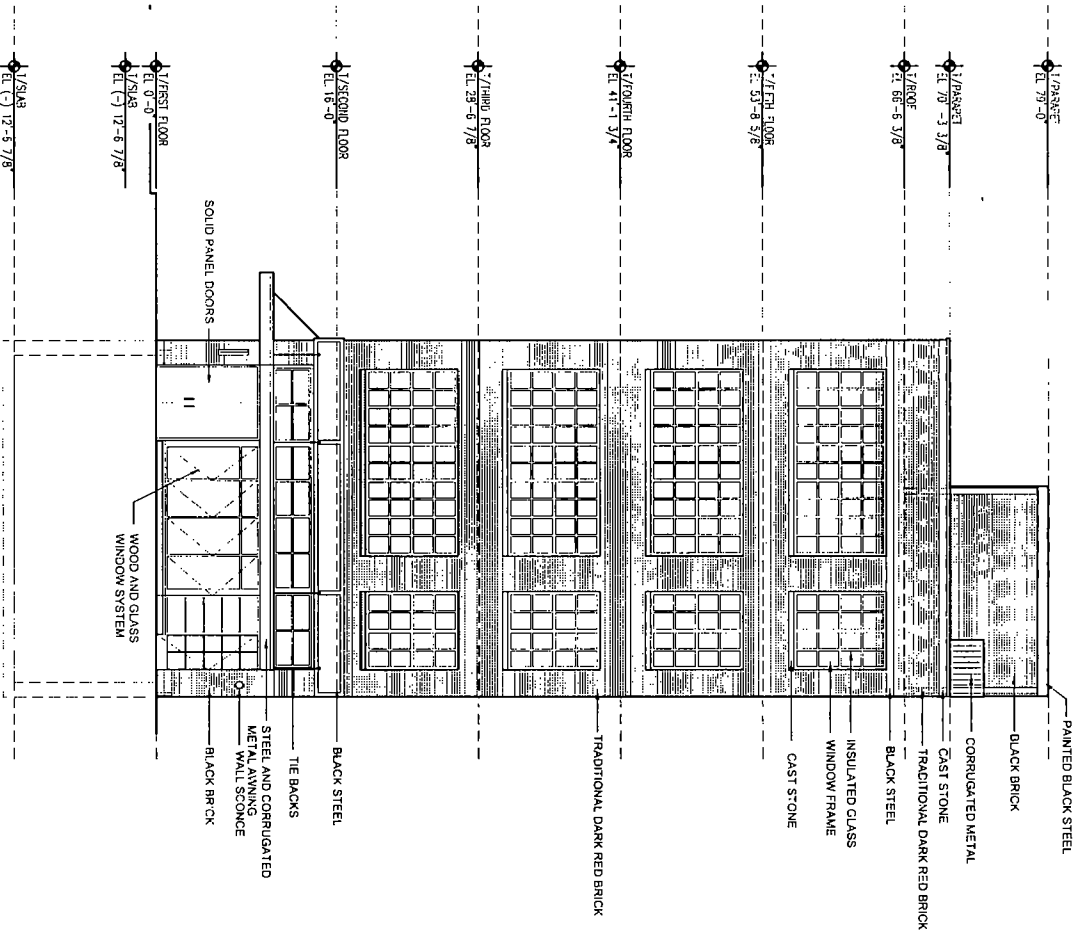

Applicant: Vequity LLC Series XIII Fullon
 Address: 1001 West Fulton Market
 Chicago, IL
 Introduction: May 24, 2017
 Plan Commission: _____, 2017

NORTH BUILDING ELEVATION

SCALE - 1/16"=1'-0"



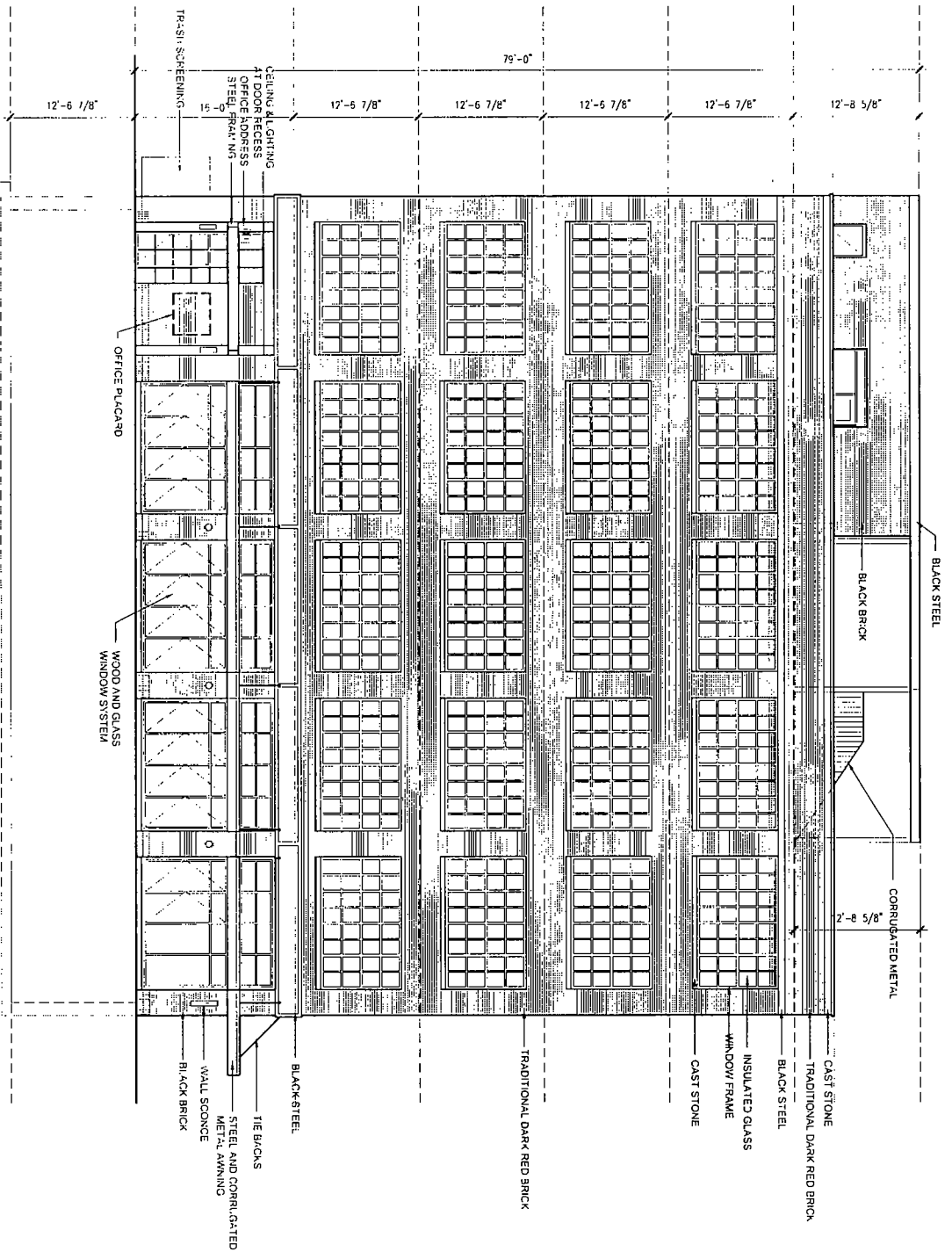

EAST BUILDING ELEVATION

SCALE - 1/16"=1'-0"



Applicant: Vequity LLC Series XIIIIL Fulton
 Address: 1001 West Fulton Market
 Chicago, IL
 Introduction: May 24, 2017
 Plan Commission: _____, 2017

Applicant: Vequily LLC Series XIII Fulton
 Address: 1001 West Fulton Market
 Chicago, IL
 Introduction: May 24, 2017
 Plan Commission: _____, 2017

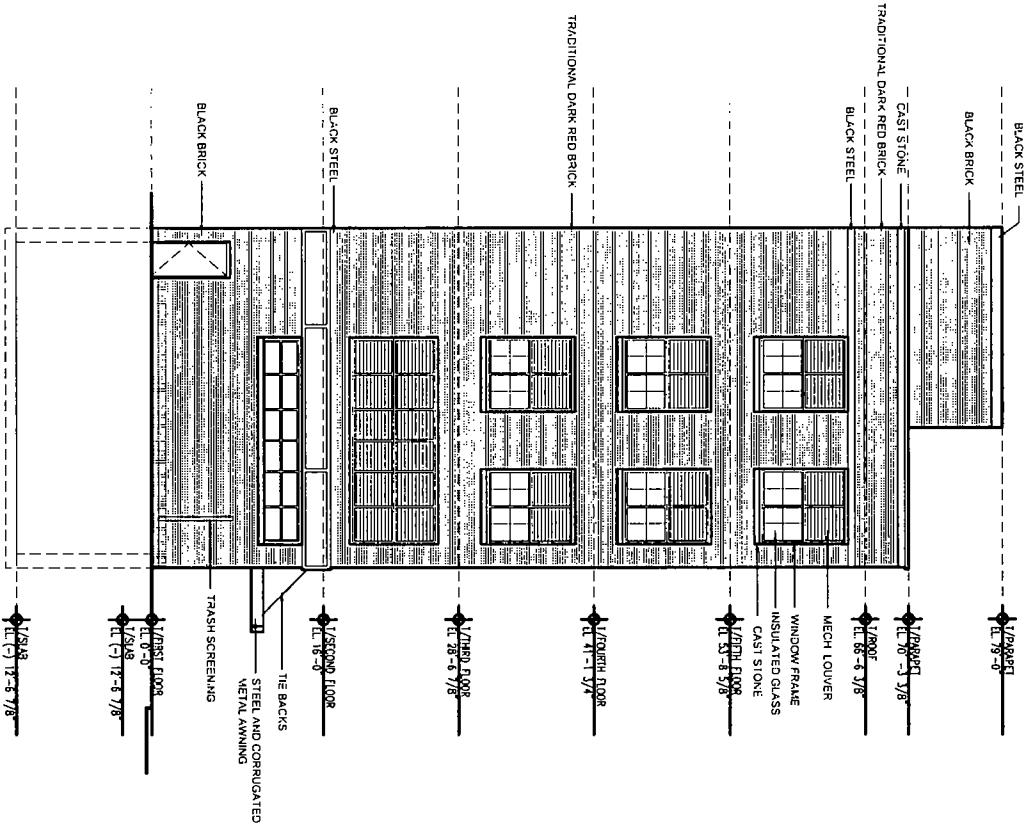

SOUTH BUILDING ELEVATION

SCALE - 1/16"=1'-0"



Applicant: Veguily LLC Series XIIIII Fulon
 Address: 1001 West Fulton Market
 Chicago, IL
 Introduction: May 24, 2017
 Plan Commission: _____, 2017

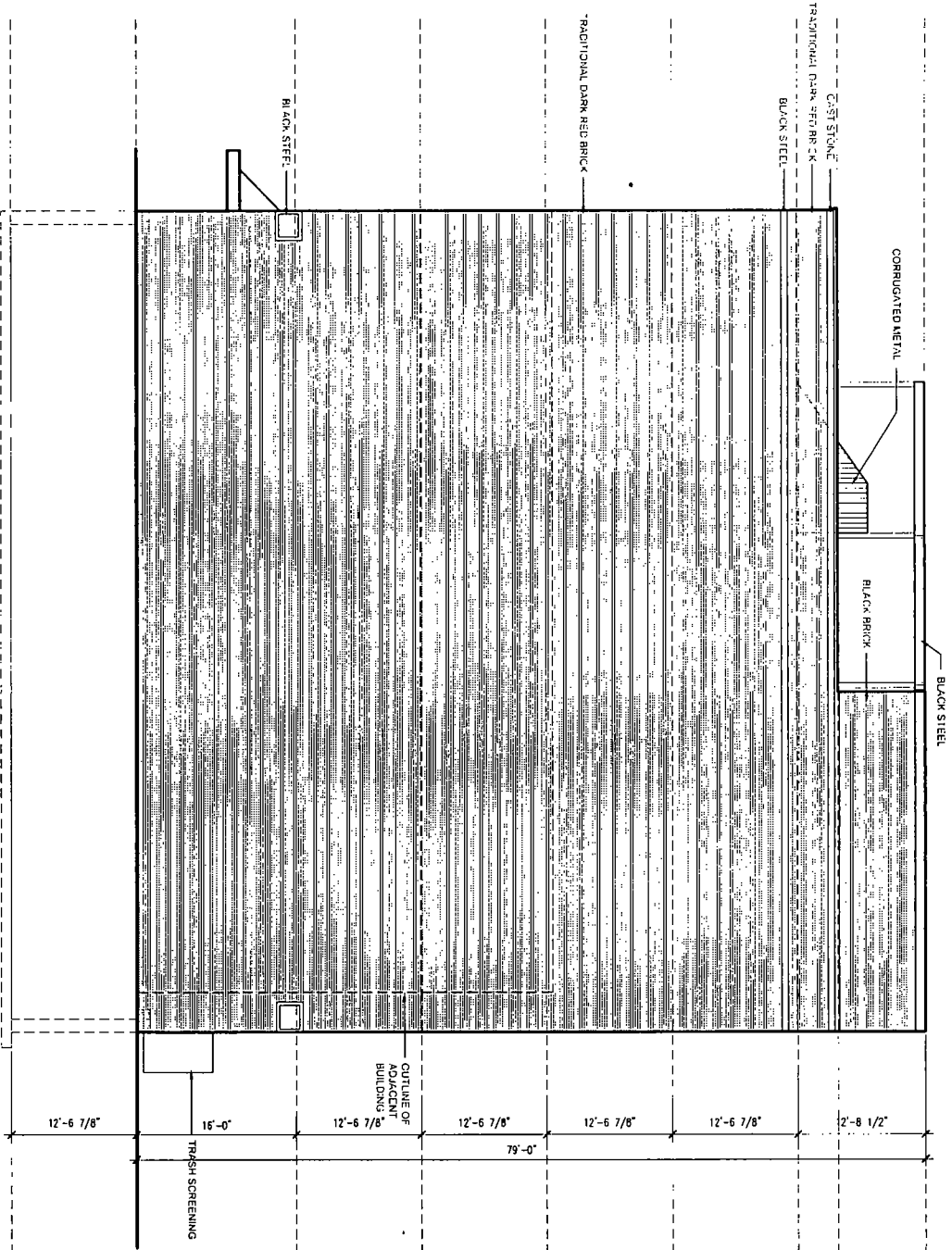

WEST BUILDING ELEVATION

SCALE - 1/16"=1'-0"



LEKIS
 architects + planners



COMBINED HEIGHTS 100 WEST FULTON MARKET CHICAGO, ILLINOIS
 PLAN NUMBER 17-02-0000

WOLF PACK CONSULTING, LLC BOUNDARY AND TOPOGRAPHIC SURVEY

PARCEL 1
 THAT PART OF LOT 1 IN BLOCK 2 IN CARPENTERS ADDITION TO CHICAGO, IN THE SOUTH-EAST 1/4 OF SECTION 8, TOWNSHIP 38 NORTH, RANGE 14 WEST AND RANGE 2 EAST, COUNTY OF COOK, ILLINOIS, AS SHOWN ON THE RECORD MAP OF SAID CARPENTERS ADDITION TO CHICAGO, AS RECORDED IN THE OFFICE OF THE CLERK OF RECORDS AND DEEDS OF SAID COUNTY OF COOK, ILLINOIS, IN VOLUME 11, PAGE 107, BEING THE SOUTH 11 DEGREES 11 MINUTES 27 SECONDS EAST ALONG THE EAST LINE OF LOT 1, A FOREBEAD 100.00 FEET TO THE SOUTH-EAST CORNER OF SAID CARPENTERS ADDITION TO CHICAGO, AS SHOWN ON SAID RECORD MAP, AND 81.81 FEET THENCE NORTH 00 DEGREES 00 MINUTES 00 SECONDS WEST 100.00 FEET TO THE POINT OF BEGINNING IN COOK COUNTY, ILLINOIS.

PARCEL 2
 EXAMINED PARCEL, THAT PART OF LOTS 1, 2, 3, 4 AND 5 IN BLOCK 2 IN CARPENTERS ADDITION TO CHICAGO, IN THE SOUTH-EAST 1/4 OF SECTION 8, TOWNSHIP 38 NORTH, RANGE 14 WEST AND RANGE 2 EAST, COUNTY OF COOK, ILLINOIS, AS SHOWN ON THE RECORD MAP OF SAID CARPENTERS ADDITION TO CHICAGO, AS RECORDED IN THE OFFICE OF THE CLERK OF RECORDS AND DEEDS OF SAID COUNTY OF COOK, ILLINOIS, IN VOLUME 11, PAGE 107, BEING THE SOUTH 11 DEGREES 11 MINUTES 27 SECONDS EAST ALONG THE EAST LINE OF LOT 1, A FOREBEAD 100.00 FEET TO THE SOUTH-EAST CORNER OF SAID CARPENTERS ADDITION TO CHICAGO, AS SHOWN ON SAID RECORD MAP, AND 81.81 FEET THENCE NORTH 00 DEGREES 00 MINUTES 00 SECONDS WEST 100.00 FEET TO THE POINT OF BEGINNING IN COOK COUNTY, ILLINOIS.

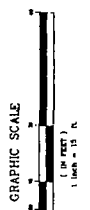

- LEGEND**
- 1. BOUNDARY POINTS
 - 2. BOUNDARY LINES
 - 3. ADJACENT PROPERTY
 - 4. EXISTING UTILITY LINES
 - 5. EXISTING UTILITY POINTS
 - 6. CONCRETE UTILITY POINTS
 - 7. CONCRETE UTILITY LINES
 - 8. CONCRETE UTILITY TRENCHES
 - 9. CONCRETE UTILITY TRENCHES
 - 10. CONCRETE UTILITY TRENCHES
 - 11. CONCRETE UTILITY TRENCHES
 - 12. CONCRETE UTILITY TRENCHES
 - 13. CONCRETE UTILITY TRENCHES
 - 14. CONCRETE UTILITY TRENCHES
 - 15. CONCRETE UTILITY TRENCHES
 - 16. CONCRETE UTILITY TRENCHES
 - 17. CONCRETE UTILITY TRENCHES
 - 18. CONCRETE UTILITY TRENCHES
 - 19. CONCRETE UTILITY TRENCHES
 - 20. CONCRETE UTILITY TRENCHES
 - 21. CONCRETE UTILITY TRENCHES
 - 22. CONCRETE UTILITY TRENCHES
 - 23. CONCRETE UTILITY TRENCHES
 - 24. CONCRETE UTILITY TRENCHES
 - 25. CONCRETE UTILITY TRENCHES
 - 26. CONCRETE UTILITY TRENCHES
 - 27. CONCRETE UTILITY TRENCHES
 - 28. CONCRETE UTILITY TRENCHES
 - 29. CONCRETE UTILITY TRENCHES
 - 30. CONCRETE UTILITY TRENCHES
 - 31. CONCRETE UTILITY TRENCHES
 - 32. CONCRETE UTILITY TRENCHES
 - 33. CONCRETE UTILITY TRENCHES
 - 34. CONCRETE UTILITY TRENCHES
 - 35. CONCRETE UTILITY TRENCHES
 - 36. CONCRETE UTILITY TRENCHES
 - 37. CONCRETE UTILITY TRENCHES
 - 38. CONCRETE UTILITY TRENCHES
 - 39. CONCRETE UTILITY TRENCHES
 - 40. CONCRETE UTILITY TRENCHES
 - 41. CONCRETE UTILITY TRENCHES
 - 42. CONCRETE UTILITY TRENCHES
 - 43. CONCRETE UTILITY TRENCHES
 - 44. CONCRETE UTILITY TRENCHES
 - 45. CONCRETE UTILITY TRENCHES
 - 46. CONCRETE UTILITY TRENCHES
 - 47. CONCRETE UTILITY TRENCHES
 - 48. CONCRETE UTILITY TRENCHES
 - 49. CONCRETE UTILITY TRENCHES
 - 50. CONCRETE UTILITY TRENCHES
 - 51. CONCRETE UTILITY TRENCHES
 - 52. CONCRETE UTILITY TRENCHES
 - 53. CONCRETE UTILITY TRENCHES
 - 54. CONCRETE UTILITY TRENCHES
 - 55. CONCRETE UTILITY TRENCHES
 - 56. CONCRETE UTILITY TRENCHES
 - 57. CONCRETE UTILITY TRENCHES
 - 58. CONCRETE UTILITY TRENCHES
 - 59. CONCRETE UTILITY TRENCHES
 - 60. CONCRETE UTILITY TRENCHES
 - 61. CONCRETE UTILITY TRENCHES
 - 62. CONCRETE UTILITY TRENCHES
 - 63. CONCRETE UTILITY TRENCHES
 - 64. CONCRETE UTILITY TRENCHES
 - 65. CONCRETE UTILITY TRENCHES
 - 66. CONCRETE UTILITY TRENCHES
 - 67. CONCRETE UTILITY TRENCHES
 - 68. CONCRETE UTILITY TRENCHES
 - 69. CONCRETE UTILITY TRENCHES
 - 70. CONCRETE UTILITY TRENCHES
 - 71. CONCRETE UTILITY TRENCHES
 - 72. CONCRETE UTILITY TRENCHES
 - 73. CONCRETE UTILITY TRENCHES
 - 74. CONCRETE UTILITY TRENCHES
 - 75. CONCRETE UTILITY TRENCHES
 - 76. CONCRETE UTILITY TRENCHES
 - 77. CONCRETE UTILITY TRENCHES
 - 78. CONCRETE UTILITY TRENCHES
 - 79. CONCRETE UTILITY TRENCHES
 - 80. CONCRETE UTILITY TRENCHES
 - 81. CONCRETE UTILITY TRENCHES
 - 82. CONCRETE UTILITY TRENCHES
 - 83. CONCRETE UTILITY TRENCHES
 - 84. CONCRETE UTILITY TRENCHES
 - 85. CONCRETE UTILITY TRENCHES
 - 86. CONCRETE UTILITY TRENCHES
 - 87. CONCRETE UTILITY TRENCHES
 - 88. CONCRETE UTILITY TRENCHES
 - 89. CONCRETE UTILITY TRENCHES
 - 90. CONCRETE UTILITY TRENCHES
 - 91. CONCRETE UTILITY TRENCHES
 - 92. CONCRETE UTILITY TRENCHES
 - 93. CONCRETE UTILITY TRENCHES
 - 94. CONCRETE UTILITY TRENCHES
 - 95. CONCRETE UTILITY TRENCHES
 - 96. CONCRETE UTILITY TRENCHES
 - 97. CONCRETE UTILITY TRENCHES
 - 98. CONCRETE UTILITY TRENCHES
 - 99. CONCRETE UTILITY TRENCHES
 - 100. CONCRETE UTILITY TRENCHES

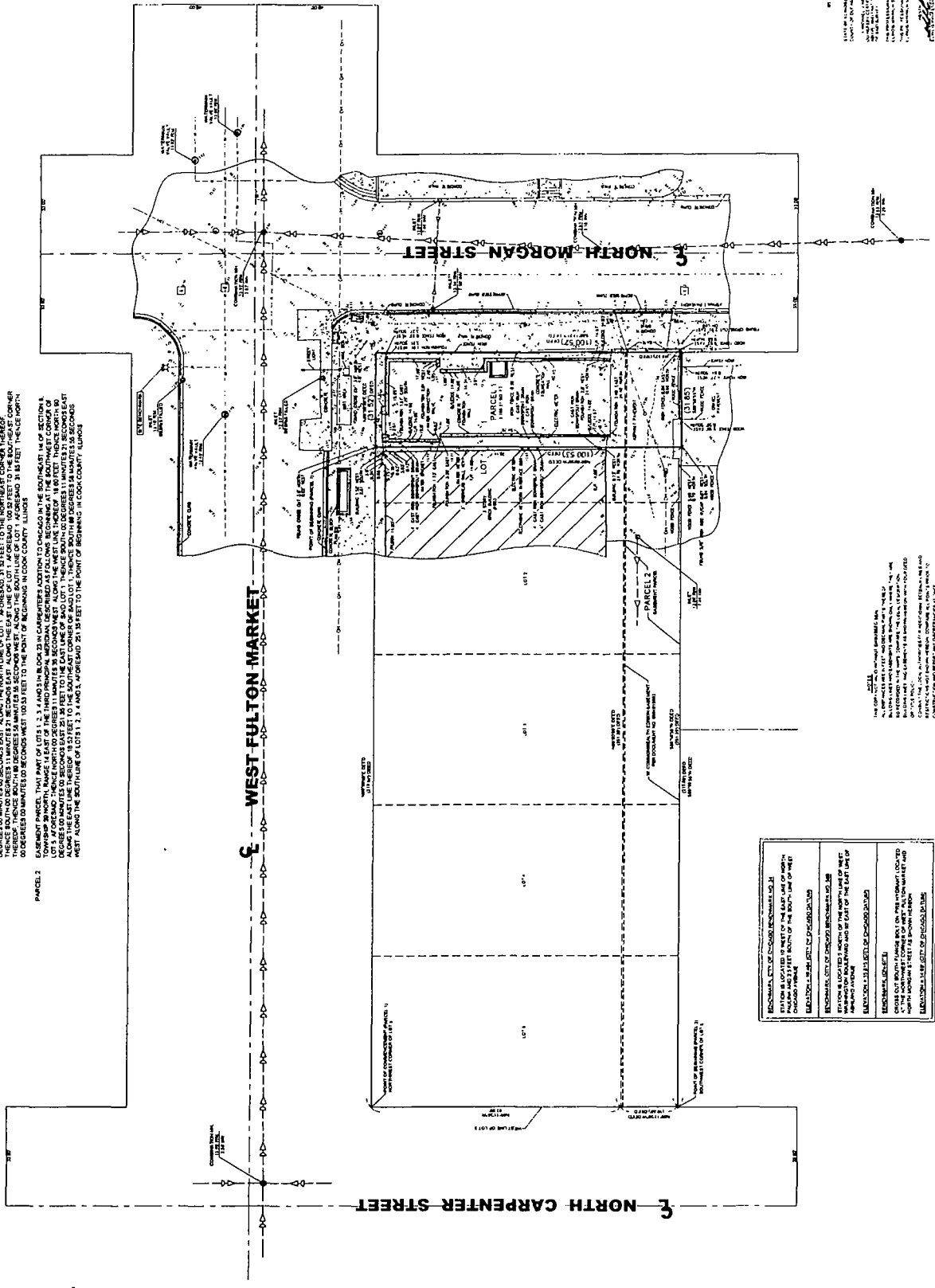

RECORDS, CITY OF CHICAGO, RECORDS AND DEEDS
 THE CITY OF CHICAGO, RECORDS AND DEEDS OFFICE HAS REVIEWED THIS SURVEY AND FOUND IT TO BE IN ACCORDANCE WITH THE CITY OF CHICAGO RECORDS AND DEEDS ACT, CHICAGO ORDINANCE NO. 4-11-1907, AS AMENDED.

RECORDS, CITY OF CHICAGO, RECORDS AND DEEDS
 THE CITY OF CHICAGO, RECORDS AND DEEDS OFFICE HAS REVIEWED THIS SURVEY AND FOUND IT TO BE IN ACCORDANCE WITH THE CITY OF CHICAGO RECORDS AND DEEDS ACT, CHICAGO ORDINANCE NO. 4-11-1907, AS AMENDED.

RECORDS, CITY OF CHICAGO, RECORDS AND DEEDS
 THE CITY OF CHICAGO, RECORDS AND DEEDS OFFICE HAS REVIEWED THIS SURVEY AND FOUND IT TO BE IN ACCORDANCE WITH THE CITY OF CHICAGO RECORDS AND DEEDS ACT, CHICAGO ORDINANCE NO. 4-11-1907, AS AMENDED.

RECORDS, CITY OF CHICAGO, RECORDS AND DEEDS
 THE CITY OF CHICAGO, RECORDS AND DEEDS OFFICE HAS REVIEWED THIS SURVEY AND FOUND IT TO BE IN ACCORDANCE WITH THE CITY OF CHICAGO RECORDS AND DEEDS ACT, CHICAGO ORDINANCE NO. 4-11-1907, AS AMENDED.

RECORDS, CITY OF CHICAGO, RECORDS AND DEEDS
 THE CITY OF CHICAGO, RECORDS AND DEEDS OFFICE HAS REVIEWED THIS SURVEY AND FOUND IT TO BE IN ACCORDANCE WITH THE CITY OF CHICAGO RECORDS AND DEEDS ACT, CHICAGO ORDINANCE NO. 4-11-1907, AS AMENDED.

PREPARED FOR	WOLF PACK CONSULTING
DRAWN BY	APRIL 11, 2017
SCALE	AS SHOWN
DATE	17 APR 11 2017
JOB NO.	17-02-0000

WOLF PACK CONSULTING, LLC
 100 WEST FULTON MARKET, CHICAGO, ILLINOIS 60607
 TEL: 773.327.1111
 WWW.WOLFPAKCONSULTING.COM

NOTICE TO CONTRACTORS
 THE SURVEYOR HAS REVIEWED THIS SURVEY AND FOUND IT TO BE IN ACCORDANCE WITH THE CITY OF CHICAGO RECORDS AND DEEDS ACT, CHICAGO ORDINANCE NO. 4-11-1907, AS AMENDED.



Dykema Gossett PLLC
 10 S. Wacker Drive
 Suite 2300
 Chicago, IL 60606
 WWW.DYKEMA.COM
 Tel: (312) 876-1700
 Fax: (312) 876-1155
Andrew P. Scott
 Direct Dial: 312-627-8325
 Direct Fax: 866-950-3678
 Email: APScott@dykema.com

May 17, 2017

Honorable Daniel S. Solis
 Chairman, Committee on Zoning
 Landmarks and Building Standards
 121 North LaSalle Street, Room 200
 Chicago, Illinois 60602

The undersigned, Andrew Scott, being first duly sworn on oath deposes and states the following:

The undersigned certifies that he has complied with the requirements of Section 17-13-0107 of the Chicago Zoning Ordinance by sending written notices to such property owners who appear to be the owners of the property within the subject area not solely owned by the owner of the subject property, and to the owners of all property within 250 feet in each direction of the lot line of the subject property, exclusive of public roads, streets, alleys and other public ways, or at total distance limited to 400 feet. Said "written notice" was sent by First Class U.S. Mail, no more than 30 days before filing the application.

The undersigned certifies that the notice contained the address of the property sought to be rezoned; a statement of the intended use of the property; the name and address of the applicant; the name and address of the owner; and a statement that the applicant intends to file the application for a change in zoning on approximately May 17, 2017.

The undersigned certifies that the applicant has made a bona fide effort to determine the addresses of the parties to be notified under Section 17-13-0107 of the Chicago Zoning Ordinance, and that the accompanying list of names and addresses of surrounding property owners within 250 feet of the subject site is a complete list containing the names and addresses of the people required to be served.

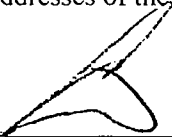

 Andrew P. Scott
 Dykema Gossett PLLC

Subscribed and Sworn to before me this
 17th day of May, 2017.

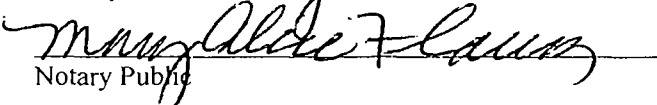

 Notary Public





Dykema Gossett PLLC
10 S Wacker Drive
Suite 2300
Chicago, IL 60606

WWW.DYKEMA.COM

Tel: (312) 876-1700

Fax: (312) 876-1155

Andrew P. Scott

Direct Dial: 312-627-8325

Direct Fax: 866-950-3678

Email: APScott@dykema.com

May 17, 2017

Dear Property Owner:

In accordance with the requirements for an Amendment to the Chicago Zoning Ordinance, specifically Section 17-13-0107, please be informed that on or about May 17, 2017, the undersigned intends to file an application for a change in zoning for the property commonly known as 1001 West Fulton Market (the "Property") from C1-1 Neighborhood Commercial District to DX-3 Downtown Mixed-Use District and then to Business Planned Development.

The applicant proposes to develop a five story building (plus amenity penthouse) with approximately 2,600 sf of ground floor retail and office/commercial uses above. No parking spaces are proposed.

The owner of the Property and applicant is Vequity LLC Series XIII Fulton, and its address is 400 North State Street, Suite 400, Chicago, Illinois 60654. The contact person for the application is the undersigned, Andrew Scott. My address is 10 South Wacker Drive, Suite 2300, Chicago, Illinois 60606. I can be reached at (312) 627-8325.

Please note that the applicant is not seeking to rezone or purchase your property. The applicant is required by law to send this notice because you own property within 250 feet of the property to be rezoned.

Very truly yours,

Andrew P. Scott
Attorney

19211
INTRO. DATE:
MAY 24, 2017

CITY OF CHICAGO

APPLICATION FOR AN AMENDMENT TO
THE CHICAGO ZONING ORDINANCE

1. ADDRESS of the property Applicant is seeking to rezone:

1001 West Fulton Market

2. Ward Number that property is located in: 27

3. APPLICANT Vequity LLC Series XIII Fulton

ADDRESS 400 North State Street, Suite 400

CITY Chicago STATE IL ZIP CODE 60654

PHONE (312) 985-0974 CONTACT PERSON Chris Ileki

4. Is the applicant the owner of the property? YES NO

If the applicant is not the owner of the property, please provide the following information regarding the owner and attach written authorization from the owner allowing the application to proceed.

OWNER Same

ADDRESS _____

CITY _____ STATE _____ ZIP CODE _____

PHONE _____ CONTACT PERSON _____

5. If the Applicant/Owner of the property has obtained a lawyer as their representative for the rezoning, please provide the following information:

ATTORNEY Andrew Scott

ADDRESS 10 South Wacker Drive CITY Chicago, IL

PHONE (312) 627-8325 FAX _____

6. If the applicant is a corporation please provide the names of all shareholders as disclosed on the Economic Disclosure Statements.

The applicant has no shareholders since it is a limited liability company.

7. On what date did the owner acquire legal title to the subject property? 4/17/17

8. Has the present owner previously rezoned this property? If yes, when?
No

9. Present Zoning District C1-1
Proposed Zoning District DX-3 Downtown Mixed-Use District and then to a business planned development.

10. Lot size in square feet (or dimensions) 3168.39 square feet

11. Current Use of the property The property is vacant.
Reason for rezoning the property To allow for the development of a retail/commercial building.

12. Describe the proposed use of the property after the rezoning. Indicate the number of dwelling units; number of parking spaces; approximate square footage of any commercial space; and height of the proposed building. (BE SPECIFIC)
The applicant proposes to develop a five story building (plus amenity penthouse) with approximately 2,600 sf of ground floor retail and office/commercial uses above. No parking spaces are proposed.

13. The Affordable Requirements Ordinance (ARO) requires on-site affordable housing units and/or a financial contribution for residential housing projects with ten or more units that receive a zoning change, which, among other triggers, increases the allowable floor area, or, for existing Planned Developments, increases the number of units (see attached fact sheet or visit www.cityofchicago.org/ARO for more information). Is this project subject to the ARO?
YES _____ NO X

COUNTY OF COOK
STATE OF ILLINOIS

Chris Ilekis, being first duly sworn on oath, states that all of the above statements and the statements contained in the documents submitted herewith are true and correct.



Signature of Applicant
Vequity LLC Series XIII Fulton, an Illinois
limited liability company

Subscribed and Sworn to before me this
11 day of May, 2017.



Notary Public

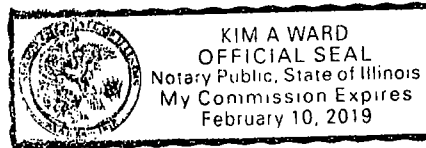

For Office Use Only

Date of Introduction: _____

File Number: _____

Ward: _____

**CITY OF CHICAGO
ECONOMIC DISCLOSURE STATEMENT
AND AFFIDAVIT**

SECTION I -- GENERAL INFORMATION

A. Legal name of the Disclosing Party submitting this EDS. Include d/b/a/ if applicable:

Vequity LLC Series XIII Fulton

Check ONE of the following three boxes:

Indicate whether the Disclosing Party submitting this EDS is:

1. the Applicant

OR

2. a legal entity holding a direct or indirect interest in the Applicant. State the legal name of the Applicant in which the Disclosing Party holds an interest: _____

OR

3. a legal entity with a right of control (see Section II.B.1.) State the legal name of the entity in which the Disclosing Party holds a right of control: _____

B. Business address of the Disclosing Party: 400 N. State Street, Suite 400
Chicago, IL 60654

C. Telephone: 312-985-0974 Fax: _____ Email: c.ilekis@vequity.com

D. Name of contact person: Christopher Ilekis

E. Federal Employer Identification No. (if you have one): _____

F. Brief description of contract, transaction or other undertaking (referred to below as the "Matter") to which this EDS pertains. (Include project number and location of property, if applicable):

Map amendment for 1001 West Fulton Market

G. Which City agency or department is requesting this EDS? DPD

If the Matter is a contract being handled by the City's Department of Procurement Services, please complete the following:

Specification # _____ and Contract # _____

SECTION II -- DISCLOSURE OF OWNERSHIP INTERESTS

A. NATURE OF THE DISCLOSING PARTY

1. Indicate the nature of the Disclosing Party:

- | | |
|---|---|
| <input type="checkbox"/> Person | <input checked="" type="checkbox"/> Limited liability company |
| <input type="checkbox"/> Publicly registered business corporation | <input type="checkbox"/> Limited liability partnership |
| <input type="checkbox"/> Privately held business corporation | <input type="checkbox"/> Joint venture |
| <input type="checkbox"/> Sole proprietorship | <input type="checkbox"/> Not-for-profit corporation |
| <input type="checkbox"/> General partnership | (Is the not-for-profit corporation also a 501(c)(3))? |
| <input type="checkbox"/> Limited partnership | <input type="checkbox"/> Yes <input type="checkbox"/> No |
| <input type="checkbox"/> Trust | <input type="checkbox"/> Other (please specify) |

2. For legal entities, the state (or foreign country) of incorporation or organization, if applicable:

Illinois

3. For legal entities not organized in the State of Illinois: Has the organization registered to do business in the State of Illinois as a foreign entity?

- Yes No N/A

B. IF THE DISCLOSING PARTY IS A LEGAL ENTITY:

1. List below the full names and titles of all executive officers and all directors of the entity.

NOTE: For not-for-profit corporations, also list below all members, if any, which are legal entities. If there are no such members, write "no members." For trusts, estates or other similar entities, list below the legal titleholder(s).

If the entity is a general partnership, limited partnership, limited liability company, limited liability partnership or joint venture, list below the name and title of each general partner, managing member, manager or any other person or entity that controls the day-to-day management of the Disclosing Party. **NOTE:** Each legal entity listed below must submit an EDS on its own behalf.

Name	Title
<u>Vequity Manager, LLC</u>	<u>Manager</u>
_____	_____
_____	_____
_____	_____

2. Please provide the following information concerning each person or entity having a direct or indirect beneficial interest (including ownership) in excess of 7.5% of the Disclosing Party. Examples of such an interest include shares in a corporation, partnership interest in a partnership or joint venture,

interest of a member or manager in a limited liability company, or interest of a beneficiary of a trust, estate or other similar entity. If none, state "None." **NOTE:** Pursuant to Section 2-154-030 of the Municipal Code of Chicago ("Municipal Code"), the City may require any such additional information from any applicant which is reasonably intended to achieve full disclosure.

Name	Business Address	Percentage Interest in the Disclosing Party
Christopher Ilekis	400 N State Street, #400, Chicago, IL 60654	42.9%
Ryan Murphy	400 N State Street, #400, Chicago, IL 60654	42.9%
Anthony Campagni	1850 W Division Street, Chicago, IL 60622	8.5%

SECTION III -- BUSINESS RELATIONSHIPS WITH CITY ELECTED OFFICIALS

Has the Disclosing Party had a "business relationship," as defined in Chapter 2-156 of the Municipal Code, with any City elected official in the 12 months before the date this EDS is signed?

- Yes No

If yes, please identify below the name(s) of such City elected official(s) and describe such relationship(s):

SECTION IV -- DISCLOSURE OF SUBCONTRACTORS AND OTHER RETAINED PARTIES

The Disclosing Party must disclose the name and business address of each subcontractor, attorney, lobbyist, accountant, consultant and any other person or entity whom the Disclosing Party has retained or expects to retain in connection with the Matter, as well as the nature of the relationship, and the total amount of the fees paid or estimated to be paid. The Disclosing Party is not required to disclose employees who are paid solely through the Disclosing Party's regular payroll.

"Lobbyist" means any person or entity who undertakes to influence any legislative or administrative action on behalf of any person or entity other than: (1) a not-for-profit entity, on an unpaid basis, or (2) himself. "Lobbyist" also means any person or entity any part of whose duties as an employee of another includes undertaking to influence any legislative or administrative action.

If the Disclosing Party is uncertain whether a disclosure is required under this Section, the Disclosing Party must either ask the City whether disclosure is required or make the disclosure.

Name (indicate whether retained or anticipated to be retained)	Business Address	Relationship to Disclosing Party (subcontractor, attorney, lobbyist, etc.)	(indicate whether paid or estimated.) NOTE: "hourly rate" or "t.b.d." is not an acceptable response.
--	------------------	--	--

Ilekis Associates	233 W Jackson Blvd , Chicago, IL 60606	Architect	\$25,000 (est)
Andrew Scott	10 S Wacker Drive, Chicago, IL 60606	Attorney	\$15,000 (est)

(Add sheets if necessary)

Check here if the Disclosing Party has not retained, nor expects to retain, any such persons or entities.

SECTION V -- CERTIFICATIONS

A. COURT-ORDERED CHILD SUPPORT COMPLIANCE

Under Municipal Code Section 2-92-415, substantial owners of business entities that contract with the City must remain in compliance with their child support obligations throughout the contract's term.

Has any person who directly or indirectly owns 10% or more of the Disclosing Party been declared in arrearage on any child support obligations by any Illinois court of competent jurisdiction?

Yes
 No
 No person directly or indirectly owns 10% or more of the Disclosing Party.

If "Yes," has the person entered into a court-approved agreement for payment of all support owed and is the person in compliance with that agreement?

Yes
 No

B. FURTHER CERTIFICATIONS

1. Pursuant to Municipal Code Chapter 1-23, Article I ("Article I")(which the Applicant should consult for defined terms (e.g., "doing business") and legal requirements), if the Disclosing Party submitting this EDS is the Applicant and is doing business with the City, then the Disclosing Party certifies as follows: (i) neither the Applicant nor any controlling person is currently indicted or charged with, or has admitted guilt of, or has ever been convicted of, or placed under supervision for, any criminal offense involving actual, attempted, or conspiracy to commit bribery, theft, fraud, forgery, perjury, dishonesty or deceit against an officer or employee of the City or any sister agency; and (ii) the Applicant understands and acknowledges that compliance with Article I is a continuing requirement for doing business with the City. NOTE: If Article I applies to the Applicant, the permanent compliance timeframe in Article I supersedes some five-year compliance timeframes in certifications 2 and 3 below.

2. The Disclosing Party and, if the Disclosing Party is a legal entity, all of those persons or entities identified in Section II.B.1. of this EDS:

- a. are not presently debarred, suspended, proposed for debarment, declared ineligible or voluntarily excluded from any transactions by any federal, state or local unit of government;
- b. have not, within a five-year period preceding the date of this EDS, been convicted of a criminal offense, adjudged guilty, or had a civil judgment rendered against them in connection with: obtaining, attempting to obtain, or performing a public (federal, state or local) transaction or contract under a public transaction; a violation of federal or state antitrust statutes; fraud; embezzlement; theft; forgery; bribery; falsification or destruction of records; making false statements; or receiving stolen property;
- c. are not presently indicted for, or criminally or civilly charged by, a governmental entity (federal, state or local) with committing any of the offenses set forth in clause B.2.b. of this Section V;
- d. have not, within a five-year period preceding the date of this EDS, had one or more public transactions (federal, state or local) terminated for cause or default; and
- e. have not, within a five-year period preceding the date of this EDS, been convicted, adjudged guilty, or found liable in a civil proceeding, or in any criminal or civil action, including actions concerning environmental violations, instituted by the City or by the federal government, any state, or any other unit of local government.

3. The certifications in subparts 3, 4 and 5 concern:

- the Disclosing Party;
- any "Contractor" (meaning any contractor or subcontractor used by the Disclosing Party in connection with the Matter, including but not limited to all persons or legal entities disclosed under Section IV, "Disclosure of Subcontractors and Other Retained Parties");
- any "Affiliated Entity" (meaning a person or entity that, directly or indirectly: controls the Disclosing Party, is controlled by the Disclosing Party, or is, with the Disclosing Party, under common control of another person or entity. Indicia of control include, without limitation: interlocking management or ownership; identity of interests among family members, shared facilities and equipment; common use of employees; or organization of a business entity following the ineligibility of a business entity to do business with federal or state or local government, including the City, using substantially the same management, ownership, or principals as the ineligible entity); with respect to Contractors, the term Affiliated Entity means a person or entity that directly or indirectly controls the Contractor, is controlled by it, or, with the Contractor, is under common control of another person or entity;
- any responsible official of the Disclosing Party, any Contractor or any Affiliated Entity or any other official, agent or employee of the Disclosing Party, any Contractor or any Affiliated Entity, acting pursuant to the direction or authorization of a responsible official of the Disclosing Party, any Contractor or any Affiliated Entity (collectively "Agents").

Neither the Disclosing Party, nor any Contractor, nor any Affiliated Entity of either the Disclosing Party or any Contractor nor any Agents have, during the five years before the date this EDS is signed, or, with respect to a Contractor, an Affiliated Entity, or an Affiliated Entity of a Contractor during the five years before the date of such Contractor's or Affiliated Entity's contract or engagement in connection with the Matter:

- a. bribed or attempted to bribe, or been convicted or adjudged guilty of bribery or attempting to bribe, a public officer or employee of the City, the State of Illinois, or any agency of the federal government or of any state or local government in the United States of America, in that officer's or employee's official capacity;
- b. agreed or colluded with other bidders or prospective bidders, or been a party to any such agreement, or been convicted or adjudged guilty of agreement or collusion among bidders or prospective bidders, in restraint of freedom of competition by agreement to bid a fixed price or otherwise; or
- c. made an admission of such conduct described in a. or b. above that is a matter of record, but have not been prosecuted for such conduct; or
- d. violated the provisions of Municipal Code Section 2-92-610 (Living Wage Ordinance).

4. Neither the Disclosing Party, Affiliated Entity or Contractor, or any of their employees, officials, agents or partners, is barred from contracting with any unit of state or local government as a result of engaging in or being convicted of (1) bid-rigging in violation of 720 ILCS 5/33E-3; (2) bid-rotating in violation of 720 ILCS 5/33E-4; or (3) any similar offense of any state or of the United States of America that contains the same elements as the offense of bid-rigging or bid-rotating.

5. Neither the Disclosing Party nor any Affiliated Entity is listed on any of the following lists maintained by the Office of Foreign Assets Control of the U.S. Department of the Treasury or the Bureau of Industry and Security of the U.S. Department of Commerce or their successors: the Specially Designated Nationals List, the Denied Persons List, the Unverified List, the Entity List and the Debarred List.

6. The Disclosing Party understands and shall comply with the applicable requirements of Chapters 2-55 (Legislative Inspector General), 2-56 (Inspector General) and 2-156 (Governmental Ethics) of the Municipal Code.

7. If the Disclosing Party is unable to certify to any of the above statements in this Part B (Further Certifications), the Disclosing Party must explain below:

If the letters "NA," the word "None," or no response appears on the lines above, it will be conclusively presumed that the Disclosing Party certified to the above statements.

8. To the best of the Disclosing Party's knowledge after reasonable inquiry, the following is a complete list of all current employees of the Disclosing Party who were, at any time during the 12-month period preceding the execution date of this EDS, an employee, or elected or appointed official, of the City of Chicago (if none, indicate with "N/A" or "none").

N/A

9. To the best of the Disclosing Party's knowledge after reasonable inquiry, the following is a complete list of all gifts that the Disclosing Party has given or caused to be given, at any time during the 12-month period preceding the execution date of this EDS, to an employee, or elected or appointed official, of the City of Chicago. For purposes of this statement, a "gift" does not include: (i) anything made generally available to City employees or to the general public, or (ii) food or drink provided in the course of official City business and having a retail value of less than \$20 per recipient (if none, indicate with "N/A" or "none"). As to any gift listed below, please also list the name of the City recipient.

N/A

C. CERTIFICATION OF STATUS AS FINANCIAL INSTITUTION

1. The Disclosing Party certifies that the Disclosing Party (check one)

is

is not

a "financial institution" as defined in Section 2-32-455(b) of the Municipal Code.

2. If the Disclosing Party IS a financial institution, then the Disclosing Party pledges:

"We are not and will not become a predatory lender as defined in Chapter 2-32 of the Municipal Code. We further pledge that none of our affiliates is, and none of them will become, a predatory lender as defined in Chapter 2-32 of the Municipal Code. We understand that becoming a predatory lender or becoming an affiliate of a predatory lender may result in the loss of the privilege of doing business with the City."

If the Disclosing Party is unable to make this pledge because it or any of its affiliates (as defined in Section 2-32-455(b) of the Municipal Code) is a predatory lender within the meaning of Chapter 2-32 of the Municipal Code, explain here (attach additional pages if necessary):

If the letters "NA," the word "None," or no response appears on the lines above, it will be conclusively presumed that the Disclosing Party certified to the above statements.

D. CERTIFICATION REGARDING INTEREST IN CITY BUSINESS

Any words or terms that are defined in Chapter 2-156 of the Municipal Code have the same meanings when used in this Part D.

1. In accordance with Section 2-156-110 of the Municipal Code: Does any official or employee of the City have a financial interest in his or her own name or in the name of any other person or entity in the Matter?

Yes No

NOTE: If you checked "Yes" to Item D.1., proceed to Items D.2. and D.3. If you checked "No" to Item D.1., proceed to Part E.

2. Unless sold pursuant to a process of competitive bidding, or otherwise permitted, no City elected official or employee shall have a financial interest in his or her own name or in the name of any other person or entity in the purchase of any property that (i) belongs to the City, or (ii) is sold for taxes or assessments, or (iii) is sold by virtue of legal process at the suit of the City (collectively, "City Property Sale"). Compensation for property taken pursuant to the City's eminent domain power does not constitute a financial interest within the meaning of this Part D.

Does the Matter involve a City Property Sale?

Yes No

3. If you checked "Yes" to Item D.1., provide the names and business addresses of the City officials or employees having such interest and identify the nature of such interest:

Name	Business Address	Nature of Interest
------	------------------	--------------------

4. The Disclosing Party further certifies that no prohibited financial interest in the Matter will be acquired by any City official or employee.

E. CERTIFICATION REGARDING SLAVERY ERA BUSINESS

Please check either 1. or 2. below. If the Disclosing Party checks 2., the Disclosing Party must disclose below or in an attachment to this EDS all information required by paragraph 2. Failure to

comply with these disclosure requirements may make any contract entered into with the City in connection with the Matter voidable by the City.

X 1. The Disclosing Party verifies that the Disclosing Party has searched any and all records of the Disclosing Party and any and all predecessor entities regarding records of investments or profits from slavery or slaveholder insurance policies during the slavery era (including insurance policies issued to slaveholders that provided coverage for damage to or injury or death of their slaves), and the Disclosing Party has found no such records.

2. The Disclosing Party verifies that, as a result of conducting the search in step 1 above, the Disclosing Party has found records of investments or profits from slavery or slaveholder insurance policies. The Disclosing Party verifies that the following constitutes full disclosure of all such records, including the names of any and all slaves or slaveholders described in those records:

SECTION VI -- CERTIFICATIONS FOR FEDERALLY FUNDED MATTERS

NOTE: If the Matter is federally funded, complete this Section VI. If the Matter is not federally funded, proceed to Section VII. For purposes of this Section VI, tax credits allocated by the City and proceeds of debt obligations of the City are not federal funding.

A. CERTIFICATION REGARDING LOBBYING

1. List below the names of all persons or entities registered under the federal Lobbying Disclosure Act of 1995 who have made lobbying contacts on behalf of the Disclosing Party with respect to the Matter: *(Add sheets if necessary):*

(If no explanation appears or begins on the lines above, or if the letters "NA" or if the word "None" appear, it will be conclusively presumed that the Disclosing Party means that NO persons or entities registered under the Lobbying Disclosure Act of 1995 have made lobbying contacts on behalf of the Disclosing Party with respect to the Matter.)

2. The Disclosing Party has not spent and will not expend any federally appropriated funds to pay any person or entity listed in Paragraph A.1. above for his or her lobbying activities or to pay any person or entity to influence or attempt to influence an officer or employee of any agency, as defined by applicable federal law, a member of Congress, an officer or employee of Congress, or an employee of a member of Congress, in connection with the award of any federally funded contract, making any federally funded grant or loan, entering into any cooperative agreement, or to extend, continue, renew, amend, or modify any federally funded contract, grant, loan, or cooperative agreement.

3. The Disclosing Party will submit an updated certification at the end of each calendar quarter in which there occurs any event that materially affects the accuracy of the statements and information set forth in paragraphs A.1. and A.2. above.

4. The Disclosing Party certifies that either: (i) it is not an organization described in section 501(c)(4) of the Internal Revenue Code of 1986; or (ii) it is an organization described in section 501(c)(4) of the Internal Revenue Code of 1986 but has not engaged and will not engage in "Lobbying Activities".

5. If the Disclosing Party is the Applicant, the Disclosing Party must obtain certifications equal in form and substance to paragraphs A.1. through A.4. above from all subcontractors before it awards any subcontract and the Disclosing Party must maintain all such subcontractors' certifications for the duration of the Matter and must make such certifications promptly available to the City upon request.

B. CERTIFICATION REGARDING EQUAL EMPLOYMENT OPPORTUNITY

If the Matter is federally funded, federal regulations require the Applicant and all proposed subcontractors to submit the following information with their bids or in writing at the outset of negotiations.

Is the Disclosing Party the Applicant?

Yes

No

If "Yes," answer the three questions below:

1. Have you developed and do you have on file affirmative action programs pursuant to applicable federal regulations? (See 41 CFR Part 60-2.)

Yes

No

2. Have you filed with the Joint Reporting Committee, the Director of the Office of Federal Contract Compliance Programs, or the Equal Employment Opportunity Commission all reports due under the applicable filing requirements?

Yes

No

3. Have you participated in any previous contracts or subcontracts subject to the equal opportunity clause?

Yes

No

If you checked "No" to question 1. or 2. above, please provide an explanation:

SECTION VII -- ACKNOWLEDGMENTS, CONTRACT INCORPORATION, COMPLIANCE, PENALTIES, DISCLOSURE

The Disclosing Party understands and agrees that:

A. The certifications, disclosures, and acknowledgments contained in this EDS will become part of any contract or other agreement between the Applicant and the City in connection with the Matter, whether procurement, City assistance, or other City action, and are material inducements to the City's execution of any contract or taking other action with respect to the Matter. The Disclosing Party understands that it must comply with all statutes, ordinances, and regulations on which this EDS is based.

B. The City's Governmental Ethics and Campaign Financing Ordinances, Chapters 2-156 and 2-164 of the Municipal Code, impose certain duties and obligations on persons or entities seeking City contracts, work, business, or transactions. The full text of these ordinances and a training program is available on line at www.cityofchicago.org/Ethics, and may also be obtained from the City's Board of Ethics, 740 N.

Sedgwick St., Suite 500, Chicago, IL 60610, (312) 744-9660. The Disclosing Party must comply fully with the applicable ordinances.

C. If the City determines that any information provided in this EDS is false, incomplete or inaccurate, any contract or other agreement in connection with which it is submitted may be rescinded or be void or voidable, and the City may pursue any remedies under the contract or agreement (if not rescinded or void), at law, or in equity, including terminating the Disclosing Party's participation in the Matter and/or declining to allow the Disclosing Party to participate in other transactions with the City. Remedies at law for a false statement of material fact may include incarceration and an award to the City of treble damages.

D. It is the City's policy to make this document available to the public on its Internet site and/or upon request. Some or all of the information provided on this EDS and any attachments to this EDS may be made available to the public on the Internet, in response to a Freedom of Information Act request, or otherwise. By completing and signing this EDS, the Disclosing Party waives and releases any possible rights or claims which it may have against the City in connection with the public release of information contained in this EDS and also authorizes the City to verify the accuracy of any information submitted in this EDS.

E. The information provided in this EDS must be kept current. In the event of changes, the Disclosing Party must supplement this EDS up to the time the City takes action on the Matter. If the Matter is a contract being handled by the City's Department of Procurement Services, the Disclosing Party must update this EDS as the contract requires. **NOTE:** With respect to Matters subject to Article I of Chapter 1-23 of the Municipal Code (imposing **PERMANENT INELIGIBILITY** for certain specified offenses), the information provided herein regarding eligibility must be kept current for a longer period, as required by Chapter 1-23 and Section 2-154-020 of the Municipal Code.

The Disclosing Party represents and warrants that:

F.1. The Disclosing Party is not delinquent in the payment of any tax administered by the Illinois Department of Revenue, nor are the Disclosing Party or its Affiliated Entities delinquent in paying any fine, fee, tax or other charge owed to the City. This includes, but is not limited to, all water charges, sewer charges, license fees, parking tickets, property taxes or sales taxes.

F.2 If the Disclosing Party is the Applicant, the Disclosing Party and its Affiliated Entities will not use, nor permit their subcontractors to use, any facility listed by the U.S. E.P.A. on the federal Excluded Parties List System ("EPLS") maintained by the U. S. General Services Administration.

F.3 If the Disclosing Party is the Applicant, the Disclosing Party will obtain from any contractors/subcontractors hired or to be hired in connection with the Matter certifications equal in form and substance to those in F.1. and F.2. above and will not, without the prior written consent of the City, use any such contractor/subcontractor that does not provide such certifications or that the Disclosing Party has reason to believe has not provided or cannot provide truthful certifications.

NOTE: If the Disclosing Party cannot certify as to any of the items in F.1., F.2. or F.3. above, an explanatory statement must be attached to this EDS.

CERTIFICATION

Under penalty of perjury, the person signing below: (1) warrants that he/she is authorized to execute this EDS and Appendix A (if applicable) on behalf of the Disclosing Party, and (2) warrants that all certifications and statements contained in this EDS and Appendix A (if applicable) are true, accurate and complete as of the date furnished to the City.

Vequity LLC Series XIII Fulton
(Print or type name of Disclosing Party)

By: 
(Sign here)

Christopher Ilekis, Manager of Vequity Manager
(Print or type name of person signing)

Its Manager
(Print or type title of person signing)

Signed and sworn to before me on (date) May 11, 2017,
at Cook County, IL (state).

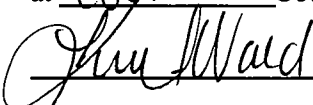
 Notary Public.
Commission expires: 2/10/19

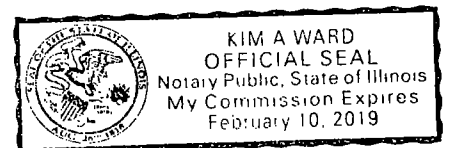

**CITY OF CHICAGO
ECONOMIC DISCLOSURE STATEMENT AND AFFIDAVIT
APPENDIX A**

FAMILIAL RELATIONSHIPS WITH ELECTED CITY OFFICIALS AND DEPARTMENT HEADS

This Appendix is to be completed only by (a) the Applicant, and (b) any legal entity which has a direct ownership interest in the Applicant exceeding 7.5 percent. It is not to be completed by any legal entity which has only an indirect ownership interest in the Applicant.

Under Municipal Code Section 2-154-015, the Disclosing Party must disclose whether such Disclosing Party or any “Applicable Party” or any Spouse or Domestic Partner thereof currently has a “familial relationship” with any elected city official or department head. A “familial relationship” exists if, as of the date this EDS is signed, the Disclosing Party or any “Applicable Party” or any Spouse or Domestic Partner thereof is related to the mayor, any alderman, the city clerk, the city treasurer or any city department head as spouse or domestic partner or as any of the following, whether by blood or adoption: parent, child, brother or sister, aunt or uncle, niece or nephew, grandparent, grandchild, father-in-law, mother-in-law, son-in-law, daughter-in-law, stepfather or stepmother, stepson or stepdaughter, stepbrother or stepsister or half-brother or half-sister.

“Applicable Party” means (1) all executive officers of the Disclosing Party listed in Section II.B.1.a., if the Disclosing Party is a corporation; all partners of the Disclosing Party, if the Disclosing Party is a general partnership; all general partners and limited partners of the Disclosing Party, if the Disclosing Party is a limited partnership; all managers, managing members and members of the Disclosing Party, if the Disclosing Party is a limited liability company; (2) all principal officers of the Disclosing Party; and (3) any person having more than a 7.5 percent ownership interest in the Disclosing Party. “Principal officers” means the president, chief operating officer, executive director, chief financial officer, treasurer or secretary of a legal entity or any person exercising similar authority.

Does the Disclosing Party or any “Applicable Party” or any Spouse or Domestic Partner thereof currently have a “familial relationship” with an elected city official or department head?

Yes

No

If yes, please identify below (1) the name and title of such person, (2) the name of the legal entity to which such person is connected; (3) the name and title of the elected city official or department head to whom such person has a familial relationship, and (4) the precise nature of such familial relationship.

**CITY OF CHICAGO
ECONOMIC DISCLOSURE STATEMENT AND AFFIDAVIT
APPENDIX B**

BUILDING CODE SCOFFLAW/PROBLEM LANDLORD CERTIFICATION

This Appendix is to be completed only by (a) the Applicant, and (b) any legal entity which has a direct ownership interest in the Applicant exceeding 7.5 percent (an "Owner"). It is not to be completed by any legal entity which has only an indirect ownership interest in the Applicant.

1. Pursuant to Municipal Code Section 2-154-010, is the Applicant or any Owner identified as a building code scofflaw or problem landlord pursuant to Section 2-92-416 of the Municipal Code?

Yes

No

2. If the Applicant is a legal entity publicly traded on any exchange, is any officer or director of the Applicant identified as a building code scofflaw or problem landlord pursuant to Section 2-92-416 of the Municipal Code?

Yes

No

Not Applicable

3. If yes to (1) or (2) above, please identify below the name of the person or legal entity identified as a building code scofflaw or problem landlord and the address of the building or buildings to which the pertinent code violations apply.

FILLING OUT THIS APPENDIX B CONSTITUTES ACKNOWLEDGMENT AND AGREEMENT THAT THIS APPENDIX B IS INCORPORATED BY REFERENCE INTO, AND MADE A PART OF, THE ASSOCIATED EDS, AND THAT THE REPRESENTATIONS MADE IN THIS APPENDIX B ARE SUBJECT TO THE CERTIFICATION MADE UNDER PENALTY OF PERJURY ON PAGE 12 OF THE ASSOCIATED EDS.

**CITY OF CHICAGO
ECONOMIC DISCLOSURE STATEMENT
AND AFFIDAVIT**

SECTION I -- GENERAL INFORMATION

A. Legal name of the Disclosing Party submitting this EDS. Include d/b/a/ if applicable:

Vequity Manager LLC

Check ONE of the following three boxes:

Indicate whether the Disclosing Party submitting this EDS is:

1. the Applicant

OR

2. a legal entity holding a direct or indirect interest in the Applicant. State the legal name of the Applicant in which the Disclosing Party holds an interest: _____

OR

3. a legal entity with a right of control (see Section II.B.1.) State the legal name of the entity in which the Disclosing Party holds a right of control: _____

B. Business address of the Disclosing Party: 400 N. State Street, Suite 400
Chicago, IL 60654

C. Telephone: 312-985-0974 Fax: _____ Email: c.ilekis@vequity.com

D. Name of contact person: Christopher Ilekis

E. Federal Employer Identification No. (if you have one): _____

F. Brief description of contract, transaction or other undertaking (referred to below as the "Matter") to which this EDS pertains. (Include project number and location of property, if applicable):

Map amendment for 1001 West Fulton Market

G. Which City agency or department is requesting this EDS? DPD

If the Matter is a contract being handled by the City's Department of Procurement Services, please complete the following:

Specification # _____ and Contract # _____

SECTION II -- DISCLOSURE OF OWNERSHIP INTERESTS

A. NATURE OF THE DISCLOSING PARTY

1. Indicate the nature of the Disclosing Party:

- | | |
|---|---|
| <input type="checkbox"/> Person | <input checked="" type="checkbox"/> Limited liability company |
| <input type="checkbox"/> Publicly registered business corporation | <input type="checkbox"/> Limited liability partnership |
| <input type="checkbox"/> Privately held business corporation | <input type="checkbox"/> Joint venture |
| <input type="checkbox"/> Sole proprietorship | <input type="checkbox"/> Not-for-profit corporation |
| <input type="checkbox"/> General partnership | (Is the not-for-profit corporation also a 501(c)(3))? |
| <input type="checkbox"/> Limited partnership | <input type="checkbox"/> Yes <input type="checkbox"/> No |
| <input type="checkbox"/> Trust | <input type="checkbox"/> Other (please specify) |

2. For legal entities, the state (or foreign country) of incorporation or organization, if applicable:

Illinois

3. For legal entities not organized in the State of Illinois: Has the organization registered to do business in the State of Illinois as a foreign entity?

- Yes No N/A

B. IF THE DISCLOSING PARTY IS A LEGAL ENTITY:

1. List below the full names and titles of all executive officers and all directors of the entity.

NOTE: For not-for-profit corporations, also list below all members, if any, which are legal entities. If there are no such members, write "no members." For trusts, estates or other similar entities, list below the legal titleholder(s).

If the entity is a general partnership, limited partnership, limited liability company, limited liability partnership or joint venture, list below the name and title of each general partner, managing member, manager or any other person or entity that controls the day-to-day management of the Disclosing Party. **NOTE:** Each legal entity listed below must submit an EDS on its own behalf.

Name	Title
<u>Chris Ilekis</u>	<u>Manager</u>
<u>Ryan Murphy</u>	<u>Manager</u>

2. Please provide the following information concerning each person or entity having a direct or indirect beneficial interest (including ownership) in excess of 7.5% of the Disclosing Party. Examples of such an interest include shares in a corporation, partnership interest in a partnership or joint venture,

interest of a member or manager in a limited liability company, or interest of a beneficiary of a trust, estate or other similar entity. If none, state "None." **NOTE:** Pursuant to Section 2-154-030 of the Municipal Code of Chicago ("Municipal Code"), the City may require any such additional information from any applicant which is reasonably intended to achieve full disclosure.

Name	Business Address	Percentage Interest in the Disclosing Party
Christopher Ilekis	400 N State Street, #400, Chicago, IL 60654	50%
Ryan Murphy	400 N State Street, #400, Chicago, IL 60654	50%

SECTION III -- BUSINESS RELATIONSHIPS WITH CITY ELECTED OFFICIALS

Has the Disclosing Party had a "business relationship," as defined in Chapter 2-156 of the Municipal Code, with any City elected official in the 12 months before the date this EDS is signed?

- Yes No

If yes, please identify below the name(s) of such City elected official(s) and describe such relationship(s):

SECTION IV -- DISCLOSURE OF SUBCONTRACTORS AND OTHER RETAINED PARTIES

The Disclosing Party must disclose the name and business address of each subcontractor, attorney, lobbyist, accountant, consultant and any other person or entity whom the Disclosing Party has retained or expects to retain in connection with the Matter, as well as the nature of the relationship, and the total amount of the fees paid or estimated to be paid. The Disclosing Party is not required to disclose employees who are paid solely through the Disclosing Party's regular payroll.

“Lobbyist” means any person or entity who undertakes to influence any legislative or administrative action on behalf of any person or entity other than: (1) a not-for-profit entity, on an unpaid basis, or (2) himself. “Lobbyist” also means any person or entity any part of whose duties as an employee of another includes undertaking to influence any legislative or administrative action.

If the Disclosing Party is uncertain whether a disclosure is required under this Section, the Disclosing Party must either ask the City whether disclosure is required or make the disclosure.

Name (indicate whether retained or anticipated to be retained)	Business Address	Relationship to Disclosing Party Fees (subcontractor, attorney, lobbyist, etc.)	(indicate whether paid or estimated.) NOTE: "hourly rate" or "t.b.d." is not an acceptable response.
--	------------------	---	---

(Add sheets if necessary)

Check here if the Disclosing Party has not retained, nor expects to retain, any such persons or entities.

SECTION V -- CERTIFICATIONS

A. COURT-ORDERED CHILD SUPPORT COMPLIANCE

Under Municipal Code Section 2-92-415, substantial owners of business entities that contract with the City must remain in compliance with their child support obligations throughout the contract's term.

Has any person who directly or indirectly owns 10% or more of the Disclosing Party been declared in arrearage on any child support obligations by any Illinois court of competent jurisdiction?

Yes No No person directly or indirectly owns 10% or more of the Disclosing Party.

If "Yes," has the person entered into a court-approved agreement for payment of all support owed and is the person in compliance with that agreement?

Yes No

B. FURTHER CERTIFICATIONS

1. Pursuant to Municipal Code Chapter 1-23, Article I ("Article I")(which the Applicant should consult for defined terms (e.g., "doing business") and legal requirements), if the Disclosing Party submitting this EDS is the Applicant and is doing business with the City, then the Disclosing Party certifies as follows: (i) neither the Applicant nor any controlling person is currently indicted or charged with, or has admitted guilt of, or has ever been convicted of, or placed under supervision for, any criminal offense involving actual, attempted, or conspiracy to commit bribery, theft, fraud, forgery, perjury, dishonesty or deceit against an officer or employee of the City or any sister agency; and (ii) the Applicant understands and acknowledges that compliance with Article I is a continuing requirement for doing business with the City. NOTE: If Article I applies to the Applicant, the permanent compliance timeframe in Article I supersedes some five-year compliance timeframes in certifications 2 and 3 below.

2. The Disclosing Party and, if the Disclosing Party is a legal entity, all of those persons or entities identified in Section II.B.1. of this EDS:

- a. are not presently debarred, suspended, proposed for debarment, declared ineligible or voluntarily excluded from any transactions by any federal, state or local unit of government;
- b. have not, within a five-year period preceding the date of this EDS, been convicted of a criminal offense, adjudged guilty, or had a civil judgment rendered against them in connection with: obtaining, attempting to obtain, or performing a public (federal, state or local) transaction or contract under a public transaction; a violation of federal or state antitrust statutes; fraud; embezzlement; theft; forgery; bribery; falsification or destruction of records; making false statements; or receiving stolen property;
- c. are not presently indicted for, or criminally or civilly charged by, a governmental entity (federal, state or local) with committing any of the offenses set forth in clause B.2.b. of this Section V;
- d. have not, within a five-year period preceding the date of this EDS, had one or more public transactions (federal, state or local) terminated for cause or default; and
- e. have not, within a five-year period preceding the date of this EDS, been convicted, adjudged guilty, or found liable in a civil proceeding, or in any criminal or civil action, including actions concerning environmental violations, instituted by the City or by the federal government, any state, or any other unit of local government.

3. The certifications in subparts 3, 4 and 5 concern:

- the Disclosing Party;
- any "Contractor" (meaning any contractor or subcontractor used by the Disclosing Party in connection with the Matter, including but not limited to all persons or legal entities disclosed under Section IV, "Disclosure of Subcontractors and Other Retained Parties");
- any "Affiliated Entity" (meaning a person or entity that, directly or indirectly: controls the Disclosing Party, is controlled by the Disclosing Party, or is, with the Disclosing Party, under common control of another person or entity. Indicia of control include, without limitation: interlocking management or ownership; identity of interests among family members, shared facilities and equipment; common use of employees; or organization of a business entity following the ineligibility of a business entity to do business with federal or state or local government, including the City, using substantially the same management, ownership, or principals as the ineligible entity); with respect to Contractors, the term Affiliated Entity means a person or entity that directly or indirectly controls the Contractor, is controlled by it, or, with the Contractor, is under common control of another person or entity;
- any responsible official of the Disclosing Party, any Contractor or any Affiliated Entity or any other official, agent or employee of the Disclosing Party, any Contractor or any Affiliated Entity, acting pursuant to the direction or authorization of a responsible official of the Disclosing Party, any Contractor or any Affiliated Entity (collectively "Agents").

Neither the Disclosing Party, nor any Contractor, nor any Affiliated Entity of either the Disclosing Party or any Contractor nor any Agents have, during the five years before the date this EDS is signed, or, with respect to a Contractor, an Affiliated Entity, or an Affiliated Entity of a Contractor during the five years before the date of such Contractor's or Affiliated Entity's contract or engagement in connection with the Matter:

- a. bribed or attempted to bribe, or been convicted or adjudged guilty of bribery or attempting to bribe, a public officer or employee of the City, the State of Illinois, or any agency of the federal government or of any state or local government in the United States of America, in that officer's or employee's official capacity;
- b. agreed or colluded with other bidders or prospective bidders, or been a party to any such agreement, or been convicted or adjudged guilty of agreement or collusion among bidders or prospective bidders, in restraint of freedom of competition by agreement to bid a fixed price or otherwise; or
- c. made an admission of such conduct described in a. or b. above that is a matter of record, but have not been prosecuted for such conduct; or
- d. violated the provisions of Municipal Code Section 2-92-610 (Living Wage Ordinance).

4. Neither the Disclosing Party, Affiliated Entity or Contractor, or any of their employees, officials, agents or partners, is barred from contracting with any unit of state or local government as a result of engaging in or being convicted of (1) bid-rigging in violation of 720 ILCS 5/33E-3; (2) bid-rotating in violation of 720 ILCS 5/33E-4; or (3) any similar offense of any state or of the United States of America that contains the same elements as the offense of bid-rigging or bid-rotating.

5. Neither the Disclosing Party nor any Affiliated Entity is listed on any of the following lists maintained by the Office of Foreign Assets Control of the U.S. Department of the Treasury or the Bureau of Industry and Security of the U.S. Department of Commerce or their successors: the Specially Designated Nationals List, the Denied Persons List, the Unverified List, the Entity List and the Debarred List.

6. The Disclosing Party understands and shall comply with the applicable requirements of Chapters 2-55 (Legislative Inspector General), 2-56 (Inspector General) and 2-156 (Governmental Ethics) of the Municipal Code.

7. If the Disclosing Party is unable to certify to any of the above statements in this Part B (Further Certifications), the Disclosing Party must explain below:

If the letters "NA," the word "None," or no response appears on the lines above, it will be conclusively presumed that the Disclosing Party certified to the above statements.

8. To the best of the Disclosing Party's knowledge after reasonable inquiry, the following is a complete list of all current employees of the Disclosing Party who were, at any time during the 12- month period preceding the execution date of this EDS, an employee, or elected or appointed official, of the City of Chicago (if none, indicate with "N/A" or "none").

N/A

9. To the best of the Disclosing Party's knowledge after reasonable inquiry, the following is a complete list of all gifts that the Disclosing Party has given or caused to be given, at any time during the 12-month period preceding the execution date of this EDS, to an employee, or elected or appointed official, of the City of Chicago. For purposes of this statement, a "gift" does not include: (i) anything made generally available to City employees or to the general public, or (ii) food or drink provided in the course of official City business and having a retail value of less than \$20 per recipient (if none, indicate with "N/A" or "none"). As to any gift listed below, please also list the name of the City recipient.

N/A

C. CERTIFICATION OF STATUS AS FINANCIAL INSTITUTION

1. The Disclosing Party certifies that the Disclosing Party (check one)

is

is not

a "financial institution" as defined in Section 2-32-455(b) of the Municipal Code.

2. If the Disclosing Party IS a financial institution, then the Disclosing Party pledges:

"We are not and will not become a predatory lender as defined in Chapter 2-32 of the Municipal Code. We further pledge that none of our affiliates is, and none of them will become, a predatory lender as defined in Chapter 2-32 of the Municipal Code. We understand that becoming a predatory lender or becoming an affiliate of a predatory lender may result in the loss of the privilege of doing business with the City."

If the Disclosing Party is unable to make this pledge because it or any of its affiliates (as defined in Section 2-32-455(b) of the Municipal Code) is a predatory lender within the meaning of Chapter 2-32 of the Municipal Code, explain here (attach additional pages if necessary):

If the letters "NA," the word "None," or no response appears on the lines above, it will be conclusively presumed that the Disclosing Party certified to the above statements.

D. CERTIFICATION REGARDING INTEREST IN CITY BUSINESS

Any words or terms that are defined in Chapter 2-156 of the Municipal Code have the same meanings when used in this Part D.

1. In accordance with Section 2-156-110 of the Municipal Code: Does any official or employee of the City have a financial interest in his or her own name or in the name of any other person or entity in the Matter?

Yes No

NOTE: If you checked "Yes" to Item D.1., proceed to Items D.2. and D.3. If you checked "No" to Item D.1., proceed to Part E.

2. Unless sold pursuant to a process of competitive bidding, or otherwise permitted, no City elected official or employee shall have a financial interest in his or her own name or in the name of any other person or entity in the purchase of any property that (i) belongs to the City, or (ii) is sold for taxes or assessments, or (iii) is sold by virtue of legal process at the suit of the City (collectively, "City Property Sale"). Compensation for property taken pursuant to the City's eminent domain power does not constitute a financial interest within the meaning of this Part D.

Does the Matter involve a City Property Sale?

Yes No

3. If you checked "Yes" to Item D.1., provide the names and business addresses of the City officials or employees having such interest and identify the nature of such interest:

Name	Business Address	Nature of Interest
_____	_____	_____
_____	_____	_____

4. The Disclosing Party further certifies that no prohibited financial interest in the Matter will be acquired by any City official or employee.

E. CERTIFICATION REGARDING SLAVERY ERA BUSINESS

Please check either 1. or 2. below. If the Disclosing Party checks 2., the Disclosing Party must disclose below or in an attachment to this EDS all information required by paragraph 2. Failure to

comply with these disclosure requirements may make any contract entered into with the City in connection with the Matter voidable by the City.

 X 1. The Disclosing Party verifies that the Disclosing Party has searched any and all records of the Disclosing Party and any and all predecessor entities regarding records of investments or profits from slavery or slaveholder insurance policies during the slavery era (including insurance policies issued to slaveholders that provided coverage for damage to or injury or death of their slaves), and the Disclosing Party has found no such records.

 2. The Disclosing Party verifies that, as a result of conducting the search in step 1 above, the Disclosing Party has found records of investments or profits from slavery or slaveholder insurance policies. The Disclosing Party verifies that the following constitutes full disclosure of all such records, including the names of any and all slaves or slaveholders described in those records:

SECTION VI -- CERTIFICATIONS FOR FEDERALLY FUNDED MATTERS

NOTE: If the Matter is federally funded, complete this Section VI. If the Matter is not federally funded, proceed to Section VII. For purposes of this Section VI, tax credits allocated by the City and proceeds of debt obligations of the City are not federal funding.

A. CERTIFICATION REGARDING LOBBYING

1. List below the names of all persons or entities registered under the federal Lobbying Disclosure Act of 1995 who have made lobbying contacts on behalf of the Disclosing Party with respect to the Matter: (Add sheets if necessary):

(If no explanation appears or begins on the lines above, or if the letters "NA" or if the word "None" appear, it will be conclusively presumed that the Disclosing Party means that NO persons or entities registered under the Lobbying Disclosure Act of 1995 have made lobbying contacts on behalf of the Disclosing Party with respect to the Matter.)

2. The Disclosing Party has not spent and will not expend any federally appropriated funds to pay any person or entity listed in Paragraph A.1. above for his or her lobbying activities or to pay any person or entity to influence or attempt to influence an officer or employee of any agency, as defined by applicable federal law, a member of Congress, an officer or employee of Congress, or an employee of a member of Congress, in connection with the award of any federally funded contract, making any federally funded grant or loan, entering into any cooperative agreement, or to extend, continue, renew, amend, or modify any federally funded contract, grant, loan, or cooperative agreement.

3. The Disclosing Party will submit an updated certification at the end of each calendar quarter in which there occurs any event that materially affects the accuracy of the statements and information set forth in paragraphs A.1. and A.2. above.

4. The Disclosing Party certifies that either: (i) it is not an organization described in section 501(c)(4) of the Internal Revenue Code of 1986; or (ii) it is an organization described in section 501(c)(4) of the Internal Revenue Code of 1986 but has not engaged and will not engage in "Lobbying Activities".

5. If the Disclosing Party is the Applicant, the Disclosing Party must obtain certifications equal in form and substance to paragraphs A.1. through A.4. above from all subcontractors before it awards any subcontract and the Disclosing Party must maintain all such subcontractors' certifications for the duration of the Matter and must make such certifications promptly available to the City upon request.

B. CERTIFICATION REGARDING EQUAL EMPLOYMENT OPPORTUNITY

If the Matter is federally funded, federal regulations require the Applicant and all proposed subcontractors to submit the following information with their bids or in writing at the outset of negotiations.

Is the Disclosing Party the Applicant?

Yes

No

If "Yes," answer the three questions below:

1. Have you developed and do you have on file affirmative action programs pursuant to applicable federal regulations? (See 41 CFR Part 60-2.)

Yes

No

2. Have you filed with the Joint Reporting Committee, the Director of the Office of Federal Contract Compliance Programs, or the Equal Employment Opportunity Commission all reports due under the applicable filing requirements?

Yes

No

3. Have you participated in any previous contracts or subcontracts subject to the equal opportunity clause?

Yes

No

If you checked "No" to question 1. or 2. above, please provide an explanation:

SECTION VII -- ACKNOWLEDGMENTS, CONTRACT INCORPORATION, COMPLIANCE, PENALTIES, DISCLOSURE

The Disclosing Party understands and agrees that:

A. The certifications, disclosures, and acknowledgments contained in this EDS will become part of any contract or other agreement between the Applicant and the City in connection with the Matter, whether procurement, City assistance, or other City action, and are material inducements to the City's execution of any contract or taking other action with respect to the Matter. The Disclosing Party understands that it must comply with all statutes, ordinances, and regulations on which this EDS is based.

B. The City's Governmental Ethics and Campaign Financing Ordinances, Chapters 2-156 and 2-164 of the Municipal Code, impose certain duties and obligations on persons or entities seeking City contracts, work, business, or transactions. The full text of these ordinances and a training program is available on line at www.cityofchicago.org/Ethics, and may also be obtained from the City's Board of Ethics, 740 N.

Sedgwick St., Suite 500, Chicago, IL 60610, (312) 744-9660. The Disclosing Party must comply fully with the applicable ordinances.

C. If the City determines that any information provided in this EDS is false, incomplete or inaccurate, any contract or other agreement in connection with which it is submitted may be rescinded or be void or voidable, and the City may pursue any remedies under the contract or agreement (if not rescinded or void), at law, or in equity, including terminating the Disclosing Party's participation in the Matter and/or declining to allow the Disclosing Party to participate in other transactions with the City. Remedies at law for a false statement of material fact may include incarceration and an award to the City of treble damages.

D. It is the City's policy to make this document available to the public on its Internet site and/or upon request. Some or all of the information provided on this EDS and any attachments to this EDS may be made available to the public on the Internet, in response to a Freedom of Information Act request, or otherwise. By completing and signing this EDS, the Disclosing Party waives and releases any possible rights or claims which it may have against the City in connection with the public release of information contained in this EDS and also authorizes the City to verify the accuracy of any information submitted in this EDS.

E. The information provided in this EDS must be kept current. In the event of changes, the Disclosing Party must supplement this EDS up to the time the City takes action on the Matter. If the Matter is a contract being handled by the City's Department of Procurement Services, the Disclosing Party must update this EDS as the contract requires. **NOTE:** With respect to Matters subject to Article I of Chapter 1-23 of the Municipal Code (imposing **PERMANENT INELIGIBILITY** for certain specified offenses), the information provided herein regarding eligibility must be kept current for a longer period, as required by Chapter 1-23 and Section 2-154-020 of the Municipal Code.

The Disclosing Party represents and warrants that:

F.1. The Disclosing Party is not delinquent in the payment of any tax administered by the Illinois Department of Revenue, nor are the Disclosing Party or its Affiliated Entities delinquent in paying any fine, fee, tax or other charge owed to the City. This includes, but is not limited to, all water charges, sewer charges, license fees, parking tickets, property taxes or sales taxes.

F.2 If the Disclosing Party is the Applicant, the Disclosing Party and its Affiliated Entities will not use, nor permit their subcontractors to use, any facility listed by the U.S. E.P.A. on the federal Excluded Parties List System ("EPLS") maintained by the U. S. General Services Administration.

F.3 If the Disclosing Party is the Applicant, the Disclosing Party will obtain from any contractors/subcontractors hired or to be hired in connection with the Matter certifications equal in form and substance to those in F.1. and F.2. above and will not, without the prior written consent of the City, use any such contractor/subcontractor that does not provide such certifications or that the Disclosing Party has reason to believe has not provided or cannot provide truthful certifications.

NOTE: If the Disclosing Party cannot certify as to any of the items in F.1., F.2. or F.3. above, an explanatory statement must be attached to this EDS.

CERTIFICATION

Under penalty of perjury, the person signing below: (1) warrants that he/she is authorized to execute this EDS and Appendix A (if applicable) on behalf of the Disclosing Party, and (2) warrants that all certifications and statements contained in this EDS and Appendix A (if applicable) are true, accurate and complete as of the date furnished to the City.

Vequity Manager, LLC +
(Print or type name of Disclosing Party)

By: 
(Sign here)

Christopher Ilekis
(Print or type name of person signing)

Manager
(Print or type title of person signing)

Signed and sworn to before me on (date) May 11, 2017,
at COOK County, IL (state).

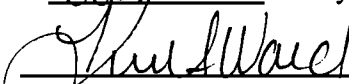
 Notary Public.

Commission expires: 2/10/19

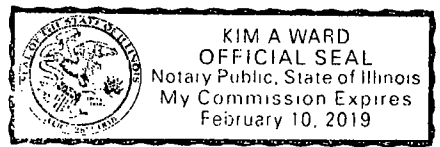

**CITY OF CHICAGO
ECONOMIC DISCLOSURE STATEMENT AND AFFIDAVIT
APPENDIX A**

FAMILIAL RELATIONSHIPS WITH ELECTED CITY OFFICIALS AND DEPARTMENT HEADS

This Appendix is to be completed only by (a) the Applicant, and (b) any legal entity which has a direct ownership interest in the Applicant exceeding 7.5 percent. It is not to be completed by any legal entity which has only an indirect ownership interest in the Applicant.

Under Municipal Code Section 2-154-015, the Disclosing Party must disclose whether such Disclosing Party or any “Applicable Party” or any Spouse or Domestic Partner thereof currently has a “familial relationship” with any elected city official or department head. A “familial relationship” exists if, as of the date this EDS is signed, the Disclosing Party or any “Applicable Party” or any Spouse or Domestic Partner thereof is related to the mayor, any alderman, the city clerk, the city treasurer or any city department head as spouse or domestic partner or as any of the following, whether by blood or adoption: parent, child, brother or sister, aunt or uncle, niece or nephew, grandparent, grandchild, father-in-law, mother-in-law, son-in-law, daughter-in-law, stepfather or stepmother, stepson or stepdaughter, stepbrother or stepsister or half-brother or half-sister.

“Applicable Party” means (1) all executive officers of the Disclosing Party listed in Section II.B.1.a., if the Disclosing Party is a corporation; all partners of the Disclosing Party, if the Disclosing Party is a general partnership; all general partners and limited partners of the Disclosing Party, if the Disclosing Party is a limited partnership; all managers, managing members and members of the Disclosing Party, if the Disclosing Party is a limited liability company; (2) all principal officers of the Disclosing Party; and (3) any person having more than a 7.5 percent ownership interest in the Disclosing Party. “Principal officers” means the president, chief operating officer, executive director, chief financial officer, treasurer or secretary of a legal entity or any person exercising similar authority.

Does the Disclosing Party or any “Applicable Party” or any Spouse or Domestic Partner thereof currently have a “familial relationship” with an elected city official or department head?

Yes

No

If yes, please identify below (1) the name and title of such person, (2) the name of the legal entity to which such person is connected; (3) the name and title of the elected city official or department head to whom such person has a familial relationship, and (4) the precise nature of such familial relationship.

**CITY OF CHICAGO
ECONOMIC DISCLOSURE STATEMENT AND AFFIDAVIT
APPENDIX B**

BUILDING CODE SCOFFLAW/PROBLEM LANDLORD CERTIFICATION

This Appendix is to be completed only by (a) the Applicant, and (b) any legal entity which has a direct ownership interest in the Applicant exceeding 7.5 percent (an "Owner"). It is not to be completed by any legal entity which has only an indirect ownership interest in the Applicant.

1. Pursuant to Municipal Code Section 2-154-010, is the Applicant or any Owner identified as a building code scofflaw or problem landlord pursuant to Section 2-92-416 of the Municipal Code?

Yes

No

2. If the Applicant is a legal entity publicly traded on any exchange, is any officer or director of the Applicant identified as a building code scofflaw or problem landlord pursuant to Section 2-92-416 of the Municipal Code?

Yes

No

Not Applicable

3. If yes to (1) or (2) above, please identify below the name of the person or legal entity identified as a building code scofflaw or problem landlord and the address of the building or buildings to which the pertinent code violations apply.

FILLING OUT THIS APPENDIX B CONSTITUTES ACKNOWLEDGMENT AND AGREEMENT THAT THIS APPENDIX B IS INCORPORATED BY REFERENCE INTO, AND MADE A PART OF, THE ASSOCIATED EDS, AND THAT THE REPRESENTATIONS MADE IN THIS APPENDIX B ARE SUBJECT TO THE CERTIFICATION MADE UNDER PENALTY OF PERJURY ON PAGE 12 OF THE ASSOCIATED EDS.