



City of Chicago



O2017-3468

Office of the City Clerk

Document Tracking Sheet

Meeting Date:	4/19/2017
Sponsor(s):	Brookins (21)
Type:	Ordinance
Title:	Grant(s) of privilege in public way for New Pisgah Day Care
Committee(s) Assignment:	Committee on Transportation and Public Way

ORDINANCE
NEW PISGAH DAY CARE
Acct. No. 25201 - 1
Permit No. 1127488

Be It Ordained by the City Council of the City of Chicago:

SECTION 1. Permission and authority are hereby given and granted to NEW PISGAH DAY CARE, upon the terms and subject to the conditions of this ordinance to maintain and use one (1) sign(s) projecting over the public right-of-way attached to its premises known as 8130 S. Racine Ave..

Said sign structure(s) measures as follows; along S. Racine:

One (1) at four (4) feet in length, five (5) feet in height and fourteen (14) feet above grade level.

The location of said privilege shall be as shown on prints kept on file with the Department of Business Affairs and Consumer Protection and the Office of the City Clerk.

Said privilege shall be constructed in accordance with plans and specifications approved by the Department of Transportation (Division of Project Development) and Zoning Department - Signs.

This grant of privilege in the public way shall be subject to the provisions of Section 10-28-015 and all other required provisions of the Municipal Code of Chicago.

The grantee shall pay to the City of Chicago as compensation for the privilege #1127488 herein granted the sum of one hundred (\$100.00) per annum in advance.

A 25% penalty will be added for payments received after due date.

The permit holder agrees to hold the City of Chicago harmless for any damage, relocation or replacement costs associated with damage, relocation or removal of private property caused by the City performing work in the public way.

Authority herein given and granted for a period of five (5) years from and after 04/11/2017.

Alderman

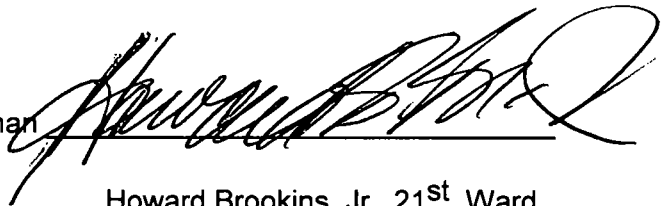

Howard Brookins, Jr. 21st Ward

1

2

3

4

5

6

P10 LED display

Size 90.55in×33.86in×6in

Resolution 224×80pixel

Input 100 120VAC 50/60Hz

Rated current 1.2Kw

Average Power consumption 0.4Kw

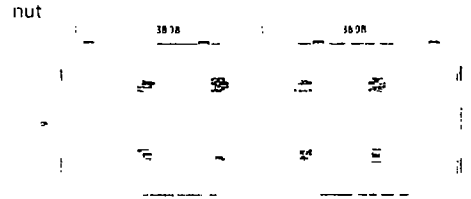
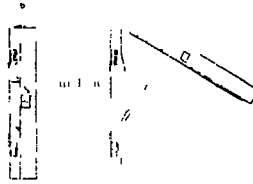
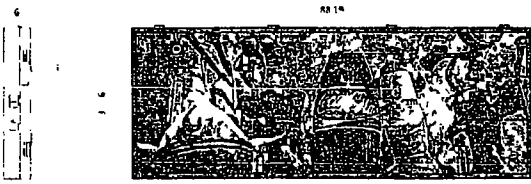
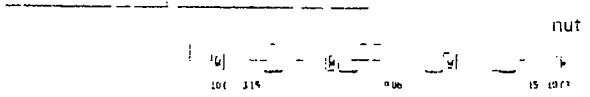

New Pisgah MB Church and Daycare
 8130 S Racine
 Chicago, IL 60620

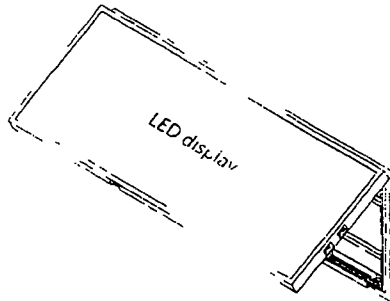
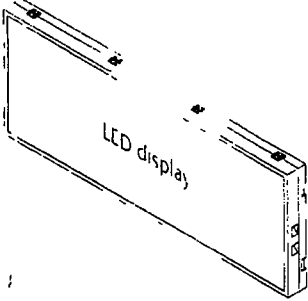

1

2

3

4

5

6

**ATTRACTIVE
SIGN & LIGHTING**
 443 West US Hwy 6
 Valparaiso IN 46385
 312 718 8819



Department of Business Affairs and Consumer Protection
Small Business Center - Public Way Use Unit
City Hall - 121 N. LaSalle Street, Room 800 • Chicago, IL 60602
312-74-GOBIZ / 312-744-6249 • (312) 744-1944 (TTY)
<http://www.cityofchicago.org/bacp>

04/19/2017

Alderman Howard Brookins, Jr.
Ward # **21**
City of Chicago
City Hall, Room **300**
121 North LaSalle Street
Chicago, Illinois 60602

Re: An ordinance to use and maintain a portion of the public right-of-way for **one (1) sign(s)** for **NEW PISGAH DAY CARE**, adjacent to the premises known as **8130 S. Racine Ave.**.

Dear Alderman **Howard Brookins, Jr.**:

The applicant referenced above has requested the use of the public right-of-way for a **sign(s)**. An ordinance has been prepared by the Department of Business Affairs and Consumer Protection – Small Business Center - Public Way Use Unit for presentation to the City Council. Because this request was made for properties located in your ward, as approved by you as per the attached, I respectfully request that you introduce the attached ordinance at the next City Council meeting.

If you have any questions regarding this ordinance, please contact Anthony Bertuca at (312) 744-5506.

Department of Business Affairs and Consumer Protection