



City of Chicago



O2016-8830

Office of the City Clerk

Document Tracking Sheet

Meeting Date:	12/14/2016
Sponsor(s):	Hopkins (2)
Type:	Ordinance
Title:	Awning(s) for Sushi Para M
Committee(s) Assignment:	Committee on Transportation and Public Way

ORDINANCE
SUSHI PARA M
Acct. No. 352028 - 1
Permit No. 1125320

Be It Ordained by the City Council of the City of Chicago:

SECTION 1. Permission and authority are hereby given and granted to SUSHI PARA M, upon the terms and subject to the conditions of this ordinance to maintain and use, as now constructed, one (1) Awning(s) projecting over the public right-of-way adjacent to its premises known as 1633 N. Milwaukee Ave..

Said Awning(s) at N. MILWAUKEE AVENUE measure(s):

One (1) at twenty-four (24) feet in length, and two (2) feet in width for a total of forty-eight (48) square feet.

The location of said privilege shall be as shown on prints kept on file with the Department of Business Affairs and Consumer Protection and the Office of the City Clerk.

Said privilege shall be constructed in accordance with plans and specifications approved by the Zoning Department - Signs.

This grant of privilege in the public way shall be subject to the provisions of Section 10-28-015 and all other required provisions of the Municipal Code of Chicago.

The grantee shall pay to the City of Chicago as compensation for the privilege #1125320 herein granted the sum of fifty (\$50.00) per annum in advance.

A 25% penalty will be added for payments received after due date.

The permit holder agrees to hold the City of Chicago harmless for any damage, relocation or replacement costs associated with damage, relocation or removal of private property caused by the City performing work in the public way.

Authority herein given and granted for a period of five (5) years from and after 12/14/2016.

Alderman _____

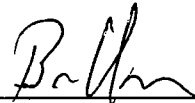

Brian Hopkins 2nd Ward

RECEIVED 01/18/2015 11:18AM
TO +13123328810

FROM 3129405918
12/2/2016 8:37 AM

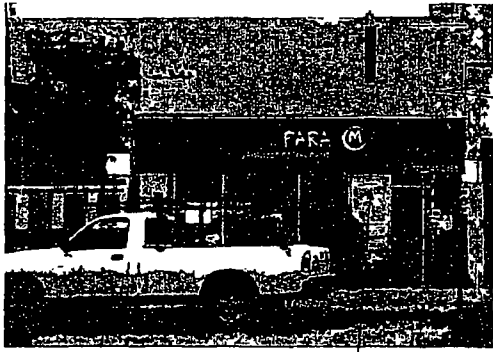

1) Double Sided Light Box

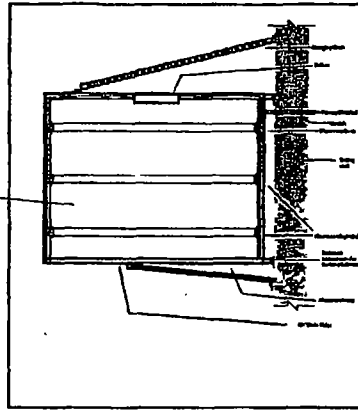
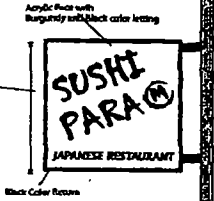

2) Awing

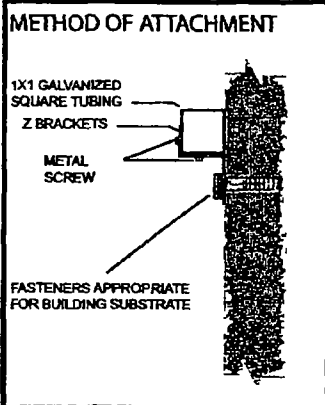
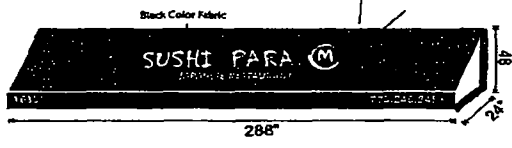

SIGNATURE

LANDLORD

Phone

TENANT

DATE

Site Address:	1633 N Milwaukee Ave Chicago
Sign Type:	Double Sided Light Box & Awning

Client: Sushi Para		Drawing #:		All sign designs and concepts shown here are confidential and are the property of Monstah, Inc. They are not to be distributed, exhibited, copied or otherwise used without our written permission. COMPUTER GENERATED COLORS ARE NOT A TRUE MATCH TO ANY TYPE OF VINYL OR PAINT  3401 S. Halsted St., Chicago, IL TEL. 773-847-2828 Fax: 773-847-0088
approved	Sales:	Date:	02-18-10	
scale 1" = 32"	Drawn by:	Rev Date:		



12/14/2016

Alderman Brian Hopkins
Ward # 02
City of Chicago
City Hall, Room 200
121 North LaSalle Street
Chicago, Illinois 60602

Re: An ordinance to use and maintain a portion of the public right-of-way for **one (1) awning(s)** for **SUSHI PARA M**, adjacent to the premises known as **1633 N. Milwaukee Ave.**

Dear Alderman **Brian Hopkins**:

The applicant referenced above has requested the use of the public right-of-way for a **awning(s)**. An ordinance has been prepared by the Department of Business Affairs and Consumer Protection – Small Business Center - Public Way Use Unit for presentation to the City Council. Because this request was made for properties located in your ward, as approved by you as per the attached, I respectfully request that you introduce the attached ordinance at the next City Council meeting.

If you have any questions regarding this ordinance, please contact Anthony Bertuca at (312) 744-5506.

Department of Business Affairs and Consumer Protection