



City of Chicago



Or2019-95

Office of the City Clerk

Document Tracking Sheet

Meeting Date:	3/13/2019
Sponsor(s):	Scott, Jr. (24)
Type:	Order
Title:	Issuance of permits for sign(s)/signboard(s) at 3745 W Ogden Ave - east elevation
Committee(s) Assignment:	Committee on Zoning, Landmarks and Building Standards

CITY COUNCIL
COMMITTEE ON ZONING, LANDMARKS AND BUILDING STANDARDS

COUNCIL ORDER

RE: Approval of sign over 100 square feet in area or over 24 feet above grade

ORDERED, that the City Council hereby approves the following sign application submitted by:

Applicant*: Joseph Lesch (Lawndale Christian Health Center)

(* The Applicant is the owner of the real property or the business tenant of the real property. Do not list the sign contractor, sign erector, sign company or advertising entity in the above space.)

This Order approves the following sign in accordance with Municipal Code of Chicago Section 13-20-680:

Address of Sign: 3745 W. Ogden Ave Chicago, IL 606 23

Zoning District: C1-2

DOB Sign Permit Application #: 100800336

Sign Details:

1. On-premise X OR Off-premise _____

2. Static sign X OR Dynamic-Image display sign _____

3. Number of sign faces 1

4. Projecting over the public way N (Yes or No) If yes, Public Way Use #: 1138217

5. Dimensions: Length 3 feet 6 inches Height 3 feet 6 inches

Total square feet in area: 12 feet 3 inches

6. Height above grade: 23 feet 0 inches 26 ft 6 in to top

7. Elevation (side of building or lot where the sign will be erected): East

8. Name of Sign Contractor/Erector: Comet Neon, Inc.

To be legal, such sign shall comply with all provisions of Title 17 of the Chicago Municipal Code ("Zoning Ordinance") and all other provisions of the Municipal Code governing the permitting, construction and maintenance and removal of signs and sign structures. Failure of the applicant and the applicant's successors to comply shall be grounds for invalidation or revocation of the sign permit.

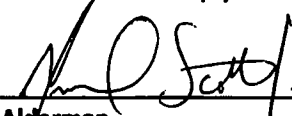
Alderman

24
Ward

PUBLIC WAY USE UNIT: PERMIT INFORMATION SHEET

02/06/2019 - Sunny Choi

DBA Name LAWNDALE CHRISTIAN HEALTH CENTER

Location 3745 W. OGDEN AVE.

Zip Code 60623

Account Number 30191

Site Number 7

Area PERMIT

Permit Type SIGN

Permit Number - 1138217 -

Next steps: Department of Buildings – Permit process for signs

Your Public Way Use permit number is shown above. This number is to be used for each item on your DOB application and is needed for the Buildings (DOB) online sign application located @ www.cityofchicago.org/buildings. All signs, canopies, banners, marquees and awnings require a buildings permit. Only a licensed sign erector may apply for the Buildings permit online. The Buildings permit application will ask for the Public Way Use permit number supplied above. For additional information please contact the Buildings Department at (312) 744-3400.

Please return the completed Public Way Use application to City Hall - 121 N. LaSalle Street, Chicago, IL 60602 Room 800. The completed application package must include a copy of the completed DOB application and the Public Way Use application. The Public Way Use application must contain the Alderman's signature, site plans on 8 1/2 X 11 paper, photos of the item(s), the signed Acceptance letter and a copy of the insurance certificate. For additional information please contact BACP at 312-74-GOBIZ / 312-744-6249.

FLUSH-MOUNT, INTERNALLY-ILLUMINATED LOGOS

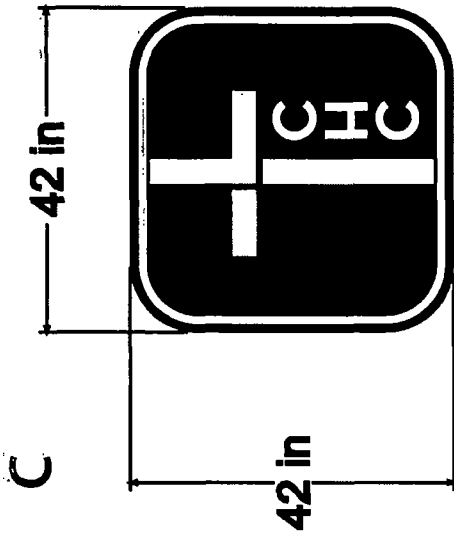

- "CHC" Logo:
 - 5" D Metallic Silver Returns
 - 3/16" White Acrylic Face
 - w/ 3M 3630-137 European Blue Vinyl
 - Fabricated Aluminum Trim
 - painted PMS 2955 Blue

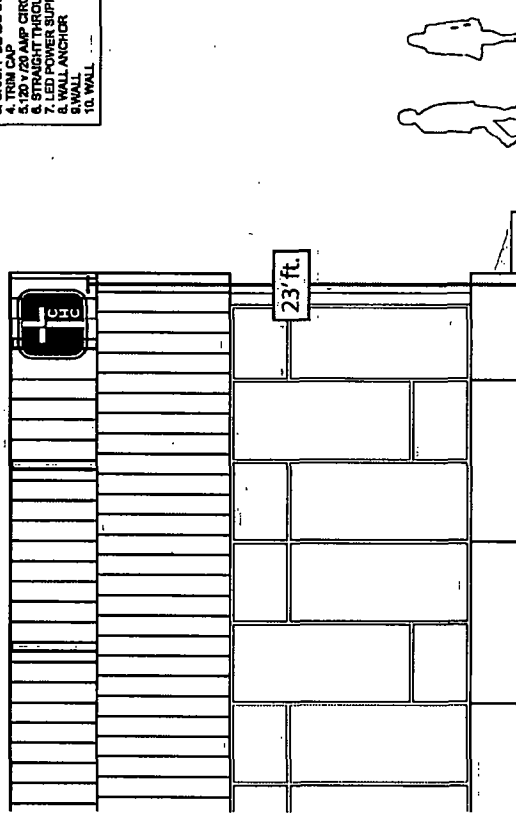
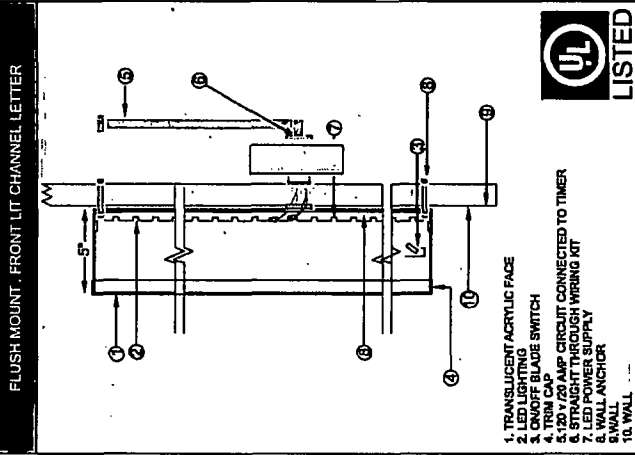

1120 N. Ridge Ave.
 Lombard, IL 60148
 Phone: (630) 656-1085
 Fax: (630) 656-1088
 permits@cometneon.com
 www.cometneon.com



Client Name: Lawndale Christian
 Health Center
 Location: 3745 W. Ogden Ave.
 Chicago, IL

Start Date: 12/11/18
 Drawn By: Marcin Wolak
 Job#: N/A
 Drawing#: N/A
 Page: 3 of 6

Client Approval
 Landlord Approval

PROPOSED SIGNAGE

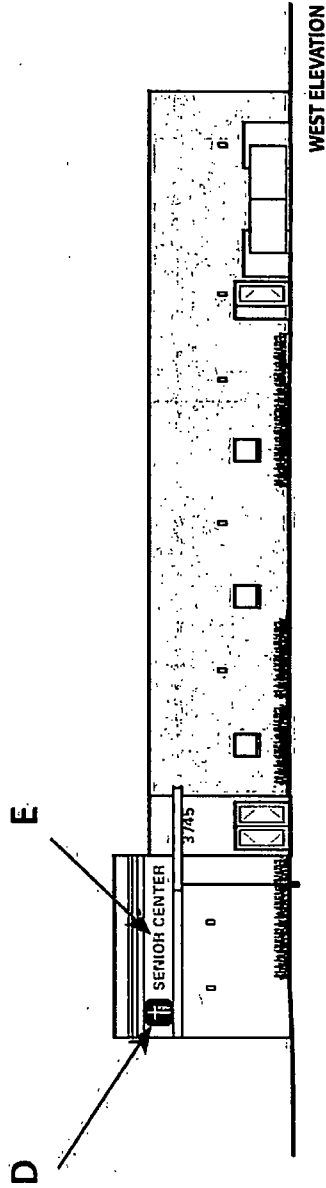
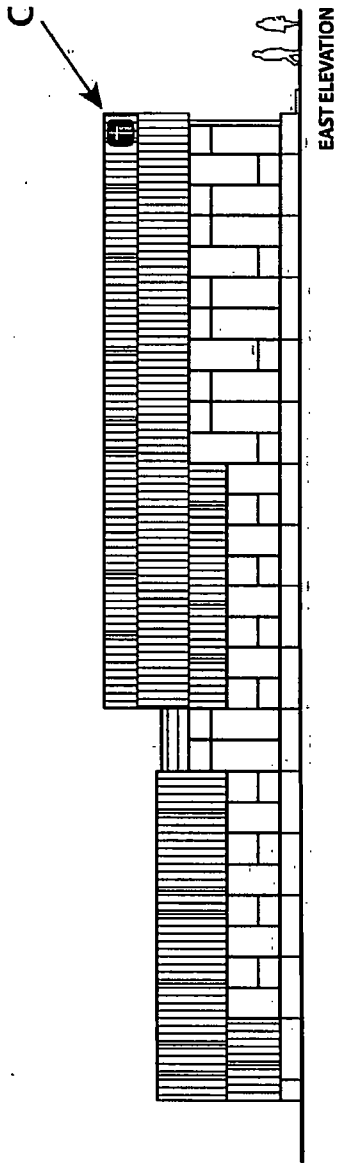
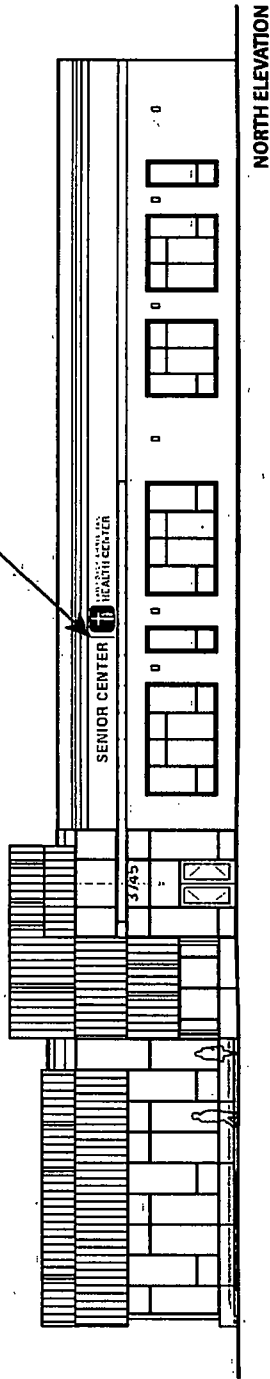

1120 N. Ridge Ave.
Lombard, IL 60148
Phone: (630) 656-1085
Fax: (630) 656-1088
permits@cometneon.com
www.cometneon.com

COMETNEON
SIGN AND AWNING

Client Name: Lawndale Christian Health Center
Location: 3745 W. Ogden Ave. Chicago, IL

Start Date: 12/11/18
Drawn By: Marcin Wolak
Job#: N/A
Drawing#: N/A
Page: 6 of 6

..... Client Approval
..... Landlord Approval

SEE DRAWING
LABELED PAGE 6 OF 6,
EAST ELEVATION

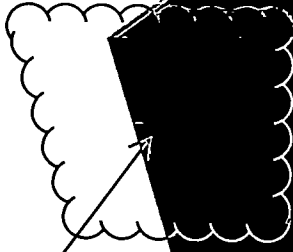

02.05.2019



SEE DRAWING
LABELED PAGE 6 OF 6,
NORTH ELEVATION

02.05.2019

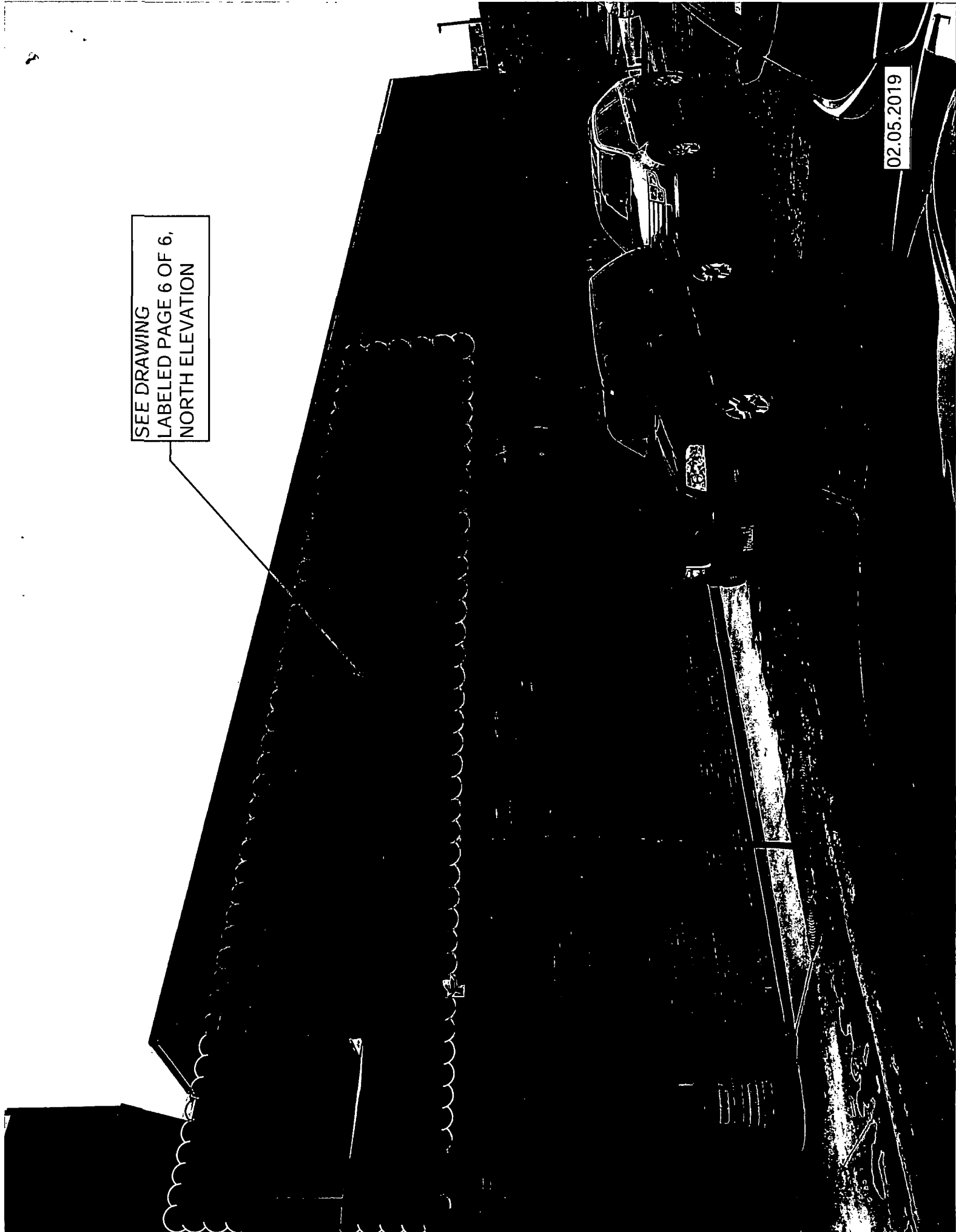

SEE DRAWING
LABELED PAGE 6 OF 6,
WEST ELEVATION

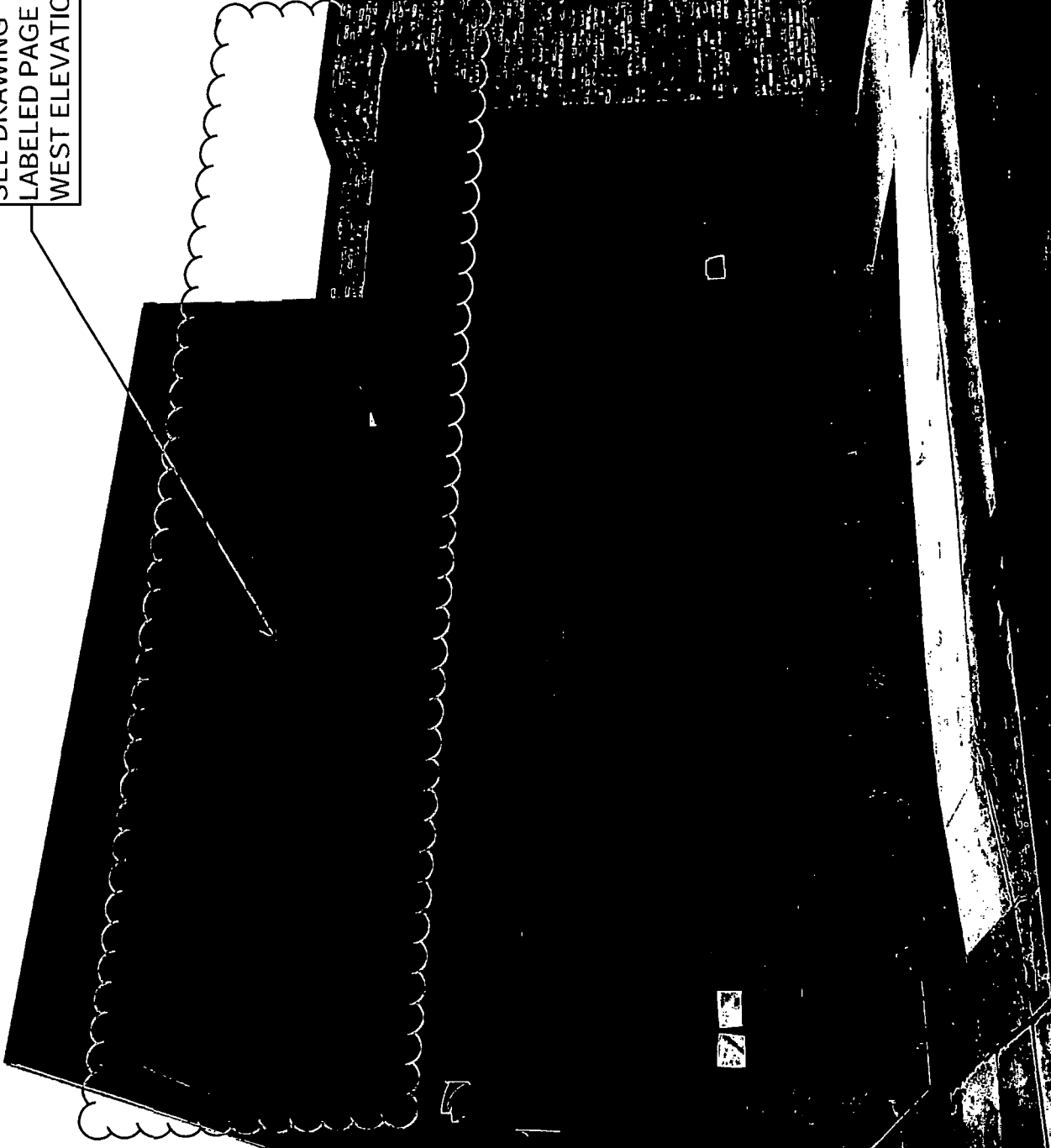

02.05.2019