



Mayor

Very truly yours,

ORDINANCE

WHEREAS, the Chicago Department of Transportation ('CDOT') and the Department of Innovation and Technology (DoIT⁷) (collectively, the "Departments") wish to retain a vendor for the purpose of implementing the comprehensive Chicago Smart Lighting Project (Project⁷); and

WHEREAS, the Project is intended to improve the quality and reliability of Chicago's outdoor lighting and thereby enhance public safety and quality of life for Chicago's residents and visitors; and

WHEREAS, the Project consists of three primary elements that will be deployed City-wide over the next four years: (i) a large scale conversion of Chicago's existing outdoor lighting to LED technology, (ii) the deployment of a City-wide lighting management system, and (iii) targeted street lighting infrastructure stabilization repairs; and

WHEREAS, the Project's LED lighting conversion is anticipated to reduce street lighting electric consumption by over 50%, ultimately resulting in utility savings of over \$10 million per year over the useful life of the products; and

WHEREAS, the Project's lighting management system investment creates a wireless network with the ability to transmit data ancillary to this Project for other beneficial City purposes; and

WHEREAS, the Chicago Infrastructure Trust (CIT¹), on behalf of the City of Chicago (City), led the Project procurement in coordination with the City and the Departments; and

WHEREAS, the CIT issued a Request for Qualifications on April 18, 2016 and an evaluation committee, comprised of CIT, City, and Chicago Park District ('Parks') representatives reviewed the credentials, experience, and capacity of thirty teams of companies and selected nine entities as Shortlisted Proposers; and

WHEREAS, the CIT issued a Request for Proposals on November 2, 2016, and an evaluation committee, comprised of CIT, City, and Parks representatives, and assisted by technical subject matter experts, reviewed and analyzed six proposals and recommended Ameresco, Inc. ('Ameresco') as the best value proposer to the CIT Board of Directors (CIT Board¹); and

WHEREAS, the CIT Board of Directors voted unanimously to recommend the City begin negotiations with Ameresco; and

WHEREAS, the Departments and Ameresco have agreed to the terms for the Project, which are reflected in the Project agreement which is attached hereto as Exhibit A ('Project Agreement'); and

WHEREAS, the Project Agreement authorizes the Commissioners to issue work orders, subject to appropriation of funds, for the LED conversion and infrastructure stabilization repair portions of the Project; and

WHEREAS, the Project Agreement includes a base technology scope of work and also authorizes the Commissioners to enter into task orders, subject to appropriation of funds, for the commissioning of additional hardware or technology services; and

WHEREAS, the Departments wish for the City Council to authorize the Commissioners of CDOT and DoIT to finalize and enter into such Project Agreement.

NOW THEREFORE, it is ordained by the City Council of the City as follows:

1. The recitals are incorporated herein.
2. The Commissioners of CDOT and DoIT are authorized to finalize and enter into a Project Agreement with Ameresco, in substantially the form attached hereto as Exhibit A, with such other terms as determined by the Commissioners, provided that they are favorable to the City, and; subject to approval of the corporation counsel as to form and legality and also subject to the availability of duly appropriated funds, to execute such Project Agreement amendments, change orders, or term extensions as may be necessary or appropriate.
3. The Commissioners of CDOT and DoIT are authorized to enter into intergovernmental agreement(s) with Parks to the extent determined to be desirable by the Commissioners to facilitate the integration of Parks outdoor lighting into the lighting management system, which shall be subject to approval of the corporation counsel as to form and legality and also subject to the availability of duly appropriated funds.
4. The Commissioners of CDOT and DoIT are authorized to enter into agreements with the technology subcontractor in the Project Agreement, Silver Spring Networks, or its successors, to provide services or work, paid for by the City, to facilitate expansion or new uses of the lighting management system network for beneficial City purposes. Such agreements shall be subject to approval of the corporation counsel as to form and legality and also subject to the availability of duly appropriated funds.

This ordinance is effective upon its passage and approval.

Exhibit A Project Agreement

Vendor No.:

Spec. No.:

P.O. No.:

City Funded

AGREEMENT FOR CHICAGO SMART LIGHTING PROJECT



BETWEEN

**THE CITY OF CHICAGO DEPARTMENT OF
TRANSPORTATION AND
DEPARTMENT OF INNOVATION AND TECHNOLOGY**

AND

AMERESCO, INC.

Table of Contents

ARTICLE 1. INTRODUCTION

5

ARTICLE 2. INCORPORATION OF EXHIBITS:	5	
ARTICLE 3. GENERAL TERMS AND CONDITIONS	6	
3.1. General Provisions		6
1. Definitions	6	
2. Interpretation of Contract	8	
3. Subcontracting and Assignment	9	
4. Contract Governance	10	
5. Confidentiality	13	
6. Indemnity	14	
7. Non-Liability of Public Officials	15	
8. Force Majeure	15	
3.2. Compensation Provisions		15
1. Contract Price	15	
2. Procedure for Monthly Payment Requests and Final Payment	16	
3. Payment for Stored Material	18	
4. Retainage	19	
5. Payments Withheld	19	
6. Payment for Changes	20	
7. Night, Sunday and Holiday Work	25	
8. Acceleration	25	
9. Liquidated Damages	26	
10. Ordering, Invoices, and Payment for Non-Construction Portions of the Project	26	
11. Electronic Ordering and Invoices	27	
12. City Right to Offset	27	
13. Records	27	
14. Audits	28	
15. Subcontractor Payment Reports	28	
16. Prompt Payment to Subcontractors	28	
17. General Price Reduction - Automatic Eligibility for General Price Reductions	30	
3.3. Compliance With All Laws		31
1. General	31	
2. Certification of Compliance with Laws	31	
3. Federal Affirmative Action	31	
4. Civil Rights Act of 1964, Title VI, Compliance With Nondiscrimination Requirements	31	
5. Other Non-Discrimination Requirements	33	
6. Wages	34	
7. Economic Disclosure Statement and Affidavit and Appendix A ("EDS")	37	
8. EDS Update Obligation	38	
9. Restrictions on Business Dealings	39	
10. Debts Owed to the City; Anti-Scofflaw, MCC Sect. 2-92-380	40	
11. Other City Ordinances and Policies	40	
12. Compliance with the Americans with Disabilities Act and Other Laws Concerning Accessibility	47	
13. Compliance with Environmental Laws and Related Matters	47	
3.4. Contract Disputes		52
1. General	52	
2. Claims	52	
3. Disputes	52	
3.5. Events of Default and Termination		53
1. Events of Default	53	
2. Cure or Default Notice	54	
3. Remedies	54	
4. Non-Exclusivity of Remedies	55	
5. City Reservation of Rights	55	

Cry r^r.-ii - ■ :.gf<<::>>?£!! Z^r^e; <■.!.!< L-Vo</r

6.	Early Termination	55	
	3.6. Department-specific Requirements		56
1.	Department of Aviation Standard Requirements	56	
2.	Emergency Management and Communications (OEMC) Security Requirements	59	
3.	Chicago Police Department Security Requirements	61	
4.	Department of Water Management ("DOWM") Security Requirements	62	
ARTICLE 4. TERMS FOR PROFESSIONAL SERVICES WITH WORK ;		65	
1.	Providing Services	65	
2.	Standard of Performance	65	
	4.2.2. Failure to Comply		66
3.	Deliverables	66	
4.	Additional Services	67	
5.	Timeliness of Performance	67	
	4.5.1. Time for Completing Punch List		67
6.	Suspension	67	
7.	Personnel	68	
	1. Adequate Staffing	68	
	2. Key Personnel	68	
	3. Salaries and Wages	68	
8.	Ownership of Documents	68	
9.	Copyright Ownership and other Intellectual Property	68	
	1. Patents	69	
	2. Indemnity	69	
10.	Approvals	69	
11.	Cooperation	69	
12.	Reimbursement for Travel	70	
13.	Standard Working Hours	70	
14.	Character of Workers	70	
15.	Quality of Materials and Inspection	70	
16.	Manufacturer's Warranty and Product Information	70	
17.	Contractor's Warranties	71	
	1. Correction or Re-Performance of Services	72	
	2. Timeliness	72	
	3. Delay	72	
18.	Work Performed on City Property	72	
19.	Contractor Practices At Site	73	
	1. Cooperation Among Contractors	73	
	2. Protection of Persons and Property	73	
	3. Protection of Streets, Alleys and Public Grounds	76	
	4. Protection of Existing Trees in the Right of Way	76	
	5. Care of Existing Structures and Property	77	
	6. Precautions and Safety	81	
	7. Health, Safety and Sanitation	82	
	8. Hazardous Operations and Security	83	
20.	Work In Progress	84	
21.	Final Completion and Acceptance of the Work	84	
22.	Representations and Covenants	85	
4.20.			
ARTICLE 5. SCOPE OF WORK AND DETAILED SPECIFICATIONS		87	
1.	Scope of Services	87	
2.	Authorized Dealer	87	
3.	List of Key Personnel	87	
4.	Term of Performance	88	
5.	Payment	88	
	1. Basis of Payment	88	
	2. Method of Payment	88	

3.	Criteria for payment	88	
6.	Funding	88	
7.	Project Phasing and Work Order Assignment	88	
1.	Procedure for Initiating Work Orders	89	
2.	Phase One Work Order Assignment	90	
8.	Task Orders	93	
9.	Notice to Proceed	93	
10.	Full Discipline Team	93	
11.	Performance Bond	93	
12.	Tax Benefits Disclaimer	94	
13.	City Directed Value Engineering	94	
14.	Value Engineering Proposals	94	
ARTICLE 6. SPECIAL CONDITIONS REGARDING MINORITY BUSINESS ENTERPRISE COMMITMENT AND WOMEN			
BUSINESS ENTERPRISE COMMITMENT IN CONSTRUCTION CONTRACTS		97	
	Attachment A -Assist Agency List (Rev. Sept 2016)		110
ARTICLE 7. INSURANCE REQUIREMENTS		113	
ARTICLE 8. SIGNATURE PAGE		116	
EXHIBIT 1: SCOPE OF WORK		118	
EXHIBIT 1A: LIGHTING TECHNICAL AND PERFORMANCE SPECIFICATIONS		121	
EXHIBIT 1B: LIGHTING MANAGEMENT SYSTEM FUNCTIONAL, TECHNICAL AND SERVICE REQUIREMENTS		189	
EXHIBIT 1C: ASSET CONDITION ASSESSMENT ATTRIBUTE LIST AND PLAN		252	
EXHIBIT 2: COMPENSATION		261	
EXHIBIT 3: INSURANCE CERTIFICATE OF COVERAGE		273	
EXHIBIT 4: ECONOMIC DISCLOSURE STATEMENT AND AFFIDAVIT(S)		275	
EXHIBIT 6: PERFORMANCE AND PAYMENT BOND		278	
EXHIBIT 7: DATA PROTECTION REQUIREMENTS FOR CONTRACTORS, VENDORS AND THIRD-PARTIES		283	
EXHIBIT 8: NEW INFORMATION SECURITY POLICIES		286	
EXHIBIT 9: EXISTING FIXTURE REMOVAL AND LED FIXTURE INSTALLATION SPECIFICATIONS		287	
EXHIBIT 10: INFRASTRUCTURE STABILIZATION ITEMS SCOPES OF WORK AND SPECIFICATIONS		292	
EXHIBIT 11: MAP OF SOCIOECONOMICALLY DISADVANTAGED AREAS		364	
EXHIBIT 12: AFFIDAVIT REGARDING IDENTIFICATION OF ALL WASTE AND MATERIAL HANDLING AND DISPOSAL FACILITIES		366	
EXHIBIT 13: CONTRACTOR'S COMMITMENT TO MINORITY AND FEMALE EMPLOYEE UTILIZATION GOALS		369	
EXHIBIT 14: CONTRACTOR'S CERTIFICATION REGARDING HAZARDOUS WASTE		371	
EXHIBIT 15: LED LUMINAIRE SPECIFICATIONS SUBMITTAL FORM		373	
EXHIBIT 16: LED CONVERSION PRICING SUBMITTAL		374	

ARTICLE 1. INTRODUCTION

This Contract is entered into as of the _____ day of _____, 2017 ("Effective Date") by and between AMERESCO, Inc., a Delaware corporation ("Contractor"), and the City of Chicago, a municipal corporation and home rule unit of local government existing under the Constitution of the State of Illinois, acting through its Department of Transportation and Department of Innovation and Technology ("City"), at Chicago, Illinois.

This Contract is for the design and implementation of a city-wide lighting modernization initiative, the Chicago Smart Lighting Project ("Project"), that will (1) increase the quality and reliability of Chicago's outdoor lighting system; (2) reduce its energy consumption and associated energy costs; (3) integrate

the lighting system with other City systems; and (4) create a new data collection platform (via sensors).

The Contractor warrants that it is ready, willing and able to perform as of the effective date of this Contract to the full satisfaction of the City.

NOW, THEREFORE, the City and the Contractor Agree as Follows:

ARTICLE 2. INCORPORATION OF EXHIBITS:

The following attached Exhibits are made a part of this agreement:

- Exhibit 1: Scope of Services and Time Limits for Performance
 - o Exhibit 1A: Lighting Technical and Performance Specifications
 - o Exhibit 1B: Lighting Management System Functional, Technical and Service Requirements
 - o Exhibit 1C: Asset Condition Assessment Attribute List and Plan
- Exhibit 2: Schedule of Compensation
 - o Exhibit 2A: LED Conversion Pricing Form
 - o Exhibit 2B: Infrastructure Stabilization Pricing Form
 - o Exhibit 2C: Technology/Lighting Management System Pricing Form
 - o Exhibit 2D: Markup for Management Costs, Profit and Overhead
- Exhibit 3: Example Insurance Certification and Evidence of Insurance
- Exhibit 4: Economic Disclosure Statement and Affidavit
- Exhibit 5: MBE/WBE Compliance Plan
- Exhibit 6: Contractor's Performance and Payment Bond
- Exhibit 7: Data Protection Requirements for Contractors, Vendors and Third Parties
- Exhibit 8: New Information Security Policies
- Exhibit 9: Existing Fixture Removal and LED Fixture Installation Specifications
- Exhibit 10: Infrastructure Stabilization Items Scopes of Work and Specifications
- Exhibit 11: Map of Socioeconomically Disadvantaged Areas
- Exhibit 12: Contractor's Affidavit Regarding Identification of All Waste and Material Handling and Disposal Facilities
- Exhibit 13: Contractor's Commitment to Minority and Female Employee Utilization Goals
- Exhibit 14: Contractor's Certification Regarding Hazardous Waste
- Exhibit 15: LED Luminaire Specifications Submittal Form
- Exhibit 16: LED Conversion Pricing Submittal

CSLP General Terms and Conditions

ARTICLE 3. GENERAL TERMS AND CONDITIONS

3.1. General Provisions 3.1.1. Definitions

"Addendum" is an official revision of the Bid Documents issued by the Chief Procurement Office prior to Bid Opening Date.

"Airports" means Chicago O'Hare International Airport and Chicago Midway International Airport.

"Airside" means, generally, those areas of an Airport which requires a person to pass through a security checkpoint to access. References to "sterile areas" generally mean Airside areas within terminal buildings. References to "Airfield", "Aircraft Operations Area", "AOA", or "Secured areas" generally mean outdoor Airside areas or areas not accessible to passengers.

"Atlas Page" means a 4 city-block x 4 city-block map grid that depicts the City's lighting assets on streets, alleys and viaducts.

"Attachments" are all the exhibits and other documents attached to the Bid Documents and/or incorporated into the Contract by reference.

"Bid" refers to an offer made by a Bidder in response to an invitation for bids which includes a binding proposal to perform the Contract which the City may rely on and accept, or in the case of an RFP or RFQ, the submission/proposal in response to that solicitation which may be subject to negotiation.

"Bidder" is a person, firm, or entity submitting a Bid in response to an invitation for bids; for RFPs and RFQs, references may be made to "Respondents." Once the Contract is awarded the Contractor shall assume that all references to a Bidder or Respondent and such attendant obligations apply to the Contractor.

"Bid Opening Date" is the date and time publicly advertised by the Chief Procurement Officer as the deadline for submission of Bids; this may

be referred to as a "Proposal Due Date" for RFP and RFQ solicitations.

"Bid Documents" means all the documents issued by the Chief Procurement Officer, or referenced by the Chief Procurement Officer as being available on the City's website and incorporated by such reference, in connection with an invitation for bids or proposals. Except for such Bid Documents as are posted on the City's website and incorporated by reference, all Bid Documents must be submitted by a bidder on the Bid Opening Date.

"Budget Director" means the budget director of the City's Office of Budget Management, and any representative duly authorized in writing to act on the Budget Director's behalf.

"Business Day" means business days (Monday through Friday, excluding legal holidays, or City shutdown days) in accordance with the City of Chicago business calendar.

"Calendar Day" means all calendar days in accordance with the world-wide accepted calendar.

"Chief Information Officer" ("CIO") means the Commissioner of the Department of Innovation and Technology ("DoIT"), and any representative duly authorized in writing to act on the CIO's behalf with respect to this Contract.

"Chief Procurement Officer" abbreviated as "CPO" means the chief executive of the City's Department of Procurement Services ("DPS"), and any representative duly authorized in writing to act on the Chief Procurement Officer's behalf.

"CIT" means the Chicago Infrastructure Trust.

"City" means the City of Chicago, a municipal corporation and home rule government under Sections 1 and 6(a), Article VII, of the 1970 Constitution of the State of Illinois.

CSLP General Terms and Conditions

"CMH" means luminaires utilizing Ceramic Metal Halide bulbs.

"Commissioner" means the chief executive of the Department of Transportation ("CDOT"), and any representative duly authorized in writing to act on the Commissioner's behalf with respect to this Contract.

"Contact Person" means the Contractor's management level personnel who will work as liaison between the City and the Contractor and be available to respond to any problems that may arise in connection with Contractor's performance under the Contract.

"Contract" or "Agreement" means, upon notice of award, the contract consisting of all Bid Documents relating to a specific invitation for bids or proposals, and all amendments, modifications, or revisions made from time to time in accordance with the terms thereof. All such documents comprising the Contract are referred to as the "Contract Documents".

"Contractor" means the Bidder or Proposer (person, firm, or entity) that is awarded the Contract by the CPO. Any references to the Bidder or Proposer in the Contract Documents is understood to apply to the Contractor.

"Contract Modification" means a written modification of the terms and conditions of this Contract.

"Cost Estimate" means a written cost proposal for Work prepared by Contractor pursuant to the Work Order procedures in Section 5.7.1.

"Department" which may also be referred to as the using/user Department is the City Department which appears on the applicable Purchase Order Release for goods, work, or services provided under this Contract.

"Detailed Specifications" refers to the contract specific requirements that includes but is not limited to a detailed description of the scope, term, compensation, price escalation, and such other additional terms and conditions governing this specific Contract.

"Final Completion and Acceptance of the Work" means the last date on which all of the following events have occurred: (i) all Work Orders have received Work Order Final Acceptance; (ii) the Commissioner has determined that all Punch List Work and any other remaining non-Work Order Work, including the technology scope of work, have been completed in accordance with the Contract; (iii) final inspections have been completed and operations systems and equipment testing have been completed; (iv) all deliverables have been provided to the Commissioner; and (v) all contractual requirements for final payment have been completed. Final Completion and Acceptance of the Work shall not include ongoing software licensing, network maintenance, or technology support services.

"Holidays" refers to the official City Holidays when the City is generally closed for business which includes: New Year's Day, Dr. Martin Luther King Jr.'s Birthday, Lincoln's Birthday, President's Day, Pulaski Day, Memorial Day, Independence Day, Labor Day, Columbus Day, Veteran's Day, Thanksgiving Day, and Christmas Day.

"HPS" means luminaires utilizing High Pressure Sodium bulbs. "LED Luminaire" means luminaires utilizing Light Emitting Diodes. "MCC" is the abbreviation for the Municipal Code of Chicago.

"Notice to Proceed" means written authorization from the Commissioner for Contractor to commence the specified Work on a specified date.

"Partial Work Order Substantial Completion" means that, in the opinion of the Commissioner, Contractor has completed a portion of the Work, in accordance with the Work Order and Section 4.16, and the City is able to occupy and use the portion of the Work Order completed for the purpose intended.

C5LP General Terms and Conditions

"Party" or collectively "Parties" refers to the entities that have entered into this Contract including the Contractor and the City.

"Phase" or "Project Phase" means the timeline associated with each Work Order, to be assigned sequentially over the term of the Contract.

"Punch List" or "Punch List work" means minor adjustments, repairs or deficiencies in the Work, as determined by the Commissioner in his or her sole discretion.

"Purchase Order" means a written purchase order from a Department referencing this Contract. Purchase Orders may also be referred to as "Blanket Releases".

"Services" refers to all work, services, and materials whether ancillary or as required by the Detailed Specifications that Contractor provides in performance of its obligations under this Contract.

"Specification" means the Bid Documents, including but not limited to the Detailed Specifications.

"Subcontractor" means any person or entity with whom the Contractor contracts to provide any part of the goods, services or work to be provided by Contractor under the Contract, including subcontractors of any tier, suppliers and material men, whether or not in privity with the Contractor.

"Substantial Completion Date" is the date upon which Contractor has met the requirements for Substantial Completion in the opinion of the Commissioner.

"Substantial Completion of the Project" or "Substantial Completion" means that, in the opinion of the Commissioner, Contractor has completed all Work in accordance with the Contract, except for Punch List Work, and the City is able to occupy and use the Project for the purpose intended.

"Task Order" means an approved proposal, as modified by negotiation between the City and Contractor, signed by the Commissioner and issued pursuant to the Task Order process set forth in Section 5.8 below.

"Task Order Request" means a written request from the City for Contractor to prepare and submit a proposal, including the cost proposal for the services relating to a specific project, and issued pursuant to the Task Order process set forth in Section 5.8 below.

"Work" means all labor, materials, equipment, deliverables, and other incidentals to be provided by Contractor under this Contract that are necessary or convenient to the successful completion of this Project and that are required by, incidental or collateral to the Contract.

"Work Order Substantial Completion" means that, in the opinion of the Commissioner, Contractor has completed all Work in accordance with the Work Order, except for Punch List Work, and the City is able to occupy and use the portion of the Project completed pursuant to the Work Order for the purpose intended.

"Work Order" means a written work order from a Department referencing this Contract.

"Work Order Final Acceptance" means the last date on which all of the following events have occurred for any given Work Order Release: (i) the Commissioner has determined that all Punch List Work and any other remaining Work has been completed in accordance with the Work Order scope of work; (ii) final inspections have been completed and operations systems and equipment testing have been completed, if required by the Work Order; (iii) all deliverables required in the Work Order scope of work have been provided to the Commissioner; and (iv) all contractual requirements for final payment with respect to the Work Order have been completed.

3.1.2. Interpretation of Contract 3.1.2.1. Order of Precedence

The order of precedence of the component contract parts will be as follows: • CSLP General Terms and Conditions

- Terms for Professional Services with Work
- Scope of Work and Detailed Specifications
- Work Order or Task Order Terms (if applicable)
- Performance Bond, if required
- All other parts of this Contract.

2. Interpretation and Rules

Unless a contrary meaning is specifically noted elsewhere, the phrases "as required", "as directed", "as permitted", and similar words mean the requirements, directions, and permissions of the Commissioner or CPO, as applicable. Similarly, the words "approved", "acceptable", "satisfactory", and similar words mean approved by, acceptable to, or satisfactory to the Commissioner or the CPO, as applicable. The term "include" (in all its forms) means "include, without limitation" unless the context clearly states otherwise.

The words "necessary", "proper", or similar words used with respect to the nature or extent of work or services mean that work or those services must be conducted in a manner, or be of a character which is necessary or proper for the type of work or services being provided in the opinion of the Commissioner or the CPO, as applicable. The judgment of the Commissioner or the CPO in such matters will be considered final.

Wherever the imperative form of address is used, such as "provide equipment required" it will be understood and agreed that such address is directed to the Contractor unless the provision expressly states that the City will be responsible for the action.

3. Severability

The invalidity, illegality, or unenforceability of any one or more phrases, sentences, clauses, or sections in this Contract does not affect the remaining portions of this Contract.

4. Entire Contract

The Contract Documents constitute the entire agreement between the parties and may not be modified except by the subsequent written agreement of the parties.

3.1.3. Subcontracting and Assignment

1. No Assignment of Contract

Pursuant to 65 ILCS 5/8-10-14, Contractor may not assign this Contract without the prior written consent of the Commissioner. In no case will such consent relieve the Contractor from its obligations, or change the terms of the Contract. The Contractor must notify the Commissioner, in writing, of the name of any proposed assignee and the reason for the assignment; consent to which is solely in the Commissioner's discretion.

2. Subcontracts

No part of the goods, work, or services to be provided under this Contract may be subcontracted without the prior written consent of the Commissioner; but in no case will such consent relieve the Contractor from its obligations, or change the terms of the Contract. The Contractor must notify the Commissioner of the names of all Subcontractors to be used and shall not employ any that the Commissioner has not approved. Prior to proposing the use of a certain Subcontractor, the Contractor must verify that neither the Subcontractor nor any of its owners is debarred from or otherwise ineligible to participate on City contracts. This information can be found on the City's website: <http://www.cityofchicago.org/city/en/dept5/dps/provdrs/comp/svcs/debarred_firms_list.html>

Subcontracting of the services or work or any portion of the Contract without the prior written consent of the Commissioner is null and void. Further, the Contractor will not make any substitution of a previously approved Subcontractor without the prior written consent of the

CSLP General Terms and Conditions

Commissioner; any substitution of a Subcontractor without the prior written consent of the Commissioner is null and void.

The Contractor will only subcontract with competent and responsible Subcontractors. If, in the judgment of the Commissioner, any Subcontractor is careless, incompetent, violates safety or security rules, obstructs the progress of the services or work, acts contrary to instructions, acts improperly, is not responsible, is unfit, is incompetent, violates any laws applicable to this Contract, or fails to follow the requirements of this Contract, then the Contractor will, immediately upon notice from the Commissioner, discharge or otherwise remove such Subcontractor and propose an acceptable substitute for Commissioner approval.

3. No Pledging or Assignment of Contract Funds Without City Approval

The Contractor may not pledge, transfer, or assign any interest in this Contract or contract funds due or to become due without the prior written approval of the Commissioner. Any such attempted pledge, transfer, or assignment, without the prior written approval of the Commissioner is void as to the City and will be deemed an event of default under this Contract.

4. City's Right to Assign

The City expressly reserves the right to assign or otherwise transfer all or any part of its interests in this Contract without the consent or approval of the Contractor.

5. Assigns

All of the terms and conditions of this Contract are binding upon and inure to the benefit of the parties hereto and their respective legal representatives, successors, transferees, and assigns.

3.1.4. Contract Governance

1. Governing Law and Jurisdiction

This Contract will be governed in accordance with the laws of the State of Illinois, without regard to choice of law principles. The Contractor hereby irrevocably submits, and will cause its Subcontractors to submit, to the original jurisdiction of those State or Federal courts located within the County of Cook, State of Illinois, with regard to any controversy arising out of, relating to, or in any way concerning the execution or performance of this Contract and irrevocably agrees to be bound by any final judgment rendered thereby from which no appeal has been taken or is available. The Contractor irrevocably waives any objection (including without limitation any objection of the laying of venue or based on the grounds of forum non conveniens) which it may now or hereafter have to the bringing of any action or proceeding with respect to this Contract in the jurisdiction set forth above.

2. Consent to Service of Process

The Contractor agrees that service of process on the Contractor may be made, at the option of the City, either by registered or certified mail addressed to the applicable office as provided for in this Contract, by registered or certified mail addressed to the office actually maintained by the Contractor, or by personal delivery on any officer, director, or managing or general agent of the Contractor. The Contractor designates and appoints the representative identified on the signature page hereto under the heading "Designation of Agent for Service Process", as its agent in Chicago, Illinois, to receive on its behalf service of all process (which representative will be available to receive such service at all times), such service being hereby acknowledged by such representative to be effective and binding service in every respect. Said agent may be changed only upon the giving of written notice by the Contractor to the City of the name and address of a new Agent for Service of Process who works within the geographical boundaries of the City of Chicago. Nothing herein will affect the right to serve process in any other manner permitted by law or will limit the right of the City to bring proceedings against the Contractor in the courts of any other jurisdiction.

3. Cooperation by Parties and between Contractors

The Parties hereby agree to act in good faith and cooperate with each other in the performance of this Contract. The Contractor further agrees to implement such measures as may be necessary to

CSLP General Terms and Conditions

ensure that its staff and its Subcontractors will be bound by the provisions of this Contract. The City will be expressly identified as a third party beneficiary in the subcontracts and granted a direct right of enforcement thereunder.

Contractor must perform its Services so as not to interfere with or hinder the progress of completion of the work being performed by other contractors. Contractor must promptly notify the Commissioner upon becoming aware of a potential delay caused by another contractor within or adjacent to the project site.

Each Contractor involved shall assume all liability, financial or otherwise, in connection with its contract, and shall protect and hold harmless the City from any and all damages or claims that may arise because of inconvenience, delay, or loss attributable to the Contractor's own negligence or willful misconduct. Each Contractor shall assume all responsibility for all work not completed or accepted due to delays within Contractor's control, or those delays caused by third-party contractors which Contractor reasonably could have known but failed to report to the Commissioner, as required above.

The Contractor must as far as possible, arrange its work and space and dispose of the materials being used, so as not to interfere with the operations of the other contractors within or adjacent to the limits of the project site.

It is further expressly understood and agreed that the Contractor shall not be entitled to any damages or compensation from the City, or be reimbursed for any loss or expense on account of any delay or delays resulting from the actions of third-party contractors working within or adjacent to the project site.

4. No Third Party Beneficiaries

The parties agree that this Contract is solely for the benefit of the parties and nothing herein is intended to create any third party

beneficiary rights for subcontractors or other third parties.

5. Independent Contractor

This Contract is not intended to and does not constitute, create, give rise to, or otherwise recognize a joint venture, partnership, corporation or other formal business association or organization of any kind between Contractor and the City. The rights and the obligations of the parties are only those set forth in this Contract. Contractor must perform under this Contract as an independent contractor and not as a representative, employee, agent, or partner of the City.

This Contract is between the City and an independent contractor and, if Contractor is an individual, nothing provided for under this Contract constitutes or implies an employer-employee relationship such that:

The City will not be liable under or by reason of this Contract for the payment of any workers' compensation award or damages in connection with the Contractor performing the Services required under this Contract.

Contractor is not entitled to membership in any City Pension Fund, Group Medical Insurance Program, Group Dental Program, Group Vision Care, Group Life Insurance Program, Deferred Income Program, vacation, sick leave, extended sick leave, or any other benefits ordinarily provided to individuals employed and paid through the regular payrolls of the City.

The City is not required to deduct or withhold any taxes, FICA or other deductions from any compensation provided to Contractor.

6. Authority

Execution of this Contract by the Contractor is authorized and signature(s) of each person signing on behalf of the Contractor have been made with complete and full authority to commit the Contractor to all terms and conditions of this Contract, including each and every representation, certification, and warranty contained herein, attached hereto and collectively incorporated by reference herein,

CSLP General Terms and Conditions

or as may be required by the terms and conditions hereof. If other than a sole proprietorship, Contractor must provide satisfactory evidence that the execution of the Contract is authorized in accordance with the business entity's rules and procedures.

7. Joint and Several Liability

In the event that Contractor, or its successors or assigns, if any, is comprised of more than one individual or other legal entity (or a combination thereof), then and in that event, each and every obligation or undertaking herein stated to be fulfilled or performed by Contractor will be the joint and several obligation or undertaking of each such individual or other legal entity.

8. Notices

All communications and notices to the City from the Contractor must be faxed, delivered personally, electronically mailed or mailed first class, postage prepaid, to the Commissioner of the using Department that appears on the applicable Purchase Order.

A copy of any communications or notices to the City relating to Contract interpretation, breach/default, a dispute, or indemnification obligations shall also be sent by the same means set forth above to the Department of Law, Room 600, City Hall, 121 N LaSalle Street, Chicago, Illinois 60602.

All communications and notices from the City to the Contractor, unless otherwise provided for, will be faxed, delivered personally, electronically mailed or mailed first class, postage prepaid, to the Contractor care of the name and to the address listed below:

AMERESCO, Inc. Steve Taggart Regional
Director
150 N. Michigan Avenue, Suite 420 Chicago, Illinois 60601 Tel: (312)
994-8620 staggart@ameresco.com
<mailto:staggart@ameresco.com>

A copy of any communications or notices from the City to the Contractor relating to Contract interpretation, breach/default, a dispute, or indemnification obligations shall also be sent by the same means set forth above to:

AMERESCO, Inc.
III Speen Street, Suite 410
Framingham, Massachusetts 01701
Attn: General Counsel
Fax: (508)598-3219

9. Amendments

Following Contract award, no change, amendment, or modification of the Contract Documents or any part thereof, is valid unless stipulated in writing and signed by the Contractor, Commissioner and CIO, and Budget Director, after review for form and legality by the Corporation Counsel, unless specifically allowed for by the Contract Documents.

3.1.4.10. No Waiver of Legal Rights

Neither the acceptance by the City, or any representative of the City, nor any payment for or acceptance of the whole or any part of the deliverables, nor any extension of time, nor any possession taken by the City, shall operate as a waiver by the City of any portion of the Contract, or of any power herein reserved or any right of the City to damages herein provided.

CSLP General Terms and Conditions

A waiver of any breach of the Contract shall not be held to be a waiver of any other or subsequent breach. Whenever under this Contract the City by a proper authority waives the Contractor's performance in any respect or waives a requirement or condition to either the City's or the Contractor's performance, the waiver so granted, whether express or implied, shall only apply to the particular instance and will not be deemed a waiver forever or for subsequent instance of the performance, requirement, or condition. No such waiver shall be construed as a modification of this Contract regardless of the number of time the City may have waived the performance, requirement, or condition.

11. Non-appropriation of Funds

Pursuant to 65 ILCS 5/8-1-7, any contract for the expenditure of funds made by a municipality without the proper appropriation is null and void.

If no funds or insufficient funds are appropriated and budgeted in any fiscal period of the City for payments to be made under this Contract, then the City will notify the Contractor of that occurrence and this Contract shall terminate on the earlier of the last day of the fiscal period for which sufficient appropriation was made or whenever the funds appropriated for payment under this Contract are exhausted.

No payments will be made to the Contractor under this Contract beyond those amounts appropriated and budgeted by the City to fund payments under this Contract.

12. Joint Purchasing Agreement

Any City of Chicago sister agency contract pursuant to this Contract must be in accordance with all ordinances and resolutions concerning cooperative governmental purchasing under the joint purchase agreement approved by the City Council (Journal of Proceedings, City Council, Chicago, April 20, 1964, page 2589-2590, by the Cook County Board of Commissioners on April 9, 1965) and any amendments thereto to the extent allowed by law, and as may be permitted by the Chief Procurement Officer, the Contractor will make the pricing set forth in this Contract available to any of the following City of Chicago sister agencies: Chicago Park District, Chicago Public Schools, Chicago Board of Education, City Colleges, Chicago Transit Authority, Chicago Board of Elections, Metropolitan Pier & Exposition Authority, McCormick Place, Municipal Courts, or the Chicago Housing Authority.

All orders that are placed by any of the City of Chicago sister agencies listed in this Section 3.1.4.12 may be made pursuant to separate agreements entered into by and between the sister agency and the Contractor and subject to the rules, regulations and policies governing the sister agency, and such orders may be billed directly to the agency that placed the order. The City is NOT liable for any payment for costs incurred by a Chicago sister agency. No governmental entity other than the City of Chicago and its User Departments may place orders under this Contract.

13. Participation By Other Agencies

Other agencies may be eligible to participate in this Contract if (a) such agencies are authorized, by law or their governing bodies, to execute such purchases, (b) such authorization is consented to by the Commissioner, and (c) such purchases have no net adverse effect on the City of Chicago and result in no diminished services from the Contractor to the City's Departments.

Said purchases will be made upon the issuance of a purchase order directly from the agency. The City will not be responsible for payment of any amounts owed by any other agencies, and will have no liability for the acts or omissions of any other agency.

3.1.5. Confidentiality

All deliverables and reports, data, findings or information in any form prepared, assembled or encountered by or provided by Contractor under this Contract are property of the City and are confidential, except as specifically authorized in this Contract or as may be required by law. Contractor must not allow the Deliverables to be made available to any other individual or organization without the

prior written consent of the City. Further, all documents and other information provided to Contractor by the City are confidential and must not be made available to any other individual or organization without the prior written consent of the City. Contractor must implement such measures as may be necessary to ensure that its staff and its Subcontractors are bound by the confidentiality provisions contained in this Contract. <_

Contractor must not issue any publicity news releases or grant press interviews, and except as may be required by law during or after the performance of this Contract, disseminate any information regarding its Services or the project to which the Services pertain without the prior written consent of the Commissioner.

If Contractor is presented with a request for documents by any administrative agency or with a subpoena duces tecum regarding any records, data or documents which may be in Contractor's possession by reason of this Contract, Contractor must immediately give notice to the Commissioner, CPO and the Corporation Counsel for the City with the understanding that the City will have the opportunity to contest such process by any means available to it before the records or documents are submitted to a court or other third party. Contractor, however, is not obligated to withhold the delivery beyond the time ordered by the court or administrative agency, unless the subpoena or request is quashed or the time to produce is otherwise extended.

3.1.6. Indemnity

Contractor must defend, indemnify, keep and hold harmless the City, its officers, representatives, elected and appointed officials, agents and employees (collectively, the "Indemnified Parties,") from and against any and all Losses (as defined below), in consequence of the granting of this Contract or arising out of or being in any way connected with the Contractor's performance under this Contract, except as otherwise provided in 740 ILCS 35 "Construction Contract Indemnification for Negligence Act" if it applies, including those related to: injury, death or damage of or to any person or property; any infringement or violation of any property right (including any patent, trademark or copyright); failure to pay or perform or cause to be paid or performed Contractors covenants and obligations as and when required under this Contract or otherwise to pay or perform its obligations to any subcontractor; the City's exercise of its rights and remedies under this Contract; and injuries to or death of any employee of Contractor or any subcontractor under any workers compensation statute. When 740 ILCS 35 applies, indemnification provided by the Contractor to the Indemnified Parties will be to the maximum extent permitted under applicable law.

"Losses" means, individually and collectively, liabilities of every kind, including monetary damages and reasonable costs, payments and expenses (such as, but not limited to, court costs and reasonable attorneys' fees and disbursements), claims, demands, actions, suits, proceedings, fines, judgments or settlements, any or all of which in any way arise out of or relate to the negligent or otherwise wrongful errors, acts, or omissions of Contractor, its employees, agents and subcontractors.

The Contractor will promptly provide, or cause to be provided, to the Commissioner and the Corporation Counsel copies of such notices as Contractor may receive of any claims, actions, or suits as may be given or filed in connection with the Contractor's performance or the performance of any Subcontractor and for which the Indemnified Parties are entitled to indemnification hereunder.

At the City Corporation Counsel's option, Contractor must defend all suits brought upon all such Losses and must pay all costs and expenses incidental to them, but the City has the right, at its option, to participate, at its own cost, in the defense of any suit, without relieving Contractor of any of its obligations under this Contract. Any settlement must be made only with the prior written consent of the City Corporation Counsel, if the settlement requires any action on the part of the City.

The Contractor shall be solely responsible for the defense of any and all claims, demands, or suits against the Indemnified Parties, including without limitation, claims by an employee, subcontractors, agents, or servants of Contractor even though the claimant may allege that the Indemnified Parties were in charge of the work or service performed under the Contract, that it involves equipment owned or

CSLP General Terms and Conditions

furnished by the Indemnified Parties, or allege negligence on the part of the Indemnified Parties. The City will have the right to require Contractor to provide the City with a separate defense of any such suit.

To the extent permissible by law, Contractor waives any limits to the amount of its obligations to indemnify, defend or contribute to any sums due to third parties arising out of any Losses, including but not limited to any limitations on Contractor's liability with respect to a claim by any employee of Contractor arising under the Workers Compensation Act, 820 ILCS 305/1 et seq. or any other related law or judicial decision (such as, *Kotecki v. Cyclops Welding Corporation*, 146 Ill. 2d 155 (1991)). The City, however, does not waive any limitations it may have on its liability under the Illinois Workers Compensation Act, the Illinois Pension Code or any other statute.

The indemnities in this section survive expiration or termination of this Contract for matters occurring or arising during the term of this Contract or as the result of or during the Contractor's performance of work or services beyond the term. Contractor acknowledges that the requirements set forth in this section to indemnify, keep and save harmless and defend the City are apart from and not limited by the Contractor's duties under this Contract, including the insurance requirements set forth in the Contract.

7. Non-Liability of Public Officials

Contractor and any assignee or Subcontractor of Contractor must not charge any official, employee or agent of the City personally with any liability or expenses of defense or hold any official, employee or agent of the City personally liable to them under any term or provision of this Contract or because of the City's execution, attempted execution or any breach of this Contract.

8. Force Majeure

Neither Party shall be liable for any damages, delays or failure in performance under this Contract caused by acts or conditions beyond its reasonable control or without its fault or negligence ("Force Majeure Event"), including acts of God, explosion, acts of the public enemy, fires, floods, earthquakes, tornadoes, epidemics, quarantine restrictions, or work stoppages not caused or unmitigated by the Contractor. A Party shall, in order to avail itself of any of the provisions of this section, promptly send a written notice of the Force Majeure Event to the other Party, including a description of the Force Majeure Event, its expected duration and a description of the actions being taken by the Party to mitigate the effect of the Force Majeure Event.

3.2. Compensation Provisions

Sections 3.2.1. through 3.2.9. below apply only to construction work items. Section 3.2.10. below applies to all other portions of the Project. Sections 3.2.11. through 3.2.17. below apply to all portions of the Project.

3.2.1. Contract Price

In the case of a lump sum line item, Contractor must provide the Commissioner with a breakdown that includes a schedule of costs for the various parts of the Work included in the lump sum. The total of these costs must equal the lump sum line items.

The breakdown must be submitted in such form and detail, and supported as to correctness by such data, as the Commissioner may direct. The City will make no payment until the breakdown has been submitted and the Commissioner has approved it. The breakdown may be used for verifying monthly progress payments upon substantiation of the costs detailed and the progress of the Work.

For unit price line items, measurement and payment is as specified in the Detailed Specifications.

3.2.1.1. Price Adjustment (CCI)

This section will apply to unit prices for Infrastructure Stabilization Work and LED Conversion Work (excluding the LED Luminaires) only. Prices will remain fixed throughout the first twelve (12) calendar months of the Contract term. Beginning on the date after the initial twelve (12) month term, and for each twelve (12) month anniversary thereafter, subject to acceptable performance by the Contractor and contingent upon the appropriation of sufficient funds for the procurement of

CSLP General Terms and Conditions

services provided for in this Contract, annual price adjustments of the Contract pricing may be made after receipt of written request from the Contractor showing cause substantiating the need for the increase, made no later than thirty (30) calendar days after the expiration of each such twelve (12) month period. If Contractor does not request a price adjustment within such thirty (30) calendar day period, Contractor will not be entitled to a price adjustment for the upcoming year.

The increase or decrease will be based upon changes in the Construction Cost Index ("CCI") published in the ENR, Engineering News-Records (a division of McGraw-Hill Companies) for Chicago, Illinois. CCI indices are published monthly. Any adjustment to the original bid prices will take effect for the purposes of this clause for all Work Orders issued on or after each twelve (12) month anniversary of the Contract, and will not apply to Work begun but not completed, for any reason, during the previous twelve (12) months of the Contract.

The adjusted Contract price will be determined by performing the following calculation: The original Contract price(s) will be multiplied by the quotient, and then be rounded to two (2) decimal places to calculate the adjusted Contract price(s). The quotient will be calculated by dividing the comparison index value by the average index value of the last twelve (12) months of the Contract period.

The comparison value for the first allowable price increase will be the index value at the time of Contract award. The comparison value for the second allowable price increase will be the index value of the one (1) year anniversary date of the Contract award.

All price adjustment calculations will be based upon the latest version of the CCI available on the eighteenth (18th) day of the month following the anniversary of the Contract. The effective date of an adjustment will be the twentieth (20th) day of the month following the month in which the adjustment is requested.

If during the term of the Contract, the manner in which the CCI is determined by ENR is substantially revised, including a change in the base index year, the City will make adjustments in the revised index that would produce results equivalent, as nearly possible, to those that would have been obtained if the CCI had not been so revised. If the CCI becomes unavailable to the public because publication is

discontinued, or otherwise, or if equivalent data is not readily available to enable the City to make the adjustment, then the City will substitute for it a comparable index based upon changes in the cost of construction published by a governmental agency or, if no such index is available, then a comparable index published by a university or a recognized trade publication.

Notwithstanding the above, no annual price increase will exceed 3% of the unit price for Infrastructure Stabilization Work or LED Conversion Work, as applicable.

Price adjustments pursuant to this section must be signed in writing by the Commissioner and Contractor but shall not require a formal amendment.

3.2.2. Procedure for Monthly Payment Requests and Final Payment

Contractor and the City will agree upon a payment schedule of at least once per month, or more frequently if appropriate or if specified elsewhere in the Contract. The Commissioner will process payment requests pursuant to that agreement if Contractor's payment requests, in the Commissioner's sole judgment, are acceptable in form and content, and if the Work for which payment is being requested has been completed according to the terms and conditions of this Contract. All payment requests are subject to correction by the Commissioner.

In cases where Contractor proceeds to perform and complete the Work properly under the Contract, progress payments will be processed on a monthly basis unless the amount earned is greater than \$1,000,000, then payments may be made twice a month. The payment period ends on the monthly anniversary date of the Notice to Proceed.

CSLP General Terms and Conditions

Each monthly payment request must include one original and two copies of the following:

- a. Certified Statement. Contractor must submit certified statement(s) (signed by an authorized individual and notarized) for each payment request; the statement, in the form acceptable to the Commissioner, must list the following for Contractor and for each Subcontractor and supplier for the period for which payment is requested:
 - (1) the name and business address of the particular Subcontractor or supplier;
 - (2) description of the work performed and/or product supplied;
 - (3) the total amount of the particular subcontract;
 - (4) the amount previously paid to the Subcontractor and the dates paid;
 - (5) the amount of the monthly pay request Contractor will pay to each individual Subcontractor and/or supplier from payments Contractor receives on the request, and the dates those amounts were invoiced or requested by the Subcontractor or supplier;
 - (6) the balance remaining under the subcontract to complete the Work.
- b. Partial Waivers of Lien to Date and Affidavit for Payment. Following the first payment request, Contractor must submit Partial Waivers of Lien from all Subcontractors and suppliers that performed services and provided supplies during the month before the previous payment request. The Partial Waivers of Lien must be in a form acceptable to the City and must identify, at a minimum, the payment request number and time period covered. The Partial Waiver of Lien must be in dollar amount equal to the dollar amount of the services performed or supplies provided by the Subcontractor or supplier during the relevant time period. With every payment request, Contractor must also submit an Affidavit for Payment from all Subcontractors and suppliers for whose services or supplies payment is requested. The Affidavit for payment must be in a form acceptable to the Commissioner and identify, at a minimum, the payment estimate number, the time period covered, and the total amount invoiced by the Subcontractor or supplier, and the total amount paid to the Subcontractor or supplier to date.
- c. Status Report of MBE/WBE Subcontract Payments. A status report of MBE/WBE Subcontractor payments, as required by the Contract documents, must be submitted with each monthly invoice in the form required by the City.
- d. Certified Payrolls. Contractor and all Subcontractors working on the job site must submit three copies of certified payrolls for the payment period to the Commissioner every week until all Work is completed. All payrolls must be identified with Contractor or Subcontractor's name, as appropriate, Contract name and be sequentially numbered. If there are periods of no Work by you or a Subcontractor, Contractor must submit a payroll labeled "NO WORK." The final payroll must be clearly labeled "FINAL". Certified payrolls are required to assure EEO compliance as well as wage compliance. Race, worker classification, and gender must be clearly marked for each employee on the certified payroll along with all additional information required by the Chief Procurement Officer. An employee's address should appear every time his or her name appears on the payroll. Contractor must submit the

certified payrolls and additional information regarding EEO and wage compliance by providing a Payroll Summary Report in the form required by the Chief Procurement Officer. Contractor and each Subcontractor must submit the EEO report forms required by the City and U.S. Department of Labor reflecting fully the periods of Work covered by the partial payment request. When directed, Contractor shall be required to submit payrolls electronically using the City's certified payroll and reporting system.

- e. Pursuant to MCC 2-92-730, contractors are required to declare subcontractor payments with each invoice submitted. This reports the intended payments from prime contractors to

b.

CSLP General Terms and Conditions

subcontractors and suppliers from the invoice. The Subcontractor Payment Certification Form can be downloaded from the City's website at www.cityofchicago.org/finance/subcontractorform <<http://www.cityofchicago.org/finance/subcontractorform>>. The information from this form will be recorded in the City's financial system and posted on the City website.

3.2.3. Payment for Stored Material

(1) Whether stored on- or off-the job site, the risk of loss for stored material will remain with Contractor, and Contractor must insure the stored materials against the risk of loss, theft or damage until its installment in the Work.

(2) Payment for material stored on the job site will be 100% of a valid invoice. No payment will be made for materials stored off the job site unless otherwise authorized by the Commissioner in accordance with paragraph (3) of this Section 3.2.3, "Payment for Stored Material". If Materials stored on the job site cannot be incorporated in the finished Work within a reasonable period of time Contractor may include them in the monthly progress payment, but only if the following documents are submitted with the request for payment:

- a. Paid invoices showing the cost of material or equipment;
- b. Waiver of lien from the supplier indicating that the cost of the material or equipment was paid; and
- c. Inspection tickets showing that material or equipment had been inspected and accepted by the City.

(3) Payment for material stored off-site, if authorized, will be 100% of a valid invoice when Contractor has provided the Commissioner with the documents and assurances listed and complied with the requirements below:

- a. A paid invoice from the supplier showing the unit, quantity, description of the material or equipment and costs;
- b. A waiver of lien from the supplier for the total amount of the material purchased;
- c. Inspection for all of the material stored;
- d. A certified statement giving the exact location of the materials or equipment, stating that:
 - (1) Contractor has inspected all of the material stored and that it is complete and in good condition;
 - (2) the materials are suitably stored and maintained at a bonded, secure and environmentally appropriate location that the Commissioner has agreed upon and subject to the conditions required or established by him;
 - (3) Contractor has complied with procedures satisfactory to the Commissioner to establish the City's title to the materials or otherwise protect the City's interest in them, including, insurance, storage and transportation to the Project site for the materials stored off-site, as the Commissioner may reasonably require;
 - (4) the materials, equipment and associated fabricated components will not be diverted away from the Project;
 - (5) a certificate of insurance coverage for the stored material upon which payment is requested;

- e. Immediately upon receipt of payment for the material, Contractor must prepare and execute all documents required to transfer title to the City, including, any Uniform Commercial Code documentation necessary to perfect transfer of title; and

e.

CSLP General Terms and Conditions

- f. All material and Work covered by payments will thereupon become the sole property of the City, subject to Contractor's obligation to insure it until Acceptance of the Work.

4. Retainage

Retainage will be computed, held, and released based on the value of each LED conversion or infrastructure stabilization repair Work Order for Work issued.

The City will retain 10% of each approved periodic payment estimate of each Work Order for the first 50% of the approved Contract value including any approved change orders.

Upon Work Order Final Acceptance and prior to computation of the final quantities, 2% of the total amount of the Work Order including any approved change orders will be retained out of said aforementioned reserve and the balance released to the Contractor.

Upon (a) Contract closeout; (2) Contractor's compliance with the Contract's conditions for payment and performance of the Work of the Work Orders and all non-Work Order Work covered by the Contract in accordance with the terms and conditions thereof and compliance with all other terms and conditions of the Contract; (3) payment to all subcontractors, workers, employees, suppliers and material men for Work of the Work Orders performed and materials supplied; and (4) computation of the final quantities of Work of the Work Orders, said retained amount, less any damages or other amounts that Commissioner determines should be deducted, will be paid to the Contractor as final payment.

Notwithstanding the provisions in the above paragraphs, the City may, at the discretion of the Commissioner, decline to reduce the retainage held by the City and/or increase the amounts withheld as retainage from payment to Contractor if the Commissioner considers Contractor's performance of the Work to be such that the amounts due the City pursuant to the Contract, including damages for late performance, exceed or may exceed the amount of retainage held by the City.

5. Payments Withheld

(A) The Commissioner may decline a request for payment if, in the Commissioner's sole opinion, the request for payment is not adequately supported. If Contractor and the Commissioner cannot agree on a revised amount, the Commissioner must process the payment in the amount he deems appropriate.

(B) The Commissioner may decline to process any payment or may rescind in whole or in part any approval previously made to the extent that may be necessary in his or her sole opinion because of any failure to perform any obligation under the Contract, including:

- (1) Failure or refusal to provide the City the required initial schedule for the Work or monthly schedule updates and obtain the City's approval for either or both;
- (2) Contractor's failure to remedy defective Work;
- (3) Contractor's failure to make payments to Subcontractors, or employees, or provide partial waivers of lien;
- (4) Contractor's failure to maintain timely progress of the Work as stated in the schedule, or the City's determination that the Work will not be completed within the Contract Time, or Contractor's failure to carry out the Work in accordance with the Contract;
- (5) Failure to follow the City, State, Federal, or Contract safety and security requirements;
- (6) Failure to maintain insurance policies as required by the Contract and/or to provide to the Commissioner each evidence of insurance coverage, in the form of current certificates of insurance, as he or she may require;
- (7) Failure to comply with other requirements as referenced in the Contract;
- (8) Failure to provide certified payrolls;
- (9) Failure to provide material inspections as required by the Contract; and
- (10) Failure to provide contract deliverables such as, accurate Record Drawings, warranties, guarantees, manuals, etc.

(1)

CSLP General Terms and Conditions

(C) Pursuant to § 2-92-270 of the Municipal Code, the Chief Procurement Officer may, in his or her sole discretion, direct that no further payments be made, or vouchers or estimates issued to Contractor, if he or she determines that Contractor has failed to pay any Subcontractor, employee or worker for Work performed under this Contract. The City may withhold payment until Contractor demonstrates, to the satisfaction of the Chief Procurement Officer, that payments to the Subcontractors, employees or workers have been made in full.

If the Chief Procurement Officer gives Contractor notice that no further vouchers or estimates will be issued or payments made on the Contract until the Subcontractors, workers, and employees have been paid, and Contractor neglects or refuses for a period of 10 days or more after notice was given to pay those Subcontractors, workers or employees, the Chief Procurement Officer may apply any money due, or that may become due, under the Contract to the payment of those Subcontractors, workers or employees without further notice to Contractor and the effect will be the same, for purposes of payment to Contractor of the Contract Price, as if the City had paid Contractor directly.

The failure of the City, however, to retain and apply any money, or of the Chief Procurement Officer to order or direct that no

vouchers or estimates be issued or further payments made, will not, nor will the paying over of the reserved percentage without the Subcontractor, workers, or employees being first paid, in any way affect Contractor's liability or that of its sureties to the City, or to any such Subcontractor, worker or employee upon any bond given in connection with this Contract.

(D) Provisions Relating to Liens

Contractor will notify Subcontractors that no mechanic's lien under the Illinois Mechanics' Lien Act, 770 ILCS 60/23, et seq., will be permitted to arise, be filed, or maintained against public funds, the Project, or any part of it, or any interest in them, or any improvements on them, or against any monies due or to become due to Contractor on account of any work, labor, services, materials, equipment, or other items performed or furnished for or in connection with the Project to the extent permitted by law. Contractor, for itself and its Subcontractors, expressly waives, releases, and relinquishes such liens and all rights to file or maintain such liens; and Contractor further covenants that this waiver of liens and waiver of the rights to file or maintain such liens is an independent covenant.

If any of Subcontractors, employees, officials, agents, or any other person directly or indirectly acting for, through, or on their behalf files or maintains a lien or claim under the Illinois Mechanic's Lien Act, 770 ILCS 60/23, et seq., against public funds or against any monies due or to become due to Contractor on account of any Work, labor, services, materials, equipment, or other items performed or furnished for or in connection with the Project, Contractor must cause such liens and claims to be satisfied, removed, or discharged within 30 days from the date of filing. The City may extend the 30 day period if (i) the City determines that the lien claim cannot be so satisfied, removed, or discharged in such period and (ii) Contractor, in the City's sole determination, is proceeding diligently to cause such liens or claims to be satisfied, removed or discharged. The City has the right, in addition to all other rights and remedies provided under this Contract or by law, to cause such liens or claims to be satisfied, removed, or discharged by any means at Contractor's sole cost, such cost to include reasonable legal fees.

(E) The City's rights under this Section 3.2.5, "Payments Withheld," are cumulative with any other rights provided for under this Contract. Failure by the City to exercise any such right afforded in this Contract, or at law or in equity, will not constitute a waiver of that right.

3.2.6. Payment for Changes

(A) Payment for Changes. The amount to be paid by the City for changes (additions, deletions or revisions) in the Work or directions to change the Contract time, will be made in accordance with Sections 3.2.6(A)(1) through 3.2.6(A)(6) below. However, this Section 3.2.6 shall not apply when

CSLP General Terms and Conditions

revisions to any given Work Order's scope of work do not change the Contract time of completion or quantities; such revisions to the work will be performed by Contractor at no additional cost to the City.

- (1) Unit Price Basis. Should the changes in the plans result in an increase or decrease in the quantities of unit priced Work to be performed, Contractor will accept payment as follows:
 - (a) All increases in the Work of the type that appears in the Contract as unit price items will, except as provided in Section 3.2.6(A)(2), "Proposal Basis," be paid for at the Contract unit bid prices. Decreases in quantities included in the Contract will be deducted from the Contract value at the unit bid prices. No allowances will be made for delays or anticipated profits.
 - (b) Quantities in excess of 125% of the bid quantities, when the total dollar value of the unit price item exceeds 5% of the original Contract bid amount, will be paid for at a negotiated unit price based on costs that are demonstrated by Contractor and agreed to by the Commissioner. The negotiated unit price can be higher or lower than the Bid Unit Price. Quantities in excess of 125% of the bid quantities, when the total dollar value on any unit price item does not exceed 5% of the total value of the original Contract bid amount, will be paid at the bid unit price.
 - (c) Quantities below 75% of the bid quantities, when the total value of the unit price item exceeds 5% of the Contract Price at the time of bid, will be paid for at a negotiated unit price based on costs which are demonstrated by Contractor and agreed to by the Commissioner. The negotiated unit price can be higher or lower than the Bid Unit Price. Quantities below 75% of the bid quantities, when the total value on any unit price item does not exceed 5% of the total value of the Contract Price at the time of bid will be paid at the bid unit price.
 - (d) If the Commissioner and Contractor are unable to agree on a negotiated unit price, the Commissioner will determine a unit price, prepare a Contract Modification with the Work so priced, that Contractor will sign. Contractor may, however, timely dispute the amount of the unit price to the CPO under Section 3.4, "Contract Disputes."
- (2) Proposal Basis. If there are no unit prices for the changed Work, the payment may be based upon a price agreed to by the City and Contractor. The proposal submitted will be a starting point for negotiation between the City and Contractor. Contractor must submit any proposal for consideration for changed Work in writing, breaking down the Work to be done into segments of cost as follows:

- (a) Labor. For all hourly wage labor and hourly wage foremen in direct charge of the specific operations, Contractor will receive the prevailing rate of wage for every hour that the labor and foremen are actually engaged in the Work. No additional allowance or payment will be made for general superintendence. Contractor will receive the actual costs paid to, or in behalf of, workers for health and welfare benefits, pension fund benefits or other benefits, when the amounts are required by collective bargaining agreement or other employment contract generally applicable to the classes of labor employed on the Work. An amount not to exceed 30% of 3.2.6(A)(1)(a) above and an amount not to exceed 10% of 3.2.6(A)(1)(b) above will also be paid to Contractor.
- (b) Insurance and Payroll Taxes. Cost for property damage, liability, and worker's compensation insurance premiums, unemployment insurance contributions and social security taxes on the extra Work, to which an amount not to exceed 10% of the cost of these items will be added. Contractor must furnish satisfactory evidence of the rates paid for the insurance and taxes.
- (c) Materials. For materials accepted by the Commissioner and used as an integral part of finished Work, Contractor will receive the actual costs of the materials delivered on the job

(a)

CSLP General Terms and Conditions

site, including transportation charges that Contractor paid (exclusive of machinery rentals as set forth below), as shown by original receipted bills, to which 15% will be added to the first \$10,000.00 and 10% for any amounts over \$10,000.00.

- (d) Equipment. Number of proposed equipment hours multiplied by the rate as allowed by the latest revision of "Schedule of Average Equipment Ownership Expense With Operating Cost" as issued by IDOT, or in the AED Compilation of Rental Rates if equipment is to be rented, for the period that the machinery and equipment are to be used on the Work, to which no percent will be added. Where machinery and equipment are not listed in these schedules, then the rates will be determined by the Commissioner after reviewing all of Contractor's available records or other information concerning the expense of operating that type of equipment.
 - (e) Cost for Increase in Performance and Payment Bond. Contractor will furnish the Commissioner written documentation from the surety of the rate or rates applicable for additional bonding for this Contract. These rates will be applied to all the changes increasing or decreasing the Contract Price. No bonding costs will be allowed for Subcontractors. In the absence of written documentation from the surety, a percentage of the total change, as determined by the Commissioner, will be added or subtracted to cover the increase or decrease of the cost of the bond.
 - (f) When Work is to be performed by a Subcontractor, the proposal may include as administrative costs for Contractor an amount not to exceed 5% of the first \$10,000.00 and 1% of any amount over \$10,000.00 of the total approved costs of the Work. The Subcontractor, however, is not allowed any additional markup if it sublets its Work. The use of a Subcontractor requires the approval of the Chief Procurement Officer. All subcontracted costs must be supported by proposals from the Subcontractors performing the Work. The Contractor's Subcontractor's proposal must be broken down into its various parts of Work as described in items 3.2.6(A)(2)(a) through 3.2.6(A)(2)(d) above, or as required by the Commissioner.
- (3) Time and Material Basis. If the Commissioner and Contractor cannot agree on a price based on a proposal, the Work will be paid for on a time and material basis. Work that is done on a time and material basis will be paid for as follows:
- (a) Labor. For all hourly wage labor and hourly wage foremen in direct charge of the specific operations, Contractor will receive the prevailing rate of wage for every hour that the labor and foremen are actually engaged in the Work. No additional allowance or payment will be made for general superintendence.
 - (b) Contractor will receive the actual costs paid to, or in behalf of, workers for health and welfare benefits, pension fund benefits or other benefits, when the amounts are required by collective bargaining agreement or other employment contract generally applicable to the classes of labor employed on the Work.
 - (c) An amount not to exceed 30% of 3.2.6(A)(3)(a) above and an amount not to exceed 10% of 3.2.6(A)(3)(b) above will also be paid to Contractor.
 - (d) No payment will be made for labor performed on a time and material basis until Contractor has furnished the Commissioner with itemized statements of the labor cost as follows.
 - (A) Name, classification, date, daily hours, total hours, rate, and extension for each laborer and foreman.
 - (B) Certified payrolls or certified copies of them, pertinent to the Work for which payment is requested. The payroll records will contain the name, address and social security number of each employee, the employees correct classification, rate of pay, daily and weekly number of hours worked, itemized deductions made and actual wages paid.

(A)

General Terms and Conditions

The time and material bills will be audited and corrected against the certified payrolls. Falsification of the certified payroll is an offense punishable by law.

- (e) Insurance and Payroll Tax. For property damage, liability, and workers compensation insurance premiums, unemployment insurance contributions and social security taxes on the time and material Work, Contractor will receive the actual costs, to which 10% will be added. No payment will be made for insurance and payroll taxes until Contractor has furnished satisfactory evidence of the rate or rates paid for the insurance and tax.
- (f) Materials. For materials accepted by the Commissioner and used as an integral part of finished Work, Contractor will receive the actual costs of the materials delivered on the job site, including transportation charges paid by him (exclusive of machinery rentals as set forth below), as shown by original receipted bills, to which 15% will be added to the first \$10,000.00 and 10% for any amounts over \$10,000.00.
- (g) Contractor will be reimbursed for any materials used in the construction of the Work, such as sheeting, falsework, form lumber, burlap, or other materials for curing, etc., that are not integral part of the finished Work. The amount of reimbursement will be agreed upon in writing before the Work is begun and no percent will be added. The salvage value of the materials will be taken into consideration in the reimbursement agreed upon.
- (h) No payment will be made for material cost until Contractor has furnished itemized statements of the material costs, which must include:
 - (A) Quantities of materials, prices, and extension;
 - (B) Material transportation costs supported by receipted invoices; and
 - (C) Receipted invoices for all materials used. However, if materials used on the time and material Work are not specifically purchased for the Work but are taken from Contractor's stock, then in lieu of the invoices, Contractor will furnish an affidavit certifying that the materials were from Contractor's stock, that the quantity claimed was actually used, and that the price and transportation claimed represent the actual cost to Contractor. The price quoted for the material must be reasonable and acceptable as per the normal industry practice.
- (i) Equipment. Contractor will be paid for all machinery and equipment (other than small tools as currently defined by the Illinois Department of Transportation) used on the Work in accordance with the latest revision of "Schedule of Average Annual Equipment Ownership Expense with Operating Cost," as issued by the Illinois Department of Transportation, for the period that the machinery and equipment are in use on the Work, to which no percent will be added. Where machinery and equipment are not listed in this schedule, the rates will be determined by the Commissioner after reviewing all Contractor's available records or other information concerning the expense of operating that type of equipment. Where idle time for equipment is authorized by the Commissioner, it will be paid at a rate not to exceed 50% of the rates described above.
- (j) When equipment is rented, Contractor will receive actual rental cost as shown by original receipted bills to which 5% will be added.
- (k) No payment will be made for equipment unless designations, dates, daily hours, rental rates, and extensions for each unit of machinery and equipment are shown on the itemized statement of time and material Work.
- (l) Bond. The City will pay Contractor the actual increase in cost of Contractor's performance bond. Contractor will furnish from the bonding company written documentation of the rate or rates applicable for additional bonding for this Contract. These rate/rates will be applied to all the changes increasing or decreasing the Contract value. No bonding costs

CSLP General Terms and Conditions

will be allowed for Subcontractors. In the absence of written documentation from the bonding company, a percentage of the

total change, as determined by the Commissioner, will be added or subtracted to cover the increase or decrease of the cost of the bond.

(m) When Work is performed by Subcontractor, Contractor will receive as administrative costs an amount equal to 10% of the first \$10,000 and 5% of any amount over \$10,000 of the total approved costs of the Work. The Subcontractor, however, is not allowed any additional markup if it sublets its Work. The use of a Subcontractor will require the approval of the Commissioner. All subcontracted costs must be supported by invoices from the Subcontractors performing the Work. The Subcontractors' invoices must be submitted in the form described in items (1) through (4) above.

(n) Documentation. For additional Work performed on a time and material basis Contractor will each day submit to the Commissioner detailed and complete records of the labor, material, equipment, and other costs relating to any force account Work performed on the day the Work is performed. Contractor and the Commissioner will sign these daily extra Work reports.

(o) Base Contract Work on a Premium Time Basis.

(A) For Contract Work performed outside of regularly schedule working hours as defined by the Contract, premium time costs will be paid, only if expressly directed in writing by the Commissioner before Contractor begins the Work. Compensation, when authorized, will cover only the direct cost of the premium portion of the time involved and will be without any charge for insurance. No payment will be made for union fringe benefits on the premium portion of the time unless expressly required by union agreement. Taxes that are attributed to the premium portion of the time will be paid. If Contractor seeks to charge taxes, the Commissioner may require Contractor to supply verification that the employees' Social Security Tax, Federal Unemployment Tax, and State Unemployment Tax limits have not been exceeded.

(B) An amount equal to 7% of the sum of the premium portion of the work plus taxes will also be paid to Contractor to cover job site general conditions, overhead, and profit. All indirect costs are considered part of the overhead, including supervision, engineering, and other technical personnel.

(C) If Contractor enters into a subcontract, Contractor will be allowed an additional 2% of the Contractor's Subcontractor's premium time billing to cover Contractor's supervisory and related expense on subcontract operations. The Subcontractor is not allowed the additional 2% if it sublets its Work.

(D) Contractor must keep Daily Work Reports for the premium time hours signed by Contractor and the Commissioner. The reports must indicate the time of day when the Work was performed and wage rate differential that will be charged. Billings must reflect hours reported on Daily Work Reports.

(4) Changes on Lump Sum Contracts or Lump Sum Items in Unit Priced Contracts. All increases or decreases in the Work that is listed in the approved schedule of values will be priced, for the purpose of any change, based on the amounts stated for the Work in the approved schedule of values.

(5) All invoices for changed work. Contractor must submit all invoices for changed work within 45 days following completion of the changed work. Failure to provide a complete invoice for the changed work within that period, will authorize the Commissioner, to determine the final amount for the Contract Modification that may be awarded without Contractor's signature.

(6) **Miscellaneous.**

(4)

CSLP General Terms and Conditions

(a) For the purposes of this Section, any business entity which employs field labor and performs Contract Work on the job site is defined as a "Subcontractor." (This definition excludes suppliers/deliverers of materials.)

(b) When the extra Work involves only supply of material without any field labor at the job site, the supplier, for the purposes of this Section, will be considered a "Materials Subcontractor" and the mark up specified in Section 3.2.6(A)(3)(f), "Materials," will apply.

(c) Expenses incurred by the City. Upon written request of the Commissioner, Contractor will pay the costs related to the Work that are the responsibility of the City. Contractor will be reimbursed for the actual amount paid out to which will be added a markup as specified in Section 3.2.6(A)(3) above.

(B) Change Claims:

(1) If Contractor and Commissioner are unable to agree on the price and/or time extension in connection with a change, Contractor must, within 15 days of completing the changed work, provide written notice to the Commissioner of the amount of money and/or time extension sought by Contractor and the Contractual and factual basis for each. Contractor will designate the document Notice of Claim.

- (2) The Commissioner will, within 30 days from receipt of the Notice of Claim, respond by requesting a meeting with Contractor, making a written request for additional information from Contractor, including a general statement of the basis for the claim, the facts underlying the claim, the notice to the Commissioner of the change that gave rise to the claim, reference to the applicable Contract provisions, and all documentation that describes, relates to and supports the claim; taking other action to attempt to resolve the Notice of Claim, and/or advising Contractor in writing that it should file a claim under Section 3.4, "Contract Disputes." Any steps taken by the Commissioner to resolve the Notice of Claim will not exceed 60 days from receipt of the Notice of Claim unless Contractor agrees to an additional amount of time in writing.
- (3) If the Notice of Claim cannot be resolved as provided for in Section 3.2.6(B), "Change Claims," Contractor must follow the requirements of Section 3.4, "Contract Disputes."
- (4) If Contractor does not agree with the adjustment for time and/or money proposed by the Commissioner, Contractor must follow the procedures set out by the Contract to file a claim and/or dispute as provided in Section 3.4, "Contract Disputes." Failure to follow the procedures set out by the Contract to file a claim and/or dispute as provided in Section 3.4, "Contract Disputes," constitutes a waiver of the right to make a claim or file a Dispute with the CPO.

7. Night, Sunday and Holiday Work

Whenever Contractor is permitted to perform Work at night, or on Sundays or State or Federal holidays, or to vary the period of hours during which any work is carried on each day. Contractor must give written notice to the Commissioner, at least 24 hours in advance, so that proper inspection may be provided. The Work will be done under regulations to be furnished in writing by the Commissioner, and no extra compensation will be allowed therefore.

8. Acceleration

If progress falls behind the approved schedule, the Commissioner may direct and authorize Contractor, in writing, to perform premium time work. No additional compensation will be paid for such premium time work and the cost incurred for inspection and testing during the premium time work will be considered as "extra" inspection. Contractor must pay the City its costs for any additional inspection trip.

If conditions are encountered where Contractor is specifically directed and authorized in writing by the Commissioner to perform premium time work, on the original contract, to advance an already established completion date of an event or the project, or project milestone, Contractor will be compensated in accordance with Section 3.2.6(A)(3)(o).

CSLP General Terms and Conditions

When the premium time Work is performed by approved subcontractor, Contractor will receive a markup as specified in Section 3.2.6(A)(3)(o) of the Contract.

3.2.9. Liquidated Damages

Failure of the Contractor to reach Substantial Completion of the LED conversion Work under any Work Order within the completion time specified in the applicable Work Order Release will result in the incurrence by the City of additional construction and engineering costs, including but not limited to supervision and inspection, together with other tangible and intangible losses. Therefore, if any work shall remain uncompleted after the time specified for the Substantial Completion of the work or after any authorized extension of such stipulated time, the Contractor shall pay to the City the sum listed below for each and every day that such work remains uncompleted, and such moneys shall be paid as liquidated damages, not a penalty, to partially cover costs and losses by the City. Liquidated damages shall be assessed on a per-Work Order basis.

Completion of all LED conversion Work under any Work Order: \$ 8,000 per calendar day

Liquidated Damages for LED conversion Work will be capped at the value of the applicable Work Order. The City shall recover said liquidated damages by deducting the amount thereof out of any moneys due or that may become due, and if said moneys are insufficient to cover said damages, then the Contractor or the Surety shall pay the amount due.

Nothing herein contained shall be construed as limiting the right of the City to recover from the Contractor any and all amounts due or to become due, and any and all costs and expenses sustained by the City for improper performance hereunder, repudiation of the Contract by the Contractor, failure to perform or breach or breaches in any other respect, including but not limited to defective workmanship or materials.

The date for commencement of work will not be counted as a calendar day but each subsequent day thereafter from midnight to midnight will be counted as one calendar day and the last day counted will be the day on which the Contractor shall have completed and the Commissioner shall have accepted the entire work under this Contract.

If the City permits Contractor to continue to perform Work despite Contractor's failure to meet any LED conversion milestone date set forth in

the Contract, the action in no way constitutes a waiver by the City of any rights or remedies that exist under this Contract, at law, or in equity.

3.2.10. Ordering, Invoices, and Payment for Non-Construction Portions of the Project

1. Purchase Orders

Requests for work, services or goods in the form of a Purchase Order will be issued by the Department and sent to the Contractor to be applied against the Contract. The Contractor must not honor any order(s), perform work or services or make any deliveries of goods without receipt of a Purchase Order issued by the City of Chicago. Any work, services, or goods provided by the Contractor without a Purchase Order is made at the Contractor's risk. Consequently, in the event such Purchase Order is not provided by the City, the Contractor releases the City from any liability whatsoever to pay for any work, services, or goods provided without said Purchase Order.

Purchase Orders will indicate quantities ordered for each line item, unit/total cost, shipping address, delivery date, fund chargeable information, catalog information (if applicable), and other pertinent instructions regarding performance or delivery.

2. Invoices

If required by the Scope of Work / Detailed Specifications, original invoices must be sent by the Contractor to the Department to apply against the Contract. Invoices must be submitted in accordance with the mutually agreed upon time period with the Department. All invoices must be signed, dated and reference the City's Purchase Order number and Contract number. A signed work

CSLP General Terms and Conditions

ticket, time sheets, manufacturer's invoice, if applicable, or any documentation requested by the Commissioner must accompany each invoice. If a Contractor has more than one contract with the City, separate invoices must be prepared for each contract in lieu of combining items from different contracts under the same invoice. Invoice quantities, description of work, services or goods, unit of measure, pricing and/or catalog information must correspond to the items on the accepted Price List or Proposal Pages or of the Bid Documents. If invoicing Price List/Catalog items, indicate Price List/Catalog number, item number, Price List/Catalog date and Price List/Catalog page number on the invoice.

3.2.10.3. Payment

The City will process payment within sixty (60) calendar days after receipt of invoices and all supporting documentation necessary for the City to verify the satisfactory delivery of work, services or goods to be provided under this Contract.

Contractor may be paid, at the City's option, by electronic payment method. If the City elects to make payment through this method, it will so notify the Contractor, and Contractor agrees to cooperate to facilitate such payments by executing the City's electronic funds transfer form, available for download from the City's website at: <http://www.cityofchicago.org/content/dam/city/depts/fin/supp%20info/DirectDepositCityVendor.pdf>. The City reserves the right to offset mistaken or wrong payments against future payments.

The City will not be obligated to pay for any work, services or goods that were not ordered with a Purchase Order or that are non-compliant with the terms and conditions of the Contract Documents. Any goods, work, or services which fail tests and/or inspections are subject to correction, exchange or replacement at the cost of the Contractor.

11. Electronic Ordering and Invoices

The Contractor will cooperate in good faith with the City in implementing electronic ordering and invoicing, including but not limited to price lists/catalogs, purchase orders, releases and invoices. The electronic ordering and invoice documents will be in a format specified by the City and transmitted by an electronic means specified by the City. Such electronic means may include, but are not limited to, disks, e-mail, EDI, FTP, web sites, and third party electronic services. The City reserves the right to change the document format and/or the means of transmission upon written notice to the Contractor. Contractor will ensure that the essential information, as determined by the City, in the electronic document, corresponds to that information submitted by the Contractor in its paper documents. The electronic documents will be in addition to paper documents required by this Contract, however, by written notice to the Contractor, the City may deem any or all of the electronic ordering and invoice documents the official documents and/or eliminate the requirement for paper ordering and invoice documents.

12. City Right to Offset

The City may offset against any invoice from Contractor any costs incurred by the City as a result of event of default by Contractor under this Contract or otherwise resulting from Contractor's performance or non-performance under this Contract, including but not limited to any credits due as a result of over-billing by Contractor or overpayments made by the City. If the amount offset is insufficient to cover those costs, Contractor is liable for and must promptly remit to the City the balance upon written demand for it. This right to offset is in addition to and not a limitation of any other remedies available to the City.

13. Records

Upon request the Contractor must furnish to the City such information related to the progress, execution, and cost of the Services. All books and accounts in connection with this Contract must be open to inspection by authorized representatives of the City. The Contractor

must make these records available at reasonable times during the performance of the Services and will retain them in a safe place and must retain them for a period that is the longer of five (5) years or as required by relevant retention schedules after the expiration or termination of the Contract.

CSLP General Terms and Conditions

3.2.14. Audits

1. City's Right to Conduct Audits

The City may, in its sole discretion, audit the records of Contractor or its Subcontractors, or both, at any time during the term of this Contract or within five years after the Contract ends, in connection with the goods, work, or services provided under this Contract. Each calendar year or partial calendar year may be deemed an "audited period".

2. Recovery for Over-Billing

If, as a result of such an audit, it is determined that Contractor or any of its Subcontractors has overcharged the City in the audited period, the City will notify Contractor. Contractor must then promptly reimburse the City for any amounts the City has paid Contractor due to the overcharges and, depending on the facts, also some or all of the cost of the audit, as follows:

If the audit has revealed overcharges to the City representing less than 5% of the total value, based on the contract prices, of the goods, work, or services provided in the audited period, then the Contractor must reimburse the City for 50% of the cost of the audit and 50% of the cost of each subsequent audit that the City conducts;

If, however, the audit has revealed overcharges to the City representing 5% or more of the total value, based on the contract prices, of the goods, work, or services provided in the audited period, then Contractor must reimburse the City for the full cost of the audit and of each subsequent audit.

Failure of Contractor to reimburse the City in accordance with the foregoing is an event of default under this Contract, and Contractor will be liable for all of the City's costs of collection, including any court costs and attorneys' fees.

15. Subcontractor Payment Reports

The Contractor must report payments to Subcontractors on a monthly basis in the form of an electronic report. Upon the first payment issued by the City to the Contractor for services performed, on the first day of each month and every month thereafter, email and/or fax notifications will be sent to the Contractor with instructions to report payments to Subcontractors that have been made in the prior month. This information must be entered into the Certification and Compliance Monitoring System (C2), or whatever reporting system is currently in place, on or before the fifteenth (15th) day of each month.

Once the Contractor has reported payments made to each Subcontractor, including zero dollar amount payments, the Subcontractor will receive an email and/or fax notification requesting that they log into the system and confirm payments received.

All monthly confirmations must be reported on or before the twentieth (20th) day of each month. Contractor and Subcontractor reporting to the C2 system must be completed by the 25th of each month or payments may be withheld.

All contracts between the Contractor and its Subcontractors must contain language requiring the Subcontractors to respond to email and/or fax notifications from the City requiring them to report payments received from the Contractor.

Access to the Certification and Compliance Monitoring System (C2), which is a web-based reporting system, can be found at: <<https://chicago.mwdbe.com>>

(Note: This site works for reporting all Subcontractor payments regardless of whether they are MBE/WBE/DBE or non-certified entities.)

If a Subcontractor has satisfactorily performed in accordance with the requirements of the Contract, Contractor must pay Subcontractor for such work, services, or materials within seven (7) calendar days of Contractor receiving payment from the City. Failure to comply with the foregoing will be deemed an event of default.

16. Prompt Payment to Subcontractors

3.2.16.1. Incorporation of Prompt Payment Language in Subcontracts

CSLP General Terms and Conditions

Contractor must state the requirements of these Prompt Payment provisions in all Subcontracts and purchase orders. If Contractor fails to incorporate these provisions in all Subcontracts and purchase orders, the provisions of this Section are deemed to be incorporated in all Subcontracts and purchase orders. Contractor and the Subcontractors have a continuing obligation to make prompt payment to their respective Subcontractors. Compliance with this obligation is a condition of Contractor's participation and that of its Subcontractors on this Contract.

3.2.16.2. Payment to Subcontractors Within Seven Days

The Contractor must make payment to its Subcontractors within 7 days of receipt of payment from the City for each invoice, but only if the Subcontractor has satisfactorily provided goods or services or completed its work or services in accordance with the Contract Documents and provided the Contractor with all of the documents and information required of the Contractor. The Contractor may delay or postpone payment for a to a Subcontractor when the Subcontractor's work or materials do not comply with the requirements of the Contract Documents, the Contractor is acting in good faith, and not in retaliation for a Subcontractor exercising legal or contractual rights.

1. Reporting Failures to Promptly Pay

The City posts payments to prime contractors on the web at <http://webapps.cityofchicago.org/VCSearchWeb/org/citvofchicago/vcsearch/controller/payments/begin.do?agencyId=city>.

If the Contractor, without reasonable cause, fails to make any payment to its Subcontractors and material suppliers within 7 days after receipt of payment under a City contract, the Contractor shall pay to its Subcontractors and material suppliers, in addition to the payment due them, interest in the amount of 2% per month, calculated from the expiration of the 7-day period until fully paid.

In the event that a Contractor fails to make payment to a Subcontractor within the 7-day period required above, the Subcontractor may notify the City by submitting a report form that may be downloaded from the DPS website at: [http://www.cityofchicago.org/content/dam/citv/depts/dps/ContractAdministration/StandardFormsAgreements/Failure to Promptly Pay Fillable Form 3 2013.pdf](http://www.cityofchicago.org/content/dam/citv/depts/dps/ContractAdministration/StandardFormsAgreements/Failure%20to%20Promptly%20Pay%20Fillable%20Form%203%202013.pdf)

The report will require the Subcontractor to affirm that (a) its invoice to the Contractor was included in the payment request submitted by the contractor to the City and (b) Subcontractor has not, at the time of the report, received payment from the contractor for that invoice. The report must reference the payment (voucher) number posted on-line by the City in the notice of the payment to the contractor.

Subcontractors are hereby reminded that per Chapters 1-21, "False Statements," and 1-22, "False Claims," of the Municipal Code of Chicago, making false statements or claims to the City are violations of law and subject to a range of penalties including fines and debarment.

2. Whistleblower Protection

Contractor shall not take any retaliatory action against any Subcontractor for reporting nonpayment pursuant to this Sub-Section 3.2.16.2. Any such retaliatory action is an event of default under this Contract and is subject to the remedies set forth in Section 3.5 hereof, including termination. In addition to those remedies, any retaliatory action by a contractor may result in a contractor being deemed non-responsible for future City contracts or, if, in the sole judgment of the Chief Procurement Officer, such retaliatory action is egregious, the Chief Procurement Officer may initiate debarment proceedings against the contractor. Any such debarment shall be for a period of not less than one year.

3.2.16.3. Liquidated Damages for Failure to Promptly Pay

Much of the City's economic vitality derives from the success of its small businesses. The failure by contractors to pay their subcontractors in a timely manner, therefore, is clearly detrimental to the

CSLP General Terms and Conditions

City. Inasmuch as the actual damages to the City due to such failure are uncertain in amount and difficult to prove, Contractor agrees that the City may assess liquidated damages against contractors who fail to meet their prompt payment requirements. Such liquidated damages shall be assessed to compensate the City for any and all damage incurred due to the failure of the Contractor to promptly pay its subcontractors, and does not constitute a penalty. Any and all such liquidated damages collected by the City shall be used to improve the administration and outreach efforts of the City's Small Business Program.

4. Action by the City

Upon receipt of a report of a failure to pay, the City will issue notice to the contractor, and provide the contractor with an opportunity to demonstrate reasonable cause for failing to make payment within applicable period set forth in the Contract. The Commissioner, in his or her sole judgment, shall determine whether any cause for nonpayment provided by a contractor is reasonable. In the event that the contractor fails to demonstrate reasonable cause for failure to make payment, the City shall notify the contractor that it will assess liquidated damages. Any such liquidated damages will be assessed according to the following schedule:

- First Unexcused Report: \$50
- Second Unexcused Report: \$100
- Third Unexcused Report: \$250
- Fourth Unexcused Report: \$500

5. Direct Payment to Subcontractors By City

The City may notify the Contractor that payments to the Contractor will be suspended if the City has determined that the Contractor has

failed to pay any Subcontractor, employee, or workman, for work performed. If Contractor has not cured a failure to pay a Subcontractor, employee or workman within 10 days after receipt of such notice, the City may request the Comptroller to apply any money due, or that may become due, to Contractor under the Contract to the payment of such Subcontractors, workmen, and employees and the effect will be the same, for purposes of payment to Contractor of the Contract Price, as if the City had paid Contractor directly.

Further, if such action is otherwise in the City's best interests, the City may (but is not obligated to) request that the Comptroller make direct payments to Subcontractors for monies earned on contracts and the effect will be the same, for purposes of payment to Contractor of the Contract Price, as if the City had paid Contractor directly. The City's election to exercise or not to exercise its rights under this paragraph shall not in any way affect the liability of the Contractor or its sureties to the City or to any such Subcontractor, workman, or employee upon any bond given in connection with such Contract.

3.2.17. General Price Reduction - Automatic Eligibility for General Price Reductions

If at any time after the Bid Opening Date the Contractor makes a general reduction in the price of any goods, services or work covered by the Contract to its customers generally, an equivalent price reduction based on similar quantities and/or considerations shall apply to the Contract for the duration of the contract period (or until the price is further reduced). Such price reduction will be effective at the same time and in the same manner as the reduction in the price to customers generally.

For purpose of this provision, a general price reduction will mean any reduction in the price of an article or service offered (1) to Contractor's customers generally, or (2) in the Contractor's price schedule for the class of customers, i.e., wholesalers, jobbers, retailers, etc., which was used as the basis for bidding on this Contract. An occasional sale at a lower price, or sale of distressed merchandise at a lower price, would not be considered a general price reduction under this provision.

The Contractor must invoice at such reduced prices indicating on the invoice that the reduction is pursuant to the General Price Reduction provision of the Contract. The Contractor, in addition, must within 10 calendar days of any general price reduction notify the City of such reduction by letter. Failure to do so will be an event of default. Upon receipt of any such notice of a general price reduction all participating Departments will be duly notified by the City.

CSLP General Terms and Conditions

Failure to notify the City of a General Price Reduction is an event of default, and the City's remedies shall include a rebate to the City of any overpayments.

3.3. Compliance With All Laws

1. General

Contractor must observe and comply with all applicable federal, state, county and municipal laws, statutes, regulations, codes, ordinances and executive orders, in effect now or later and as amended whether or not they appear in the Contract Documents.

Provisions required by law, ordinances, rules, regulations, or executive orders to be inserted in the Contract are deemed inserted in the Contract whether or not they appear in the Contract.

Contractor must pay all taxes and obtain all licenses, certificates, and other authorizations required in connection with the performance of its obligations hereunder, and Contractor must require all Subcontractors to also do so. Failure to do so is an event of default and may result in the termination of this Contract.

2. Certification of Compliance with Laws

By entering into this Contract with the City, Contractor certifies to the best of its knowledge and belief that it, its principals and any subcontractors used in the performance of this contract, meet City requirements and have not violated any City or sister agency policy, codes, state, federal, or local laws, rules or regulations and have not been subject to any debarment, suspension or other disciplinary action by any government agency. Additionally, if at any time the contractor becomes aware of such information, it must immediately disclose it to the City.

3. Federal Affirmative Action

It is an unlawful employment practice for the Contractor (1) to fail or refuse to hire or to discharge any individual, or otherwise to discriminate against any individual with respect to his or her compensation, or the terms, conditions, or privileges of his or her employment, because of such individuals race, color, religion, sex, age, handicap or national origin; or (2) to limit, segregate, or classify his or her employees or applicants for employment in any way which would deprive or tend to deprive any individual of employment opportunities or otherwise adversely affect his or her status as an employee, because of such individuals race, color, religion, sex, age, handicap or national origin

Contractor must comply with The Civil Rights Act of 1964, 42 U.S.C. sec. 2000 et seq. (1988), as amended. Attention is called to: Exec. Order No. 11,246,30 Fed. Reg. 12,319 (1965), reprinted in 42 U.S.C. 2000(e) note, as amended by Exec. Order No. 11,375,32 Fed. Reg. 14,303 (1967) and by Exec. Order No. 12,086,43 Fed. Reg. 46,501 (1978); Age Discrimination Act, 42 U.S.C. sec. 61 01-61 06 (1988); Rehabilitation Act of 1973, 29 U.S.C. sec. 793-794 (1988); Americans with Disabilities Act, 42 U.S.C. sec. 12102 et seq.; and 41 C.F.R. Part 60 et seq. (1990); and all other applicable federal laws, rules, regulations and executive orders.

4. **Civil Rights Act of 1964, Title VI, Compliance With Nondiscrimination Requirements**

During the performance of this contract, the contractor, for itself, its assignees, and successors in interest (hereinafter referred to as the "contractor") agrees as follows:

3.3.4.1. Compliance with Federal Nondiscrimination Requirements

The contractor will comply with federal nondiscrimination laws, regulations, and authorities, as they may be amended from time to time ("Acts and Regulations"), which include:

- Title VI of the Civil Rights Act of 1964 (42 U.S.C. § 2000d et seq., 78 stat. 252), (prohibits discrimination on the basis of race, color, national origin);
- 49 CFR part 21 (Non-discrimination In Federally-Assisted Programs of The Department of Transportation-Effectuation of Title VI of The Civil Rights Act of 1964);

CSLP General Terms and Conditions

- Section 504 of the Rehabilitation Act of 1973, (29 U.S.C. § 794 et seq.), as amended, (prohibits discrimination on the basis of disability); and 49 CFR part 27;
- The Age Discrimination Act of 1975, as amended, (42 U.S.C. § 6101 et seq.), (prohibits discrimination on the basis of age);
- The Civil Rights Restoration Act of 1987, (PL 100-209), (Broadened the scope, coverage and applicability of Title VI of the Civil Rights Act of 1964, The Age Discrimination Act of 1975 and Section 504 of the Rehabilitation Act of 1973, by expanding the definition of the terms "programs or activities" to include all of the programs or activities of the Federal-aid recipients, sub-recipients and contractors, whether such programs or activities are Federally funded or not);
- Titles II and III of the Americans with Disabilities Act of 1990, which prohibit discrimination on the basis of disability in the operation of public entities, public and private transportation systems, places of public accommodation, and certain testing entities (42 U.S.C. §§ 12131 - 12189) as implemented by Department of Transportation regulations at 49 CFR parts 37 and 38;
- Executive Order 12898, Federal Actions to Address Environmental Justice in Minority Populations and Low-Income Populations, which ensures non-discrimination against minority populations by discouraging programs, policies, and activities with disproportionately high and adverse human health or environmental effects on minority and low-income populations;
- Executive Order 13166, Improving Access to Services for Persons with Limited English Proficiency, and resulting agency guidance, national origin discrimination under Title VI includes discrimination because of limited English proficiency (LEP). (70 Fed. Reg. at 74087 to 74100);
- Title IX of the Education Amendments of 1972, as amended, prohibits discrimination because of sex in education programs or activities (20 U.S.C. 1681 et seq);
- The Uniform Relocation Assistance and Real Property Acquisition Policies Act of 1970, (42 U.S.C. § 4601), (prohibits unfair treatment of persons displaced or whose property has been acquired because of Federal or Federal-aid programs and projects);
- Airport and Airway Improvement Act of 1982, (49 USC § 471, Section 47123), as amended, (prohibits discrimination based on race, religion, color, national origin, or sex in any activity carried out with a grant from the FAA).

2. **Non-discrimination**

The contractor, with regard to the work performed by it during the contract, will not discriminate on the grounds of race, color, or national origin in the selection and retention of subcontractors, including procurements of materials and leases of equipment. The contractor will not participate directly or indirectly in the discrimination prohibited by the Acts and the Regulations, including employment practices when the contract covers any activity, project, or program set forth in Appendix B of 49 CFR part 21 (Nondiscrimination in Federally-Assisted Programs of the US Department of Transportation).

3. **Solicitations for Subcontracts, Including Procurements of Materials and Equipment**

In all solicitations, either by competitive bidding, or negotiation made by the contractor for work to be performed under a subcontract, including procurements of materials, or leases of equipment, each potential subcontractor or supplier will be notified by the contractor of the contractor's obligations under this contract and the Acts and the Regulations relative to Non-discrimination on the grounds of race, color, or national origin.

4. **Information and Reports**

3.3.4.4.

CSLP General Terms and Conditions

The contractor will provide all information and reports required by the Acts, the Regulations, and directives issued pursuant thereto and will permit access to its books, records, accounts, other sources of information, and its facilities as may be determined by the City or applicable federal agency (e.g. Federal Aviation Administration, Federal Highway Administration, Federal Transit Authority, Transportation Security Administration, Department of Housing and Urban Development, etc.) providing funding to the City department(s) on this contract to be pertinent to ascertain compliance with such Acts, Regulations, and instructions. Where any information required of a contractor is in the exclusive possession of another who fails or refuses to furnish the information, the contractor will so certify to the sponsor or the federal agency, as appropriate, and will set forth what efforts it has made to obtain the information.

5. Sanctions for Noncompliance

In the event of a contractor's noncompliance with the Non-discrimination provisions of this contract, the City will impose such contract sanctions as it or the relevant federal funding agency may determine to be appropriate, including, but not limited to:

- A. Withholding payments to the contractor under the contract until the contractor complies; and/or
- B. Cancelling, terminating, or suspending a contract, in whole or in part.

6. Incorporation of Provisions

The contractor will include the provisions of above paragraphs 3.3.4.1, "Compliance With Regulations" through 3.3.4.6 "Incorporation of Provisions" in every subcontract, including procurements of materials and leases of equipment, unless exempt by the Acts, the Regulations and directives issued pursuant thereto. The contractor will take action with respect to any subcontract or procurement as the sponsor or the applicable federal agency may direct as a means of enforcing such provisions including sanctions for noncompliance. Provided, that if the contractor becomes involved in, or is threatened with litigation by a subcontractor, or supplier because of such direction, the contractor may request the sponsor to enter into any litigation to protect the interests of the sponsor. In addition, the contractor may request the United States to enter into the litigation to protect the interests of the United States.

3.3.5. Other Non-Discrimination Requirements 3.3.5.1. Illinois Human

Rights Act

1. Generally

Contractor must comply with the Illinois Human Rights Act, 775 ILCS 5/1-1 01 et seq., as amended and any rules and regulations promulgated in accordance therewith, including, but not limited to the Equal Employment Opportunity Clause, 44 Ill. Admin. Code 750 Appendix A.

Contractor must comply with the Public Works Employment Discrimination Act, 775 ILCS 10/0.01 et seq., as amended; and all other applicable state laws, rules, regulations and executive orders.

2. State of Illinois Equal Employment Opportunity Clause

In the event of the Contractor's non-compliance with the provisions of this Equal Employment Opportunity Clause or the Illinois Human Rights Act, the Contractor may be declared ineligible for future contracts or subcontracts with the State of Illinois or any of its political subdivisions or municipal corporations, and the contract may be cancelled or voided in whole or in part, and other sanctions or penalties may be imposed or remedies invoked as provided by statute or regulation. During the performance of this contract, the Contractor agrees as follows:

- A) That Contractor will not discriminate against any employee or applicant for employment because of race, color, religion, sex, sexual orientation, marital status, order of protection status, national origin or ancestry, citizenship status, age, physical or mental disability unrelated to ability, military status or an unfavorable discharge from military service; and, further, that

C5tP General Terms and Conditions

he or she will examine all job classifications to determine if minority persons or women are underutilized and will take appropriate affirmative action to rectify any underutilization.

- B) That, if Contractor hires additional employees in order to perform this contract or any portion of this contract, Contractor will determine the availability (in accordance with 44 Ill. Admin. Code Part 750) of minorities and women in the areas from which Contractor may reasonably recruit and Contractor will hire for each job classification for which employees are hired in a way that minorities and women are not underutilized.

- C) That, in all solicitations or advertisements for employees placed Contractor or on Contractor's behalf, Contractor will state

that all applicants will be afforded equal opportunity without discrimination because of race, color, religion, sex, sexual orientation, marital status, order of protection status, national origin or ancestry, citizenship status, age, physical or mental disability unrelated to ability, military status or an unfavorable discharge from military service.

D) That Contractor will send to each labor organization or representative of workers with which Contractor has or is bound by a collective bargaining or other agreement or understanding, a notice advising the labor organization or representative of the Contractor's obligations under the Illinois Human Rights Act and 44 Ill. Admin. Code Part 750. If any labor organization or representative fails or refuses to cooperate with the Contractor in Contractor's efforts to comply with the Act and this Part, the Contractor will promptly notify the Illinois Department of Human Rights and the City and will recruit employees from other sources when necessary to fulfill its obligations under the contract.

E) That Contractor will submit reports as required by 44 Ill. Admin. Code Part 750, furnish all relevant information as may from time to time be requested by the Illinois Department of Human Rights or the City, and in all respects comply with the Illinois Human Rights Act and 44 Ill. Admin. Code Part 750.

F) That Contractor will permit access to all relevant books, records, accounts and work sites by personnel of the City and the Illinois Department of Human Rights for purposes of investigation to ascertain compliance with the Illinois Human Rights Act and the Illinois Department of Human Rights's Rules and Regulations.

G) That Contractor will include verbatim or by reference the provisions of this clause in every subcontract awarded under which any portion of the contract obligations are undertaken or assumed, so that the provisions will be binding upon the subcontractor. In the same manner as with other provisions of this contract, the Contractor will be liable for compliance with applicable provisions of this clause by subcontractors; and further it will promptly notify the City and the Illinois Department of Human Rights in the event any subcontractor fails or refuses to comply with the provisions. In addition, the Contractor will not utilize any subcontractor declared by the Illinois Human Rights Commission to be ineligible for contracts or subcontracts with the State of Illinois or any of its political subdivisions or municipal corporations.

2. **Chicago Human Rights Ordinance MCC Ch. 2-160**

Contractor must comply with the Chicago Human Rights Ordinance, MCC Ch. 2-160, Sect. 2-160-010 et seq., as amended; and all other applicable municipal code provisions, rules, regulations and executive orders.

Contractor must furnish or shall cause each of its Subcontractors to furnish such reports and information as requested by the Chicago Commission on Human Relations.

3. **Business Enterprises Owned by People With Disabilities (BEPD)**

Pursuant to MCC 2-92-586, Contractor is strongly encouraged to subcontract with businesses certified as business enterprises owned or operated by people with disabilities ("BEPD") as defined in that section or MCC 2-92-337, and to use BEPD businesses as suppliers.

3.3.6. Wages

CSLP General Terms and Conditions

Contractor must pay the highest of (1) prevailing wage/Davis-Bacon rate, if applicable; (2) minimum wage specified by Mayoral Executive Order 2014-4; "Living Wage" rate specified by MCC Sect. 2-92-610; (3) Chicago Minimum Wage rate specified by MCC Chapter 1-24, or (4) the highest applicable State or Federal minimum wage.

1. **Minimum Wage, Mayoral Executive Order 2014-1**

Mayoral Executive Order 2014-1 provides for a fair and adequate Minimum Wage to be paid to employees of City contractors and subcontractors performing work on City contracts.

If this contract was advertised on or after October 1, 2014, Contractor must comply with Mayoral Executive Order 2014-1 and any applicable regulations issued by the CPO. The Minimum Wage to be paid pursuant to the Order as of July 1, 2016 is \$13.15 per hour. The Minimum Wage must be paid to:

All employees regularly performing work on City property or at a City jobsite.

All employees whose regular work entails performing a service for the City under a City contract.

Beginning on July 1, 2015, and every July 1 thereafter, the hourly wage specified by the Executive Order shall increase in proportion to the increase, if any, in the Consumer Price Index for All Urban Consumers most recently published by the Bureau of Labor Statistics of the United States Department of Labor. Any hourly wage increase shall be rounded up to the nearest multiple of ¹\$0.05. Such increase shall remain in effect until any subsequent adjustment is made. On or before June 1, 2015, and on or before every June 1 thereafter, the City shall make available to City Concessionaires a bulletin announcing the adjusted minimum hourly wages for the upcoming year.

The Minimum Wage is not required to be paid to employees whose work is performed in general support of contractors operations, does not directly relate to the services provided to the City under the contract, and is included in the contract price as overhead, unless that employee's regularly assigned work location is on City property or at a City jobsite. It is also not required to be paid by employers that are 501(c)(3) not-for-profits.

Except as further described, the Minimum Wage is also not required to be paid to categories of employees subject to subsection 4(a)(2), subsection 4(a)(3), subsection 4(d), subsection 4(e), or Section 6 of the Illinois Minimum Wage Law, 820 ILCS 105/1 et seq., in force as of the date of this Contract or as amended. Nevertheless, the Minimum Wage is required to be paid to those workers described in subsections 4(a)(2)(A) and 4(a)(2)(B) of the Illinois Minimum Wage Law.

Additionally, the Minimum Wage is not required to be paid to employees subject to a collective bargaining agreement that provides for different wages than those required by Mayoral Executive Order 2014-1, if that collective bargaining agreement was in force prior to October 1, 2014 or if that collective bargaining agreement clearly and specifically waives the requirements of the order.

If the payment a Base Wage pursuant to Municipal Code of Chicago Sect. 2-92-610 is required for work or services done under this Contract, and the Minimum Wage is higher than the Base Wage, then the Contractor must pay the Minimum Wage. Likewise, if the payment of a prevailing wage is required and the prevailing wage is higher than the Minimum Wage, then the Contractor must pay the prevailing wage.

Contractors are reminded that they must comply with Municipal Code Chapter 1-24 establishing a minimum wage.

2. Illinois Prevailing Wage Act/Davis-Bacon Act

This Contract calls for the construction of a "public work" within the meaning of Illinois Prevailing Wage Act, 820 ILCS 130/01 et seq. ("the Act"). The Act requires contractors and subcontractors to pay laborers, workers and mechanics performing services on public works projects no less than the current "prevailing rate of wages" (hourly cash wages plus amount for fringe benefits) in the county where the work is performed. The Department publishes the prevailing wage rates on its website at

CSLP General Terms and Conditions

<http://www.state.il.us/agency/idol/rates/rates.HTM>. The Department revises the prevailing wage rates and the contractor/subcontractor has an obligation to check the Department's web site for revisions to prevailing wage rates. For information regarding current prevailing wage rates, please refer to the Illinois Department of Labor's website. All contractors and subcontractors rendering services under this contract must comply with all requirements of the Act, including but not limited to, all wage requirements and notice and record keeping duties.

In the event that work under this Contract will be federally funded, the Contractor must ensure that it and its Subcontractors comply with the applicable provisions of the Davis-Bacon Act (prevailing wages), 40 U.S.C. sec 276, as amended, and the Copeland (anti-kickback) Act, 18 U.S.C. sec 874, and related regulations and pay such applicable prevailing wage rates. Prevailing wages are incorporated into the Contract by reference. Please refer to: <http://www.wdol.gov> for wage rates and more information. Additional or more detailed requirements may be set forth in another section of this Contract.

As a condition of making payment to the Contractor, the City may require the Contractor to submit an affidavit to the effect that not less than the prevailing hourly wage rate is being paid to laborers, mechanics, and other workmen employed on this Contract in accordance with federal law.

3.3.6.3. Living Wage Ordinance

MCC Sect. 2-92-610 provides for a living wage for certain categories of workers employed in the performance of City contracts, specifically non-City employed security guards, parking attendants, day laborers, home and health care workers, cashiers, elevator operators, custodial workers, and clerical workers ("Covered Employees"). Accordingly, pursuant to MCC Sect. 2-92-610 and regulations promulgated thereunder:

if the Contractor has 25 or more full-time employees, and if at any time during the performance of the contract the Contractor and/or any subcontractor or any other entity that provides any portion of the Services (collectively "Performing Parties") uses 25 or more full-time security guards, or any number of other full-time Covered Employees, then The Contractor's obligation to pay, and to assure payment of, the Base Wage will begin at any time during the Contract term when the conditions set forth in (1) and (2) above are met, and will continue thereafter until the end of the Contract term.

As of July 1, 2016 the Base Wage is \$12.15. The current rate can be found on the Department of Procurement Services' website.

Note: As of July 1, 2016, the wage specified by Mayoral Executive Order 2014-1 is higher than the Base Wage rate. Therefore, the higher wage specified by the Executive Order (or other applicable rule or law) must be paid.

Each July 1st the Base Wage will be adjusted, using the most recent federal poverty guidelines for a family of four (4) as published annually by the U.S. Department of Health and Human Services, to constitute the following: the poverty guidelines for a family of four (4) divided by 2000 hours or the current base wage, whichever is higher. At all times during the term of this Contract, Contractor and all other

Performing Parties must pay the Base Wage (as adjusted in accordance with the above). If the payment of prevailing wages is required for work or services done under this Contract, and the prevailing wages for Covered Employees are higher than the Base Wage, then the Contractor must pay the prevailing wage rates.

The Contractor must include provisions in all subcontracts requiring its Subcontractors to pay the Base Wage to Covered Employees. The Contractor agrees to provide the City with documentation acceptable to the CPO demonstrating that all Covered Employees, whether employed by the Contractor or by a subcontractor, have been paid the Base Wage, upon the City's request for such documentation. The City may independently audit the Contractor and/or subcontractors to verify compliance herewith.

CSLP General Terms and Conditions

Failure to comply with the requirements of this Section will be an event of default under this Contract, and further, failure to comply may result in ineligibility for any award of a City contract or subcontract for up to three years.

Not-for-Profit Corporations: If the Contractor is a corporation having Federal tax-exempt status under Section 501(c)(3) of the Internal Revenue Code and is recognized under Illinois not-for-profit law, then the provisions above do not apply.

3.3.6.4. Equal Pay

The Contractor will comply with all applicable provisions of the Equal Pay Act of 1963, 29 U.S.C. 206(d) and the Illinois Equal Pay Act of 2003, 820 ILCS 112/1, et seq., as amended, and all applicable related rules and regulations including but not limited to those set forth in 29 CFR Part 1620 and 56 Ill. Adm. Code Part 320.

3.3.7. Economic Disclosure Statement and Affidavit and Appendix A ("EDS")

Pursuant to MCC Ch. 2-154 and 65 ILCS 5/8-10-8.5 any person, business entity or agency submitting a bid or proposal to or contracting with the City of Chicago will be required to complete the Disclosure of Ownership Interests in the EDS. Failure to provide complete or accurate disclosure will render this Contract voidable by the City.

Contractors must complete an online EDS prior to the Bid Opening Date. Contractors are responsible for notifying the City and updating their EDS any time there is a change in circumstances that makes any information provided or certification made in an EDS inaccurate, obsolete or misleading. Failure to so notify the City and update the EDS is grounds for declaring the Contractor in default, terminating the Contract for default, and declaring the Contractor ineligible for future contracts.

Contractor makes certain representations and certifications that the City relies on in its decision to enter into a contract. The Laws and requirements that are addressed in the EDS include the following:

1. Business Relationships With Elected Officials MCC Sect. 2-156-030(b)

Pursuant to MCC Sect. 2-156-030(b), it is illegal for any elected official, or any person acting at the direction of such official, to contact either orally or in writing any other City official or employee with respect to any matter involving any person with whom the elected official has any business relationship that creates a financial interest on the part of the official, or the domestic partner or spouse of the official, or from whom or which he has derived any income or compensation during the preceding twelve months or from whom or which he reasonably expects to derive any income or compensation in the following twelve months. In addition, no elected official may participate in any discussion in any City Council committee hearing or in any City Council meeting or vote on any matter involving the person with whom the elected official has any business relationship that creates a financial interest on the part of the official, or the domestic partner or spouse of the official, or from whom or which he has derived any income or compensation during the preceding twelve months or from whom or which he reasonably expects to derive any income or compensation in the following twelve months.

Violation of MCC Sect. 2-156-030 by any elected official with respect to this contract will be grounds for termination of this contract. The term financial interest is defined as set forth in MCC Chapter 2-156.

2. MCC 1-23 and 720 ILCS 5/33E Bribery, Debts, and Debarment Certification

The Contractor or each joint venture partner, if applicable, must complete the appropriate subsections in the EDS which certify that the Contractor or each joint venture partner, its agents, employees, officers and any subcontractors (a) have not been engaged in or been convicted of bribery or attempted bribery of a public officer or employee of the City of Chicago, the State of Illinois, any agency of the federal government or any state or local government in the United States or engaged in or been convicted of bid-rigging or bid-rotation activities as defined in this section as required by the Illinois Criminal Code; (b) do not owe any debts to the State of Illinois, in accordance with 65 ILCS 5/11-42.1-1 and (c) are not presently debarred or suspended; Certification Regarding

CSLP General Terms and Conditions

Environmental Compliance; Certification Regarding Ethics and Inspector General; and Certification Regarding Court-Ordered Child

Support Compliance.

Contractor, in performing under this contract shall comply with MCC Sect. 2-92-320, as follows:

No person or business entity shall be awarded a contract or sub-contract if that person or business entity: (a) has been convicted of bribery or attempting to bribe a public officer or employee of the City of Chicago, the State of Illinois, or any agency of the federal government or of any state or local government in the United States, in that officers or employee's official capacity; or (b) has been convicted of agreement or collusion among bidders or prospective bidders in restraint of freedom of competition by agreement to bid a fixed price, or otherwise; or (c) has made an admission of guilt of such conduct described in (a) or (b) above which is a matter of record but has not been prosecuted for such conduct.

For purposes of this section, where an official, agent or employee of a business entity has committed any offense under this section on behalf of such an entity and pursuant to the direction or authorization of a responsible official thereof, the business entity will be chargeable with the conduct.

One business entity will be chargeable with the conduct of an affiliated agency. Ineligibility under this section will continue for three (3) years following such conviction or admission. The period of ineligibility may be reduced, suspended, or waived by the CPO under certain specific circumstances. Reference is made to Section 2-92-320 for a definition of affiliated agency, and a detailed description of the conditions which would permit the CPO to reduce, suspend, or waive the period of ineligibility.

3. Federal Terrorist (No-Business) List

Contractor warrants and represents that neither Contractor nor an Affiliate, as defined below, appears on the Specially Designated Nationals List, the Denied Persons List, the Unverified List, the Entity List, or the Debarred List as maintained by the Office of Foreign Assets Control of the U.S. Department of the Treasury or by the Bureau of Industry and Security of the U.S. Department of Commerce or their successors, or on any other list of persons or entities with which the City may not do business under any applicable law, rule, regulation, order or judgment.

"Affiliate" means a person or entity which directly, or indirectly through one or more intermediaries, controls, is controlled by or is under common control with Contractor. A person or entity will be deemed to be controlled by another person or entity if it is controlled in any manner whatsoever that results in control in fact by that other person or entity, either acting individually or acting jointly or in concert with others, whether directly or indirectly and whether through share ownership, a trust, a contract or otherwise.

4. Governmental Ethics Ordinance 2-156

Contractor must comply with MCC Ch. 2-156, Governmental Ethics, including but not limited to MCC Sect. 2-156-120 pursuant to which no payment, gratuity or offer of employment will be made in connection with any City contract, by or on behalf of a subcontractor to the prime Contractor or higher tier subcontractor or any person associated therewith, as an inducement for the award of a subcontract or order. Any contract negotiated, entered into, or performed in violation of any of the provisions of this Chapter will be voidable as to the City.

5. Lobbyists

Contractor must comply with Chapter 2-156 of the Municipal Code. Contractor acknowledges that any Agreement entered into, negotiated or performed in violation of any of the provisions of Chapter 2-156, including any contract entered into with any person who has retained or employed a non-registered lobbyist in violation of Section 2-156-305 of the Municipal Code is voidable as to the City.

3.3.8. EDS Update Obligation

CSLP General Terms and Conditions

Contractor is required to notify the City and update the EDS whenever there is a change in circumstances that makes any certification or information provided in an EDS inaccurate, obsolete or misleading. Failure to notify the City and update the EDS is grounds for declaring the Contractor in default, termination of the Contract for default, and declaring that the Contractor is ineligible for future contracts.

3.3.9. Restrictions on Business Dealings

1. Conflicts of Interest

The Contractor covenants that it presently has no interest and will not acquire any interest, direct or indirect, in any enterprise which would conflict in any manner or degree with the performance of the work, services or goods to be provided hereunder. The Contractor further covenants that in its performance of the Contract no person having any such interest shall be employed. If the City determines that the Contractor does have such a conflict of interest, the City will notify the Contractor in writing, stating the basis for its determination. The Contractor will thereafter have 30 days in which to respond with reasons why the Contractor believes a conflict of interest does not exist. If the Contractor does not respond or if the City still reasonably determines a conflict of interest to exist, the Contractor must terminate its interest in the other enterprise.

2. Prohibition on Certain Contributions, Mayoral Executive Order 2011-4

No Contractor or any person or entity who directly or indirectly has an ownership or beneficial interest in Contractor of more than 7.5% ("Owners"), spouses and domestic partners of such Owners, Contractor's Subcontractors, any person or entity who directly or indirectly has an ownership or beneficial interest in any Subcontractor of more than 7.5% ("Sub-owners") and spouses and domestic partners of such Sub-owners (Contractor and all the other preceding classes of persons and entities are together, the "Identified Parties"), shall make a contribution of any amount to the Mayor of the City of Chicago (the "Mayor") or to his political fundraising committee during (i) the bid or other solicitation process for this Contract or Other Contract, including while this Contract or Other Contract is executory, (ii) the term of this Contract or any Other Contract between City and Contractor, and/or (iii) any period in which an extension of this Contract or Other Contract with the City is being sought or negotiated.

Contractor represents and warrants that since the date of public advertisement of the specification, request for qualifications, request for proposals or request for information (or any combination of those requests) or, if not competitively procured, from the date the City approached the Contractor or the date the Contractor approached the City, as applicable, regarding the formulation of this Contract, no Identified Parties have made a contribution of any amount to the Mayor or to his political fundraising committee.

Contractor shall not: (a) coerce, compel or intimidate its employees to make a contribution of any amount to the Mayor or to the Mayor's political fundraising committee; (b) reimburse its employees for a contribution of any amount made to the Mayor or to the Mayor's political fundraising committee; or (c) bundle or solicit others to bundle contributions to the Mayor or to his political fundraising committee.

The Identified Parties must not engage in any conduct whatsoever designed to intentionally violate this provision or Mayoral Executive Order No. 2011-4 or to entice, direct or solicit others to intentionally violate this provision or Mayoral Executive Order No. 2011-4.

Violation of, non-compliance with, misrepresentation with respect to, or breach of any covenant or warranty under this provision or violation of Mayoral Executive Order No. 2011-4 constitutes a breach and default under this Contract, and under any Other Contract for which no opportunity to cure will be granted. Such breach and default entitles the City to all remedies (including without limitation termination for default) under this Contract, under Other Contract, at law and in equity. This provision amends any Other Contract and supersedes any inconsistent provision contained therein.

CSLP General Terms and Conditions

If Contractor violates this provision or Mayoral Executive Order No. 2011-4 prior to award of the Contract resulting from this specification, the CPO may reject Contractor's bid.

For purposes of this provision:

"Other Contract" means any agreement entered into between the Contractor and the City that is (i) formed under the authority of MCC Ch. 2-92; (ii) for the purchase, sale or lease of real or personal property; or (iii) for materials, supplies, equipment or services which are approved and/or authorized by the City Council.

"Contribution" means a "political contribution" as defined in MCC Ch. 2-156, as amended.

"Political fundraising committee" means a "political fundraising committee" as defined in MCC Ch. 2-156, as amended.

10. Debts Owed to the City; Anti-Scofflaw, MCC Sect. 2-92-380

In addition to the certifications regarding debts owed to the City in the EDS, Contractor is subject to MCC Sect. 2-92-380.

Pursuant to MCC Sect. 2-92-380 and in addition to any other rights and remedies (including set-off) available to the City under this Contract or permitted at law or in equity, the City will be entitled to set off a portion of the contract price or compensation due under the Contract, in an amount equal to the amount of the fines and penalties for each outstanding parking violation complaint and the amount of any debt owed by the contracting party to the City. For purposes of this section, outstanding parking violation complaint means a parking ticket, notice of parking violation, or parking violation complaint on which no payment has been made or appearance filed in the Circuit Court of Cook County within the time specified on the complaint, and debt means a specified sum of money owed to the City for which the period granted for payment has expired.

However no such debt(s) or outstanding parking violation complaint(s) will be offset from the contract price or compensation due under the contract if one or more of the following conditions are met:

the contracting party has entered into an agreement with the Department of Revenue, or other appropriate City department, for the payment of all outstanding parking violation complaints and debts owed to the City and the Contracting party is in compliance with the agreement; or

the contracting party is contesting liability for or the amount of the debt in a pending administrative or judicial proceeding; or the contracting party has filed a petition in bankruptcy and the debts owed the City are dischargeable in bankruptcy.

11. Other City Ordinances and Policies

1. False Statements

False statements made in connection with this Contract, including statements in, omissions from and failures to timely update the EDS, as well as in any other affidavits, statements or Contract Documents constitute a material breach of the Contract. Any such misrepresentation renders the Contract voidable at the option of the City, notwithstanding any prior review or acceptance by the City of any materials containing such a misrepresentation. In addition, the City may debar Contractor, assert any contract claims or seek other civil or criminal remedies as a result of a misrepresentation (including costs of replacing a terminated Contractor pursuant to MCC Sect. 1 -21-010.

2. **Multi Project Labor Agreement (PLA)**

The City has entered into the PLA with various trades regarding projects involving construction, demolition, maintenance, rehabilitation, and/or renovation work, as described in the PLA, a copy of which may be found on the City's website at: <http://www.cityofchicago.org/dam/city/depts/dps/RulesRegulations/Multi->ProjectLaborAgreement->

CSLP General Terms and Conditions

To the extent that this Contract involves a project that is subject to the PLA, Contractor acknowledges familiarity with the requirements of the PLA and its applicability to any Work under this Contract, and shall comply in all respects with the PLA.

3. **MBE/WBE Participation**

The City has set goals of 26% Minority Owned Business Enterprise (MBE) participation and 6% Women Owned Business Enterprise (WBE) participation on this Contract, as further described in Article 6. The Contractor will be expected to achieve these MBE/WBE participation goals on an annual basis, unless otherwise granted a waiver pursuant to Article 6.

4. **Asset Condition Assessment Hiring Requirements**

50% of the workers hired to perform the condition assessment required for the Infrastructure Stabilization portion of the Project must be:

- Individuals that are enrolled in, or have graduated from a Chicago Public Schools high school whose curriculum includes a Career & Technical Education (CTE) program -Municipal Code of Chicago 2-92-335. The proposed individual(s) must have been enrolled in the CTE program while attending said high school; or
- Individuals that are enrolled in, or have graduated from a construction technology training program administered by the City Colleges of Chicago - Municipal Code of Chicago 2-92-335; or
- Individuals that are currently participating in or have been a part of an Ex-Offender Apprentice Program - Municipal Code of Chicago 2-92-336.

5. **City Resident and Project Area Requirements**

For all LED Conversion and Infrastructure Stabilization Work (including the Asset Condition Assessment), Contractor will be required to comply with the minimum percentage of total worker hours performed by actual eligible residents of the City of Chicago as specified in MCC 2-92-330 and rules and regulations adopted thereunder. The Contractor will be expected to achieve these participation requirements on each Work Order assigned under the Contract, unless otherwise granted a waiver. 50% of the total work hours must be performed by City Residents unless the City determines otherwise. Additionally, at least 10% of the total work hours must be performed by persons who reside in socioeconomically disadvantaged areas as defined by the map provided in Exhibit 11, who shall be considered "Project Area Residents" for the purposes of this requirement. The map provided in Exhibit 11 is divided in two zones; half of the Project Area Residents work hours must be performed by residents of Zone A and half must be performed by residents of Zone B, as defined in the map provided in Exhibit 11, but work by residents of either zone may be performed throughout the City. Work hours performed by Project Area Residents will also be counted as work hours performed by City residents. In addition to complying with this requirement, Contractor and any Subcontractors must make good faith efforts to utilize qualified eligible residents of the City of Chicago in both unskilled and skilled labor positions.

A Contractor may request a reduction or waiver of these minimum percentage levels of Chicagoans and Project Area Residents as provided for in MCC 2-92-330 in accordance with standards and procedures developed by the City of Chicago's Chief Procurement Officer (CPO).

For purposes of these City resident hiring provisions:

"City Residents" means persons domiciled within the City of Chicago.

CSLP General Terms and Conditions

"Project Area Residents" for the purposes of this Project means persons who reside in socioeconomically disadvantaged areas as defined by the map provided in Exhibit 11. The map is divided into Zone A and Zone B.

"Domicile" means an individual's one and only true, fixed and permanent home and principal establishment.

"Eligible residents" means City Residents and Project Area Residents.

"Actual residents of the City of Chicago" shall mean persons domiciled within the City of Chicago. The domicile is an individual's one and only true, fixed and permanent home and principal establishment.

The Contractor shall provide for the maintenance of adequate employee residency records to ensure that actual eligible City Residents are employed on the project. The Contractor and subcontractors shall maintain copies of personnel documents supportive of every City Resident employee's actual record of residence.

Certified payroll reports (U.S. Department of Labor Form WH-347 or equivalent) must be submitted weekly to the Commissioner of the supervising City department, which clearly and accurately identifies the actual residence of every employee on each submitted certified payroll. The first time that an employee's name appears on a Certified payroll report, the date that the company hired the employee should be written in after the employee's name.

Full access to the Contractor's and subcontractors' employment records shall be granted to CPO, the Commissioner of the supervising City department, the Superintendent of the Chicago Police Department, the Chicago's Inspector General, or any duly authorized representative thereof. The Contractor and subcontractors shall maintain all relevant personnel data in records for a period of at least three years after final acceptance of the work.

At the direction of the supervising department, affidavits and other supporting documentation will be required of the Contractor to verify or clarify an employee's actual address when doubt or lack of clarity has arisen.

Unless a waiver has been granted by the City, good faith efforts on the part of the Contractor to provide utilization of actual Chicago residents will not be sufficient justification for failing to meet and document verified achievement of the minimum worker hours performed by actual Chicago residents.

Waiver requests will be considered based on the standards and procedures developed by the Chief Procurement Officer, "Regulations For Percentages Of City And Project Area Residents Worker Hours." However, waiver requests relating to the 10% Project Area Resident requirement will be addressed separately as 5% Zone A and 5% Zone B as well as an overall 10% requirement. Therefore, requests for a waiver relating to a zone must also include a showing that Contractor is unable to achieve 10% overall Project Area Resident work hours by hiring workers residing in the other zone.

When work associated with each Contract Work Order is completed, if the CPO has determined that the Contractor has failed to meet or adequately report the minimum worker hours performed by actual eligible Chicago residents, the City will thereby be damaged in the failure to provide the benefit of demonstrable employment to Chicagoans to the degree stipulated in this section. Therefore, in such a case of non-compliance it is agreed that 1/20 of 1 percent (.05%), 0.0005, of the final contract amount for the LED Conversion and Infrastructure Stabilization work for this contract

CSLP General Terms and Conditions

shall be surrendered by the Contractor to the City in payment for each percentage of shortfall toward the stipulated residency requirement. Failure to report the residency of employees entirely and / or correctly shall result in the surrender of the entire liquidated damages as if no Chicago residents were employed in either of the categories. The willful falsification of statements and/or Certified Payroll reports may subject the Contractor or subcontractors or employee to prosecution. Any retainage to cover contract performance that may become due to the Contractor may be withheld by the City pending the Chief Procurement Officer's determination of whether the Contractor must surrender damages as provided in this paragraph.

Nothing herein provided shall be construed to be a limitation upon the "Notice of Requirements for Affirmative Action to Ensure Equal Employment Opportunity, Executive Order 11246" and "Standard Federal Equal Employment Opportunity, Executive Order 11246," or other affirmative action required for equal opportunity under the provisions of this contract.

3.3.11.6. LED Conversion and Infrastructure Stabilization - Equal Employment Opportunity

Pursuant to section MCC 2-92-390, the City has adopted the following goals for employment of women and minorities on its construction contracts:

Type of worker	% of construction aggregated work hours performed by journeyworkers
Minority journeyworkers	25%
Women journeyworkers	7%

Type of worker	% of construction aggregated work hours performed by apprentices
Minority apprentices	25%
Women apprentices	7%

Type of worker	% of construction aggregated work hours performed by laborers
Minority laborers	40%
Women laborers	10%

CSLP General Terms and Conditions

Contractor has committed to hiring minorities and women to perform a percentage of the aggregated work hours on the project for the LED Conversion and Infrastructure Stabilization, as outlined in Exhibit 13. The Contractor will be expected to achieve these participation goals on each Work Order assigned under the Contract, unless otherwise granted a waiver. Contractor acknowledges that Contractor's failure to meet its specified utilization goals will result in the liquidated damages specified in Exhibit 13.

7. Union Apprenticeship Commitment

As part of its workforce development plan, Contractor has committed to sponsoring Union Local 9 apprentices to perform the LED Conversion and Infrastructure Stabilization Scopes of Work. Fifty percent (50%) of new hires brought on by Contractor or its Subcontractors for the LED Conversion and Infrastructure Stabilization Scopes of Work shall be sponsored Union Local 9 apprentices.

8. Licensing of General Contractors

Contractor acknowledges that the failure to comply with the provisions of Chapter 4-36 of the Municipal Code ("Chapter 4-36"), may result in inability to perform (or continue) to work, imposition of substantial fines, and/or in the City's revoking the Contractor's "general contractor" license. Information about Chapter 4-36 and application forms are available on the City's website, www.cityofchicago.org <<http://www.cityofchicago.org>>.

Contractor must be in compliance with the requirements of Chapter 4-36, in the appropriate license class commensurate with the size of this Project, if the license is required for the scope of work, throughout the term of the Contract.

Contractor's failure to be licensed as a "general contractor" at all times throughout the term of the Contract, if the license is required for the scope of work, is an event of default under the Contract and the City may exercise any and all rights and remedies permitted under the contract, at law, or in equity.

9. City Hiring Plan Prohibitions

- A. The City is subject to the June 16, 2014 "City of Chicago Hiring Plan" (the "2014 City Hiring Plan") entered in *Shakman v. Democratic Organization of Cook County*, Case No 69 C 2145 (United States District Court for the Northern District of Illinois).

Among other things, the 2014 City Hiring Plan prohibits the City from hiring persons as governmental employees in non-exempt positions on the basis of political reasons or factors.

- B. Contractor is aware that City policy prohibits City employees from directing any individual to apply for a position with Contractor, either as an employee or as a subcontractor, and from directing Contractor to hire an individual as an employee or as a Subcontractor. Accordingly, Contractor must follow its own hiring and contracting procedures, without being influenced by City employees. Any and all personnel provided by Contractor under this Contract are employees or Subcontractors of Contractor, not employees of the City of Chicago. This Contract is not intended to and does not constitute, create, give rise to, or otherwise recognize an employer-employee relationship of any kind between the City and any personnel provided by Contractor.
- C. Contractor will not condition, base, or knowingly prejudice or affect any term or aspect of the employment of any personnel provided under this Contract, or offer employment to any individual to provide services under this Contract, based upon or because of any political reason or factor, including, without limitation, any individual's political affiliation, membership in a political organization or party, political support or activity, political financial contributions, promises of such political support, activity or financial contributions, or such individual's political sponsorship or recommendation. For purposes of this Contract, a political organization or party is an identifiable group or entity that has as its primary purpose the support of or opposition to candidates for elected public office.

A.

CSLP General Terms and Conditions

Individual political activities are the activities of individual persons in support of or in opposition to political organizations or parties or candidates for elected public office.

- D. In the event of any communication to Contractor by a City employee or City official in violation of paragraph B above, or advocating a violation of paragraph C above, Contractor will, as soon as is reasonably practicable, report such communication to the Hiring Oversight Section of the City's Office of the Inspector General, and also to the head of the relevant City Department utilizing services provided under this Contract. Contractor will also cooperate with any inquiries by OIG Hiring Oversight.

10. **Inspector General**

It is the duty of any bidder, proposer or Contractor, all Subcontractors, every applicant for certification of eligibility for a City contract or program, and all officers, directors, agents, partners and employees of any bidder, proposer, Contractor, Subcontractor or such applicant to cooperate with the Inspector General in any investigation or hearing, if applicable, undertaken pursuant to MCC Ch. 2-56. Contractor understands and will abide by all provisions of MCC Ch. 2-56.

All subcontracts must inform Subcontractors of this provision and require understanding and compliance with them.

11. **Duty to Report Corrupt Activity**

Pursuant to MCC 2-156-018, it is the duty of the Contractor to report to the Inspector General, directly and without undue delay, any and all information concerning conduct which it knows to involve corrupt activity. "Corrupt activity" means any conduct set forth in Subparagraph (a)(1), (2) or (3) of Section 1-23-020 of the MCC. Knowing failure to make such a report will be an event of default under this Contract. Reports may be made to the Inspector General's toll free hotline, 866-IG-TIPUNE (866-448-4754).

12. **Clean Diesel Fleet MCC 2-92-595**

This Contract is for construction, demolition, restoration, repair, renovation, environmental remediation or environmental abatement of any building, structure, tunnel, excavation, roadway, bridge, transit station or parcel of land and the estimated value of this Contract is \$2,000,000 or more; accordingly:

- A. Contractor must comply with the Clean Diesel Contracting Ordinance, MCC Section 2-92-595.
- B. Contractor and any Subcontractor(s) must utilize Ultra Low Sulfur Diesel Fuel (ULSD) for any heavy-duty diesel-powered vehicle, non-road vehicle or non-road equipment used in the performance of the Contract.
- C. Contractor and any Subcontractor(s) must minimize idling of motor vehicles and non-road vehicles used in the performance of the Contract during periods of inactivity, and must comply with the anti-idling requirements imposed by any applicable federal, state, or local law.
- D. Contractor and any Subcontractor(s), may not use any of the following vehicles and equipment in the performance of the contract:
 - (i) any heavy-duty diesel vehicle not meeting or exceeding the US EPA's emission standards for heavy-duty diesel vehicles for the 1998 engine model year, unless such vehicle is fitted with a verified diesel emission control retrofit device; or
 - (ii) any non-road vehicle or non-road equipment not meeting or exceeding the US EPA's Tier 1 Non-road Diesel Standards, unless such vehicle or equipment is fitted with a verified diesel emission control retrofit device.

- E. Any heavy-duty diesel vehicles, non-road vehicles and non-road equipment used in the performance of this Contract must incorporate such engine or retrofit technology so that the Contractor, through such engine or retrofit technology used directly by the Contractor and all subcontractors, shall have a minimum of 2.1 clean fleet score per a reporting period, as

E.

CSLP General Terms and Conditions

calculated by using the methodology described in MCC subsection 2-92-595(c)(5). Contractor may exclude from the calculation of the clean fleet score all of the heavy-duty diesel vehicles, non-road vehicles and non-road equipment used in the performance of the contract during a reporting period that are owned or leased by any firm that the CPO has granted a clean fleet score annual waiver certificate pursuant to MCC subsection 2-92-595 (f).

- F. The City may conduct an audit of the Contractor or inspect any vehicle or equipment used in the performance of the Contract to ensure compliance with the requirements specified above. In the event that Contractor or any Subcontractor fails to utilize ULSD or fails to minimize idling or comply with anti-idling requirements, Contractor will be subject to liquidated damages of \$5,000 per day for each violation and each day of noncompliance will be a separate violation; provided, however, the damages will not exceed \$50,000 for any one vehicle or piece of equipment, as specified in MCC Section 2-92-595(e). Such liquidated damages are imposed not as a penalty but as an estimate of the damages that the City will sustain from delay in completion of the project and inspection and other enforcement costs, as well as the resultant damages to the public health of its citizens, which damages by their nature are not capable of precise proof. The City is authorized to withhold and deduct from monies otherwise payable to the contractor the amount of liquidated damages due to the City.

Contractor understands that pursuant to MCC subsection 2-92-595(e)(6), any person knowingly making a false statement of material fact to any City department with respect to compliance with the contract provisions specified in MCC subsection 2-92-595(e) Chicago may be fined not less than \$1,000 or more than \$5,000 for each statement.

13. **Electronic Mail Communication**

Electronic mail communication between Contractor and City employees must relate only to business matters between Contractor and the City.

14. **Wheel Tax (City Sticker)**

Contractor must pay all Wheel Tax required by Chapter 3-56 of the MCC, as amended from time to time. Contractor should take particular notice of MCC 3-56-020 and MCC 3-56-125 which relate to payment of the tax for vehicles that are used on City streets or on City property by City residents. For the purposes of Chapter 3-56, any business that owns, leases or otherwise controls a place of business within the City wherein motor vehicles or semi-trailers are stored, repaired, serviced, or loaded or unloaded in connection with the business is also considered to be a City resident.

15. **MacBride Principles Ordinance, MCC Sect. 2-92-580**

This law promotes fair and equal employment opportunities and labor practices for religious minorities in Northern Ireland and provide a better working environment for all citizens in Northern Ireland.

In accordance with MCC Sect. 2-92-580, if the primary Contractor conducts any business operations in Northern Ireland, it is hereby required that the Contractor will make all reasonable and good faith efforts to conduct any business operations in Northern Ireland in accordance with the MacBride Principles for Northern Ireland as defined in Illinois Public Act 85-1390 (1988 Ill. Laws 3220).

For those bidders who take exception in competitive bid contracts to the provision set forth above, the City will assess an eight percent (8%) penalty. This penalty will increase their bid price for the purpose of canvassing the bids in order to determine who is to be the lowest responsible bidder. This penalty will apply only for purposes of comparing bid amounts and will not affect the amount of any contract payment.

The provisions of this Section will not apply to contracts for which the City receives funds administered by the United States Department of Transportation (USDOT) except to the extent Congress has directed that USDOT not withhold funds from states and localities that choose to implement selective purchasing policies based on agreement to comply with the MacBride

CSLP General Terms and Conditions

Principles for Northern Ireland, or to the extent that such funds are not otherwise withheld by the USDOT.

12. **Compliance with the Americans with Disabilities Act and Other Laws Concerning Accessibility**

Contractor covenants that all designs, plans and drawings produced or utilized under this Contract will address and comply with all federal,

state and local laws and regulations regarding accessibility standards for persons with disabilities or environmentally limited persons including the following: the Americans with Disabilities Act of 1990, 42 U.S.C. § 12101 et seq. and the Americans with Disabilities Act Accessibility Guidelines for Buildings and Facilities ("ADAAG"); the Architectural Barriers Act, Pub. L. 90-480 (1968), and the Uniform Federal Accessibility Standards ("UFAS"); and the Illinois Environmental Barriers Act, 410 ILCS 25/1 et seq., and all regulations promulgated thereunder, see Illinois Administrative Code, Title 71, Chapter 1, Section 400.110. If the above standards are inconsistent, Contractor must assure that its designs, plans, and drawings comply with the standard providing the greatest accessibility. Also, Contractor must, prior to construction, review the plans and specifications to insure compliance with these standards. If Contractor fails to comply with the foregoing standards, the City may, without limiting any of its remedies set forth in this contractor or otherwise available at law, in equity or by statute, require Contractor to perform again, at no expense, all services required to be re-performed as a direct or indirect result of such failure.

13. **Compliance with Environmental Laws and Related Matters**

1. **Definitions**

For purposes of this section, the following definitions shall apply:

Environmental Agency: An Environmental Agency is any governmental agency having responsibility, in whole or in part, for any matter addressed by any Environmental Law. An agency need not be responsible only for matters addressed by Environmental Law(s) to be an Environmental Agency for purposes of this Contract.

Environmental.Claim: An Environmental Claim is any type of assertion that Contractor or any Subcontractor is liable, or allegedly is liable, or should be held liable, under any Environmental Law, or that Contractor or any Subcontractor has or allegedly has violated or otherwise failed to comply with any Environmental Law. A non-exhaustive list of Environmental Claims includes, without limitation: demand letters, lawsuits and citations of any kind regardless of originating source.

Environmental Law: An Environmental Law is any Law that in any way, directly or indirectly, in -whole or in part, bears on or relates to the environment or to human health or safety. A non-exhaustive list of Environmental Laws includes without limitation the Comprehensive Environmental Response, Compensation and Liability Act, 42 U.S.C. 9601, et seq., the Resource Conservation and Recovery Act, 42 U.S.C. 6901, et seq., the Hazardous Materials Transportation Act, 49 U.S.C. 5101, et seq., the Clean Air Act, 42 U.S.C. 7401, et seq., the Federal Water Pollution Control Act, 33 U.S.C. 1251, etseq., the Occupational Safety and Health Act, 29 U.S.C. 651, etseq., the Illinois Environmental Protection Act, 415 ILCS 5/1, et seq., the Illinois Occupational Safety and Health Act, 820 ILCS 219/1, etseq., Chapters 7-28 and 11-4 of the Chicago Municipal Code, and all related rules and regulations.

Law(s): The word "Law" or "Laws," whether or not capitalized, is intended in the broadest possible sense, including without limitation all federal, state and local: statutes; ordinances; codes; rules; regulations; administrative and judicial orders of any kind; requirements and prohibitions of permits, licenses or other similar authorizations of any kind; court decisions; common law; and all other legal requirements and prohibitions.

Routine: As applied to reports or notices, "routine" refers to a report or notice that must be made, submitted or filed on a regular, periodic basis (e.g., quarterly, annually, biennially) and that in no way arises from a spill or other release or any kind, or from an emergency response situation, or from any actual, possible or alleged noncompliance with any Environmental Law.

2. **Joint Ventures**

3.3.13.2.

CSLP General Terms and Conditions

If Contractor or any Subcontractor is a joint venture, then every party to every such joint venture is deemed a Subcontractor for purposes of this section, which is entitled "Compliance with Environmental Laws and Related Matters" and every subsection thereof.

3. **Compliance With Environmental Laws**

As part of or in addition to its obligation to observe and comply with all applicable laws, Contractor must observe and comply with all applicable Environmental Laws and ensure that all Subcontractors observe and comply with all applicable Environmental Laws.

Any noncompliance, by Contractor or any Subcontractor, with any Environmental Law during the time that this Contract is effective is an event of default, regardless of whether the noncompliance relates to performance of this Contract. This includes without limitation any failure by Contractor or any Subcontractor to keep current, throughout the term of this Contract, all insurance certificates, permits and other authorizations of any kind that are required, directly or indirectly, by any Environmental Law. When requested by the Commissioner, Contractor must submit copies of all permits and insurance certificates required by any Environmental Law.

4. **Costs**

Any cost arising directly or indirectly, in whole or in part, from any noncompliance, by Contractor or any Subcontractor, with any Environmental Law, will be borne by the Contractor and not by the City. This includes, but is not limited to, any cost associated with removal of waste or other material from a facility lacking any required permit. No provision of this Contract is intended to create or constitute an exception to this provision.

5. **Proof of Noncompliance; Authority; Cure**

Any adjudication, whether administrative or judicial, against Contractor or any Subcontractor, for a violation of any Environmental Law, is sufficient proof of noncompliance, and therefore of an event of default, for purposes of this Contract.

Any citation issued to/against Contractor or any Subcontractor, by any government agent or entity, alleging a violation of any Environmental Law, is sufficient proof of noncompliance for purposes of this Contract, and therefore of an event of default, if the citation contains or is accompanied by, or the City otherwise obtains, any evidence sufficient to support a reasonable conclusion that a violation has occurred.

Any other evidence of noncompliance with any Environmental Law is sufficient proof of noncompliance for purposes of this Contract, and therefore of an event of default, if the evidence is sufficient to support a reasonable conclusion that noncompliance has occurred.

The Commissioner shall have the authority to determine whether noncompliance with an Environmental Law has occurred, based on any of the foregoing types of proof. Upon determining that noncompliance has occurred, s/he may in his/her discretion declare an event of default and may in his/her discretion offer Contractor an opportunity to cure the event of default, such as by taking specified actions, which may include without limitation ceasing and desisting from utilizing a Subcontractor.

The Commissioner may consider many factors in determining whether to declare an event of default, whether to offer an opportunity to cure, and if so any requirements for cure, including without limitation: the seriousness of the noncompliance, any effects of the noncompliance, Contractor's and/or Subcontractor's history of compliance or noncompliance with the same or other Laws, Contractor's and/or Subcontractor's actions or inaction towards mitigating the noncompliance and its effects, and Contractor's or Subcontractor's actions or inaction towards preventing future noncompliance.

6. **Copies of Notices and Reports; Related Matters**

If any Environmental Law requires Contractor or any Subcontractor to make, submit or file any non-Routine notice or report of any kind, to any Environmental Agency or other person, including

CSLP General Terms and Conditions

without limitation any agency or other person having any responsibility for any type of emergency response activity, then Contractor must deliver a complete copy of the notice or report (or, in the case of legally required telephonic or other oral notices or reports, a comprehensive written summary of same) to the Law Department within 24 hours of making, submitting or filing the original report.

Additionally, to the extent not already achieved by Contractor's compliance with this paragraph 3.3.13.6 and paragraph 3.3.13.8, Contractor must notify the Commissioner of the Department, within 24 hours of learning of any of the following:

- (i) any release, suspected release, or threatened release of any waste or other material relating to the work performed under the Contract;
- (ii) any notice of any kind received by Contractor, any Subcontractor, or any employee or agent of Contractor or any Subcontractor, from an Environmental Agency or any other person, of or relating to any release, suspected release, or threatened release of any waste or other material relating to the work performed under the Contract.

This notification must be in writing, must be submitted by a fast method such as email, and must include, to the best of Contractor's knowledge at the time of submittal: the types and amounts of the waste or other material at issue; the location; the cause and any contributing factors; all actions taken, being taken, and intended to be taken by Contractor and any Subcontractors; and a copy of any notice received by Contractor, any Subcontractor, or any employee or agent of Contractor or any Subcontractor. Contractor must also provide written updates to the Commissioner by email or other method as indicated by the Commissioner whenever Contractor becomes aware of information that is different from or additional to the information provided in the initial notification.

The requirements of this provision apply, regardless of whether the subject matter of the required notice or report concerns performance of this Contract.

Failure to comply with any requirement of this provision is an event of default.

7. **Requests for Documents and Information**

If the Commissioner requests documents or information of any kind that directly or indirectly relate(s) to performance of this Contract, Contractor must obtain and provide the requested documents and/or information to the Commissioner within 5 business days.

Failure to comply with any requirement of this provision is an event of default.

8. **Environmental Claims and Related Matters**

Within 24 hours of receiving, or of any Subcontractor's receiving, notice of any Environmental Claim, Contractor must submit copies of all

documents constituting or relating to the Environmental Claim to the Law Department. Thereafter, Contractor must submit copies of related documents if requested by the Law Department. These requirements apply, regardless of whether the Environmental Claim concerns performance of this Contract.

Failure to comply with any requirement of this provision is an event of default.

9. **Preference for Recycled Materials**

To the extent practicable and economically feasible and to the extent that it does not reduce or impair the quality of any work or services, Contractor must use recycled products in performance of the Contract pursuant to U.S. Environment Protection Agency (U.S. EPA) guidelines at 40 CFR Parts 247-253, which implement section 6002 of the Resource Conservation and Recovery Act, as amended, 42 USC§6962.

10. **No Waste Disposal in Public Way MCC II-4-1600(E)**

Contractor warrants and represents that it, and to the best of its knowledge, its Subcontractors have not violated and are not in violation of the following sections of the Code (collectively, the Waste Sections):

CSLP General Terms and Conditions

- 7-28-390 Dumping on public way;
- 7-28-440 Dumping on real estate without permit;
- 11-4-1410 Disposal in waters prohibited;
- 11-4-1420 Ballast tank, bilge tank or other discharge;
- 11-4-1450 Gas manufacturing residue;
- 11-4-1500 Treatment and disposal of solid or liquid waste;
- 11-4-1530 Compliance with rules and regulations required;
- 11-4-1550 Operational requirements; and
- 11-4-1560 Screening requirements.

During the period while this Contract is executory, Contractor's or any Subcontractor's violation of the Waste Sections, whether or not relating to the performance of this Contract, constitutes a breach of and an event of default under this Contract, for which the opportunity to cure, if curable, will be granted only at the sole discretion of the CPO. Such breach and default entitles the City to all remedies under the Contract, at law or in equity.

This section does not limit the Contractor's and its Subcontractors' duty to comply with all applicable federal, state, county and municipal laws, statutes, ordinances and executive orders, in effect now or later, and whether or not they appear in this Contract.

Non-compliance with these terms and conditions may be used by the City as grounds for the termination of this Contract, and may further affect the Contractor's eligibility for future contract awards.

3.3.13.11. Handling, Recycling and Disposal of Waste and Materials

(A) Contractor is responsible for the proper handling, recycling and disposal of all materials, construction debris, soil, and other waste. Hauling, recycling and disposal by a Subcontractor does not relieve Contractor from responsibility for proper handling, recycling and disposal. Recycling and disposal of all materials, construction debris, soil and other wastes must be at a recycling or disposal site that is properly licensed and permitted to accept the particular materials, construction debris, soil and other wastes delivered to it in accordance with all Environmental Laws. Contractor must identify the waste or material handling site(s) to which Contractor has contractual access and for which proper permits and/or licenses have been obtained as described in Section 3.3.13.12., Waste & Material Handling, Recycling and Disposal Facilities.

(B) If the waste or material handling site the Contractor proposes to use does not possess the necessary permits and/or licenses to accept the materials, construction debris, soil or other wastes, Contractor must replace the waste or material handling site submitted as part of their proposal at no additional cost to the City. If Contractor disposes of materials, construction debris, soil, or other wastes at a site that is not properly permitted, Contractor will be responsible for all costs associated with the removal of the waste or material to a properly licensed/permitted facility.

(C) Contractor must notify the City of any community meetings, media involvement or media coverage related to the loading, hauling, recycling or disposal of materials, construction debris, soil, and other wastes under this Contract in which Contractor is asked to participate.

(D) Contractor must verify, in writing, whenever requested by the Commissioner, that all waste and materials Contractor accepts from the City have been handled, recycled and disposed of in compliance with all Environmental Laws.

(E) Contractor is prohibited from treating universal waste lamps for volume reduction under any conditions, including lamp crushing under 35 IAC 733.133(d)(3).

(F) Contractor must haul materials, construction debris, soil and other wastes in vehicles and/or containers complying with all applicable Environmental Laws. All equipment used to transfer

(A)

CSLP General Terms and Conditions

materials, construction debris, soil and other wastes must be designed to prevent spillage, leakage, or other release of any kind during the hauling operation. Contractor's and subcontractor's equipment must fully comply with all City, State and federal Regulations, laws and ordinances pertaining to size, load weight, safety and any Environmental Law.

12. **Waste & Material Handling, Recycling and Disposal Facilities**

The form for identifying Contractor's waste and material handling and disposal facilit(ies) and acknowledging terms and conditions relating thereto that Contractor has executed and attached to this Contract is incorporated by reference ("Affidavit" in Exhibit 12).

In addition to the representations and requirements contained in the Affidavit, Contractor acknowledges that unless otherwise authorized in writing by the City, the Contractor will not be permitted to continue to use a recycling/disposal/handling facility identified in the Affidavit that, (i) has been cited as being in violation of any environmental law or regulation or of any City ordinance; or (ii) does not have a necessary permit. If only one site was identified in the Form, Contractor must arrange for a substitute recycling/disposal/handling facility that meets the requirements specified in the Affidavit and provide a revised Affidavit to the Commissioner of CDOT. Contractor further acknowledges that any such substitution is at no additional cost to the City.

Contractor must also complete the form entitled "Contractor's Certification: Hazardous Waste" with each invoice submitted; a blank copy of this form is attached to this Contract as Exhibit 14.

13. **Waste Management Plan**

Contractor will be required to develop and submit a Waste Management Plan to the City for review within 15 calendar days prior to the start of work activities. The Plan shall include at minimum:

- (A) General: Provide an overall strategy for managing the waste materials and debris associated with the Project.
- (B) Meet or exceed the requirements of these specifications.
- (C) Waste Identification: Indicate anticipated types and quantities by volume and weight of waste generated by the Work. Include estimated quantities by volume and weight and assumptions for estimates.
- (D) Waste Reduction Plan: List each type of waste and whether it will be salvaged, recycled, or disposed. Include points of waste generation, total weight of each type of waste, final disposition for each waste type, and handling and transportation procedures.
 - (1) Salvaged Materials: For each type of material that is salvaged, describe the type of material, source, estimated quantity, and receiving entity. Include names, addresses, and telephone numbers for the receiving individuals and/or organizations.
 - (2) Recycled Materials: Indicate how and where materials will be recycled
 - (3) Disposed Materials: Indicate how and where materials will be disposed.
 - (4) Handling and Transportation Procedures: Include method that will be used for separating Salvaged, Recycled and Disposed Materials including sizes of containers, container labeling, and designated location on Site where materials separation will be located. Submit for review and approval a plan for waste identification, transportation, and recycling/disposal of materials 14 days prior to

(1)

transportation and disposal of materials from Site. Include relevant transporter and facility identification and regulatory classification and status, methods of transportation and disposal, contingency plans for spills during transportation, and schedule for transportation and disposal. Identify facility-specific requirements for waste profiling sampling and analyses to determine acceptance.

3.4. Contract Disputes

1. General

Compliance with the provisions in this Section 3.4, "Contract Disputes," is a precondition to seeking judicial review of an adverse decision of the CPO or his or her designated representative. Contractor must not withhold performance of and must prosecute any Work required by the Commissioner while Contractor's claim, including judicial resolution, if any, is pending. Contractor must prosecute all of its Work including any disputed Work with the same diligence and effort as if no dispute existed. Neither the CPO's determination (see Section 3.4.3, "Disputes," below), nor the continued performance by either party, constitutes an admission as to any factual and/or legal position in connection with the dispute or a waiver of any rights under the Contract.

2. Claims

- (1) This provision applies to all claims under this Contract, including those for time, money, or both.
- (2) Procedures. Within 14 days after a basis for claim arises, Contractor must submit its claim in writing to the City's project manager ("Commissioner's Representative"). This written claim to the Commissioner's Representative will constitute "notice" to the City for purposes of determining initial timeliness of the claim; oral notice is insufficient. If Contractor and the Commissioner's Representative are unable promptly (depending upon the complexity of the matter) to resolve the claim, Contractor must forward its claim in writing to the Commissioner together with the documents listed in (a) through (d) below (collectively, "Contractor's documents"). Contractor must include:
 - a) A general statement of the basis for the claim,
 - b) Reference to the applicable Contract provisions,
 - c) All records that support the claim, and
 - d) All documents that relate to it, such as correspondence, and that are reasonably necessary for the Commissioner's understanding to resolve the claim.

It is Contractor's responsibility to furnish your documents to the Commissioner at the time Contractor forwards the claim to him or her, as, with or without the supporting documentation, the Commissioner has 30 days to respond in writing to Contractor after he or she has received the claim. Incomplete information may result in an adverse response. The response may be in the form of a Contract Modification.

If within the 30 days the Commissioner neither responds nor forwards the claim to the CPO in lieu of responding, the claim will be considered denied, unless Contractor and the Commissioner have agreed to extend the time for him or her to complete his or her response. The Commissioner may, at his or her sole option, forgo the opportunity to respond directly to Contractor's claim by referring it with all Contractor's documentation and a Request for Resolution of Dispute to the CPO and supplying such additional documentation as the CPO may require of him or her.

3.4.3. Disputes

- (1) Invoking Dispute Resolution Procedures. If Contractor disputes the Commissioner's resolution or denial of its claim, or if Contractor's claim is deemed denied, Contractor has 10 days to

forward its claim and Contractor's documentation to the CPO indicating to him or her that Contractor is requesting resolution of a dispute and showing that Contractor has complied with the preceding claims procedures. Contractor's 10-day period to invoke dispute resolution by the CPO is counted from the date the Commissioner's written resolution was sent to Contractor, or, if he or she has not responded or forwarded the claim, from the date on which the time for the Commissioner's response lapsed.

Contractor must provide a general statement of the basis for its claim, the facts underlying the claim, reference to the applicable Contract provisions, and all documentation that describes, relates to and supports the claim. By submitting a Claim, Contractor certifies that:

- a) The Claim is made in good faith;

- b) The Claim's supporting data are accurate and complete to the best of the person's knowledge and belief;
 - c) The amount of the Claim accurately reflects the amount that the claimant believes is due from the City; and
 - d) The certifying person is duly authorized by the claimant to certify the Claim.
- (2) Waiver. If Contractor fails to file a Request for Resolution of Dispute with the CPO within the 10-day period Contractor will have waived its claim, the right to make the claim later, and the right to dispute its resolution or denial.
- (3) Dispute Procedures. Once the dispute resolution procedures are invoked, the CPO will proceed to a final and binding decision based upon the written submissions of parties. A copy of those rules and/or regulations is available through the Department of Procurement Services. The Chief Procurement Officer's decision will be implemented through a Contract Modification, if required, that will be made a part of the Contract with Contractor's signature or without it should Contractor refuse to sign the Contract Modification. If either Contractor or the Commissioner disagree(s) with the decision of the CPO, the exclusive remedy is judicial review by a common law writ of certiorari. Unless such review is sought within 35 days of receipt of the CPO decision, all rights to seek judicial review are waived.

3.5. Events of Default and Termination 3.5.1. Events of Default

In addition to any breach of contract and events of default described within the Contract Documents, the following constitute an event of default:

- A. Any material misrepresentation, whether negligent or willful and whether in the inducement or in the performance, made by Contractor to the City.
- B. Contractor's material failure to perform any of its obligations under this Contract including the following:
- C. Failure to perform the Services with sufficient personnel and equipment or with sufficient material to ensure the timely performance of the Services
- D. Failure to have and maintain all professional licenses required by law to perform the Services;
- E. Failure to timely perform the Services;
- F. Failure to perform the Services in a manner reasonably satisfactory to the Commissioner or the CPO or inability to perform the Services satisfactorily as a result of insolvency, filing for bankruptcy or assignment for the benefit of creditors;
- G. Failure to promptly re-perform, as required, within a reasonable time and at no cost to the City, Services that are rejected as erroneous or unsatisfactory;
- H. Discontinuance of the Services for reasons within Contractor's reasonable control;

A.

CSLP General Terms and Conditions

- I. Failure to update promptly EDS(s) furnished in connection with this Contract when the information or responses contained in it or them is no longer complete or accurate;
- J. Failure to comply with any other term of this Contract, including the provisions concerning insurance and nondiscrimination; and
- K. Any change in ownership or control of Contractor without the prior written approval of the City, which approval the City will not unreasonably withhold.
- L. Contractor's default under any other Contract it may presently have or may enter into with the City during the life of this Contract. Contractor acknowledges and agrees that in the event of a default under this Contract the City may also declare a default under any such other agreements.
- M. Contractor's repeated or continued violations of City ordinances unrelated to performance under the Contract that in the opinion of the Commissioner or the CPO indicate a willful or reckless disregard for City laws and regulations.
- N. Contractor's use of a subcontractor that is currently debarred by the City or otherwise ineligible to do business with the City.

2. Cure or Default Notice

The occurrence of any event of default permits the City, at the City's sole option, to declare Contractor in default.

The Commissioner shall give Contractor written notice of the default in the form of a cure notice ("Cure Notice") for all breaches which are susceptible to cure. The Commissioner may, in his or her sole discretion, give a default notice ("Default Notice") for those breaches which are not by their nature susceptible to cure.

If a Cure Notice is sent, the Commissioner will give Contractor an opportunity to cure the default within a specified period of time, which will

typically not exceed 30 Calendar Days unless extended by the Commissioner. The period of time allowed by the Commissioner to cure will depend on the nature of the event of default and the Contractor's ability to cure. In some circumstances the event of default may be of such a nature that it cannot be cured. Failure to cure within the specified time may result in a Default Notice to the Contractor.

Whether to issue the Contractor a Default Notice is within the sole discretion of the Commissioner and neither that decision nor the factual basis for it is subject to review or challenge under the Disputes provision of this Contract.

If the Commissioner issues a Default Notice, the Commissioner will also indicate any present intent the Commissioner may have to terminate this Contract. The decision to terminate is final and effective upon giving the notice. If the Commissioner decides not to terminate, this decision will not preclude the Commissioner from later deciding to terminate the Contract in a later notice, which will be final and effective upon the giving of the notice or on such later date set forth in the Default Notice.

When a Default Notice with intent to terminate is given, Contractor must discontinue any Services, unless otherwise directed in the notice.

3. Remedies

After giving a Default Notice, the City may invoke any or all of the following remedies:

- A. The right to take over and complete the Services, or any part of them, at Contractor's expense and as agent for Contractor, either directly or through others, and bill Contractor for the cost of the Services, and Contractor must pay the difference between the total amount of this bill and the amount the City would have paid Contractor under the terms and conditions of this Contract for the Services that were assumed by the City as agent for Contractor

CSLP General Terms and Conditions

- a. The City may use Contractor's Subcontractors, materials and equipment to complete the Work. If the City notifies Contractor that it is invoking this remedy, all rights Contractor may have in or under its subcontracts are assigned to the City, subject to the City's right to take assignment of all or only selected subcontracts, at the City's discretion.
 - b. The sole obligation accepted by the City under such subcontracts is to pay for Work satisfactorily performed after the date of the assignment. In the event a conditional assignment has not been executed, Contractor must execute, or cause to be executed, any assignment, agreement, or other document that may be necessary, in the sole opinion of the Corporation Counsel, to evidence or effect compliance with this provision. Contractor must promptly deliver such documents upon the City's request.
 - c. In the case of any subcontract so assigned and accepted by the City, Contractor remain liable to the Subcontractors for any payment already invoiced to and paid by the City, and for any claim, suit, or cause of action based on or resulting from any error, omission, negligence, fraud, willful or intentionally tortious conduct, or any other act or omission, or breach of Contract, by Contractor, its officers, employees, agents, and other Subcontractors, arising before the date of assignment to the City, when such claim, suit, or cause of action has not been discharged, disposed of, or otherwise resolved as of that date. Contractor must notify its Subcontractors of these requirements;
- B. The right to terminate this Contract as to any or all of the Services yet to be performed effective at a time specified by the City;
 - C. The right to seek specific performance, an injunction or any other appropriate equitable remedy;
 - D. The right to seek money damages;
 - E. The right to withhold all or any part of Contractor's compensation under this Contract;
 - F. The right to deem Contractor non-responsible in future contracts to be awarded by the City.

4. Non-Exclusivity of Remedies

The remedies under the terms of this Contract are not intended to be exclusive of any other remedies provided, but each and every such remedy is cumulative and is in addition to any other remedies, existing now or later, at law, in equity or by statute. No delay or omission to exercise any right or power accruing upon any event of default impairs any such right or power, nor is it a waiver of any event of default nor acquiescence in it, and every such right and power may be exercised from time to time and as often as the City considers expedient.

5. City Reservation of Rights

If the Commissioner considers it to be in the City's best interests, the Commissioner may elect not to declare default or to terminate this Contract. The parties acknowledge that this provision is solely for the benefit of the City and that if the City permits Contractor to continue to

provide the Services despite one or more events of default, Contractor is in no way relieved of any of its responsibilities, duties or obligations under this Contract, nor does the City waive or relinquish any of its rights.

6. Early Termination

The City may terminate this Contract, in whole or in part, at any time by a notice in writing from the City to the Contractor. The effective date of termination will be the date the notice is received by the Contractor or the date stated in the notice, whichever is later.

CSLP General Terms and Conditions

After the notice is received, the Contractor must restrict its activities, and those of its Subcontractors, to activities pursuant to direction from the City. No costs incurred after the effective date of the termination are allowed unless the termination is partial.

Contractor is not entitled to any anticipated profits on services, work, or goods that have not been provided. The payment so made to the Contractor is in full settlement for all services, work or goods satisfactorily provided under this Contract. If the Contractor disputes the amount of compensation determined by the City to be due Contractor, then the Contractor must initiate dispute settlement procedures in accordance with the Disputes provision.

If the City's election to terminate this Contract for default pursuant to the default provisions of the Contract is determined in a court of competent jurisdiction to have been wrongful, then in that case the termination is to be deemed to be an early termination pursuant to this Early Termination provision.

3.6. Department-specific Requirements

Contractor must comply with the relevant user Department's specific requirements in the performance of this Contract if applicable.

3.6.1. Department of Aviation Standard Requirements

For purposes of this section "Airport" refers to either Midway International Airport or O'Hare International Airport, which are both owned and operated by the City of Chicago.

1. Confidentiality of Airport Security Data

Contractor has an ongoing duty to protect confidential information, including but not limited to any information exempt from disclosure under the Illinois Freedom of Information Act such as information affecting security of the airport ("Airport Security Data"). Airport Security Data includes any Sensitive Security Information as defined by 49 CFR Part 1520. Contractor acknowledges that information provided to, generated by, or encountered by Contractor may include Airport Security Data. If Contractor fails to safeguard the confidentiality of Airport Security Data, Contractor is liable for the reasonable costs of actions taken by the City, the airlines, the Federal Aviation Administration ("FAA"), or the Transportation Security Administration ("TSA") that the applicable entity, in its sole discretion, determines to be necessary as a result, including without limitation the design and construction of improvements, procurement and installation of security devices, and posting of guards. All Subcontracts or purchase orders entered into by the Contractor, with parties providing material, labor or services to complete the Work, must contain the language of this section. If the Contractor fails to incorporate the required language in all Subcontracts or purchase orders, the provisions of this section are deemed incorporated in all Subcontracts or purchase orders.

2. Aviation Security

This Contract is subject to the airport security requirements of 49 United States Code, Chapter 449, as amended, the provisions of which govern airport security and are incorporated by reference, including without limitation the rules and regulations in 14 CFR Part 107 and all other applicable rules and regulations promulgated under them. All employees providing services at the City's airports must be badged by the City. (See Airport Security Badges.) Contractor, Subcontractors and the respective employees of each are subject to such employment investigations, including criminal history record checks, as the Administrator of the Federal Aviation Administration ("FAA"), the Under Secretary of the Transportation Security Administration ("TSA"), and the City may deem necessary. Contractor, Subcontractors, their respective employees, invitees and all other persons under the control of Contractor must comply strictly and faithfully with any and all rules, regulations and directions which the Commissioner, the FAA, or the TSA may issue from time to time may issue during the life of this Contract with regard to security, safety, maintenance and operation of the Airport and must promptly report any information regarding suspected violations in accordance with those rules and regulations.

CSLP General Terms and Conditions

Gates and doors that permit entry into restricted areas at the Airport must be kept locked by Contractor at all times when not in use or under Contractor's constant security surveillance. Gate or door malfunctions must be reported to the Commissioner without delay and must be kept under constant surveillance by Contractor until the malfunction is remedied.

3.6.1.3. Airport Security Badges

As part of airport operations and security, the Contractor must obtain from the airport badging office Airport Security Badges for each of its employees, subcontractors, material men, invitees or any person(s) over whom Contractor has control, which must be visibly displayed at all times while at the airport. No person will be allowed beyond security checkpoints without a valid Airport Security Badge. Each such person must submit signed and properly completed application forms to receive Airport Security Badges. Additional forms and tests may be required to obtain Airport Drivers Certification and Vehicle Permits. The application forms will solicit such information as the Commissioner may require in his or her discretion, including but not limited to name, address, date of birth (and for vehicles, driver's license and appropriate stickers). The Contractor is responsible for requesting and completing the form for each employee and subcontractor employee who will be working at the Airport and all vehicles to be used on the job site. Upon signed approval of the application by the Commissioner or his or her designee, the employee will be required to attend a presentation regarding airport security and have his or her photo taken for the badge. The Commissioner may grant or deny the application in his or her sole discretion. The Contractor must make available to the Commissioner, within one day of request, the personnel file of any employee who will be working on the project.

As provided in Aviation Security above, in order for a person to have an Airport Security Badge that allows access to the airfield or aircraft, a criminal history record check (CHRC) conducted by the Department of Aviation will also be required. The CHRC will typically include a fingerprint analysis by the Federal Bureau of Investigation and such other procedures as may be required by the TSA.

Airport Security Badges, Vehicle Permits and Drivers Licenses will only be issued based upon properly completed application forms. Employees or vehicles without proper credentials may be removed from the secured area and may be subject to fine or arrest. Contractor will be jointly and severally liable for any fines imposed on its employees or its Subcontractors employees.

In addition to other rules and regulations, the following rules related to Airport Security Badges, Vehicle Permits and Drivers Licenses must be adhered to:

- A. Each person must wear and display his or her Airport Security Badge on their outer apparel at all times while at the airport.
- B. All individuals operating a vehicle on the Aircraft Operations Area (AOA) must be familiar and comply with motor driving regulations and procedures of the State of Illinois, City of Chicago and the Department of Aviation. The operator must be in possession of a valid, State-issued Motor Vehicle Operators Driver's License. All individuals operating a vehicle on the AOA without an escort must also be in possession of a valid Aviation-issued Airport Drivers Permit.
- C. All operating equipment must have an Airport Vehicle Access Permit affixed to the vehicle at all times while operating on the Airport. All required City stickers and State Vehicle Inspection stickers must be valid.
- D. Individuals must remain within their assigned area and haul routes unless otherwise instructed by the Department of Aviation.
- E. The Contractors personnel who function as supervisors, and those that escort the Contractors equipment/operators to their designated work sites, may be required to obtain an added multi-area access designation on their personnel Airport Security Badge which must also be displayed while on the AOA.

A.

CSLP General Terms and Conditions

3.6.1.4. General Requirements Regarding Airport Operations

1. Priority of Airport Operations

Where the performance of the Contract may affect airport operation, the Contractor must cooperate fully with the Commissioner and his or her representatives in all matters pertaining to public safety and airport operation. Whether or not measures are specifically required by this Contract, the Contractor at all times must maintain adequate protection to safeguard aircraft, the public and all persons engaged in the work and must take such precaution as will accomplish such end, without interference with aircraft, the public, or maintenance and operations of the airport.

The Contractor's attention is drawn to the fact that airport facilities and infrastructure, including but not limited to runways, taxiways, vehicular roadways, loadways, loading aprons, concourses, holdrooms, gates, and passenger right-of-ways, are being used for scheduled and unscheduled civilian air transportation. Arrivals and departures are under the control of the FAA control tower(s). Use of the Airport for air transportation takes precedence over all of the Contractor's operations. No extra compensation will be allowed for any delays brought about by the operations of the Airport which require that Contractor's work must be interrupted or moved from one part of the work site to another.

2. Interruption of Airport Operations

If Contractor requires interruption of Airport facilities or utilities in order to perform work, Contractor must notify the Deputy Commissioner in charge of the project at least five (5) working days in advance of such time and must obtain the Deputy

Commissioner's approval prior to interrupting the service. Interruption of service must be kept to an absolute minimum, and to the extent practicable the work which occasions such interruptions must be performed in stages in order to reduce the time of each interruption. In case of interruptions of electrical services, service must be restored prior to sunset of the same day.

Prior to start of work, the Contractor must request of the Deputy Commissioner in charge of the project to provide specific requirements and instructions which are applicable to the particular work site areas, including, but not limited to, areas available for storage of any equipment, materials, tools and supplies needed to perform the work. Contractors must advise the Deputy Commissioner in charge of the project of the volume of equipment, materials, tools, and supplies that will be required in the secured areas of the airport in order to make arrangements for inspection of such equipment, materials, tools, and supplies at a security checkpoint.

3. Safeguarding of Airport Property and Operations

The Contractor must not permit or allow its employees, subcontractors, material men, invitees or any other persons over whom Contractor has control to enter or remain upon, or to bring or permit any equipment, materials, tools, or supplies to remain upon any part of the work site if any hazard to aircraft, threat to airport security, or obstruction of airport maintenance and operations, on or off the ground, would be created in the opinion of either the Commissioner or the Deputy Commissioner. Contractors must safeguard, and may be required to account for, all items brought beyond a security checkpoint, especially with respect to tools used in a terminal building.

4. Work on the Airfield

For any work on the airfield, between sunset and sunrise, any equipment and materials stored outside must be marked with red obstruction lights acceptable to the Commissioner and in conformity with all FAA requirements, including Advisory Circular 150/5345-43F. All obstruction lights must be kept continuously in operation between sunset and sunrise 7 days a week and also during any daylight periods when aircraft ceiling is below 500 feet and visibility is less than 5 miles. Information on ceiling and visibility may be obtained by the Contractor on request at the office of the Deputy Commissioner of Operations or from the FAA Control Tower

CSLP General Terms and Conditions

Operator. Proper compliance with these obstruction light requirements is essential to the protection of aircraft and human life and the Contractor has the responsibility of taking the initiative at all times to be aware of ceiling and visibility conditions, without waiting for the FAA Control Tower Operator or any other City representative to ask the Contractor to post obstruction lights.

For any work on the airfield, the Contractor must furnish aircraft warning flags, colored orange and white, in two sizes, one size 2' x 3' for hand use, and one size 3' x 5'. Each separate group or individual in all work areas, regardless of whether or not near runways, taxiways or aprons, must display a flag which must be maintained vertical at all times. Each truck or other piece of equipment of the Contractor must have attached to it, in a vertical and clearly visible position, a warning flag of the larger size. Except as otherwise agreed by the Commissioner or his or her designee, all cranes or booms used for construction work on the airfield must be lowered to ground level and moved 200 feet off the runways, taxiways and aprons during all hours of darkness and during all daylight hours when the aircraft ceiling is below the minimums specified in this section.

The Contractor acknowledges the importance of fully complying with the requirements of this section in order to protect aircraft and human life, on or off the ground. Failure on the part of the Contractor to perform the work in accordance with the provisions of this section and to enforce same with regard to all subcontractors, material men, laborers, invitees and all other persons under the Contractor's control is an event of default.

3.6.1.4.5. Parking Restrictions

Prior to commencing work, the Contractor must provide the Deputy Commissioner in charge of the project with an estimate of the number of vehicles that will require parking. Contractors are encouraged to provide employee parking elsewhere and shuttle their employees to the work site. The Department of Aviation may, but is not required to, provide parking areas for a limited number of vehicles in designated storage areas. All other vehicles must be parked in the public parking lots at the Airport, and there will be no reduced rate or complimentary parking for such vehicles. Employees must not, at any time, park their personal automobiles, no matter how short the duration, in any drive, road, or any other non-parking lot location at the airport. Such vehicles will be subject to immediate towing at the employees expense.

3.6.1.5. General Civil Rights (Airport and Airway Improvement Act of 1982, Section 520)

The contractor agrees that it will comply with pertinent statutes. Executive Orders and such rules as are promulgated to ensure that no person shall, on the grounds of race, creed, color, national origin, sex, age, or handicap be excluded from participating in any activity conducted with or benefiting from Federal assistance.

This provision binds the contractors from the bid solicitation period through the completion of the contract. This provision is in addition to that required of Title VI of the Civil Rights Act of 1964.

3.6.2. Emergency Management and Communications (OEMC) Security Requirements

1. Identification of Workers and Vehicles

All employees and vehicles working within O.E.M.C facilities must be properly identified. All vehicles and personnel passes will be issued to the Contractor by the Executive Director, as required. Contractor, Subcontractors, and employees must return identification material to the Executive Director upon completion of their respective work within the Project, and in all cases, the Contractor must return all identification material to the Executive Director after completion of the Project. Final Contract Payment will not be made until all passes issued have been returned to O.E.M.C Security.

2. Access to Facilities

For purposes of this section, "employee" refers to any individual employed or engaged by Contractor or by any Subcontractor. If the Contractor, or any employee, in the performance of this

CSLP General Terms and Conditions

City rjndrti

Contract, has or will have access to a Office of Emergency Management and Communications (O.E.M.C) facility, the City may conduct such background and employment checks, including criminal history record checks and work permit documentation, as the Executive Director of the Office of Emergency Management and Communications and the City may deem necessary, on the Contractor, any Subcontractor, or any of their respective employees. The Executive Director of the Office of Emergency Management and Communications has the right to require the Contractor to supply or provide access to any additional information the Executive Director deems relevant. Before beginning work on the project, Contractor must:

Provide the City with a list of all employees requiring access to enable the City to conduct such background and employment checks;

Deliver to the City consent forms signed by all employees who will work on the project consenting to the City's and the Contractor's performance of the background checks described in this Section; and

Deliver to the City consent forms signed by all employees who will require access to the O.E.M.C facility consenting to the searches described in this Section.

The Executive Director may preclude Contractor, any Subcontractor, or any employee from performing work on the project. Further, the Contractor must immediately report any information to the Executive Director relating to any threat to O.E.M.C infrastructure or facilities or the water supply of the City and must fully cooperate with the City and all governmental entities investigating the threat. The Contractor must, notwithstanding anything contained in the Contract Documents to the contrary, at no additional cost to the City, adhere, and cause its Subcontractors to adhere, to any security and safety guidelines developed by the City and furnished to the Contractor from time to time during the term of the Contract and any extensions of it.

Each employee whom Contractor wishes to have access to an O.E.M.C facility must submit a signed, completed "Area Access Application" to the O.E.M.C to receive a O.E.M.C Security Badge. If Contractor wishes a vehicle to have access to a O.E.M.C facility, Contractor must submit a vehicle access application for that vehicle. The applications will solicit such information as the Executive Director may require in his or her discretion, including name, address, date of birth (and for vehicles, driver's license and appropriate stickers). The Contractor is responsible for requesting and completing these forms for each employee who will be working at O.E.M.C facilities and all vehicles to be used on the job site. The Executive Director may grant or deny the application in his or her sole discretion. The Contractor must make available to the Executive Director, within one (1) day of request, the personnel file of any employee who will be working on the project.

At the Executive Director's request, the Contractor and Subcontractor must maintain an employment history of employees going back five years from the date Contractor began Work or Services on the project. If requested, Contractor must certify that it has verified the employment history as required on the form designated by the Executive Director. Contractor must provide the City, at its request, a copy of the employment history for each employee. Employment history is subject to audit by the City.

3.6.2.3. Security Badges and Vehicle Permits

O.E.M.C Security Badges and Vehicle Permits will only be issued based upon properly completed Area Access Application Forms. Employees or vehicles without proper credentials will not be allowed on O.E.M.C property.

The following rules related to Security Badges and Vehicle Permits must be adhered to:

- A. Each employee must wear and display the O.E.M.C Security Badge issued to that employee on his or her outer apparel at all times.

- B. At the sole discretion of the Executive Director and law enforcement officials, including but not limited to the Chicago Police Department, Cook County Sheriffs Office, Illinois State

A.

CSLP General Terms and Conditions

Police or any other municipal, state or federal law enforcement agency, all vehicles (and their contents) are subject to interior and/or exterior inspection entering or exiting O.E.M.C facilities, and all employees and other individuals entering or exiting O.E.M.C facilities are subject to searches. Vehicles may not contain any materials other than those needed for the project. The Executive Director may deny access to any vehicle or individual in his or her sole discretion.

- C. All individuals operating a vehicle on O.E.M.C property must be familiar and comply with motor driving regulations and procedures of the State of Illinois and the City of Chicago. The operator must be in possession of a valid, state-issued Motor Vehicle Operator's Driver License.
- D. All required City stickers and State Vehicle Inspection stickers must be valid.
- E. Individuals must remain within their assigned area and haul routes unless otherwise instructed by the City.
- F. Access to the Work sites will be as shown or designated on the Contract Documents Drawings or determined by the Executive Director. The Executive Director may deny access when, in his or her sole discretion, the vehicle or individual poses some security risk to O.E.M.C.

4. Gates and Fences

Whenever the Contractor receives permission to enter O.E.M.C property in areas that are exit/entrance points not secured by the City, the Contractor may be required to provide gates that comply with O.E.M.C design and construction standards. Contractor must provide a licensed and bonded security guard, subject to the Executive Director's approval and armed as deemed necessary by the Executive Director, at the gates when the gates are in use. O.E.M.C Security will provide the locks. Failure to provide and maintain the necessary security will result in an immediate closure by O.E.M.C personnel of the point of access.

Stockpiling materials and parking of equipment or vehicles near O.E.M.C security fencing is prohibited.

Any security fencing, gates, or alarms damaged by the Contractor or its Subcontractors must be manned by a licensed and bonded security guard of the Contractor at Contractor's expense until the damaged items are restored. Contractor must restore them to their original condition within an eight (8) hour period from the time of notice given by the Executive Director.

Temporary removal of any security fencing, gate or alarm to permit construction must be approved by the Executive Director, and Contractor must man the site by a licensed and bonded security guard, approved by and armed as deemed necessary by the Executive Director, at Contractor's expense, on a twenty-four (24) hour basis during the period of temporary removal. Contractor must restore the items removed to their original condition when construction is completed.

5. Hazardous or Illegal Materials

Unauthorized hazardous or illegal materials, including but not limited to hazardous materials as defined in 49 C.F.R. Parts 100-185 (e.g. explosives, oxidizers, radiological materials, infectious materials), contraband, firearms and other weapons, illegal drugs and drug paraphernalia, may not be taken on O.E.M.C property. Alcoholic beverages are also prohibited.

3.6.3. Chicago Police Department Security Requirements

As part of Police operations and security, the Contractor must obtain from the Police Department, Security Badges for each of its employees, subcontractors, material men, invitees or any person(s) over whom Contractor has control, which must be visibly displayed at all times while at any Police Department facility. No person will be allowed beyond security checkpoints without a valid Security Badge. Each such person must submit signed and properly completed application forms to receive Security Badges. The application forms will solicit such information as the Superintendent may require;

CSLP General Terms and Conditions

including but not limited to name, address, date of birth (driver's license). The Contractor is responsible for requesting and completing the form for each employee and subcontractors employee. The Superintendent may grant or deny the application in his or her sole discretion. The Contractor must make available to the Superintendent, within one (1) day of request, the personnel file of any employee who will be working on the project.

In addition to other rules and regulations, the following rules related to Security Badges, must be adhered to:

- A. Each person must wear and display his or her Security Badge on their outer apparel at all times while at any Chicago Police

Department facility.

- B. Individuals must remain within their assigned area unless otherwise instructed by the Chicago Police Department.

3.6.4. Department of Water Management ("DOWM") Security Requirements

1. Identification of Workers and Vehicles

All employees and vehicles working within DOWM facilities must be properly identified. All vehicles and personnel passes will be issued to the Contractor by the Commissioner, as required. Contractor, Subcontractors, and employees must return identification material to the Commissioner upon completion of their respective work within the Project, and in all cases, the Contractor must return all identification material to the Commissioner after completion of the Project. Final Contract Payment will not be made until all passes issued have been returned to DOWM Security.

2. Access to Facilities

For purposes of this section, "employee" refers to any individual employed or engaged by Contractor or by any Subcontractor. If the Contractor, or any employee, in the performance of this Contract, has or will have access to a Department of Water Management (DOWM) facility, the City may conduct such background and employment checks, including criminal history record checks and work permit documentation, as the Commissioner of the Department of Water Management and the City may deem necessary, on the Contractor, any Subcontractor, or any of their respective employees. The Commissioner of the Department of Water Management has the right to require the Contractor to supply or provide access to any additional information the Commissioner deems relevant. Before beginning work on the project, Contractor must:

Provide the City with a list of all employees requiring access to enable the City to conduct such background and employment checks;

Deliver to the City consent forms signed by all employees who will work on the project consenting to the City's and the Contractor's performance of the background checks described in this Section; and

Deliver to the City consent forms signed by all employees who will require access to the DOWM facility consenting to the searches described in this Section.

The Commissioner may preclude Contractor, any Subcontractor, or any employee from performing work on the project. Further, the Contractor must immediately report any information to the Commissioner relating to any threat to DOWM infrastructure or facilities or the water supply of the City and must fully cooperate with the City and all governmental entities investigating the threat. The Contractor must, notwithstanding anything contained in the Contract Documents to the contrary, at no additional cost to the City, adhere, and cause its Subcontractors to adhere, to any security and safety guidelines developed by the City and furnished to the Contractor from time to time during the term of the Contract and any extensions of it.

3. Security Badges and Vehicle Permits

Each employee whom Contractor wishes to have access to a DOWM facility must submit a signed, completed "Area Access Application" to the DOWM to receive a DOWM Security Badge. If Contractor wishes a vehicle to have access to a DOWM facility, Contractor must submit a vehicle

CSLP General Terms and Conditions

access application for that vehicle. The applications will solicit such information as the Commissioner may require in his or her discretion, including name, address, date of birth (and for vehicles, driver's license and appropriate stickers). The Contractor is responsible for requesting and completing these forms for each employee who will be working at DOWM facilities and all vehicles to be used on the job site. The Commissioner may grant or deny the application in his or her sole discretion. The Contractor must make available to the Commissioner, within one (1) day of request, the personnel file of any employee who will be working on the project.

At the Commissioner's request, the Contractor and Subcontractor must maintain an employment history of employees going back five years from the date Contractor began Work or Services on the project. If requested, Contractor must certify that it has verified the employment history as required on the form designated by the Commissioner. Contractor must provide the City, at its request, a copy of the employment history for each employee. Employment history is subject to audit by the City.

DOWM Security Badges and Vehicle Permits will only be issued based upon properly completed Area Access Application Forms. Employees or vehicles without proper credentials will not be allowed on DOWM property.

The following rules related to Security Badges and Vehicle Permits must be adhered to:

- A. Each employee must wear and display the DOWM Security Badge issued to that employee on his or her outer apparel at all times.
- B. At the sole discretion of the Commissioner and law enforcement officials, including but not limited to the Chicago Police Department, Cook County Sheriffs Office, Illinois State Police or any other municipal, state or federal law enforcement agency, all vehicles (and

their contents) are subject to interior and/or exterior inspection entering or exiting DOWM facilities, and all employees and other individuals entering or exiting DOWM facilities are subject to searches. Vehicles may not contain any materials other than those needed for the project. The Commissioner may deny access to any vehicle or individual in his or her sole discretion.

- C. All individuals operating a vehicle on DOWM property must be familiar and comply with motor driving regulations and procedures of the State of Illinois and the City of Chicago. The operator must be in possession of a valid, state-issued Motor Vehicle Operator's Driver License.
- D. All required City stickers and State Vehicle Inspection stickers must be valid.
- E. Individuals must remain within their assigned area and haul routes unless otherwise instructed by the City.
- F. Access to the Work sites will be as shown or designated on the Contract Documents Drawings or determined by the Commissioner. The Commissioner may deny access when, in his or her sole discretion, the vehicle or individual poses some security risk to DOWM.

3.6.4.4. Gates and Fences

Whenever the Contractor receives permission to enter DOWM property in areas that are exit/entrance points not secured by the City, the Contractor may be required to provide gates that comply with DOWM design and construction standards. Contractor must provide a licensed and bonded security guard, subject to the Commissioner's approval and armed as deemed necessary by the Commissioner, at the gates when the gates are in use. DOWM Security will provide the locks. Failure to provide and maintain the necessary security will result in an immediate closure by DOWM personnel of the point of access.

Stockpiling materials and parking of equipment or vehicles near DOWM security fencing is prohibited.

General Terms and Conditions

Any security fencing, gates, or alarms damaged by the Contractor or its Subcontractors must be manned by a licensed and bonded security guard of the Contractor at Contractor's expense until the damaged items are restored. Contractor must restore them to their original condition within an eight (8) hour period from the time of notice given by the Commissioner.

Temporary removal of any security fencing, gate or alarm to permit construction must be approved by the Commissioner, and Contractor must man the site by a licensed and bonded security guard, approved by and armed as deemed necessary by the Commissioner, at Contractor's expense, on a twenty-four (24) hour basis during the period of temporary removal. Contractor must restore the items removed to their original condition when construction is completed.

3.6.4.5. Hazardous or Illegal Materials

Unauthorized hazardous or illegal materials, including but not limited to hazardous materials as defined in 49 C.F.R. Parts 100-185 (e.g. explosives, oxidizers, radiological materials, infectious materials), contraband, firearms and other weapons, illegal drugs and drug paraphernalia, may not be taken on DOWM property. Alcoholic beverages are also prohibited.

CSLP General Terms and Conditions

ARTICLE 4. TERMS FOR PROFESSIONAL SERVICES WITH WORK

1. Providing Services

The Contractor must not honor any verbal requests for Services or perform or bill for any Services without receipt of a written Purchase Order or Work Order Release issued by the Department. Any work performed by the Contractor without a written Purchase Order or Work Order Release is done at the Contractor's risk. Consequently, in the event a written Purchase Order or Work Order Release is not provided by the City, the Contractor releases the City from any liability whatsoever to pay for any work performed provided without a Purchase Order or Work Order Release.

2. Standard of Performance

Contractor must perform all Services required of it under this Contract with that degree of skill, care and diligence normally shown by a Contractor in the community performing services of a scope and purpose and magnitude comparable with the nature of the Services to be provided under this Contract. Contractor acknowledges that it may be entrusted with or may have access to valuable and confidential information and records of the City and with respect to that information only, Contractor agrees to be held to the standard of care of a fiduciary.

Contractor must ensure that all Services that require the exercise of professional skills or judgment are accomplished by professionals qualified and competent in the applicable discipline and appropriately licensed, if required by law. Contractor must provide the City copies of any such licenses. Contractor remains responsible for the professional and technical accuracy of all Services or Deliverables furnished, whether by Contractor or its Subcontractors or others on its behalf. All Deliverables must be prepared in a form and content satisfactory to the Department and delivered in a timely manner consistent with the requirements of this Contract.

If Contractor fails to comply with the foregoing standards, Contractor must perform again, at its own expense, all Services required to be re-performed as a direct or indirect result of that failure. Any review, approval, acceptance or payment for any of the Services by the City does not relieve Contractor of its responsibility for the professional skill and care and technical accuracy of its Services and Deliverables. This provision in no way limits the City's rights against Contractor either under this Contract, at law or in equity.

Contractor shall not have control over, or charge of, and shall not be responsible for, construction means, methods, schedules, or delays, or for safety precautions and programs in connection with construction work performed by others.

To the extent they exist, the City may furnish structural, mechanical, chemical, air, and water pollution and hazardous materials tests, and other laboratory and environmental tests, inspections, and reports required by law or by authorities having jurisdiction over any work, or reasonably requested by Contractor.

In the event Contractor's Services include any remodeling, alteration, or rehabilitation work, City acknowledges that certain design and technical decisions shall be made on assumptions based on available documents and visual observations of existing conditions.

1. Satisfactory Performance

The Contractor will perform or cause to be performed all Services required by the Contract in accordance with the terms and conditions of this Contract, in accordance with any federal, state and local laws, statutes, ordinances, regulations and standards applicable to this Contract, and to the satisfaction of the Commissioner. The Contractor must at all times act in the best interests of the City in the performance of the Services under this Contract, consistent with the professional and fiduciary obligations assumed by it in entering into this Contract and will assure timely and satisfactory rendering and completion of its Services, including but not limited to Deliverables.

2. **Qualified Personnel**

The Contractor must assure that all Services which require the exercise of professional skills or judgment must be accomplished by professionals qualified and competent in the applicable discipline and appropriately licensed, if required by law. The Contractor covenants with the City to furnish its best professional expertise and judgment in furthering the City's interests.

CSLP Terms for Professional Services With Work

3. **Efficiency**

The Contractor agrees to furnish efficient business administration and supervision to render and complete the Services at reasonable cost, if furnished on a time and material basis.

4. **Compatibility and Integration**

The Contractor must ensure that the Services, Deliverables, and other resources and materials (collectively, the "Provided Resources") that are provided by the Contractor to the City, incorporated by Contractor, or approved or recommended by Contractor for use by the City in connection with Services rendered, be fully compatible with, and must not materially and adversely affect, or be materially and adversely affected by each other or the other hardware, software, equipment, network components, systems, services and other resources that are owned or leased by, or licensed to the City, as of the date the Services are performed (collectively, "City Resources"). At all times, Contractor must cooperate and work as requested with the other services providers of the City to coordinate the development and the provision of Services with the services and systems of such other service providers.

Such coordination shall include:

- (i) facilitating with such other relevant service providers the timely resolution of all problems that may arise and impact the Services, regardless of the actual or suspected root-cause of such problems, and using all commercially reasonable efforts to obtain and maintain the active participation, cooperation, and involvement of such other services providers as is required for such problem resolution;
- (ii) providing information concerning any of all of the Provided Resources or the data, computing environment, and technology direction used in implementing and providing the Services;
- (iii) working with the City's other service providers in the implementation and integration of the Services with the City Resources in City's environment and the integration and interfacing of the services of such other service providers with the Services;
- (iv) providing reasonable access to and use of the Provided Resources; and
- (v) performing other reasonably necessary tasks in connection with the Services in order to accomplish the foregoing activities described in this sentence.

In the event of any dispute between the parties as to whether a particular service or function falls within the scope of services to be provided by the City's third-party providers (or by the City itself), or within the scope of Services to be provided by the Contractor, such particular service or function shall be considered to be a part of the Services hereunder if it is consistent with, and reasonably inferable to be within, the scope of Contractor work, as set forth in this Contractor, and it more reasonably would be associated with the scope for Contractor's work than with the scope of the services to be provided by such other service providers. If any of the foregoing requires the disclosure of any proprietary information or Confidential Information of Contractor to any third party, such third party shall be required to enter into a reasonable confidentiality agreement with the City, with terms substantially equivalent to those of this Contract regarding the protection of Confidential Information.

4.2.2. Failure to Comply

If Contractor fails to comply with the above standards, Contractor will perform again, at its own expense, any and all Services required to be performed again as a direct or indirect result of such failure. The duty to perform again is in addition to and not a limitation on any other remedies available to the City under this Contract, at law, or in equity.

4.3. Deliverables

In carrying out its Services, Contractor must prepare or provide to the City various Deliverables. "Deliverables" include work product, produced by Contractor, including but not limited to written reviews,

CSLP Terms for Professional Services With Work

reports, recommendations, charts, analysis, designs, plans, specifications, drawings, or other similar products.

The City may reject Deliverables that do not include relevant information or data, or do not include all documents or other materials specified in this

Contract or reasonably necessary for the purpose for which the City made this Contract. If the City determines that Contractor has failed to comply with the foregoing standards, the City has 30 days from the discovery to notify Contractor of its failure. If Contractor does not correct the failure within 30 days after receipt of notice from the City specifying the failure, then the City, by written notice, may treat the failure as a default of this Contract.

Partial or incomplete Deliverables may be accepted for review only when required for a specific and well-defined purpose for the benefit of the City and when consented to in advance by the City. Such Deliverables will not be considered as satisfying the requirements of this Contract and the City's acceptance of partial or incomplete Deliverables in no way relieves Contractor of its commitments under this Contract.

4. Additional Services

Additional Services means those Services which are within the general scope of Services of this Contract, but beyond the description of services in the Detailed Specifications and all services reasonably necessary to complete the Additional Services to the standards of performance required by this Contract. Any Additional Services requested by the Department require the approval by the City through a formal amendment pursuant to Section 3.1.4.9 of the Standard Terms and Conditions before Contractor is obligated to perform those Additional Services and before the City becomes obligated to pay for those Additional Services.

5. Timeliness of Performance

Contractor must provide the Services and Deliverables within the term and within the time limits required under this Contract, pursuant to Detailed Specifications or as specified in the applicable Work Order Release. Further, Contractor acknowledges that TIME IS OF THE ESSENCE and that the failure of Contractor to comply with the time limits may result in economic or other losses to the City.

Neither Contractor nor its agents, employees or Subcontractors are entitled to any damages from the City, nor is any party entitled to be reimbursed by the City, for damages, charges or other losses or expenses incurred by Contractor by reason of delays or hindrances in the performance of the Services, whether or not caused by the City.

4.5.1. Time for Completing Punch List

Contractor acknowledges that TIME IS OF THE ESSENCE IN CLOSING OUT THE WORK, and Contractor must begin work immediately after receipt of a list of minor miscellaneous or finishing work known as "Punch List Work." Contractor's failure or that of its Subcontractors to begin the Punch List work within three days of receipt of the Punch List is an event of default.

Contractor must diligently prosecute the Punch List work once begun and complete it within 30 days from receipt of the Punch List.

6. Suspension

The City may at any time request that Contractor suspend its Services, or any part of them, by giving 15 days prior written notice to Contractor or upon informal oral, or even no notice, in the event of emergency. No costs incurred after the effective date of such suspension are allowed. Contractor must promptly resume its performance of the Services under the same terms and conditions as stated in this Contractor upon written notice by the Commissioner and such equitable extension of time as may be mutually agreed upon by the Commissioner and Contractor when necessary for continuation or completion of Services. Any additional costs or expenses actually incurred by Contractor as a result of recommencing the Services must be treated in accordance with the compensation provisions of this Contract.

No suspension of this Contract is permitted in the aggregate to exceed a period of 45 days within any one year of this Contract. If the total number of days of suspension exceeds 45 days, Contract by written notice to the City may treat the suspension as an early termination of this Agreement under the "General Terms and Conditions."

CSLP Terms for Professional Services With Work

4.7. Personnel

1. Adequate Staffing

Contractor must, upon receiving a fully executed copy of this Contract, assign and maintain during the term of this Contract and any extension of it an adequate staff of competent personnel that is fully equipped, licensed as appropriate, available as needed, qualified and assigned to perform the Services. The level of staffing may be revised from time to time by notice in writing from Contractor to the City with a detailed explanation and/or justification only with prior written consent of the Commissioner, which consent the Commissioner will not withhold unreasonably. The City may also from time to time request that the Contractor adjust staffing levels to reflect workload and level of required Services or Additional Services.

2. Key Personnel

In selecting the Contractor for this Contract the City relied on the qualifications and experience of those persons identified by Contractor by name as performing the Services ("Key Personnel"). Contractor must not reassign or replace Key Personnel without the written consent of the Commissioner, which consent the Commissioner will not unreasonably withhold. The Commissioner may at any time in writing notify Contractor that the City will no longer accept performance of Services under this Contract by one or more Key Personnel. Upon that notice Contractor must immediately suspend the services of such person(s) and provide a replacement of comparable qualifications and experience who is acceptable to the Commissioner. Contractor's Key Personnel, if any, are identified in the Scope of Services / Detailed Specifications

portion of this Contract.

3. Salaries and Wages

Contractor and any subcontractors must pay all salaries and wages due all employees performing Services under this Contract unconditionally and at least once a month without deduction or rebate on any account, except only for those payroll deductions that are mandatory by law or are permitted under applicable law and regulations. If in the performance of this Contract Contractor underpays any such salaries or wages, the Comptroller for the City may withhold, out of payments due to Contractor, an amount sufficient to pay to employees underpaid the difference between the salaries or wages required to be paid under this Agreement and the salaries or wages actually paid these employees for the total number of hours worked. The amounts withheld may be disbursed by the Comptroller for and on account of Contractor to the respective employees to whom they are due. The parties acknowledge that this paragraph is solely for the benefit of the City and that it does not grant any third party beneficiary rights.

8. Ownership of Documents

Except as otherwise agreed to in advance by the Commissioner in writing, all Deliverables, data, findings or information in any form prepared or provided by Contractor or provided by City under this Contract are property of the City. During performance of its Services, Contractor is responsible for any loss or damage to the Deliverables, data, findings or information while in Contractor's or any Subcontractor's possession. Any such lost or damaged Deliverables, data, findings or information must be restored at Contractor's expense. If not restorable, Contractor must bear the cost of replacement and of any loss suffered by the City on account of the destruction. Notwithstanding the foregoing, Contractor shall retain all rights to its standard details and specifications and proprietary software, and nothing in this section shall be construed to be a transfer of rights which are not owned by Contractor.

9. Copyright Ownership and other Intellectual Property

Contractor and the City intend that, to the extent permitted by law, the Deliverables to be produced by Contractor at the City's instance and expense under this Contract are conclusively considered "works made for hire" within the meaning and purview of Section 101 of the United States Copyright Act, 17 U.S.C. §101 et seq., and that the City will be the sole copyright owner of the Deliverables and of aspects, elements and components of them in which copyright can subsist, and which are owned and transferable by, and of all rights to apply for copyright registration or prosecute any claim of infringement. To the extent that any Deliverable does not qualify as a "work made for hire", Contractor hereby irrevocably grants, conveys, bargains, sells, assigns, transfers and delivers to the City, its successors and assigns, all right, title and interest

CSLP Terms for Professional Services With Work

in and to the copyright and all U.S. and foreign copyright registrations, copyright applications and copyright renewals for them, and other intangible, intellectual property embodied in or pertaining to the Deliverables prepared for the City under this Contract and all goodwill relating to them, free and clear of any liens, claims or other encumbrances, to the fullest extent permitted by law. Notwithstanding the foregoing, and whether Deliverables qualify as a "work made for hire" or Contractor instead irrevocably assigns all intellectual property embodied in or pertaining to the Deliverables, Contractor shall retain all rights to its standard details and specifications and proprietary software, and nothing in this section shall be construed as a transfer of rights, which are not owned by Contractor. Contractor shall have no liability or duty whatsoever for any modification or change of the Deliverables or work, without Contractor's direct involvement and consent.

For the avoidance of doubt, Deliverables consisting solely of work product or intellectual property that existed prior to this Contract or not specifically created for the City are not considered Deliverables to be produced by Contractor at the City's instance and expense under this Contract. Nevertheless, with respect to such Deliverables, Contractor must provide such licenses to the City as may be needed to facilitate City's usage of the Deliverables, as contemplated under this Contract or applicable NTP. Work product that is specifically created for the City pursuant to this Contract, including intellectual property contained therein that did not exist prior to this Contract, shall be considered a Deliverable.

Contractor will, and will cause all of its Subcontractors, employees, agents and other persons within its control to, execute all documents and perform all acts that the City may reasonably request in order to assist the City in perfecting its rights in and to the copyrights relating to the Deliverables, at the sole expense of the City. Contractor warrants to the City, its successors and assigns, that, on the date of delivery, except as expressly stated otherwise in writing to the Commissioner or before that date: (a) Contractor will be the lawful owner of good and marketable title in and to the copyrights for the Deliverables it prepared, (b) Contractor will have the legal rights to fully assign the copyrights, (c) Contractor will not assign any copyrights and will not grant any licenses, exclusive or nonexclusive, to any other party (except pursuant to (3) below), (d) Contractor is not a party to any other agreements or subject to any other restrictions with respect to the Deliverables, (e) the Deliverables will be complete, entire and comprehensive within the standard of performance under Section 4.2 of this Contract, and (f) the Deliverables will constitute works of original authorship.

1. Patents

The Contractor must perpetually and irrevocably license to the City, at no cost, the patent in any invention, improvement, or discovery developed under this Contract and any patent rights to which the Contractor purchases ownership with funds provided to it under this Contract.

2. Indemnity

Without limiting any of its other obligations under this Contract and in addition to any other obligations to indemnify under this Contract, Contractor must, upon request by the City, indemnify, save, and hold harmless the City, and if this Contract is federally funded the Federal Government, and their respective officers, agents, and employees acting within the scope of their original duties against any liability, including costs and expenses, resulting from any willful or intentional violation by the Contractor of proprietary rights, copyrights, or right of privacy, arising out of the publication, translation, reproduction, delivery, use or disposition of any Deliverables furnished under the Contract.

10. Approvals

Whenever Contractor is required to obtain prior written approval, the effect of any approval that may be granted pursuant to Contractor's request is prospective only from the later of the date approval was requested or the date on which the action for which the approval was sought is to begin. In no event is approval permitted to apply retroactively to a date before the approval was requested.

11. Cooperation

Contractor must at all times cooperate fully with the City and act in the City's best interests in the performance of the Services under this Contract. If this Contract is terminated for any reason, or if it is to expire on its own terms, Contractor must make every effort to assure an orderly transition to another

CSLP Terms for Professional Services With Work

provider of the services, if any, orderly demobilization of its own operations in connection with the services, uninterrupted provision of services during any transition period and must otherwise comply with the reasonable requests and requirements of the City in connection with the termination or expiration.

12. Reimbursement for Travel

In the event that reimbursable travel is required for this contract and authorized by the City, any travel expenses will be reimbursed only in accordance with the then-current City of Chicago Travel Reimbursement Guidelines. The Guidelines may be downloaded from the Internet at: <<http://www.cityofchicago.org/Forms>>. The direct link is: <[http://www.cityofchicago.org/content/dam/city/depts/dps/ContractAdministration/Forms/CityofChicago> TravelGuidelines.pdf](http://www.cityofchicago.org/content/dam/city/depts/dps/ContractAdministration/Forms/CityofChicago%20TravelGuidelines.pdf).

13. Standard Working Hours

Pursuant to MCC Section 2-92-220 a standard working day consists of 8 hours for this Contract; shifts must be coordinated with the Department. No overtime or premium pay is allowed unless otherwise specified in the Detailed Specifications and authorized by the Commissioner.

14. Character of Workers

The Contractor must employ only competent and efficient workers and whenever, in the opinion of the City, any such worker is careless, incompetent, violates safety or security rules, obstructs the progress of the work or services to be performed under this Contract, acts contrary to instructions or acts improperly, or fails to follow the safety requirements of this Contract, the Contractor must, upon request of the City, discharge or otherwise remove such worker from the work or services to be performed under this Contract and must not use such worker again, except with the written consent of the City. The Contractor must not permit any person to work upon the work or services to be performed under this Contract or enter into any buildings connected therewith who is under the influence of intoxicating liquors or controlled substances.

15. Quality of Materials and Inspection

The City will have a right to inspect any material to be used in performance of the Services for this Contract.

The City is not responsible for the availability of any materials or equipment required under this Contract.

The Contractor is responsible for the meeting the contractual obligations and standards regarding the quality of all materials, components, or services performed under this Contract up to the time of final acceptance by the City.

Non-compliant materials, components, or Services may be rejected by the City and must be replaced or re-performed by the Contractor at no cost to the City.

The City shall provide written notice to the Contractor indicating the time period in which Contractor must, at its sole expense, remove from City premises, any materials or components rejected by the City.

Any and all labor and materials which may be required to correct or replace damaged, defective or nonconforming products must be provided by the Contractor at no cost to the City. The Contractor must correct or replace the incorrect, damaged or defective or non-conforming goods within seven business days of the return unless otherwise provided in the Detailed Specifications. The City of Chicago will not be subject to restocking charges.

Failure to correct or replace unacceptable goods, or repeated delivery of unacceptable goods, will be an event of default under this Contract.

16. Manufacturer's Warranty and Product Information

If in performance of the Services, the Contractor provides any goods, the Contractor must have, and must demonstrate upon request, that it has authorization to transfer product warranties to the City of Chicago. The Contractor is required to provide and transfer all documentation issued by the manufacturer for the products to be provided under this Contract. This includes the manufacturer's genuine parts/product information, recall

notices, manuals, licenses, assemblies and/or accessories as supplied by the original equipment manufacturer (O.E.M.).

CSLP Terms for Professional Services With Work

The Contractor must provide the original product warranty and related services for the goods provided under this Contract in accordance with the standard warranty regularly supplied, unless a greater warranty is required in this Section 4.16. The respective manufacturers for luminaires and nodes must warrant the performance and construction of luminaires and nodes and must warrant all parts, components and appurtenances against defects due to design, workmanship or material developing within a period of ten (10) years from the date of Partial Work Order Substantial Completion. The respective manufacturer(s) for access points must warrant the performance and construction of access points and must warrant all parts, components and appurtenances against defects due to design, workmanship or material developing within a period of ten (10) years from the date of acceptance by the City.

With respect to luminaire manufacturer's warranties:

- The inability of a luminaire to be dimmed will constitute a luminaire failure.
- Failure of 10% or more of the LED light sources (packages or arrays/modules) in a luminaire will constitute a luminaire failure.
- The warranty must apply for application on all of the City's existing electrical systems, both grounded and ungrounded.
- During the warranty period the City may, from time to time, test a random sampling of 10-20 luminaires for verification of light output per IES LM-79 and to test dimming functionality for a given luminaire population. The percentage of luminaires not performing as required in the random sampling will be applied to the total population quantity to determine the number of new luminaire replacements that must be delivered to the City by the manufacturer, without expense to the City.

Manufacturer's warranties for luminaires and nodes will take effect for all those luminaires and nodes included in all those atlas pages or four (4) mile segments accepted by the City as of June 30 or December 31 in any given year, at which point the City will grant a certificate of Partial Work Order Substantial Completion with respect to those atlas pages and/or four (4) mile segments.

4.17. Contractor's Warranties

If in performance of the Services, the Contractor provides any goods, the Contractor warrants that the title to the goods to be provided under this Contract is good and its transfer is rightful, and that the goods will be delivered free from any security interest or other encumbrance of which Contractor has not informed the City.

The Contractor expressly warrants that all goods shall be merchantable within the meaning of Article 2-314(2) of the Uniform Commercial Code in effect on the date they are ordered. In addition to all warranties that may be prescribed by law, the goods shall conform to specifications, drawings, and other description and shall be free from defects in materials and workmanship. Contractor also warrants that, except where the goods are produced pursuant to detailed designs furnished by the City, they will be free from defects in design. Such warranties, including warranties prescribed by law, shall run to City, its successors, assigns, customers, and to users of the goods.

Contractor warrants all Work furnished under each Work Order against defect materials and workmanship, improper performance and non-compliance with the Contract for a period of one year after the latest date of approval by the Commissioner of the following:

- (1) Work Order Substantial Completion;
- (2) Completion of all Punch List Work;
- (3) Completion of final inspections; and
- (4) Completion of equipment testing.

This one year period is the "Warranty Period," except as otherwise specifically stated in other parts of the Contract or within such longer periods of time as may be provided by law or by the manufacturer, which periods will then become the Warranty Period as applicable. The warranty is automatic, but if the

CSLP Terms for Professional Services With Work

Commissioner so directs, Contractor must confirm it in writing, including the name of the Work Order as designated in the Contract, signed by an authorized officer of the company. The confirmation must state:

"This document serves as a one year written warranty for the Work performed, and material and equipment installed on the above-referenced Work Order. This warranty incorporates all provisions of the Contract that refer or relate to the warranty. This warranty begins on _____ (date) ."

However, if at any time beyond the one-year Contractor's Warranty period, a latent defect in the work is discovered, the Contractor shall be responsible for re-performance, payment of damages, or such other remedy as deemed appropriate by the City.

If Contractor is a joint venture, the joint venture partners agree to be jointly and severally responsible for Contractor's Warranties to the City.

1. Correction or Re-Performance of Services

If the Contractor has failed to properly perform the Services, upon direction in writing from the Commissioner, Contractor will promptly re-perform or correct all work or Services identified to be defective or as failing to conform to the standards set forth in the Contract Documents, whether observed before or after completion of the Services. The Contractor is responsible for all costs of correcting such defective or nonconforming Services, including costs associated with fixing any damages, re-performing the Services, and any costs required due to Contractor's inadequate performance.

2. Timeliness

The Contractor must provide the Services in the time-frame required in the Detailed Specifications. If Contractor's response and/or completion time for performance of the Services fails to meet this standard, the Commissioner may declare the Contractor in default.

3. Delay

If the City has caused the Contractor be obstructed or delayed in the commencement, prosecution or completion of the Services by any act or delay of the City or by order of the Commissioner, then the time herein fixed for the completion of said Services will be extended for an equivalent period of time.

It is otherwise understood that no extension of time will be granted to the Contractor unless Contractor, immediately upon knowledge of the causes of an unavoidable delay, first notifies the Commissioner in writing, stating the approximate expected duration of delay. Contractor shall not be entitled to an extension of time without such prior notification and request for extension.

The Commissioner will determine the number of days, if any, that the Contractor has been delayed. Such determination when approved and authorized in writing by the Commissioner will be final and binding.

It is further expressly understood and agreed that the Contractor shall not be entitled to any damages or compensation from the City, or be reimbursed for any loss or expense on account of any delay or delays resulting from any of the causes aforesaid.

4.18. Work Performed on City Property

Contractor's personnel will exercise safe and sound business practices with the skill, care, and diligence normally shown by professional technicians employed in the type of Services required under this Contract.

The Contractor will employ only competent and efficient employees, and whenever, in the opinion of the Commissioner, any employee is careless, incompetent, obstructs the progress of the Services, acts contrary to instructions or conducts themselves improperly, the Contractor will, upon the request of the Commissioner, remove the employee from the premises and will not employ such employee again for the Services under this Contract, except with the written consent of the Commissioner.

The Contractor will not permit any person to enter any part of a City facility or property while under the influence of intoxicating liquors or controlled substances. The Contractor will not permit obnoxious behavior, or possession or consumption of alcoholic beverages or drugs anywhere on the site of any Services to be performed under this Contract.

CSLP Terms for Professional Services With Work

The Commissioner has authority to request the Contractor to remove any worker who proves to be incompetent or negligent in his/her duties.

If required by the Detailed Specifications, the Contractor's employees or subcontractors are required to wear suitable uniforms during the time they are on duty on any City property.

The Contractor's employees or subcontractors must wear an identification badge at all times while on duty on any City property.

The Contractor's employees must have proper identification on their person before they will be allowed on any City property.

Smoking is prohibited in all City of Chicago facilities.

The Contractor will require that all employees refrain from disturbing papers on desks, opening desk drawers or cabinets.

While on City premises, the Contractor will not store any equipment, tools or materials without prior written authorization from the Commissioner. The City will not be responsible for or liable to pay the Contractor for any loss of equipment, tools or materials stored in unsecured areas without proper authorization.

4.19. Contractor Practices At Site

1. Cooperation Among Contractors

Contractor must coordinate and tie-in, where appropriate. Contractor's Work with that of other contractors performing work in or adjacent to the project site in an acceptable manner and perform the Work in proper sequence to the work of others. When other contractors cause any damage to the Work that Contractor performed, Contractor must file claims with the other contractors, and not against the City, and Contractor must obtain compensation for damage directly from those other contractors.

2. **Protection of Persons and Property**

(A) Protection of Existing Structures and Property. Contractor must avoid causing damage to trees, plant life, sidewalks, curbs, streets, alleys, pavements, utilities, adjoining property, the work of other contractors and the property of the City and others, and must, at Contractor's own expense, repair any damage that Contractor or any Subcontractor may cause.

Contractor is responsible for loss or damage by fire or theft of equipment, material, or other property of the City, incurred while the equipment, material or other property is located in any field office or on the site of the Work. Further, Contractor must repair or replace any such equipment, material or other property so lost or damaged, to the satisfaction of the Commissioner, at no additional cost to the City.

Contractor must familiarize itself with the requirements of local and state laws applicable to underpinning, shoring and other Work affecting adjoining property and, wherever and whenever required by law, site conditions or standard industry practice, Contractor must shore-up, brace, underpin, secure and protect all foundations and other parts of existing structures adjacent to, adjoining and in the vicinity of the Work site that may be in any way affected by the excavations or other operations connected with the Work to be performed under this Contract.

Contractor is responsible for the giving of all required notices to any adjacent or adjoining property owner or other potentially affected party. The notice must be served in sufficient time so as not to delay the progress of the Work under this Contract.

Contractor must take such precautions as are necessary to insure the safety of private property owners, lessees, and their invitees against injury caused as a result of settlement or displacement of structures. Contractor must immediately proceed with all shoring or other Work necessary to restore the private property owner's property to a safe condition. If Contractor fails to undertake the Work within 24 hours after written notice by the Commissioner, the City may proceed to repair or restore any such structure to a safe condition, and the cost of it will be deducted from any compensation due, or that may become due to Contractor.

CSLP Terms for Professional Services With Work

If, in the prosecution of the Work, it is necessary to excavate or occupy any street, alley, or public grounds of the City, Contractor must erect and maintain such barriers, and, during the night time, such lights as will effectively prevent the happening of any accidents or damage to life, limb, or property in consequence of such excavation or occupation of such street, alley, or public grounds. Contractor is liable for all damage occasioned by Contractor, its agents, employees or Subcontractors of any tier in the excavation or occupation of any street, alley, or public grounds, and Contractor must indemnify the City pursuant to Section 3.1.6., "Indemnity."

Upon each Work Order Final Acceptance, and upon Final Completion and Acceptance of the Work, Contractor must remove all machinery, equipment, materials, false work, rubbish or temporary structures and leave the Work site and the premises of any private property owners in as good condition as they were before commencement of Work.

Materials and equipment necessary for the performance of the Work may only be placed, stored or allowed to occupy any space in public streets or alleys upon the written consent of the Commissioner. It is the City's intent that the operations under this Contract are conducted as far as practicable without interference with the public use of streets and alleys. All materials or equipment used in the performance of the Work must be placed so as not to impede traffic on streets and alleys adjacent to the site of the Work, and to allow free access to all fire hydrants, water valves and manholes that are a part of electric, telephone and telegraph conduit lines, fire alarms and police call boxes in the vicinity.

In removing existing pavements, sidewalks, curbs, gutters, walls, foundations, vaults and other structures, the use of any type of impact device in a manner that might damage buildings or their foundations, or other underground structures and utilities is not permitted.

Contractor must indemnify and hold the City harmless from any damage due to settlement or the loss of lateral support of adjacent or adjoining property and from all loss or expense and all damages for which the City may become liable in consequence of the injury or damage to adjacent and adjoining structures and their premises. Contractor's indemnity obligations will survive the expiration or termination of this Contract and include and apply to any liabilities and duties placed upon the City as owner or occupant of the property on which the improvements provided for in this Contract are to be constructed, by the provisions of an Act entitled "An Act to Prescribe the Duty of an Owner or Occupant of Lands Upon Which Excavations are Made in Reference to the Furnishing of Lateral and Subjacent Support to Adjoining Lands and Structures Thereon." See of 765 ILCS 140/0.01 et seq.

(B) Existing and Proposed Utilities. The Contract may show existing utilities lying within the limits of the Work, such as sewers, manholes, catch basins, gas lines, water lines, telephone and electrical duct lines, CTA facilities, and similar structures. The City does not guarantee the completeness or accuracy of the information regarding utilities, whether public or privately owned. Contractor must make its own

investigation to determine the existence, nature and location of all utilities at the Work site. Contractor must verify the exact location of all utilities that may interfere with performance of the Work and must report to the Commissioner any differences from the locations shown on the Contract.

Contractor must so arrange and conduct its Work that utilities may be removed, relocated or supported during excavation and maintained in service until the Work is completed. In addition, Contractor must arrange and conduct its Work that utilities may be replaced, rearranged or relocated before backfill being placed. Contractor must cooperate with the owners of those utilities in the performance of the Work.

Where existing utilities are abandoned and it is necessary to remove them due to the performance of the Work, Contractor must remove them at no additional cost to the City, and they will become Contractor's property.

CSLP Terms for Professional Services With Work

It is Contractor's responsibility to protect those existing utilities that are to remain in operation during and after completion of the Work, and any new utilities installed by others during the performance of the Work. Contractor will be held fully responsible for any damage resulting from Contractor's performance of the Work, and will be required to repair, replace or reconstruct any utilities damaged, at Contractor's own expense, to the satisfaction of the Commissioner. The protection of the utilities as specified in this Contract must be at no additional cost to the City.

(C) Utilities Outside the Limits of the Work. Contractor must protect and maintain City-owned water lines, sewers, connections and appurtenances and all City-owned electrical conduits, cables, vaults and appurtenances that are located entirely outside the limits of the Work in a satisfactory manner until the completion of the Work. Whenever in the performance of the Work it is necessary, because of the nature of the Work or because of Contractor's method of performing the Work, to support, remove, replace, relocate, rearrange, adjust or repair such City-owned structures located entirely outside of the excavations, Contractor must notify the appropriate City department to perform the Work, and must cooperate with the department in preserving service. Contractor must reimburse the appropriate City department for the cost of performing the Work at no additional cost to the City under the terms of this Contract.

(D) Utility Relocation and Continuance of Service Plan. If applicable, Contractor must prepare a Utility Relocation and Continuance of Service Plan, identifying procedures, locations, time frames and affected agencies and private owners. The Plan must be submitted to the Commissioner for review within 14 days after the Notice to Proceed for each applicable Work Order Release.

(E) Cooperation with Utilities. Contractor must cooperate with all utility companies involved in connection with the removal, temporary relocation, reconstruction, or abandonment by these agencies of all services or facilities owned or operated by them within the limits of the Work.

(F) Work Performed by Others. The Work must be performed with a minimum of interference to street traffic in the area. Contractor must coordinate its Work with that of other City contractors, with contractors employed by adjacent property owners, and with contractors employed by any other party or parties for work on utilities to insure the best progress of the Work as a whole.

(G) Preservation and Protection of City Standard Bench Monuments and Survey Controls. Contractor is responsible for the preservation and protection of all City Standard Bench Monuments, in accordance with the provisions of § 10-4-220 of the Municipal Code and Article 105.09 of the Standard Specifications, and as directed by the Commissioner. Any survey control point that Contractor disturbs or removes must be replaced or reestablished to the satisfaction of the Commissioner, at no additional cost to the City. **DAMAGE TO ANY OF THE CITY STANDARD BENCH MONUMENTS WILL RESULT IN CONTRACTOR BEING PROSECUTED TO THE FULL MEASURE OF THE LAW.** The Department of General Services will pursue the matter of compensation for damages incurred by the City resulting from Contractor's actions or Contractor's failure to act during the execution of Work on this project.

(H) Protection of Streets and Traffic. Contractor must provide all necessary barricades, signs, flags, lights and reflectors. Contractor must assure that vehicular and pedestrian traffic on all streets, including adjacent streets, bridges, overpass structures and ramps is maintained during the performance of the Work in accordance with the requirements of the Contract.

(I) Temporary Restoration of Trench Cuts. Failure to maintain the temporary restoration of trench cuts, which causes the surrounding work area to be in an impassable and/or hazardous condition thereby creating undue inconvenience and danger to area residents is an event of default under this Contract.

(J) Temporary Barriers, Signs, Lights and Flaggers. Contractor must furnish, relocate and remove portable barricades and lights, collision protection, temporary signs (including traffic and project signs) and supports as directed by the Commissioner; and furnishing all

necessary flaggers and other

CSLP Terms for Professional Services With Work

protection necessary for the maintenance of traffic flow in a safe and orderly fashion, as required by Article 107.14 of the IDOT Standard Specifications, except as otherwise specified in the Contract.

Contractor must maintain, repair or replace all damaged or destroyed appurtenances referenced in the immediately preceding paragraph throughout the life of the Contract. Maintenance includes cleaning of the barricades and traffic signs by means of clean water. Flaggers must be provided whenever circumstances warrant.

The barricades must be erected, moved, repaired and repainted as required. Upon the completion of the Work, all barricades remain Contractor's property and must be promptly removed from the Work site.

Historical and Scientific Specimens. Contractor must preserve and deliver to the Commissioner any specimens of historical or scientific value encountered in the Work, as directed by the Commissioner.

3. Protection of Streets, Alleys and Public Grounds

When excavating or occupying any street, alley or public grounds of the City, Contractor must erect and maintain temporary barriers and, during the night time, lights that will effectively prevent accidents or damage to life, limb or property in consequence of the excavation or occupation of the street, alley or public grounds. Contractor is liable for all damages as a result of the excavation or occupation of any street, alley or public grounds, or by the carelessness of Contractor, its subcontractors, agents, employees or workers and must indemnify and hold harmless the City against all judgments rendered against it by reason thereof.

4. Protection of Existing Trees in the Right of Way

(A) In accordance with the provisions of Chapter 10-32 of the Municipal Code Contractor must protect all trees and shrubs at the construction site from damage. Contractor must restore all damaged parkways to their original condition and repair or remove and replace any trees and shrubs damaged as a result of construction activity (as determined by the Department of Streets and Sanitation, Bureau of Forestry) at Contractor's expense. If any trees or shrubs damaged by construction activity must be removed and replaced, and trees or shrubs of comparable size, type, and value are unavailable or the time for planting is unsuitable, the City will charge Contractor their appraised value determined as provided under § 10-32-200 of the Municipal Code, which amount the City will deduct from amounts due Contractor, or, if no amounts are due, then Contractor must promptly pay the City the amounts determined. Any tree greater than 4" D.B.H. that is permanently damaged due to the construction project and not originally marked for removal must be replaced with a new tree as identified by the Bureau of Forestry and must have a minimum of 4" caliper B&B. Any damaged tree smaller than 4" caliper measured 6" above the ground must be replaced in kind, inch for inch.

(B) Contractor must install a protection barrier or temporary fence of at least 1.2m (4 feet) in height around each tree to be protected and preserved. The tree protection must be installed before the actual construction starts and maintained for the duration of the project.

Within this protection zone, Contractor must prevent construction materials from being stored, equipment from being operated and temporary storage buildings or work trailers from being placed.

The protection barrier must be constructed of orange snow fencing securely fastened to fence posts spaced a maximum of 1.5 m (5 feet) on center. Posts are 1.8m (6 feet) in length with 61 cm (2 feet) set into the ground and 1.2m (4 feet) extending above ground. The fencing must be attached to the post with a minimum of four nylon locking ties evenly spaced at each post.

Dimensions of the protection barrier are as follows:

CSLP Terms for Professional Services With Work

Dry rjndvJ r-rcfwwiii S.-rvk:--. iV;;;j-

Trees located in Tree Pits: Where trees are located within Tree Pits, the temporary fencing should be installed at a minimum distance of the inside dimension of the Tree Pit opening with one stake at each corner of the opening.

Trees located in Parkways or Boulevards:

Small Trees (<9" D.B.H.): Minimum 1.5m (5 feet) from face of tree along the parkway length. In the dimension bordered by the public

sidewalk or curb, the temporary fencing must be the width of the grass parkway with a maximum offset of 30cm (1 foot) from back of curb or edge of sidewalk. In no case must the closure be less than 61cm (2 feet) from the centerline of the tree.

(Example: 6" Tree in a 6' parkway as measured from back of curb to sidewalk. The dimension of the protection fencing would be 1.2m x 3m (4' x 10') with tree in the center). Note: Larger grass parkways (>12') may allow for a ten foot by ten foot (10' x 10'). Thus, the dimension bordered by the sidewalk or curb would not affect fencing distance.

Medium (10"to 15" D.B.H.): Minimum often (10) feet from face of tree along the parkway length. In the dimension bordered by the public sidewalk or curb, the fencing must be the width of the grass parkway with a maximum offset of one foot from back of curb or edge of sidewalk. In no case must the closure be less than two feet from the centerline of the tree.

Large (>15" D.B.H.): Minimum of 15 feet from face of tree along the parkway length. In the dimension bordered by the public sidewalk or curb, the fencing must be the width of the grass parkway with a maximum offset of one foot from back of curb or edge of sidewalk. In no case must the closure be less than two feet from the centerline of the tree.

4.19.5. Care of Existing Structures and Property

(A) Property Access Maintenance Plan. Contractor must prepare a Property Access Maintenance Plan consistent with the requirements of the Contract. The plan must be submitted to the Commissioner for review within 14 days after award of the Contract. Contractor must comply with all applicable Federal, State, and local requirements. Contractor must also comply with the following requirements:

- (1) Maintain vehicle and pedestrian access to properties;
- (2) Maintain pedestrian access on both sides of all streets;
- (3) Provide access walkways to all buildings and businesses;
- (4) Sidewalks must remain open to the maximum extent possible;
- (5) Provide temporary relocation of access, where required;
- (6) Provide advisory and temporary signs for pedestrian and vehicle access changes and reroutings; and
- (7) Coordinate delivery locations and timing.

(B) Before doing any Work adjacent to or on the site of any buildings or other structures adjoining or in the line of the Work to be performed under the Contract, Contractor must supply written notice of it to the owner or owners that the Work is to be done, and must cooperate with the owner(s) in the maintaining, removing, relocating, rearranging or adjusting wherever necessary, of all basements of buildings, subsidewalk vaults, tunnels, conduits, wires, poles, pipes, gas mains, cables, steam and street railway tracks and equipment, or other appliances and structures located in any portion of the streets, public areas, highways and easements to be occupied or used during the prosecution of the Work.

(C) Wherever in the performance of the Work it is necessary to remove, reconstruct, relocate, rearrange, adjust or repair City-owned sewers, catch basins, manholes, inlets, sewers connections and appurtenances by reason of the fact that the structures and appurtenances pass through or are

(B)

CSLP Terms for Professional Services With Work

located within the limits of the Work as shown on the plans, or ordered by the Commissioner Contractor must perform the Work necessary to remove, reconstruct, relocate, rearrange, adjust or repair those structures and appurtenances, unless otherwise noted on the plans.

- (1) The Commissioner will, at his sole discretion, direct Contractor to modify its method of Work to interfere as little as possible with the normal conduct of business in or around the portions of the buildings or structures in use.
- (2) The building or structures may be in full time use and operation and will continue in normal use during performance of the Work. Building facilities, including heating, ventilation, and air conditioning, lighting and plumbing, will not be interrupted in the occupied areas, except as required for making connections to power sources as specified below.
- (3) Contractor will serve written notification to the Commissioner requesting any anticipated interruption in facilities at least two weeks before disruption of services. Contractor must provide any temporary facilities deemed necessary by the Commissioner due to a disruption of services. The Commissioner, in his sole discretion, will determine the procedures, times of day and dates Contractor may accomplish the Work and may reject or modify Contractor's request.
- (4) Storage of all material and/or equipment must be in areas approved by the Commissioner, in a manner to minimize interference with the normal conduct of business in or around the occupied portions of the building and vehicular areas.

(D) Contractor must not perform Work on City-owned water mains, connections and appurtenances or on any City-owned electrical conduits, cables, vaults and appurtenances unless the City has abandoned the structure and the Commissioner has authorized the Work or the Work is included in the Contract. But, Contractor must adjust City-owned water manholes and electric manholes that are shown as "to be adjusted" on the plans.

(1) Contractor must protect and maintain in a manner satisfactory to the Commissioner, protect and maintain all City-owned water mains, connections and appurtenances and all City-owned electrical conduits, cables, vaults and appurtenances that are located entirely outside of the neat lines of the excavation as shown on the plans or as ordered by the Commissioner, until the completion of the Work under the Contract. Whenever in the performance of the Work under the Contract it becomes necessary because of the nature of the Work required by the Contract or because of Contractor's method of performing the Work, to support, remove, replace, relocate, rearrange, adjust or repair those City-owned structures located entirely outside of the excavations, Contractor must notify the appropriate City Department to perform the Work, and must cooperate with the Department in preserving service in or through them. Contractor must reimburse the appropriate City Department for the cost of performing the Work, and the cost must be included in the various Contract prices.

(2) Without cost to Contractor the City will support, protect and maintain all City-owned water mains, connections and appurtenances and all City-owned electrical conduits, cables, vaults and appurtenances, any part of which is located inside of the neat lines of the excavations as shown on the plans or ordered by the Commissioner, or it will remove, replace, relocate, rearrange, adjust, or repair them, both inside and outside of the excavations. Contractor, however, must adjust those City-owned water manholes and electric manholes that are shown as "to be adjusted" on the plans. Whenever in the performance of the Work under the Contract it becomes necessary to support, protect, maintain, remove, replace, relocate, rearrange, adjust or repair such City-owned structures any part of which is located inside of the excavations, Contractor must notify the appropriate City department to perform the Work and must cooperate with the department in preserving service in or through them.

(3) With the exception of the City-owned water mains, connections and appurtenances and the City-owned electric conduits, cables, vaults and appurtenances described above, and

(1)

CSLP Terms for Professional Services With Work

with the exception of City-owned structures that are to be removed or otherwise Worked upon as part of the requirements of the Contract, Contractor must support, protect, maintain or relocate and rebuild all poles, trees, shrubbery, fences, sewers, pipes, conduits, cables, wires, manholes, tunnels, buildings, subways and other City-owned structures that pass through and are located within the excavations or that are adjacent to the Work to be constructed under the Contract during the construction and until the completion of the Work under the Contract.

(E) Contractor must notify and cooperate with the owners thereof in maintaining, removing, relocating, rearranging, or adjusting wherever necessary, all basements of buildings, subsidewalk vaults, tunnels, conduits, wires, poles, pipes, gas mains, cables, steam and street railway tracks and equipment or other appliances or structures located in any portion of the streets, public areas, highways and easements that are to be occupied or used during the construction of the Work specified under the Contract.

(1) Wherever in the performance of the Work specified under the Contract it becomes necessary to remove, replace, rearrange, adjust or repair City-owned sewers, catch basins, manholes, inlets, sewer connections and appurtenances by reason of the fact that the structures and appurtenances pass through or are located within the limits of the excavations as shown on the plans or ordered by the Commissioner, Contractor must perform the Work necessary to remove, replace, relocate, rearrange, adjust or repair the structures and appurtenances. The cost of performing the Work must be included in the Contract price.

(2) Wherever in the performance of the work specified under the Contract it becomes necessary to support and maintain City-owned sewers, catch basins, manholes, inlets, sewer connections and appurtenances or wherever it becomes necessary as a result of Contractor's methods of construction during the Work under the Contract, to remove, replace, relocate, rearrange, adjust, or repair City-owned sewers, catch basins, manholes, inlets, sewer connections and appurtenances (other than those specified in the last preceding paragraph) Contractor must perform the Work necessary to support, maintain, remove, replace, relocate, rearrange, adjust or repair the structures and appurtenances, and Contractor must bear the cost of the Work without any additional compensation for it.

(3) It is the intention of the specifications that Contractor includes in the appropriate Contract Price or prices, all necessary cost and expense of supporting, maintaining, removing, replacing, relocating, rearranging, adjusting or repairing all City-owned appliances and structures (other than City-owned water mains, connection and appurtenances and City-owned electrical conduits, cables, vaults and appurtenances), encountered in or affected by the Work, and that Contractor must also include in the price or prices all necessary cost and expense of removing structures that have been or will be abandoned by their owners and that are necessary to be removed in order to construct work under the Contract, but Contractor must not include in the price or prices the cost or expense of supporting, maintaining, moving, replacing, relocating, rearranging, adjusting or repairing those appliances or

structures that are not owned by the City and are not abandoned by their owners, except as may be otherwise specified below in this Section.

(F) Contractor must take all reasonable precautions for the protection of buildings, railroad tracks, street railway tracks and appurtenances, and other appliances and structures not owned by the City.

(G) Contractor must determine the methods to be employed, the procedure to be followed, the equipment, plant, falsework, shoring, bracing and other temporary structures and equipment to be used on the Work, subject to the requirements of the Contract and the approval of the Commissioner. Only adequate and safe procedures, methods, structures and equipment must be used.

(F)

CSLP Terms for Professional Services With Work

(H) Contractor must provide drawings and calculations for all equipment, falsework, shoring, bracing and other temporary structures required for the Work, designed, signed and sealed by an Illinois licensed structural engineer. Contractor must submit copies of all such drawings and calculations to the Commissioner for information only.

(I) Field Check of Dimensions, Cutting and Patching. Where the Work connects to existing structures or appurtenances, Contractor must take complete field measurements affecting all Work under this Contract and are solely responsible for the proper fit between the Work and existing structures or appurtenances. Contractor must perform all cutting, patching, or fitting of Work that may be required to properly fit together the several parts of the Work and the existing structures or appurtenances.

(J) Contractor's Layout of the Work. Contractor is responsible for the correct lay-out and accurate fitting of all parts of the Work. Contractor must furnish at its own expense all labor, materials and other expenses necessary for, or incidental to, the setting and maintaining of lines and grades (exclusive of the Work of establishing the original reference base line and bench marks that will be performed by the City). No separate payment to Contractor for the cost of any of the Work specified in this Contract. The cost is included in the Contract unit or lump sum prices.

(K) Salvage of Materials. If and whenever City- owned property such as valves, cast iron manholes, catch basin frames and covers, inlet boxes and grates, or any other appurtenance are to be removed and are not to be reused in the Work, Contractor must securely store them at a suitable place on the job Site for possible use by the City (unless otherwise stipulated). Contractor must take care to prevent damage in its handling of these appurtenances. Contractor must deliver all items identified by the City for reuse to a location designated by the Commissioner and must legally dispose of the remaining items.

(L) Wherever basements of buildings, subsidewalk vaults, tunnels, sewers, water, gas, telephone, telegraph, electric or other pipes, conduits, cables, wires, manholes, vaults, steam and street railway tracks or other similar structures and appliances not owned by the City are in or cross the excavations for structures to be built under this Contract, Contractor must notify the owners of the structures and appliances to support, move, rearrange or abandon them, and cooperate with the owners of the structures and appliances in preserving the service or services provided by the structures and appliances, except as may be otherwise specified or provided in the Contract. If Contractor has complied with the above requirements and has been notified by the owners of the structures and appliances that any of them have been abandoned, or lacking such notice, if Contractor has made all investigations and has found that any of the above structures or appliances have been abandoned by their owners and if the removal of any such abandoned structure or appliance is necessary in order to construct the Work, Contractor must remove them at no additional cost to the City.

(M) Wherever basements of buildings, subsidewalk vaults, tunnels, sewers, water, gas, telephone, telegraph, electric or other pipes, conduits, cables, wires, manholes, vaults, steam and street railway tracks or other similar structures and appliances are adjacent to, but do not cut through or cross the excavations for structures to be built under the Contract, Contractor must perform the Work in such a manner as to not cause damage to the structures and appliances and not interrupt their use during the progress of the Work.

(N) Contractor must arrange to notify the owners of structures and appliances that are to be supported, maintained, removed, reconstructed, relocated, rearranged, adjusted or repaired by reason of the Work in ample time to permit them to do their work. The Commissioner may direct Contractor to suspend its operations on that part of the Work that affects the structures and appliances until their owners have had time to perform the work.

(O) Contractor must conduct the Work so that no equipment, material or debris is placed upon private property unless Contractor has first

obtained the owner's written consent thereto and

CSLP Terms for Professional Services With Work

provided this written consent to the Commissioner. Contractor must take such means as may be required to prevent the creation of a public nuisance on any part of the Work site or adjacent streets or property.

(P) Contractor must thoroughly clean all streets, pavements, sidewalks and parkways and all private property of all surface materials, earth and rubbish and restore them to as good condition as before the commencement of the Work. Where Contractor has removed or killed sod, Contractor must provide new live sod. Where the areas have been seeded. Contractor must replace top soil equivalent to that removed, fertilize it, seed and roll it to the satisfaction of the owner of the land. Contractor must replace all trees, shrubs and plants damaged in the proper season of the year with live, growing stock of the same kind and variety and of the size ordinarily used for planting purposes.

4.19.6. Precautions and Safety

(A) Contractor must take any precautions that may be necessary to render all portions of the Work secure in every respect, to decrease the liability of accidents from any cause and to avoid contingencies that are liable to delay the completion of the Work. Contractor must furnish and install, subject to the approval of the Commissioner, all necessary facilities to provide safe means of access to all points where Work is being performed and make all necessary provisions to insure the safety of workers and of engineers and inspectors during the performance of the Work. Contractor is required to conduct its Work so as not to unnecessarily obstruct the activities of other contractors who also may be engaged in work on this or any other project.

(B) Although the Commissioner may observe the performance of the Work and reserves the right to give Contractor opinions and suggestions about safety defects and deficiencies, the City is not responsible for any unsafe working conditions. The Commissioner's suggestions on safety, or lack of it, will in no way relieve Contractor of its responsibility for safety on the Work site. Contractor has sole responsibility for safety and the obligation to immediately notify the Commissioner of all accidents.

(C) Precautions must be exercised at all times for protection of persons (including employees) and property. The safety provisions of applicable laws and building and construction codes must be observed.

(D) Contractor must provide completely equipped first aid kits readily accessible at all times on the Work site. Contractor must designate an appropriately trained individual on each shift to be in charge of first aid.

(E) Contractor must provide at appropriate locations fire extinguishers or other fire protection equipment that comply in all respects with the Municipal Code and NFPA standards. Contractor must maintain this equipment in proper operating condition at all times and must cause the equipment to be inspected by all appropriate agencies as required by law, but in no event less than monthly. Contractor must comply with the Municipal Code requirements on the use of standpipes, hoses and other fire protection equipment.

(F) Only such materials and equipment as are necessary for the construction of the Work under this Contract must be placed, stored or allowed to occupy any such space at the site of the Work. Not more than one day's supply of flammable liquids, including oil, gasoline, paint, or solvent is permitted to be kept on hand at any one time. If gasoline, flammable oils, other highly combustible materials or compressed gas cylinders are to be stored at the site, they must be stored in a secure manner, in compliance with all applicable laws, ordinances and regulations, and all storage places must be clearly marked. The written consent of the Commissioner is required for such storage. That consent in no way limits Contractor's liability for the materials.

(G) Contractor must prohibit all lighting of fires about the premises and all smoking in restricted areas where posted with "NO SMOKING" signs, and Contractor must diligently enforce this prohibition. Contractor must furnish and post "NO SMOKING" signs. Contractor must not permit any debris or waste materials to be burned at the Work site.

(A)

CSLP Terms for Professional Services With Work

4.19.7. Health, Safety and Sanitation

(A) Clean-Up. During construction, Contractor must keep the Work site and adjacent premises as free from material, debris and rubbish as practicable. Haul roads, streets and public areas must be swept daily. Before Final Completion and Acceptance of the Work, Contractor must remove from the Work site and adjacent premises all machinery, equipment, surplus materials, falsework, excavated and useless materials, rubbish, temporary buildings, barricades and signs and must restore the site to the same general conditions that existed before the commencement of the Work. The cost of final clean-up is included in the unit prices for the various items, or included in the Contract lump sum price, as the case may be. Contractor must clean off all cement streaks or drippings, paint smears or drippings, rust stains, oil, grease, dirt and any other foreign materials deposited or accumulated on any portion of Contractor's Work, or existing facilities and structures, due to Contractor's performance of the Work.

(B) Snow and Ice Removal. Contractor must remove snow and ice that may impair progress of Work, be detrimental to workers, or impair trucking to and from points of delivery at the Work site.

(C) Glass Breakage. Contractor must replace all glass broken or damaged during construction at no additional cost to the City. Contractor must promptly remove all broken glass from the Work site.

(D) Noise and Vibration Control. All equipment, vehicles, and Work under this Contract must be conducted in accordance with the City Building Code, Chapter 11-4 of the Municipal Code, "Environmental Protection and Control," Article VII - Noise and Vibration Control, so as to cause a minimum of noise, vibration and inconvenience to the activities of the occupants of property and buildings in the vicinity of the Work. When the Commissioner, in his sole discretion, determines that Contractor's operations constitute a nuisance, Contractor must immediately proceed to conduct its operations in a manner that abates the nuisance. Contractor must provide all measures, including engine and exhaust mufflers, acoustic casing enclosures, maintaining equipment, or physical barriers along the edges of the construction zone, required to minimize noise and vibration. Noise and vibration levels may be monitored by the Commissioner.

(E) Health and Safety. Contractor must comply with the requirements of 29 C.F.R. part 1926 -Safety and Health Regulations for Construction, promulgated under the U.S. Occupational Safety and Health Act of 1970, as amended, 29 U.S.C. 651 et seq. (OSHA). Copies may be obtained from the Regional Administrator of the U.S. Department of Labor, Federal Office Building, 230 S. Dearborn, Chicago, Illinois.

Contractor must comply with the requirements of the Illinois Health and Safety Act, 820 ILCS 225/01 et seq., and the rules and regulations promulgated under it by the Director of Labor for the State of Illinois, which are on file with the Illinois Secretary of State.

Whenever a Federal OSHA Compliance Officer arrives at the work site, Contractor must notify the Commissioner immediately. At the conclusion of the inspection, Contractor must report any findings to the Commissioner. Copies of any citations issued and related documents must be submitted to the Commissioner.

Contractor must maintain the following records and make available to the Commissioner for review: (i) all records required by OSHA, including the accident log, Fed/OSHA #200, and posting of the prescribed OSHA poster; (ii) log of safety activities, accident investigation, employee instruction, training, tool-box meetings, and any other pertinent information; and (iii) Material Safety Data Sheets (MSDS) as required for each material Contractor has used at the Work site.

(F) Contractor must enforce among its employees such regulations in regard to cleanliness and the disposal of garbage and wastes that are necessary for their health and tend to prevent the inception and spread of contagious and infectious disease among them. Contractor must provide an ample supply of suitable, pure drinking water, and must take such means as the Commissioner may direct to effectively prevent the creation of a nuisance on any part of the Work site or adjacent streets or property. Contractor must construct and maintain necessary sanitary conveniences for the use of the laborers on the Work, properly secluded from public observation, in such manner and at such points as be

(F)

CSLP Terms for Professional Services With Work

approved, and their use must be strictly enforced. Whenever manholes have been used for sanitary proposes, they must be thoroughly flushed and cleaned when no longer needed.

The manner of disposing of waste must be such that all waste is disposed of without creating a public nuisance or health hazard and in accordance with Illinois Department of Public Health Circular No. 815, Educational Health Circular No. 4.001, and all Illinois Environmental Protection Agency rules and regulations.

Contractor must also comply with all rules and regulations of the Federal and State governments and the City Department of Public Health.

4.19.8. Hazardous Operations and Security

(A) During construction, all cutting or welding operations must be carried out with all precautions taken to prevent fires resulting from sparks or hot slag. Extreme care must be exercised to determine that sparks or embers do not fall into any combustible materials, even if such material is stored on lower floors. Sheet metal wind screens must be provided around the lead-melting furnaces whether the Work site is enclosed or not. Portable fire extinguishers must be provided at and below all locations where cutting or welding or melting operations are being performed or, if those operations are extensive, a hose from the stand pipe system or fire hydrant must be placed nearby. Contractor must obtain special permission from the Commissioner of Water and pay all associated connection fees.

(B) No welding, flame cutting, or other operations involving use of flame, arcs, or sparking devices, will be allowed without adequate protection. All combustible or flammable material must be removed from the immediate working area. If removal is impossible, flammable or combustible materials must be protected with fire blankets or suitable non-combustible shields to prevent sparks, flames or hot metal from reaching flammable or combustible materials. Contractor must provide necessary personnel and equipment to control incipient fires resulting from welding, flame cutting, or other sources involving use of flame, arcs, or sparking devices.

(C) Contractor must immediately report any concentration of gas fumes, and Contractor is responsible for clearing the area and notifying

the Commissioner and the appropriate utility company. All operations in the area must be suspended until the source of the fumes has been located and corrected.

(D) Contractor must arrange for the installation of necessary fire protection lines and equipment as required by the Chicago Fire Department and as necessary to properly protect the Work site. Permanent fire protection facilities may be used for this purpose as soon as they are installed, tested and approved by the Commissioner for temporary use.

(E) Salamander heaters or similar forms of uncontrolled heaters must not be used except with the special written permission of the Commissioner and City fire marshal and then only when each salamander is maintained under constant supervision.

(F) Gasoline must be kept in and handled from approved safety cans.

(G) All tarpaulins used for any purpose must be made of fire, water and weather-resistant materials.

(H) Contractor must furnish such watchmen as may be necessary to protect the public and those who are at or in the vicinity of the Work under this Contract, and to protect all materials, tools, machinery and equipment and all Work Contractor has performed.

(I) Contractor must comply with all Federal and State and local occupational health and safety statutes, and any occupational health and safety standards promulgated thereunder; provide reasonable protection to the lives, health and safety of all persons employed under this Contract; furnish to all such persons a place of employment that is free from recognized hazards that are causing or are likely to cause death or serious physical harm; keep all persons employed under this Contract informed of Contractor's protections and obligations under the statutes; and provide all persons employed under

CSLP Terms for Professional Services With Work

this Contract with information regarding hazards in the workplace, including information about suitable precautions, relevant symptoms and emergency treatment. The Federal and State occupational health and safety statutes, and the rules and regulations promulgated thereunder, are considered part of this Contract as though fully set forth in this Contract.

(J) Contractor must provide safety instructions and training for all workers. Contractor must conduct weekly craft safety meetings (tool-box type) of reasonable length as an effective means of communicating safety issues to workers. Reports containing tool box discussion topics must be signed-off by all attendees and must be submitted to the Commissioner.

20. Work In Progress

Any Services in progress at the termination date of the Contract will be completed by the Contractor in the most expedient method available. In no event will the Contractor be relieved of its obligations under this Contract until all Services requested prior to the expiration of the Contract has been completed and accepted by the Commissioner.

21. Final Completion and Acceptance of the Work

When Contractor deems the Work to be complete, Contractor must notify the Commissioner, in writing, that the Work will be ready for an inspection and/or test on a date Contractor specifies. The notice must be given at least 15 calendar days in advance of the date. If the Commissioner concurs that the Work will be ready for inspection or testing on the date given, the Commissioner will make the inspection within a reasonable period of time. The scheduling of the inspection to determine whether the Work is complete does not relieve Contractor of its responsibilities under the Contract. Contractor must cooperate in all respects in the scheduling and performance of the inspection.

Payment of Remaining Retainage at Final Completion and Acceptance of the Work. Unless expressly stated otherwise in the Contract Documents, the remaining Retainage will be paid when all Work, including Punch List Work, is complete and Contractor submits to the Commissioner, within 180 calendar days or sooner from the Substantial Completion Date, a sworn affidavit stating the following:

1. All payrolls, invoices for materials and equipment and all other indebtedness connected with the Work for which the City might in any way be responsible have been paid or otherwise satisfied;
2. All waivers of lien required by the Contract have been provided to the Commissioner;
3. As of the date the affidavit is signed, all known claims made by Subcontractors of any tier and others against Contractor, the City, any agents or representatives of the City pertaining to the Work required under this Contract were provided in writing to the Commissioner and have been resolved;
4. The warranties and guarantees required by the Contract have been provided to the Commissioner;
5. All warranties and guarantees are in full force and effect;

6. The surety's written consent, signed by its authorized representative, to final payment being made directly to Contractor is attached to the affidavit;
7. Acceptance of final payment will constitute a general release to the City, its agents, representatives, officials and employees of all other claims of liability for anything done or furnished or relating to the Work or for any act or neglect of the City or its agents, representatives, officials and employees relating to or connected with this Contract;
8. All documents requested by the Commissioner have been provided; and
9. Wages paid and classifications for laborers and mechanics, including apprentices and trainees employed on the Project, in the following form:

1.

CSiP Terms for Professional Services With Work

FINAL CERTIFICATE

The undersigned, Contractor on (Specification No:

/Contract No.) certifies that all laborers, mechanics, apprentices and trainees employed by it or by a Subcontractor performing Work under the Contract have been paid wages at rates not less than those required by the Contract provisions, and that the Work performed by each such laborer, mechanic, apprentice or trainee conformed to the classifications set forth in the Contract or training program provisions applicable to the wage rate paid.

Signature and Title

Name Title Authorized Officer

Contractor: Project:

The payment of the remaining retainage to Contractor signifies the City's Final Completion and Acceptance of the Work.

4.22. Representations and Covenants

- A. Contractor represents to the City that:
 - i. It has the requisite corporate power and authority to execute, deliver and perform its obligations under this Contract and it is financially solvent;
 - ii. The execution, delivery and performance of this Contract have been duly authorized by the Contractor;
 - iii. No approval, authorization, or consent of any governmental or regulatory authority is required to be obtained or made by Contractor in order for it to enter into and perform its obligations under this Contract;
 - iv. It has obtained all applicable permits, rights, and licenses required in connection with Contractor performing its obligations hereunder;
 - v. It and each of its employees, agents. Subcontractors of any tier are skilled and experienced in the activity to be performed by such person and competent to perform the Services required under this Contract;
 - vi. Any certification, affidavit or acknowledgment made under oath in connection with this Contract is made under penalty of perjury and, if false, is also cause for termination of this Contract for default.
- B. Contractor covenants to the City that:
 - i. It will comply with all applicable federal, state, and local laws and regulations;

CSLP Terms for Professional Services With Work

- ii. It will obtain all applicable permits, rights and licenses required in connection with the Contractor performing its obligations hereunder;
 - iii. The Services and any software used by the Contractor in providing the Services and the Deliverables will not infringe upon the trademark, copyright, trade secrets or other proprietary rights of any third party; and
 - iv. It will not, directly or through a third party, remove, alter, change or interface with the Deliverables for any purpose of preventing the City from utilizing the Deliverables.
- ii.

ARTICLE 5. SCOPE OF WORK AND DETAILED SPECIFICATIONS

1. Scope of Services

This Contract is for the Chicago Smart Lighting Project ("Project"), which is a city-wide lighting modernization initiative intended to: (1) improve the quality and reliability of Chicago's outdoor lighting, thereby enhancing public safety and quality of life for Chicago's residents and visitors; and (2) leverage the light grid as a platform for connected technologies that will improve safety, service delivery, communications, and responsiveness. The Scope of Services includes: (1) LED fixture procurement and installation; (2) targeted stabilization repairs of existing lighting infrastructure; and (3) design and implementation of the Citywide Lighting Management System.

More specifically, the Services that Contractor must provide are described in Exhibit 1, "Scope of Work." The Lighting Management System solution provided under this Contract must comply with the Technical Specifications in Exhibit 1B of this Contract, "Lighting Management System Solution Technical, Functional and Service Requirements." The Lighting Management System solution must also comply with the requirements in Exhibit 7 and Exhibit 8 of this Contract, "Data Protection Requirements for Contractors, Vendors and Third-Parties" and "New Information Security Policies," respectively.

The LED conversion and stabilization repair Services will be determined on an as-needed basis and as described on a Work Order Release ("WOR") (which process is described in Section 5.7 below). WORs will indicate the specification number, purchase order number, project description, milestones, deadlines, funding, and other such pertinent information. The Lighting Management System technology Services are set forth in Exhibit 1 and Exhibit 1B; Contractor will receive a Purchase Order for these Services. The City reserves the right to issue additional technology scopes of work in the form of a Task Order Request (which process is described in Section 5.8 below).

This description of Services is intended to be general in nature and is neither a complete description of Contractor's Services nor a limitation on the Services that Contractor is to provide under this Contract.

2. Authorized Dealer

The Contractor must be the manufacturer of, or an authorized dealer or distributor of the manufacturer of, the luminaires and nodes supplied under this Contract. The Contractor must be able to provide genuine parts, assemblies and/or accessories as supplied by the original equipment manufacturer (OEM). Further, the Contractor must be able to provide original product warranty and manufacturer's related services such as product information, product recall notices, etc.

Documentation which validates the Contractor's current status of authorized dealer or distributor must be submitted with the bid. Contractor must also demonstrate that it has authorization to transfer product warranties to the City of Chicago.

3. List of Key Personnel

Key Personnel are:

Steve Taggart, Regional Director, Ameresco

Gil Bucio, Director of Development Engineering, Ameresco

Fernando Orihuela, Director of Construction, Ameresco

Luis Beita, Sr. Project Manager, Ameresco

Louis P. Maltezos, Executive Vice President, Ameresco

Andrew Carnegie, Vice President, John Burns Construction Company

Eric Probst, Program Manager, John Burns Construction Company

Scott Blackburn, Vice President, Client Delivery, Silver Spring Networks

Mary Jo Pennino, Project Engagement Manager, Silver Spring Networks

CSLP Scope of Work and Detailed Specifications

Ari Isaak, Founder and CEO, Evari GIS Consulting

Anthony J. Algmin, Chief Data Officer, Uturn Data Solutions

4. Term of Performance

This Contract takes effect as of the Effective Date and continues until completion of the Services, Final Completion and Acceptance of the Work by the City, and closeout, unless terminated earlier or extended pursuant to the terms of this contract. Notwithstanding the foregoing, technology hosting and support services may extend for a term of up to [ten (10)] years, pursuant to the terms and prices set forth in Exhibits 1B and 2C,

respectively.

The City will establish the start and expiration dates at the time of formal award and release of this contract.

5. Payment

1. Basis of Payment

The City will pay Contractor according to the Schedule of Compensation in the attached Exhibit 2 for the completion of the Services in accordance with this Agreement, including the standard of performance found in "Special Conditions for Professional Services Contracts," above.

2. Method of Payment

Contractor must submit monthly invoices to the City for costs billed, as outlined in Section 3.2 Compensation Provisions and/or in the Schedule of Compensation in Exhibit 2. The invoices must be in such detail as the City requests. The City will process payment within 60 days after receipt of invoices and all supporting documentation necessary for the City to verify the Services provided under this Agreement.

3. Criteria for payment

The reasonableness, allocability, and allowability of any costs and expenses charged by Contractor under this contract will be determined by the Commissioner or CIO in their sole discretion.

In the event of a dispute between Contractor and the City as to whether any particular charge will be paid, or as to whether the amount of such charge is reasonable, allocable to the services under the contract, or allowable, the Contractor must, and the Department may, refer such dispute to the CPO for resolution in accordance with the Contract Disputes section of this contract. The City will not withhold payment for undisputed sums on such invoice while a dispute is being resolved.

6. Funding

The source of funds for payments under this Contract is Fund number . Payments under this Agreement must not exceed \$150 Million without a written amendment in accordance with the Amendments section of the "Standard Terms and Conditions" above. Funding for this Contract is subject to the availability of funds and their appropriation by the City Council of the City.

7. Project Phasing and Work Order Assignment

Contractor must perform, on a Work Order basis, the Work required by the LED conversion and stabilization repair scopes of work, in a satisfactory manner consistent with the Chicago Department of Transportation ("CDOT") standards of performance. Such Services will be determined on an as-needed basis and as described in a Work Order Release ("WOR") issued by CDOT. Work Order services may include but are not limited to: (1) LED fixture procurement and installation; and (2) targeted stabilization repairs of existing lighting infrastructure. Contractor will be responsible for technical accuracy; completeness and quality of all planning studies, plans, designs, drawings, specifications, calculations, cost estimates and all other work or materials furnished to CDOT.

All LED conversion and stabilization repair services provided by the Contractor (the "Services") must be authorized by a written WOR. The City is under no obligation to issue any WOR for these Services, nor is Contractor guaranteed any specific dollar value of Services.

CDOT will prepare Work Orders for the LED conversion and stabilization repair Work to be performed under this Contract. CDOT will issue to the Contractor a Work Order in accordance with the procedures outlined in

GSLP Scope of Work and Detailed Specifications

Section 5.7.1. below, "Procedure for Initiating Work Orders." Payment will be based on actual quantities installed, as applicable.

Work Orders are anticipated to primarily be assigned by Project Phase. Each Project Phase will be assigned by geographic areas, composed of various assigned regions, expected to be no smaller than 10 contiguous Atlas Pages or a complete arterial thoroughfare. The City will assign LED conversion and stabilization repair Work to the Contractor through the processes outlined in Sections 5.7.2. and 5.7.3. below.

The Commissioner retains the right, at his or her sole discretion, to delete Work from any Work Order. 5.7.1. Procedure for Initiating

Work Orders

(A) Notification of Pre-Work Meeting: As the need exists for performance of Work by the Contractor under the terms of this Contract, the Commissioner will notify the Contractor of the Work required. The Commissioner will notify the Contractor of the place and time of the joint Pre-Work Meeting.

(B) Joint Pre-Work Meeting: The Contractor will participate in a joint Pre-Work Meeting which will include discussion and/or issue the following information as appropriate:

- (1) Issue Work Order number and title.

- (2) Identify work locations.
 - (3) Define the Scope of Work.
 - (4) Issue engineer's estimate of quantities for work, when available and applicable.
 - (5) Discuss tentative work schedule and completion dates.
 - (6) **Identify due dates for shop drawings for LED Conversion Work Orders. The City will provide geographic areas as stated in Section 5.7 above. The Contractor must provide shop drawings of anticipated conversions within these geographic areas, including fixture types and counts, which shall be subject to the City's approval prior to Work Order Release/Notice to Proceed. However, all LED Conversion Work will be subject to the scopes of work provided within Exhibit 9.**
 - (7) Identify due dates for technical and/or pricing submittals ("Pricing Submittals"), as described in Section 5.7.3., if applicable, for the Work Order Work from the Contractor.
 - (8) Discuss applicable permit requirements.
 - (9) Identify start date for the Work Order Work.
- (C) Review of the Pricing Submittals and Issuance of Work Orders
- (1) For future Phase Work Orders, the Commissioner will evaluate the Contractor's Pricing Submittal in accordance with Section 5.7.3. below before issuing a Work Order Release to _ the Contractor.
 - (2) The Work Order Release provided to the Contractor will state the Description of Work to be performed along with a work schedule. The Work Order Release sets the scope and price for the work to be performed. The Work Order Release must be signed by the Commissioner. A signed copy will be provided to the Contractor.
- (D) Changes in the Work
- (1) The City, without invalidating the Work Order, may order changes in the Work by altering, adding to, or deducting from the Work, by issuing a revised Work Order Notice to Proceed. Contractor must begin the changed work upon receipt of the revised Work Order Notice to Proceed, signed by the Commissioner, unilaterally directing changes in the Work.

CSLP Scope of Work and Detailed Specifications

- (2) No changes may be made without a written revised Work Order Notice to Proceed from the City, signed by the Commissioner.
- (3) Within 14 days of receipt of the written notice from the Commissioner, Contractor must submit to the Commissioner a written request for adjustment to the Contract Price for the revised Work.
- (4) The final provisions of the Proposed Contract Modification, including the adjustment in the Contract Price and/or the Contract time, if any, will be incorporated into a written Contract Modification signed by the City and Contractor.
- (5) All Contract Modifications constitute a full release of the City from any liability for any additional compensation or extension of time arising or resulting from the Work performed pursuant to the Contract Modification. By executing a Contract Modification, Contractor accepts the compensation and/or time extension provided in it in full accord and satisfaction for that Contract Modification, and expressly waives, releases, and relinquishes all additional claims and demands relating to or arising out of the matters covered by that Contract Modification, including direct or indirect cost, profit, or damages related to disruptions.
- (6) Contractor must promptly proceed with any changes in the Work or Contract time as directed by a revised Work Order Notice to Proceed issued by the Commissioner, in accordance with paragraph (1) above, with or without any Contract Modification. Contractor's refusal or failure to proceed promptly with the changed Work as directed constitutes an event of default under the Contract. No change to the Work by Contractor as directed by the Commissioner will operate to invalidate the Contract or release Contractor's surety.

(E) Risk of Loss

- (1) The Work of the Work Order is under Contractor's charge and care until approval by the Commissioner of the following:
 - i. Work Order Substantial Completion;

- ii. Completion of all Punch List Work;
 - iii. Completion of final inspections; and
 - iv. Completion of any equipment testing.
- (2) Contractor assumes all responsibility for injury or damages to the Work of the Work Order by action of the elements, fire or any cause whatsoever, including injury or damage arising from execution or non-execution of the Work. Contractor must rebuild, repair, restore, and make good at no additional cost to the City, all injuries, or damages to any portion of the Work before the approval by the Commissioner as noted above.
- (3) If the Commissioner deems that all Work required pursuant to the Work Order has been completed, the Commissioner will grant Work Order Final Acceptance with respect to the Work completed under that Work Order.

5.7.2. Phase One Work Order Assignment

- (A) LED Fixture Conversion: A Work Order for LED Fixture Conversion is anticipated to be executed following execution of the Contract. Committed Pricing for LED Luminaires for Phase 1 Work will be as detailed in Exhibit 2A - LED Conversion Pricing Form.
- (B) Targeted Infrastructure Stabilization Repairs: A Work Order for the Asset Condition Assessment ("Assessment") is anticipated to be executed with or shortly after execution of the Contract. The Assessment must be completed and provided to the City within 217 calendar days of execution of such Work Order. Further, those portions of the Assessment related to the Atlas Pages assigned to
- (A)

CSLP Scope of Work and Detailed Specifications

the Contractor to be completed in Phase 1 must be completed and provided to the City within 100 calendar days of execution of the Work Order.

As soon as practicable, based on existing data and information gathered through the Assessment, the City will issue a Work Order to the Contractor relating to infrastructure stabilization repair work items to be completed in Phase 1. Committed pricing for infrastructure stabilization repair work will be as detailed in Exhibit 2B - Infrastructure Stabilization Pricing Form.

5.7.3. Work Order Assignments for Future Phases

- (A) LED Fixture Conversion: The process for the assignment of Work Orders for each subsequent Project Phase will be as follows:
- (1) The City will provide the Contractor (i) a list of Atlas Pages ("Phase Atlas List") that define the geographic regions to be completed in that particular Project Phase, and (ii) updated lighting specifications, if the City believes any such updates are required. The Phase Atlas List and updated lighting specifications will be provided no later than 120 calendar days prior to the expected commencement of each respective Project Phase.
 - (2) Final pricing and luminaire selection for all required fixtures for each future Phase will be determined through the process outlined in Section 5.7.4.
 - (3) Once pricing and luminaire selections are finalized and all LED Luminaire submittal(s) are accepted, the City and Contractor shall execute a Work Order for that respective Project Phase, incorporating the accepted LED technical and pricing submittal and Phase Atlas List.
- (B) Targeted Infrastructure Stabilization Repairs: A Work Order relating to infrastructure stabilization repair work to be completed in any Project Phase subsequent to Phase 1 will be provided prior to the expected commencement of each respective Project Phase.

5.7.4. LED Luminaire Pricing and Lighting Specifications for Future Project Phases

LED Luminaire specifications and pricing for future Project Phases will be determined through the process outlined in this Section 5.7.4.

- (A) Within 45 days of receipt of the Phase Atlas List and updated lighting specifications, responsive to the lighting specification provided for each lighting context. Contractor must provide the City one of the following:
- (1) Option 1: A minimum of three competitive luminaire specification technical and pricing submittals, substantially in the form of

Exhibits 15 and 16, as well as a demonstration installation for each of the LED fixture types. Price submittals may include a fixed Contractor markup not to exceed 10% of the cost of the proposed LED Luminaires, which must be provided as a separate line item. However, LED Luminaire prices (inclusive of Contractor markup) may not exceed Phase 1 pricing for any LED Luminaire with materially similar specifications (as determined by the City) during the period ending on the fourth anniversary of the Effective Date; or

- (2) Option 2: An updated technical and pricing submittal only from the LED Manufacturer that has supplied the LED Luminaire used in the preceding Project Phase for such lighting context that (i) conforms to any updates in the lighting specifications, and (ii) is priced,

(1)

CSLP Scope of Work and Detailed Specifications

inclusive of any Contractor markup, at least 10% less than the agreed upon price from the preceding Project Phase.

Only in such instances that a lighting specification(s) provided by the City for any LED Luminaire are materially different (as determined by the City) to the specifications of an LED Luminaire used in the preceding Project Phase for the same lighting context, the Contractor may alternatively choose to provide:

- (3) Option 3: A written request to the City for the opportunity to negotiate a mutually agreed upon price for LED Luminaires meeting any materially changed lighting specifications. Note: the City will enter into negotiations at its discretion and reserves the right to reject such a request for negotiations.*

- (B) If the Contractor elects to provide competitive technical and pricing submittals (Option 1), the City will select one fixture for each applicable fixture type based on an analysis and evaluation to determine best luminaire value within 45 days of submittal receipt, but reserves the right to reject all submittals.
- (C) If the City believes that pricing submittals provided through Option 2 or Option 3 do not reflect competitive market pricing and is otherwise unable to reach mutually agreed upon pricing with the Contractor, the City reserves the right to:
- (1) Require the Contractor to follow the Option 1 procedures and requirements outlined above; and
- (2) Independently solicit technical and pricing submittals for such lighting specifications from third parties ("Third Party Submittals").
- (D) In such instances that the City receives Third Party Submittals that represent pricing at least 10% less than that of the Contractor's submittals responsive to such lighting specifications, the Contractor may elect to proceed in one of the following manners:
- (1) The Contractor may provide updated pricing for its submittal that matches the pricing of the Third Party Submittal, plus a fixed Contractor markup not to exceed 10% of the cost of the proposed LED Luminaires; or
- (2) The Contractor may procure its LED Luminaires from the LED Manufacturer that has provided the City the Third Party Submittal at the terms and pricing that the City has been provided in such Third Party Submittal, plus a fixed Contractor markup not to exceed 10% of the cost of the proposed LED Luminaires.

5.7.5. Additional Details Regarding Pricing of LED Luminaires for Future Phases

If the Contractor achieves a pricing reduction for an LED Luminaire in excess of 10% of the pricing for the LED Luminaire used in the same Lighting Context in the preceding Project Phase, any price reductions in excess of 10% will be shared as follows:

- (A) The City will retain 80% of the cost savings in excess of 10% (and 100% of the cost savings up to 10%)
- (B) The Contractor will be paid 20% of the cost reduction per unit from the prior phase pricing for each LED luminaire ordered in excess of 10% (and 0% of the cost savings up to 10%)

(A)

CSLP Scope of Work and Detailed Specifications

However, in such instances that the Contractor initially provided pricing for a luminaire through Option 2 or Option 3, as outlined in Section 5.7.4., but the City had rejected the initial pricing submittal and final pricing was achieved either by (i) compelling the Contractor to follow Option 1, or (ii) through a Third Party Submittal, the Contractor will not be compensated for any additional savings beyond 10% achieved on the final pricing.

8. Task Orders

The core services associated with the LMS are detailed in Exhibit 1. Task Orders associated with the commissioning of additional hardware or additional technology services, beyond the initial contracted services, may be assigned to the Contractor in future Project Phases pursuant to this Section 5.8. Contractor acknowledges and agrees that the City is under no obligation to issue any Task Orders.

As needed, upon the written approval of the Commissioner and CIO, the Department will issue a Task Order Request ("TOR") specifically referencing this Contract, identifying the project and fund number(s), and setting forth the Services to be performed pursuant to a Task Order and a desired completion date. Contractor must respond by submitting a Task Order Proposal which must include: a cover letter, understanding and approach, project schedule, budget, fee, detailed cost breakdown in such detail as required for the specific task, documentation required to substantiate compliance with MBE/WBE or DBE participation requirements as applicable, a list of key personnel, and any other required information specified in the TOR, all of which must conform to the terms of the TOR and the terms and conditions of this Contract. Contractor must not respond to any TOR not approved in writing by the Commissioner and CIO. Costs associated with the preparation of Task Order proposals are not compensable under this Agreement and the City is not liable for any additional costs.

Following Contractor's submission of the Task Order Proposal, the Commissioner and CIO will review the proposal and may elect to approve it, reject it, or use it as a basis for further negotiations with the Contractor regarding the scope of the project and the project completion date. If the City and the Contractor negotiate the scope of the project and the project completion date, the Contractor must submit a revised Task Order Proposal (based upon such negotiations) to the City for approval. All Task Orders will be subject to the terms and conditions of this Contract and such additional provisions as may be deemed necessary and reasonable by the City.'

All Task Orders are subject to the approval of the Commissioner and CIO, and no Task Order will become binding upon the City until it is approved, in writing, by the Commissioner and CIO. Absent approval of a Task Order by the Commissioner and CIO and issuance of a Purchase Order, the City will not be obligated to pay or have any liability, under any theory of recovery (whether under the Agreement, at law or in equity), to the Contractor for any Services provided by the Contractor pursuant to a Task Order, or otherwise.

9. Notice to Proceed

After receiving a Task Order, Contractor will commence its Services immediately upon receipt of an executed Notice to Proceed issued by the Commissioner and CIO or their authorized designees.

10. Full Discipline Team

For the purposes of this Contract, Contractor must include as part of its team all disciplines necessary to support the required services, including specialized subcontractors, to perform services in fields as required by the project. Contractor shall be aware that, based on the type and scope of the project, not all projects may require a full discipline team, however, in all cases, the Contractor is still required to meet the DBE/MBE/WBE participation requirements on an annual basis. Contractor is responsible for the coordination of all members of its team.

Contractor must, in connection with the performance of the Services, supply all of the personnel, materials, equipment, and/or software necessary to perform the Services and provide any administrative support necessary to satisfactorily perform the Work Order in accordance with the Contract.

11. Performance Bond

5.11.

CSLP Scope of Work and Detailed Specifications

A Performance and Payment Bond is required for this contract.

The Contractor must, within seven calendar days of receipt of written notice from the City, furnish a Performance and Payment Bond in an amount equal to the lesser of (a) \$50 Million or (b) the sum of not-to-exceed budgets for all outstanding Work Orders for the LED Conversion and Infrastructure Stabilization Scopes of Work. Outstanding Work Orders shall mean all Work Orders which have not received Work Order Final Acceptance. Thereafter, anytime a new Work Order is issued, the penal sum of the Bond must be revised to match the lesser of (a) \$50 Million or (b) the sum of not-to-exceed budgets for all then-outstanding Work Orders.

The Bond must be on the Contractor's Performance and Payment Bond form, a specimen which is attached as Exhibit 6, issued by a surety that is satisfactory to the CPO and the City Comptroller, and comply with the provisions of 30 ILCS 550/1 et seq. and MCC Section 2-92-030.

12. Tax Benefits Disclaimer

Contractor agrees that it is not entitled to and will not take any tax position that is inconsistent with being a Contractor to the City with respect to the portion of the Project with respect to which the Contractor provides services. For example, the Contractor agrees not to take any depreciation or amortization, investment tax credit, or deduction for any payment as rent with respect to the Project.

13. City Directed Value Engineering

The City reserves the right to value engineer the Infrastructure Stabilization and LED Conversion Scopes of Work by modifying the Contract Documents to provide innovative, alternative, lower cost construction without impairing the essential functions and characteristics of the Work including, but not limited to, service life, reliability, economy of operation, ease of maintenance, necessary standardized features, desired appearance, or design standards ("City Directed Value Engineering"). The changes will be incorporated into a Contract Modification per Section 5.7.1(D), Changes in the Work. Payment for the Work will be made pursuant to Section 3.2.6., Payment for Changes. For City Directed Value Engineering, the Contractor will not be eligible to receive any Value Engineering Incentive.

14. Value Engineering Proposals

(I) Contractor Value Engineering Proposals. The Contractor may submit to the Commissioner in writing, proposals for modifying the Contract Documents to provide innovative, alternative, lower cost construction without impairing the essential functions and characteristics of the Infrastructure Stabilization and LED Conversion Scopes of Work including, but not limited to, service life, reliability, economy of operation, ease of maintenance, necessary standardized features, desired appearance, or design standards ("Contractor Value Engineering Proposals" or "CVEP").

(A) Proposal Submittal Phases. Contractor Value Engineering Proposals, if any, shall be submitted to the Commissioner in two phases as follows:

(1) Concept Phase. The Contractor shall first submit a brief summary outlining the concept of the proposal to the Commissioner. The Commissioner will notify the Contractor as to whether or not the proposal concept is approved for further consideration as a Contractor Value Engineering Proposal. If it appears, based on the concept, that the actual proposal will require a review period exceeding 21 calendar days, the Contractor will be so advised. Approval of the concept does not constitute or imply approval of the subsequent submittal of the complete Value Engineering Proposal.

CSLP Scope of Work and Detailed Specifications

(2) Complete Proposal Phase. If the concept has been approved, the Contractor, if electing to proceed with submittal of the complete Contractor Value Engineering Proposal, shall submit the proposal to the Commissioner for review. Provided the proposal is complete and contains all the required information for review, the Commissioner will notify the Contractor as to the acceptability of the proposal within a reasonable time after receipt of the proposal, unless additional review time has been established as noted in the concept review process.

(B) Contents of Complete Proposal. Contractor Value Engineering Proposals shall contain the following information:

- (1) A statement that the proposal is being submitted as a Contractor Value Engineering Proposal.
- (2) A complete description detailing the modifications to the Contract Documents needed to implement the proposal.
- (3) A complete cost analysis detailing the unit costs and quantities to be deleted, added and/or revised by the proposal, including an estimate of the anticipated cost savings, specifying any unit price that may be affected by the CVEP and the new proposed unit price associated with such Work item ("CVEP Unit Price").
- (4) A complete analysis of the impact the proposal will have on the prosecution and progress of the Work.

(C) Consideration of Proposals. The following conditions will govern the consideration of Contractor Value Engineering Proposals:

(1) Proposals shall apply only to the Contract under which they are submitted. The Contractor will be guaranteed propriety of authorship

as well as ownership of the proposal until such time it is approved by the Commissioner. Upon approval of the proposal by the Commissioner, the proposal shall become the property of the City. The City will have the right to use, duplicate, and disclose in whole or in part any data necessary for the implementation of the proposal. The City retains the right to use any accepted proposal or part thereof on any other or subsequent contracts without obligation to the Contractor. This provision is not intended to deny rights provided by law with respect to patented materials or processes.

- (2) If the Commissioner has under consideration certain revisions or modifications to the Work at the time of execution of the Contract, the Contractor will be so notified at the preconstruction meeting. Revisions or modifications to the Work generated by the Commissioner shall not be incorporated into any Contractor Value Engineering Proposal submitted by the Contractor.
- (3) Contractor Value Engineering Proposals shall not consist of any experimental products or materials to be incorporated into the Work. However, proposals containing the use of alternate methods and equipment, as allowed by the Contract Documents, may be presented for consideration.
- (4) The reduction of quantities or deletion of items of the Work which result from adjustment of the Contract to meet field conditions, shall not be incorporated into any Contractor Value Engineering Proposal. Proposals based solely on the waiving of specifications or contract requirements will not be considered.

(1)

CSLP Scope of Work and Detailed Specifications

- (5) Contractor shall not implement any changes to the Work pursuant to a Contractor Value Engineering Proposal prior to approval of the proposal by the Commissioner and issuance of a revised Work Order Notice To Proceed pursuant to Section 5.-7.1.
- (6) The Contractor shall have no claim against the City for any costs or delays resulting from the review process and/or disapproval of any Contractor Value Engineering Proposal, including but not limited to, development costs, anticipated profits, increased material cost, and increased labor costs.
- (7) The Commissioner will be the sole judge as to the acceptability of the proposal and the estimated net savings resulting from implementation of the proposal. In determining the estimated net savings, the Commissioner reserves the right to disregard the contract unit prices if the contract prices do not represent the fair measure of the value of the Work to be performed or deleted by the proposal.
- (8) The Commissioner reserves the right, where the Commissioner deems such action appropriate, to require the Contractor to share in the cost of reviewing and investigating any Contractor Value Engineering Proposal. When this requirement is imposed, the Commissioner shall so notify Contractor in the Commissioner's written approval of the Concept phase. In such event, Contractor's decision to proceed with submittal of a complete proposal shall constitute full authority for the Commissioner to deduct amounts payable to the City from any monies due or that may become due to the Contractor under the Contract.
- (9) The Contractor shall be responsible for drafting any modification of the Contract Documents required as part of the Contractor Value Engineering Proposal. When Contract Document modifications are included as part of the proposal, the Contractor shall furnish a copy of the modifications to the Commissioner and shall be solely responsible for any errors or omissions resulting from the modification.

(II) Acceptance of the Proposal: If a Contractor Value Engineering Proposal is accepted, the changes will be incorporated into a Contract Modification per Section 5.7.1.(D), Changes in the Work.

(III) Engineering Basis of Payment. In addition to payment for the Work, as modified, if the VECP is accepted the Contractor will be entitled to share in 25% of any unit price reduction. Accordingly, the Contract will be modified to authorize the changes to relevant Contract provisions and specifications. New unit prices, utilizing the CVEP Unit Price and allowing for a 25% share of the savings, will be accepted and calculated as follows:

$$\text{New Contract Unit Price} = \text{CVEP Unit Price} + 25\% * (\text{Proposal Unit Price} - \text{CVEP Unit Price})$$

CSLP Scope of Work and Detailed Specifications

**CITY OF CHICAGO Department of Procurement
Services Jamie L. Rhee, Chief Procurement Officer
121 North LaSalle Street, Room 806 Chicago,
Illinois 60602-1284**

Fax: 312-744-3281

MBE & WBE SPECIAL CONDITIONS FOR CONSTRUCTION CONTRACTS

ARTICLE 6. SPECIAL CONDITIONS REGARDING MINORITY BUSINESS ENTERPRISE COMMITMENT AND WOMEN BUSINESS ENTERPRISE COMMITMENT IN CONSTRUCTION CONTRACTS

I. Policy and Terms

As set forth in 2-92-650 et seq. of the Municipal Code of Chicago (MCC) it is the policy of the City of Chicago that businesses certified as Minority Owned Business Enterprises (MBEs) and Women Owned Business Enterprises (WBEs) in accordance with Section 2-92-420 et seq. of the MCC and Regulations Governing Certification of Minority and Women-owned Businesses, and all other Regulations promulgated under the aforementioned sections of the Municipal Code, as well as MBEs and WBEs certified by Cook County, Illinois, shall have full and fair opportunities to participate fully in the performance of this contract. Therefore, bidders shall not discriminate against any person or business on the basis of race, color, national origin, or sex, and shall take affirmative actions to ensure that MBEs and WBEs shall have full and fair opportunities to compete for and perform subcontracts for supplies or services.

Failure to carry out the commitments and policies set forth herein shall constitute a material breach of the contract and may result in the termination of the contract or such remedy as the City of Chicago deems appropriate.

Under the City's MBE/WBE Construction Program as set forth in MCC 2-92-650 et seq, the program-wide aspirational goals are 26% Minority Owned Business Enterprise participation and 6% Women Owned Business Enterprise participation. The City has set goals of 26% and 6% on all contracts in line with its overall aspirational goals, unless otherwise specified herein, and is requiring that bidders make a good faith effort in meeting or exceeding these goals.

Pursuant to MCC 2-92-535, the prime contractor may apply be awarded an additional 0.5 percent credit, up to a maximum of a total of 5 percent additional credit, for every 1 percent of the value of a contract self-performed by MBEs or WBEs, or combination thereof, that have entered into a mentoring agreement with the contractor or subcontractor-to-subcontractor mentoring agreement. This up to 5% may be applied to the Contract Specific Goals, or it may be in addition to the Contract Specific Goals.

II. Contract Specific Goals and Bids

A bid may be rejected as non-responsive if it fails to submit one or more of the following with its bid demonstrating its good faith efforts to meet the Contract Specific Goals by reaching out to MBEs and WBEs to perform work on the contract:

- A. An MBE/WBE compliance plan demonstrating how the bidder plans to meet the Contract Specific Goals (Schedule D); and/or

MBE and WBE Special Conditions

- B. Documentation of Good Faith Efforts (Schedule H).

If a bidder's compliance plan falls short of the Contract Specific Goals, the bidder must include either a Schedule H demonstrating that it has made Good Faith Efforts to find MBE and WBE firms to participate or a request for a reduction or waiver of the goals.

Accordingly, the bidder or contractor commits to make good faith efforts to expend at least the following percentages of the total contract price (inclusive of any and all modifications and amendments), if awarded the contract:

MBE Contract Specific Goal: 26%

WBE Contract Specific Goal: 6%

This Contract Specific Goal provision shall supersede any conflicting language or provisions that may be contained in this document.

For purposes of evaluating the bidder's responsiveness, the MBE and WBE Contract Specific Goals shall be percentages of the bidder's total base bid. However, the MBE and WBE Contract Specific Goals shall apply to the total value of this contract, including all amendments and modifications.

III. **Contract Specific Goals and Contract Modifications**

1. The MBE and WBE Contract Specific Goals established at the time of contract bid shall also apply to any modifications to the Contract after award. That is, any additional work and/or money added to the Contract must also adhere to these Special Conditions requiring Contractor to (sub)contract with MBEs and WBEs to meet the Contract Specific Goals.

- a. Contractor must assist the Construction Manager or user Department in preparing its "proposed contract modification" by evaluating the subject matter of the modification and determining whether there are opportunities for MBE or WBE participation and at what rates.
- b. Contractor must produce a statement listing the MBEs/WBEs that will be utilized on any contract modification. The statement must include the percentage of utilization of the firms. If no MBE/WBE participation is available, an explanation of good faith efforts to obtain participation must be included.

2. The Chief Procurement Officer shall review each proposed contract modification and amendment that by itself or aggregated with previous modification/amendment requests, increases the contract value by ten percent (10%) of the initial award, or \$50,000, whichever is less, for opportunities to increase the participation of MBEs or WBEs already involved in the Contract.

IV. **Definitions**

"Area of Specialty" means the description of a MBE's or WBE's activity that has been determined by the Chief Procurement Officer to be most reflective of the firm's claimed specialty or expertise. Each MBE and WBE letter of certification contains a description of the firm's Area of Specialty. Credit toward the Contract Specific Goals shall be limited to the participation of firms performing within their Area of Specialty. The Department of Procurement Services does not make any representation concerning the ability of any MBE or WBE to perform work within its Area of Specialty. It is the responsibility of the bidder or contractor to determine the capability and capacity of MBEs and WBEs to perform the work proposed.

"B.E.P.D." means an entity certified as a Business enterprise owned or operated by people with disabilities as defined in MCC 2-92-586.

MBE and WBE Special Conditions

"Broker" means a person or entity that fills orders by purchasing or receiving supplies from a third party supplier rather than out of its own existing inventory and provides no commercially useful function other than acting as a conduit between his or her supplier and his or her

customer.

"Chief Procurement Officer" or "CPO" means the chief procurement officer of the City of Chicago or his or her designee.

"Commercially Useful Function" means responsibility for the execution of a distinct element of the work of the contract, which is carried out by actually performing, managing, and supervising the work involved, evidencing the responsibilities and risks of a business owner such as negotiating the terms of (sub)contracts, taking on a financial risk commensurate with the contract or its subcontract, responsibility for acquiring the appropriate lines of credit and/or loans, or fulfilling responsibilities as a joint venture partner as described in the joint venture agreement.

"Construction Contract" means a contract, purchase order or agreement (other than lease of real property) for the construction, repair, or improvement of any building, bridge, roadway, sidewalk, alley, railroad or other structure or infrastructure, awarded by any officer or agency of the City, other than the City Council, and whose cost is to be paid from City funds.

"Contract Specific Goals" means the subcontracting goals for MBE and WBE participation established for a particular contract.

"Contractor" means any person or business entity that has entered into a construction contract with the City, and includes all partners, affiliates and joint ventures of such person or entity.

"Direct Participation" the value of payments made to MBE or WBE firms for work that is done in their Area of Specialty directly related to the performance of the subject matter of the Construction Contract will count as Direct Participation toward the Contract Specific Goals.

"Directory" means the Directory of Minority Business MBEs and WBEs maintained and published by the Chief Procurement Officer. The Directory identifies firms that have been certified as MBEs and WBEs, and includes the date of their last certifications and the areas of specialty in which they have been certified. Bidders and contractors are responsible for verifying the current certification status of all proposed MBEs and WBEs.

"Executive Director" means the executive director of the Office of Compliance or his or her designee.

"Good Faith Efforts" means actions undertaken by a bidder or contractor to achieve a Contract Specific Goal that, by their scope, intensity, and appropriateness to the objective, can reasonably be expected to fulfill the program's requirements.

"Joint venture" means an association of a MBE or WBE firm and one or more other firms to carry out a single, for-profit business enterprise, for which each joint venture partner contributes property, capital, efforts, skills and knowledge, and in which the MBE or WBE is responsible for a distinct, clearly defined portion of the work of the contract and whose share in the capital contribution, control, management, risks, and profits of the joint venture are commensurate with its ownership interest.

"Mentor-Protégé Agreement" means an agreement between a prime and MBE or WBE subcontractor ("Mentoring Agreement"), or an agreement between a prime's subcontractor and MBE or WBE subcontractor ("Subcontractor-to-Subcontractor Mentoring Agreement"), pursuant to MCC 2-92-535, that is approved by the City of Chicago and complies with all requirements of MCC 2-92-535 and any rules and regulations promulgated by the Chief Procurement Officer

MBE and WBE Special Conditions

Oiv rundc-j Plofci'-.cr.ol Sc-r.-ic--h i.-.ifc .V: -rz

"Minority Business Enterprise" or "MBE" means a firm certified as a minority-owned business enterprise in accordance with City Ordinances and Regulations as well as a firm awarded certification as a minority owned and controlled business by Cook County, Illinois.

"Supplier" or "Distributor" refers to a company that owns, operates, or maintains a store, warehouse or other establishment in which materials, supplies, articles or equipment are bought, kept in stock and regularly sold or leased to the public in the usual course of business. A regular distributor or supplier is a firm that owns, operates, or maintains a store, warehouse, or other establishment in which the materials or supplies required for performance of the Contract are bought, kept in stock, and regularly sold to the public in the usual course of business. To be a regular distributor the firm must engage in, as its principal business and in its own name, the purchase and sale of the products in question. A

regular distributor in such bulk items as steel, cement, gravel, stone, and petroleum products need not keep such products in stock if it owns or operates distribution equipment.

"Women Business Enterprise" or "WBE" means a firm certified as a women-owned business enterprise in accordance with City Ordinances and Regulations as well as a firm awarded certification as a women owned business by Cook County, Illinois.

V. Joint Ventures

The formation of joint ventures to provide MBEs and WBEs with capacity and experience at the prime contracting level, and thereby meet Contract Specific Goals (in whole or in part) is encouraged. A joint venture may consist of any combination of MBEs, WBEs, and non-certified firms as long as one member is an MBE or WBE.

A. The joint venture may be eligible for credit towards the Contract Specific Goals only if:

1. The MBE or WBE joint venture partner's share in the capital contribution, control, management, risks and profits of the joint venture is equal to its ownership interest;
2. The MBE or WBE joint venture partner is responsible for a distinct, clearly defined portion of the requirements of the contract for which it is at risk;
3. Each joint venture partner executes the bid to the City; and
4. The joint venture partners have entered into a written agreement specifying the terms and conditions of the relationship between the partners and their relationship and responsibilities to the contract, and all such terms and conditions are in accordance with the conditions set forth in Items 1, 2, and 3 above in this Paragraph A.

B. The Chief Procurement Officer shall evaluate the proposed joint venture agreement, the Schedule B submitted on behalf of the proposed joint venture, and all related documents to determine whether these requirements have been satisfied. The Chief Procurement Officer shall also consider the record of the joint venture partners on other City of Chicago contracts. The decision of the Chief Procurement Officer regarding the eligibility of the joint venture for credit towards meeting the Contract Specific Goals, and the portion of those goals met by the joint venture, shall be final.

The joint venture may receive MBE or WBE credit for work performed by the MBE or WBE joint venture partner(s) equal to the value of work performed by the MBE or WBE with its own forces for a distinct, clearly defined portion of the work

Additionally, if employees of the joint venture entity itself (as opposed to employees of the MBE or WBE partner) perform the work then the value of the work may be counted toward the Contract Specific Goals at a rate equal to the MBE or WBE firm's percentage of participation in the joint venture as described in Schedule B.

MBE and WBE Special Conditions 100

The Chief Procurement Officer may also count the dollar value of work subcontracted to other MBEs and WBEs. Work performed by the forces of a non-certified joint venture partner shall not be counted toward the Contract Specific Goals.

C. Schedule B: MBE/WBE Affidavit of Joint Venture

Where the bidder's Compliance Plan includes the participation of any MBE or WBE as a joint venture partner, the bidder must submit with its bid a Schedule B and the proposed joint venture agreement. These documents must both clearly evidence that the MBE or WBE joint venture partner(s) will be responsible for a clearly defined portion of the work to be performed, and that the MBE's or WBE's responsibilities and risks are proportionate to its ownership percentage. The proposed joint venture agreement must include specific details related to:

1. The parties' contributions of capital, personnel, and equipment and share of the costs of insurance and bonding;
2. Work items to be performed by the MBE's or WBE's own forces and/or work to be performed by employees of the newly

formed joint venture entity;

3. Work items to be performed under the supervision of the MBE or WBE joint venture partner; and
4. The MBE's or WBE's commitment of management, supervisory, and operative personnel to the performance of the contract.

NOTE: Vague, general descriptions of the responsibilities of the MBE or WBE joint venture partner do not provide any basis for awarding credit. For example, descriptions such as "participate in the budgeting process," "assist with hiring," or "work with managers to improve customer service" do not identify distinct, clearly defined portions of the work. Roles assigned should require activities that are performed on a regular, recurring basis rather than as needed. The roles must also be pertinent to the nature of the business for which credit is being sought. For instance, if the scope of work required by the City entails the delivery of goods or services to various sites in the City, stating that the MBE or WBE joint venture partner will be responsible for the performance of all routine maintenance and all repairs required to the vehicles used to deliver such goods or services is pertinent to the nature of the business for which credit is being sought.

VI. Counting MBE and WBE Participation Towards the Contract Specific Goals

Refer to this section when preparing the MBE/WBE compliance plan and completing Schedule D for guidance on what value of the participation by MBEs and WBEs will be counted toward the stated Contract Specific Goals. The "Percent Amount of Participation" depends on whether and with whom a MBE or WBE subcontracts out any portion of its work and other factors.

Firms that are certified as both MBE and WBE may only be listed on a bidder's compliance plan as either a MBE or a WBE to demonstrate compliance with the Contract Specific Goals. For example, a firm certified as both a MBE and a WBE may only be listed on the bidder's compliance plan under one of the categories, but not both. Additionally, a firm that is certified as both a MBE and a WBE could not self-perform 100% of a contract, it would have to show good faith efforts to meet the Contract Specific Goals by including in its compliance plan work to be

MBE and WBE Special Conditions

OIM rtfia'cj i'^ofci'^cnai <i r'^k with Worx

performed by another MBE or WBE firm, depending on which certification that dual-certified firm chooses to count itself as.

- A. Only expenditures to firms that perform a Commercially Useful Function as defined above may count toward the Contract Specific Goals.
 1. The CPO will determine whether a firm is performing a commercially useful function by evaluating the amount of work subcontracted, whether the amount the firm is to be paid under the contract is commensurate with the work it is actually performing and the credit claimed for its performance of the work, industry practices, and other relevant factors.
 2. A MBE or WBE does not perform a commercially useful function if its participation is only required to receive payments in order to obtain the appearance of MBE or WBE participation. The CPO may examine similar commercial transactions, particularly those in which MBEs or WBEs do not participate, to determine whether non MBE and non WBE firms perform the same function in the marketplace to make a determination.
- B. Only the value of the dollars paid to the MBE or WBE firm for work that it performs in its Area of Specialty in which it is certified counts toward the Contract Specific Goals.

Only payments made to MBE and WBE firms that meet BOTH the Commercially Useful Function and Area of Specialty requirements above will be counted toward the Contract Specific Goals.

- C. If the MBE or WBE performs the work itself:
 1. 100% of the value of work actually performed by the MBE's or WBE's own forces shall be counted toward the Contract Specific Goals, including the cost of supplies purchased or equipment leased by the MBE or WBE from third parties or second tier subcontractors in order to perform its (sub)contract with its own forces. 0% of the value of work at the project site that a MBE or WBE subcontracts to a non-certified firm counts toward the Contract Specific Goals

- D. If the MBE or WBE is a manufacturer:
 - 1. 100% of expenditures to a MBE or WBE manufacturer for items needed for the Contract shall be counted toward the Contract Specific Goals. A manufacturer is a firm that operates or maintains a factory or establishment that produces on the premises the materials or supplies obtained by the bidder or contractor.
- E. If the MBE or WBE is a distributor or supplier:
 - 1. 60% of expenditures for materials and supplies purchased from a MBE or WBE that is certified as a regular dealer or supplier shall be counted toward the Contract Specific Goals.
- F. If the MBE or WBE is a broker:
 - 1. 0% of expenditures paid to brokers will be counted toward the Contract Specific Goals.
 - 2. As defined above, Brokers provide no commercially useful function.
- G. If the MBE or WBE is a member of the joint venture contractor/bidder:
 - 1. A joint venture may count the portion of the total dollar value of the contract equal to the distinct, clearly defined portion of the work of the contract that the MBE or WBE performs with its own forces toward the Contract Specific Goals.
 - i. OR if employees of this distinct joint venture entity perform the work then the value of the work may be counted toward the Contract Specific Goals at a rate equal to the MBE or WBE firm's percentage of participation in the joint venture as described in Schedule B.
 - 2. Note: a joint venture may also count the dollar value of work subcontracted to other MBEs and WBEs, however, work subcontracted out to non-certified firms may not be counted.

2.

MBE and WBE Special Conditions

- H. If the MBE or WBE subcontracts out any of its work:
 - 1. 100% of the value of the work subcontracted to other MBEs or WBEs performing work in its Area of Specialty may be counted toward the Contract Specific Goals.
 - 2. 0% of the value of work that a MBE or WBE subcontracts to a non-certified firm counts toward the Contract Specific Goals (except for the cost of supplies purchased or equipment leased by the MBE or WBE from third parties or second tier subcontractors in order to perform its (sub)contract with its own forces as allowed by C.I. above).
 - 3. The fees or commissions charged for providing a bona fide service, such as professional, technical, consulting or managerial services or for providing bonds or insurance or the procurement of essential personnel, facilities, equipment, materials or supplies required for performance of the Contract, may be counted toward the Contract Specific Goals, provided that the fee or commission is determined by the Chief Procurement Officer to be reasonable and not excessive as compared with fees customarily allowed for similar services.
 - 4. The fees charged for delivery of materials and supplies required on a job site (but not the cost of the materials and supplies themselves) when the hauler, trucker, or delivery service is not also the manufacturer of or a regular dealer in the materials and supplies, provided that the fee is determined by the Chief Procurement Officer to be reasonable and not excessive as compared with fees customarily allowed for similar services.
 - 5. The fees or commissions charged for providing any bonds or insurance, but not the cost of the premium itself, specifically required for the performance of the Contract, provided that the fee or commission is determined by the Chief Procurement Officer to be reasonable and not excessive as compared with fees customarily allowed for similar services.

VII. Procedure to Determine Bid Compliance

The following Schedules and requirements govern the bidder's or contractor's MBE/WBE proposal:

- a. Schedule B: MBE/WBE Affidavit of Joint Venture
 - i. Where the bidder's Compliance Plan includes the participation of any MBE or WBE as a joint venture partner, the bidder must submit with its bid a Schedule B and the proposed joint venture agreement. See Section III above for detailed requirements.
- b. Schedule C

The bidder must submit the appropriate Schedule C with the bid for each MBE and WBE included on the Schedule D. The City encourages subcontractors to utilize the electronic fillable format Schedule C, which is available at the Department of Procurement Services website, <<http://cityofchicago.org/forms>>. Suppliers must submit the Schedule C for Suppliers, first tier subcontractors must submit a Schedule C for Subcontractors to the Prime Contractor and second or lower tier subcontractors must submit a Schedule C for second tier Subcontractors. Each Schedule C must accurately detail the work to be performed by the MBE or WBE and the agreed upon rates/prices. Each Schedule C must also include a separate sheet as an attachment on which the MBE or WBE fully describes its proposed scope of work, including a description of the commercially useful function being performed by the MBE or WBE in its Area of Specialty. If a facsimile copy of the Schedule C has been submitted with the bid, an executed original Schedule C must be submitted by the bidder for each MBE and WBE included on the Schedule D within five (5) business days after the date of the bid opening.

- c. Schedule D: Compliance Plan Regarding MBE and WBE Utilization

MBE and WBE Special Conditions

The bidder must submit a Schedule D with the bid. The City encourages bidders to utilize the electronic Tillable format Schedule D, which is available at the Department of Procurement Services website, <<http://cityofchicago.org/forms>>. An approved Compliance Plan is required before a contract may commence.

The Compliance Plan must commit to the utilization of each listed MBE and WBE. The bidder is responsible for calculating the dollar equivalent of the MBE and WBE Contract Specific Goals as percentages of the total base bid. All Compliance Plan commitments must conform to the Schedule Cs.

A bidder or contractor may not modify its Compliance Plan after bid opening except as directed by the Department of Procurement Services to correct minor errors or omissions. Bidders shall not be permitted to add MBEs or WBEs after bid opening to meet the Contract Specific Goals, however, contractors are encouraged to add additional MBE/WBE vendors to their approved compliance plan during the performance of the contract when additional opportunities for participation are identified. Except in cases where substantial, documented justification is provided, the bidder or contractor shall not reduce the dollar commitment made to any MBE or WBE in order to achieve conformity between the Schedule Cs and Schedule D. All terms and conditions for MBE and WBE participation on the contract must be negotiated and agreed to between the bidder or contractor and the MBE or WBE prior to the submission of the Compliance Plan. If a proposed MBE or WBE ceases to be available after submission of the Compliance Plan, the bidder or contractor must comply with the provisions in Section VII.

- d. Letters of Certification

A copy of each proposed MBE's and WBE's Letter of Certification from the City of Chicago or Cook County, Illinois, must be submitted with the bid.

Letters of Certification includes a statement of the MBE's or WBE's area(s) of specialty. The MBE's or WBE's scope of work as detailed in the Schedule C must conform to its area(s) of specialty. Where a MBE or WBE is proposed to perform work not covered by its Letter of Certification, the MBE or WBE must request the addition of a new area at least 30 calendar days prior to the bid opening.

- e. Schedule F: Report of Subcontractor Solicitations for Construction Contracts

A Schedule F must be submitted with the bid, documenting all subcontractors and suppliers solicited for participation on the contract by the bidder. Failure to submit the Schedule F may render the bid non-responsive.

- f. Schedule H: Documentation of Good Faith Efforts to Utilize MBEs and WBEs on Construction Contract

- i. If a bidder determines that it is unable to meet the Contract Specific Goals, it must document its good faith efforts to do so, including the submission of Schedule C, Log of Contacts.

- ii. If the bidder's Compliance Plan demonstrates that it has not met the Contract Specific Goals in full or in part, the bidder must submit its Schedule H no later than three business days after notification by the Chief Procurement Officer of its status as the

apparent lowest bidder. Failure to submit a complete Schedule H will cause the bid to be rejected as non-responsive.

i.

MBE and WBE Special Conditions

iii. Documentation must include but is not necessarily limited to:

1. A detailed statement of efforts to identify and select portions of work identified in the bid solicitation for subcontracting to MBEs and WBEs;

2. A listing of all MBEs and WBEs contacted for the bid solicitation that includes:

- a. Names, addresses, emails and telephone numbers of firms solicited;
- b. Date and time of contact;
- c. Person contacted;
- d. Method of contact (letter, telephone call, facsimile, electronic mail, etc.).

3. Evidence of contact, including:

- a. Project identification and location;
- b. Classification/commodity of work items for which quotations were sought;
- c. Date, item, and location for acceptance of subcontractor bids;
- d. Detailed statements summarizing direct negotiations with appropriate MBEs and WBEs for specific portions of the work and indicating why agreements were not reached.
- e. Bids received from all subcontractors.

4. Documentation of bidder or contractor contacts with at least one of the minority and women assistance associations on Attachment A.

g. Agreements between a bidder or contractor and a MBE or WBE in which the MBE or WBE promises not to provide subcontracting quotations to other bidders or contractors are prohibited.

h. Prior to award, the bidder agrees to promptly cooperate with the Department of Procurement Services in submitting to interviews, allowing entry to places of business, providing further documentation, or soliciting the cooperation of a proposed MBE or WBE. Failure to cooperate may render the bid non-responsive.

i. If the City determines that the Compliance Plan contains minor errors or omissions, the bidder or contractor must submit a revised Compliance Plan within five (5) business days after notification by the City that remedies the minor errors or omissions. Failure to correct all minor errors or omissions may result in the determination that a bid is non-responsive.

j. No later than three (3) business days after receipt of the executed contract, the contractor must execute a complete subcontract agreement or purchase order with each MBE and WBE listed in the Compliance Plan. No later than eight (8) business days after receipt of the executed contract, the contractor must provide copies of each signed subcontract, purchase order, or other agreement to the Department of Procurement Services.

VIII. Demonstration of Good Faith Efforts

a. In evaluating the Schedule H to determine whether the bidder or contractor has made good faith efforts, the performance of other bidders or contractors in meeting the goals may be considered.

b. The Chief Procurement Officer shall consider, at a minimum, the bidder's efforts to:

- i. Solicit through reasonable and available means at least 50% (or at least five when there are more than eleven certified firms in the commodity area) of MBEs and WBEs certified in the anticipated scopes of subcontracting of the contract, as documented by the Schedule H. The bidder or contractor must solicit MBEs and WBEs within seven (7) days prior to the date bids are due. The bidder or contractor must take appropriate steps to follow up initial solicitations with interested MBEs or WBEs.

MBE and WBE Special Conditions

Advertise the contract opportunities in media and other venues oriented toward MBEs and WBEs.

- iii. Provide interested MBEs or WBEs with adequate information about the plans, specifications, and requirements of the contract, including addenda, in a timely manner to assist them in responding to the solicitation.
 - iv. Negotiate in good faith with interested MBEs or WBEs that have submitted bids. That there may be some additional costs involved in soliciting and using MBEs and WBEs is not a sufficient reason for a bidder's failure to meet the Contract Specific Goals, as long as such costs are reasonable.
 - v. Not reject MBEs or WBEs as being unqualified without sound reasons based on a thorough investigation of their capabilities. The MBE's or WBE's standing within its industry, membership in specific groups, organizations, or associations and political or social affiliations are not legitimate causes for rejecting or not soliciting bids to meet the Contract Specific Goals.
 - vi. Make a portion of the work available to MBE or WBE subcontractors and suppliers and selecting those portions of the work or material consistent with the available MBE or WBE subcontractors and suppliers, so as to facilitate meeting the Contract Specific Goals.
 - vii. Make good faith efforts, despite the ability or desire of a bidder or contractor to perform the work of a contract with its own organization. A bidder or contractor who desires to self-perform the work of a contract must demonstrate good faith efforts unless the Contract Specific Goals have been met.
 - viii. Select portions of the work to be performed by MBEs or WBEs in order to increase the likelihood that the goals will be met. This includes, where appropriate, breaking out contract work items into economically feasible units to facilitate MBE or WBE participation, even when the bidder or contractor might otherwise prefer to perform these work items with its own forces.
 - ix. Make efforts to assist interested MBEs or WBEs in obtaining bonding, lines of credit, or insurance as required by the City or bidder or contractor.
 - x. Make efforts to assist interested MBEs or WBEs in obtaining necessary equipment, supplies, materials, or related assistance or services; and
 - xi. Effectively use the services of the City; minority or women community organizations; minority or women assistance groups; local, state, and federal minority or women business assistance offices; and other organizations to provide assistance in the recruitment and placement of MBEs or WBEs.
- c. If the bidder disagrees with the City's determination that it did not make good faith efforts, the bidder may file a protest pursuant to the Department of Procurement Services Solicitation and Contracting Process Protest Procedures within 10 business days of a final adverse decision by the Chief Procurement Officer.

IX. Changes to Compliance Plan

a. No changes to the Compliance Plan or contractual MBE and WBE commitments or substitution of MBE or WBE subcontractors may be made without the prior written approval of the Chief Procurement Officer. Unauthorized changes or substitutions, including performing the work designated for a subcontractor with the contractor's own forces, shall be a violation of these Special Conditions and a breach of the contract with the City, and may cause termination of the executed Contract for breach, and/or subject the bidder or contractor to contract remedies or other sanctions. The facts supporting the request for changes must not have been known nor reasonably could have been known by the parties prior to entering into the subcontract. Bid shopping is prohibited. The bidder or contractor must negotiate with the subcontractor to resolve the problem. MBE and WBE Special Conditions 106

If requested by either party, the Department of Procurement Services shall facilitate such a meeting. Where there has been a

mistake or disagreement about the scope of work, the MBE or WBE can be substituted only where an agreement cannot be reached for a reasonable price for the correct scope of work.

- b. Substitutions of a MBE or WBE subcontractor shall be permitted only on the following basis:
 - i. Unavailability after receipt of reasonable notice to proceed;
 - ii. Failure of performance;
 - iii. Financial incapacity;
 - iv. Refusal by the subcontractor to honor the bid or proposal price or scope;
 - v. Mistake of fact or law about the elements of the scope of work of a solicitation where a reasonable price cannot be agreed;
 - vi. Failure of the subcontractor to meet insurance, licensing or bonding requirements;
 - vii. The subcontractor's withdrawal of its bid or proposal; or
 - viii. De-certification of the subcontractor as a MBE or WBE. (Graduation from the MBE/WBE program does not constitute de-certification.

- c. If it becomes necessary to substitute a MBE or WBE or otherwise change the Compliance Plan, the procedure will be as follows:
 - i. The bidder or contractor must notify the Chief Procurement Officer in writing of the request to substitute a MBE or WBE or otherwise change the Compliance Plan. The request must state specific reasons for the substitution or change. A letter from the MBE or WBE to be substituted or affected by the change stating that it cannot perform on the contract or that it agrees with the change in its scope of work must be submitted with the request.
 - ii. The City will approve or deny a request for substitution or other change within 15 business days of receipt of the request.
 - iii. Where the bidder or contractor has established the basis for the substitution to the satisfaction of the Chief Procurement Officer, it must make good faith efforts to meet the Contract Specific Goal by substituting a MBE or WBE subcontractor. Documentation of a replacement MBE or WBE, or of good faith efforts, must meet the requirements in sections V and VI. If the MBE or WBE Contract Specific Goal cannot be reached and good faith efforts have been made, as determined by the Chief Procurement Officer, the bidder or contractor may substitute with a non-MBE or non-WBE.
 - iv. If a bidder or contractor plans to hire a subcontractor for any scope of work that was not previously disclosed in the Compliance Plan, the bidder or contractor must obtain the approval of the Chief Procurement Officer to modify the Compliance Plan and must make good faith efforts to ensure that MBEs or WBEs have a fair opportunity to bid on the new scope of work.
 - v. A new subcontract must be executed and submitted to the Chief Procurement Officer within five business days of the bidder's or contractor's receipt of City approval for the substitution or other change.

- d. The City shall not be required to approve extra payment for escalated costs incurred by the contractor when a substitution of subcontractors becomes necessary to comply with MBE/WBE contract requirements.

X. Reporting and Record Keeping

- a. During the term of the contract, the contractor and its non-certified subcontractors must submit partial and final waivers of lien from MBE and WBE subcontractors that show the accurate cumulative dollar

MBE and WBE Special Conditions _f7

amount of subcontractor payments made to date. Upon acceptance of the Final Quantities from the City of Chicago, FINAL certified waivers of lien from the MBE and WBE subcontractors must be attached to the contractor's acceptance letter and forwarded to the Department of Procurement Services, Attention: Chief Procurement Officer.

- b. The contractor will be responsible for reporting payments to all subcontractors on a monthly basis in the form of an electronic audit. Upon the first payment issued by the City of Chicago to the contractor for services performed, on the first day of each month and every month thereafter, email and/or fax audit notifications will be sent out to the contractor with instructions to report payments that have been made in the prior month to each MBE and WBE. The reporting of payments to all

subcontractors must be entered into the Certification and Compliance Monitoring System (C2), or whatever reporting system is currently in place, or compatible structure that can be uploaded into C2 or City's current system, on or before the fifteenth (15th) day of each month. For purposes of this Contract, all subsequent references to C2 shall mean C2, or the City's current system, or a compatible structure that can be uploaded into C2 or City's current system, unless the context provides otherwise.

Once the prime contractor has reported payments made to each MBE and WBE, including zero dollar amount payments, the MBE and WBE will receive an email and/or fax notification requesting them to log into the system and confirm payments received. All monthly confirmations must be reported on or before the 20th day of each month. Contractor and subcontractor reporting to the C2 system must be completed by the 25th of each month or payments may be withheld.

All subcontract agreements between the contractor and MBE/WBE firms or any first tier non-certified firm and lower tier MBE/WBE firms must contain language requiring the MBE/WBE to respond to email and/or fax notifications from the City of Chicago requiring them to report payments received for the prime or the non-certified firm.

Access to the Certification and Compliance Monitoring System (C2), which is a web based reporting system, can be found at: <<http://chicago.inwdb.com>>

- c. The Chief Procurement Officer or any party designated by the, Chief Procurement Officer shall have access to the contractor's books and records, including without limitation payroll records, tax returns and records and books of account, to determine the contractor's compliance with its commitment to MBE and WBE participation and the status of any MBE or WBE performing any portion of the contract. This provision shall be in addition to, and not a substitute for, any other provision allowing inspection of the contractor's records by any officer or official of the City for any purpose.
- d. The contractor shall maintain records of all relevant data with respect to the utilization of MBEs and WBEs, retaining these records for a period of at least five years after final acceptance of the work. Full access to these records shall be granted to City, federal or state authorities or other authorized persons.

XI. Non-Compliance

- a. Without limitation, the following shall constitute a material breach of this contract and entitle the City to declare a default, terminate the contract, and exercise those remedies provided for in the contract at law or in equity: (1) failure to demonstrate good faith efforts; and (2) disqualification as a MBE or WBE of the contractor or any joint venture partner, subcontractor or supplier if its status as an MBE or WBE was a factor in the award of the contract and such status was misrepresented by the contractor.
 - b. Payments due to the contractor may be withheld until corrective action is taken.
- a.

MBE and WBE Special Conditions

- c. Pursuant to 2-92-740, remedies or sanctions may include disqualification from contracting or subcontracting on additional City contracts for up to three years, and the amount of the discrepancy between the amount of the commitment in the Compliance Plan, as such amount may be amended through change orders or otherwise over the term of the contract, and the amount paid to MBEs or WBEs. The consequences provided herein shall be in addition to any other criminal or civil liability to which such entities may be subject.
- d. The contractor shall have the right to protest the final determination of noncompliance and the imposition of any penalty by the Chief Procurement Officer pursuant to 2-92-740 of the Municipal Code of the City of Chicago, within 15 business days of the final determination.

XII. Arbitration

If the City determines that a contractor has not made good faith efforts to fulfill its Compliance Plan, the affected MBE or WBE may recover damages from the contractor.

Disputes between the contractor and the MBE or WBE shall be resolved by binding arbitration before the American Arbitration Association (AAA), with reasonable expenses, including attorney's fees and arbitrator's fees, being recoverable by a prevailing MBE or WBE. Participation in such arbitration is a material provision of the Construction Contract to which these Special Conditions are an Exhibit. This provision is intended for the benefit of any MBE or WBE affected by the contractor's failure to fulfill its Compliance Plan and grants such entity specific third party beneficiary rights. These rights are non-waivable and take precedence over any agreement to the contrary, including but not limited to those contained in a subcontract, suborder, or communicated orally between a contractor and a MBE or WBE. Failure by the Contractor to participate in any such arbitration is a material breach of the Construction Contract.

A MBE or WBE seeking arbitration shall serve written notice upon the contractor and file a demand for arbitration with the AAA in Chicago, IL. The dispute shall be arbitrated in accordance with the Commercial Arbitration Rules of the AAA. All arbitration fees are to be paid pro rata by the parties.

The MBE or WBE must copy the City on the Demand for Arbitration within 10 business days after filing with the AAA. The MBE or WBE must copy the City on the arbitrator's decision within 10 business days of receipt of the decision. Judgment upon the arbitrator's award may be entered in any court of competent jurisdiction.

XIII. Equal Employment Opportunity

Compliance with MBE and WBE requirements will not diminish or supplant equal employment opportunity and civil rights provisions as required by law related to bidder or contractor and subcontractor obligations.

MBE and WBE Special Conditions

Attachment A -Assist Agency List (Rev. Sept 2016)

Assist Agencies are comprised of not-for-profit agencies and/or chamber of commerce agencies that represent the interest of small, minority and/or women owned businesses.

*if
Prime Contractors should contact with subcontracting opportunities to connect certified firms.*

51st Street Business Association * 220 E. 51st Street Chicago, IL
60615 Phone 773-285-3401 Fax: 773-285-3407 Email:
the51ststreetbusinessassociation(5?vahoo com Web:
www.51stStreetChicago <http://www.51stStreetChicago> com
Maintains list of certified firms Yes Provides training for
businesses: Yes Association of Asian Construction Enterprises *
5677 W. Howard Niles, IL 60714 Phone: 847-673-7377 Fax: 847-
673-2358 Email: nakmancorD(5)aol com Maintains list of certified
firms- Yes Provides training for businesses: Yes

Austin African American Business Networking Assoc. 5820 W Chicago Ave., Chicago, IL 60651 Phone: 773-626-4497 Email: aaabna(S)vahoo com
Web' www.aaabna <http://www.aaabna> orq
Maintains list of certified firms. No

Provides training for businesses: Yes#**Black Contractors United**

12000 S. Marshfield Ave. Calumet Park, IL 60827 Phone: 708-

389-5730 Fax: 708-389-5735 Email:

valerie@blackcontractorsunited.com

<mailto:valerie@blackcontractorsunited.com>Web: www

blackcontractorsunited.com

<http://blackcontractorsunited.com>Maintains list of certified

firms: Yes Provides training for businesses: Yes

LGBT Chamber of Commerce of Illinois 3179 N Clark St., 2nd Floor Chicago, IL 60657 Phone. 773-303-0167 Fax 773-303-0168 Email- qrodriouez(5)

lqbtcc com Web: www labtcc.com <http://labtcc.com>

Maintains list of certified firms' Yes

Provides training for businesses: Yes#**Chatham Business Association Small Business Dev.** 800 E. 78th Street Chicago, IL 60619 Phone. 773-994-

5006 Fax- 773-855-8905 Email mehndakellv(5)cbaworks.org Web: www.cbaworks <http://www.cbaworks> orq

Maintains list of certified firms: Yes

Provides training for businesses Yes

Chicago Minority Supplier Development Council Inc. 105 W.

Adams, Suite 2300 Chicago, IL 60603-6233 Phone: 312-755-

2550 Fax. 312-755-8890 Email: Dbarreda(5)chicagoomsc.org

Web: www.chicagoomsc <http://www.chicagoomsc> orq

Maintains list of certified firms- Yes Provides training for

businesses Yes#**Chicago Urban League** 4510 S. Michigan Ave.

Chicago, IL 60653 Phone: 773-624-8810 Fax. 773-451-3579

Email: sbrinston(5)thechicagourbanleague orq Web. www.cul-

chicago.org <http://www.cul-chicago.org>Maintains list of

certified firms: Yes Provides training for businesses Yes

Chicago Women in Trades (CWIT) 2444 W 16th Street Chicago, IL 60608 Phone. 773-942-1444 Fax 312-942-1599 Email jvelhnaa(S)cwit2.org Web:

www.chicagowomenintrades2 orq Maintains list of certified firms No Provides training for businesses: Yes

#**Contractor Advisors Business**

Development Corp. 1507 E. 53rd Street, Suite 906 Chicago, IL 60615 Phone: 312^36-0301 Email: mfo(5)contractoradvisors us Web-

www.contractoradvisors <http://www.contractoradvisors> us

Maintains list of certified firms Yes

Provides training for businesses: Yes

MBE and WBE Special Conditions

Do For Self Community Development Co. * 7447 S South Shore **Far South Community Development Corporation** 9923 S.

Drive, Unit 22B Chicago, IL 60649 Phone- 773-356-7661 Email: Halsted Street, Suite D Chicago, IL 60628 Phone: 773-941-4833

dennisdoforsell(S)hotmail.com Web: www doforsell.org Maintains Fax- 773-941-5252 Email. lacv(5)farsouth.org Web:

list of certified firms: No Provides training for businesses Yes www.farsouthcdc.org <http://www.farsouthcdc.org>Maintains list

of certified firms: No Provides training for businesses: Yes

Federation of Women Contractors 216 W. Jackson Blvd. #625

Chicago, IL 60606 Phone: 312-360-1122 Fax. 312-750-1203

Email: fwcchicago@aol.com <mailto:fwcchicago@aol.com>Web.

www.fwcchicago.com <http://www.fwcchicago.com>Maintains list

of certified firms: Yes Provides training for businesses: Yes#

Greater Englewood Community Development Corp. 815 W.

63rd Street Chicago, IL 60621 Phone: 773-651-2400 Fax: 773-

651-2400 Email: iharbinOgreaterenglewoodcdc.org Web:

www.greaterenglewoodcdc <http://www.greaterenglewoodcdc>

orq Maintains list of certified firms: Yes Provides training for

businesses: Yes

Greater Pilsen Economic Development Assoc. 1801 S. Ashland Chicago, IL 60608 Phone 312-698-8898 Email greaterpilsen@gmail.com

<mailto:greaterpilsen@gmail.com>

Web: www.greaterpilsen.org

Maintains list of certified firms. Yes

Provides training for businesses. Yes#**Greater Far South**

Halsted Chamber of Commerce 10615 S. Halsted Street

Chicago, IL 60628 Phone: 518-556-1641 Fax: 773-941-4019

Email: halstedchamberevents(5)gmail.com Web:

www.greaterfarsouthhalstedchamber.org

<http://www.greaterfarsouthhalstedchamber.org>Maintains list of

certified firms: Yes Provides training for businesses: Yes

Hispanic American Construction Industry Association (HACIA)* 650 W Lake St., Unit 415 Chicago, IL 60661 Phone: 312-575-0389 Fax: 312-575-

0544 Email' jperrez@haciaworks.org Web: www.haciaworks.org Maintains list of certified firms Yes Provides training for businesses: Yes

#**Illinois**

Hispanic Chamber of Commerce 222 Merchandise Mart Plaza, Suite 1212 c/o 1871 Chicago, IL 60654 Phone. 312^125-9500 Email:

aalcantar@ihccbusiness.net Web: www.ihccbusiness <http://www.ihccbusiness> net
Maintains list of certified firms: Yes
Provides training for businesses: Yes

Illinois State Black Chamber of Commerce 411 Hamilton
Blvd., Suite 1404 Peoria, Illinois 61602 Phone 309-740-4430 /
773-294-8038 Fax 309-672-1379 Email: Larvivorv(3!
IllinoisBlackChamber.org / vqilb66709@vahoo.com
<mailto:vqilb66709@vahoo.com>www.illinoisblackchamberofcom
merce.org
<http://www.illinoisblackchamberofcommerce.org>Maintains list
of certified firms Yes Provides training for businesses Yes#**Latin
American Chamber of Commerce** 3512 W. Fullerton Avenue
Chicago, IL 60647 Phone: 773-252-5211 Fax: 773-252-7065
Email:ld.lorenzopadron@LACCUSA.com
<mailto:lorenzopadron@LACCUSA.com>Web:
www.LACCUSA.com <http://www.LACCUSA.com>Maintains list
of certified firms: Yes Provides training for businesses Yes

MBE and WBE Special Conditions

National Association of Women Business Owners 500 Davis Street, Ste 812 Evanston, IL 60201 Phone: 773-410-2484 Fax: 847-328-2018 Email:
wjaehn@nawbochicago.org <mailto:wjaehn@nawbochicago.org>
Web: www.nawbochicago.org
<http://www.nawbochicago.org>National Organization of Minority
Engineers (NOME) * 33 W. Monroe, Suite 1540 Chicago, IL
60603 Phone: 312-960-1239 Email: grandevents!@sbcglobal.net
Web: www.nomeonline.org <http://www.nomeonline.org>
Maintains list of certified firms' Yes Provides training for
businesses' Yes Maintains list of certified firms: Yes Provides training for
businesses: Yes
Rainbow/PUSH Coalition * 930 E. 50th Street Chicago, IL 60615 Phone' 773-256-2768 Fax: 773-373-4103 Email: jmitchell@rainbowpush.org Web:
www.rainbowpush <http://www.rainbowpush> org
Maintains list of certified firms Yes
Provides training for businesses No#**South Shore Chamber, Inc.** 1750 E. 71st Street, Suite 208 Chicago, IL 60649-2000 Phone: 773-955- 9508 Email:
twertz@southshorechamberinc.org <mailto:twertz@southshorechamberinc.org>
Web: www.southshorechamberinc.org <http://www.southshorechamberinc.org>
Maintains list of certified firms: Yes
Provides training for businesses: Yes

The Monroe Foundation 1547 South Wolf Road Hillside, Illinois 60162 Phone- 773-315-9720 Email- omonroe@themonroefoundation.org
<mailto:omonroe@themonroefoundation.org>
Web: www.themonroefoundation.org <http://www.themonroefoundation.org>

Maintains list of certified firms: No
Provides training for businesses Yes#**US Minority Contractors
Association, Inc.** 1250 Grove Ave. Suite 200 Barrington, IL
60010 Phone: 847-708-1597 Fax: 847-382-1787 Email:
admin@usminontvcontractors.org
<mailto:admin@usminontvcontractors.org>Web.
USMinorityContractors.org
<http://USMinorityContractors.org>Maintains list of certified firms:
Yes Provides training for businesses. Yes

Women's Business Development Center 8 S Michigan Ave , 4th Floor Chicago, IL 60603 Phone 312-853-3477 Fax: 312-853-0145 Email:
fcurrv@wbdc.org <mailto:fcurrv@wbdc.org>
Web- www.wbdc.org <http://www.wbdc.org>
Maintains list of certified firms Yes
Provides training for businesses- Yes#**Women Construction Owners & Executives (WCOE)** Chicago Caucus 308 Circle Avenue Forest Park, IL
60130 Phone: 708-366-1250 Email, mkmm@mkmservices.com <mailto:mkmm@mkmservices.com>
Web: www.wcoeusa.org
Maintains list of certified firms: Yes
Provides training for businesses: No

Your Community Consultants Foundation 9301 S. Parnell Ave., Chicago, IL 60620 Phone: 773-224-9299 Fax 773-371-0032 Email allen81354@aol.com Maintains list of certified firms: No Provides training for businesses- Yes

MBE and WBE Special Conditions

ARTICLE 7. INSURANCE REQUIREMENTS

CHICAGO SMART LIGHTING PROJECT

A. Insurance Coverage Required

The Contractors must provide and maintain at Contractors' own expense, during the term of the Agreement and during the time period following expiration if Contractors are required to return and perform any additional work, the insurance coverage and requirements specified below, insuring all operations related to the Agreement.

1) Workers Compensation and Employers Liability

Workers Compensation Insurance as prescribed by applicable law, covering all employees who are to perform work under this Agreement and Employers Liability coverage.

Statutory limits, with Coverage B - Employers Liability limits of:

Bodily Injury by Accident	\$1,000,000	Each Accident
Bodily Injury by Disease	\$1,000,000	Each Employee
Bodily Injury by Disease'	\$1,000,000	Policy Limit

2) Commercial General Liability Commercial General Liability Insurance must be maintained with limits of not less than \$1,000,000 per occurrence for bodily injury, personal injury and property damage liability. Coverages must include but not be limited to the following: all premises and operations, products/completed operations, separation of insureds, defense, and contractual liability (not to include Endorsement CG 21 39 or equivalent).

The City must be named as additional insureds under the policy. Such additional insured coverage shall be provided on a form acceptable to City. The additional insured coverage must not have any limiting endorsements or language under the policy such as but not limited to, Contractors' sole negligence or the additional insured's vicarious liability. Contractors' liability insurance shall be primary without right of contribution by any other insurance or self-insurance maintained by or available to the City.

3) Automobile Liability (Primary and Umbrella)

When any motor vehicles (owned, non-owned and hired) are used in connection with work to be performed, the Contractors must provide Automobile Liability Insurance with limits of not less than \$1,000,000 per occurrence for bodily injury and property damage. The City is to be named as an additional insured on a primary, non-contributory basis.

4) Excess/Umbrella Liability

Excess/Umbrella Liability Insurance must be maintained with limits of not less than \$5,000,000 million per occurrence and aggregate. The policy must provide the same coverages/follow form as the underlying Commercial General Liability, Automobile Liability, Employers Liability and Completed Operations coverage and expressly provide that the excess or umbrella policy will drop down over a reduced or exhausted aggregate limit of the underlying insurance.

5) Property Installation

When Contractors install, repair, replace, or maintain any of the equipment or network related to this Agreement, the Contractors must provide All Risk Property/Installation Insurance, at replacement cost, for loss or damage to

CSLP Insurance Requirements 113

equipment, machinery, materials or supplies that are part of the Agreement. Coverages must include in-transit, off-site, faulty workmanship or materials, testing and mechanical-electrical breakdown.

6) Tech Errors & Omissions (E&O)

When Contractors or any other professional consultants perform work in connection with this Agreement, Tech E&O Insurance covering acts, errors, or omissions must be maintained with limits of not less than \$5,000,000. Coverage must include but not limited to: performance of or failure to perform EDP and other computer services, failure of software product to perform the function for the purpose intended, dissemination and/or use of confidential information. When policies are renewed or replaced, the policy retroactive date must coincide with, or precede, start of work on the Agreement. A claim-made policy which is not renewed or replaced must have an extended reporting period of 2 years.

B. Additional Requirements

1. Evidence of Insurance. The Contractors must furnish the City, Procurement Department, 121 N. LaSalle, Rm 806, 60602, original certificates of insurance and endorsement(s), or such similar evidence, to be in force on the date of this Agreement, and renewal certificates of insurance and endorsement(s), or such similar evidence, if the coverages have an expiration or renewal date occurring during the term of this Agreement. The Contractors must submit evidence of insurance prior to Agreement award. The receipt of any certificate does not constitute agreement by the City that the insurance requirements in the Agreement have been fully met or that the insurance policies indicated on the certificate are in compliance with all Agreement requirements. The failure of the City to obtain certificates or other insurance evidence from Contractors showing compliance with the requirements of the Agreement is not a waiver by the City of any requirements for the Contractors to obtain and maintain the specified coverages. The Contractors must advise all insurers of the Agreement provisions regarding insurance. The City reserve the right to obtain complete, certified copies of any required insurance policies at any time.
2. Failure to Maintain Insurance. Non-conforming insurance does not relieve Contractors of the obligation to provide insurance as specified herein. Nonfulfillment of the insurance conditions may constitute a violation of the Agreement, and the City retain the right to stop work until proper evidence of insurance is provided, or the Agreement may be terminated.
3. Notice of Cancellation, Material Change or Violation. Contractors must provide for 60 days prior written notice to be given to the City in the event coverage is substantially changed, canceled, or non-renewed.
4. Insurance Requirements for subcontractors. Contractors must require all subcontractors to provide the insurance required herein, or Contractors may provide the coverage for subcontractors. All subcontractors are subject to the same insurance requirements of Contractors unless otherwise specified in this Agreement. Contractors are responsible for verifying each subcontractor complies with the required insurance provisions herein, and Contractors must ensure that the City is additional insured on insurance required from subcontractors.
5. Deductibles and Self-Insured Retentions. Any deductibles or self-insured retentions on referenced insurance coverages must be borne by Contractors.
6. Waiver of Subrogation. Contractors hereby grant to the City a waiver of any right of subrogation which any insurer of said Contractors may acquire against the City by virtue of the payment of any loss under such insurance. Contractors agree to obtain any endorsement that may be necessary to affect this waiver of subrogation, but this provision applies regardless of whether or not the City has received a waiver of subrogation endorsement from the insurer(s).
7. No Limitation as to Contractors' Liabilities. The Contractors expressly understand and agrees that any overages and limits furnished by Contractors in no way limit the Contractors' liabilities and responsibilities specified within the Agreement or by law.

1.

CSLP Insurance Requirements

8. No Contribution by City. Any insurance or self-insurance programs maintained by the City does not contribute with insurance provided by the Contractors under the Agreement.
 9. Insurance not limited by Indemnification. The required insurance to be carried is not limited by any limitations expressed in the indemnification language in this Agreement or any limitation placed on the indemnity in this Agreement given as a matter of law.
 10. Insurance limits maintained by Contractors. If Contractors maintain higher limits than the minimums required herein, the City requires and shall be entitled to coverage for the higher limits maintained by the Contractors. Any available insurance proceeds in excess of the specified minimum limits of insurance and coverage shall be available to the City.
 11. Joint Venture or Limited Liability Company Policies. If Contractors are a joint venture or limited liability company, the insurance policies must name the joint venture or limited liability company as a named insured.
 12. Other Insurance Obtained by Contractors. If Contractors or subcontractors desire additional coverages, the party desiring the additional coverages is responsible for the acquisition and cost.
 13. City and CIT Property and Contractor Property. Contractors are responsible for all loss or damage to City property at full replacement cost. Contractors are responsible for all loss or damage to personal property (including material, equipment, tools and supplies) owned, rented or used by Contractors.
 14. City's Right to Modify. Notwithstanding any provision in the Agreement to the contrary, the City's Risk Management Office maintains the right to modify, delete, alter or change these requirements.
- 8.

Name: Ameresco, Inc. Total Amount (Value): \$150 Million Fund

Chargeable: «click and type number»

SIGNED at Chicago, Illinois:

CONTRACTOR:

Ameresco, Inc.

By:

Name:

Its:

Attest: _____ :

State of _____ ; County of _____

This instrument was acknowledged before me on _____ (date) by _____ as President (or other authorized officer) and _____ as Secretary of _____ (name of party on behalf of whom instrument was executed).

Commission Expires

CITY OF CHICAGO

By:
CDOT Commissioner

Chief Information Officer

Budget Director

Execution page

EXHIBITS

Exhibits follow this page. Remainder of page intentionally blank.

EXHIBIT 1: SCOPE OF WORK

This Scope of Work is not intended to be an all-inclusive list of all work necessary to complete the Project, nor a contractual commitment to the ultimate scope that will be assigned through the Work Order and Task Order processes outlined in Sections 5.7-5.8. Contractor shall be responsible for completing the comprehensive Scope of Work, despite any specific references to various Subcontractors in Exhibits 1A-1C.

(A) LED Light Fixture Conversion

The conversion of existing outdoor lighting luminaires to LED "equivalents" will include the following scopes of work: (1)

Supply New LED Luminaires

Provide LED luminaires that best approximate the referenced standards outlined in Exhibit 1A - Lighting Specifications, subject to the City's approval throughout the term of this Agreement, for the installation of approximately 270,000 lighting fixtures (primarily cobra head).

Make available for purchase, by the City, additional LED luminaires and materials, as priced in Exhibit 2A and 2C. respectively for uses outside the scope of this Project.

(2) Removal, Salvage, Disposal, and Recycling of Existing Luminaires

Removal, salvage, disposal, and/or recycling of existing HPS or CMH luminaire fixtures to be replaced as part of the Project and any other discarded materials, in accordance with the scope of work and specifications in Exhibit 9.

Note: All luminaires removed by the Contractor to be scrapped will become the property of the Contractor and must be disposed of in full compliance with environmental regulations. Revenues from material recycling will accrue to the Contractor and should be used to offset Project costs.

10% of HPS luminaires removed by the Contractor will be delivered to a designated City facility for CDOT salvage for in-house repair inventory.

(3) New Luminaire and Lighting Control Hardware Installation

Installation of approximately 270,000 LED luminaires (primarily cobra head) as well as controller units (i.e., nodes), where applicable. All installations will be subject to the scope of work and specifications in Exhibit 9.

(4) Timely Documentation of LED Conversion Work

Provide record documentation of installed LED luminaires, GIS data, and similar information in a useable format that not only updates the current CDOT Lighting Inventory Database for utility bill synchronization but provides accurate work progress documentation that be used for scheduling and progress payments. Additionally, the Contractor will be responsible for verifying and documenting the circuit by which each fixture is controlled.

(B) Targeted Infrastructure Stabilization Repairs

The Targeted Infrastructure Stabilization Repairs Work will primarily consist of two efforts: (1)

Lighting Infrastructure Condition Assessment

Perform a visual lighting condition assessment of every light fixture listed in the CDOT lighting inventory database. The assessment must collect the lighting condition attribute data outlined in Exhibit 1C, and organize and integrate the

Scope of Work

collected data into a data base format that will be used to prioritize, assign, and track infrastructure repair work further described below in Section (B)(2).

(2) Infrastructure Stabilization Repairs

The scope of the repairs will be budget driven. The City will create a process that prioritizes the repairs that most cost effectively: (i) improves safety and, (ii) increases reliability. The focus will be on repairs that will have the greatest impact toward: (i) increasing light pole structural stability, (ii) reducing failure rates, and (iii) extending the useful life of existing lighting infrastructure.

Repair prioritization will focus on work that can be performed above ground (e.g. pole replacement and repairs as well as wiring repairs that will make temporary aerial wiring more permanent rather than replace with new underground conduit and wiring). All repairs will be subject to the scope of work and specifications in Exhibit 10.

(C) Lighting Management System

A more detailed scope of Work related to the delivery of the Lighting Management System (LMS, as defined in Exhibit IB) is described in Exhibit IB.

Generally, as part of the city-wide Lighting Management System Scope of Work, the Contractor will be responsible for the design, installation, start-up, commissioning, operation, and maintenance of a networked lighting management system that provides the following functionalities.

(1) LMS Core Functionality

At a minimum, the LMS Scope of Work will include the following:

Remote Monitoring and Control of Lighting

- Deploy and maintain networked lighting controls that:
- Enable remote programming of the LED fixtures - on, off, dimmed.
- Generate automatic outage alerts when a luminaire or lighting circuit requires repair or replacement.

Secure Timely Data Transmission

- Transmit data securely between (to and from) the lighting controllers (and other sensors, if applicable) and the LMS or other City systems in real-time or near real-time.

Lighting Asset Inventory

- Maintain an inventory of the City's lighting assets that includes, at a minimum:
 - o Lighting fixture unique product identifiers and its associated features, including type, model, and maximum power (watts); installation, maintenance, removal and disposal dates, and warranty information.
 - o **Lighting structure and its associated, circuitry, controller, power feed, lighting context, "lighting atlas" grouping and other data points collected in the Condition Assessment as outlined above in Section (B)(1) and detailed in Exhibit 1C.**

Energy Usage Data

- Provide accurate actual energy usage data.
- Note: Chicago's existing utility billing structure does not allow for billing based on the direct measurement of energy consumption, and as a result the City is not currently able to specify the energy measurement accuracy, precision, or data format requirements.

311 System Integration

Scope of Work

- Integrate the LMS with the City's 311 system to ensure that the current status of lights and related requests are available to residents.

Adaptive Lighting

- Enable optimization, through an adaptive lighting engineering process, of lighting levels and energy consumption for different areas of the city (i.e., arterial streets, residential streets, park paths, etc.) based on a variety of measured inputs and predicted events.

See Exhibit IB for more detailed LMS Scopes of Work.

- (2) LMS Optional Future Functionality. Future functionality may be added via Section 5.8 Task Order, including the following:

911 System Integration

- Integrate the LMS with the City's 911 system to facilitate the initiation of automatic event-based changes to lighting output.

Scope of Work

LIGHTING TECHNICAL AND PERFORMANCE SPECIFICATIONS

The City seeks to achieve the technical and performance specifications set forth in this Exhibit 1A, including the following:

- Electrical Specification No. 1600: Outdoor LED Luminaire Specifications: Residential Streets, Alleys, & Arterial Streets (Cobra Head)
- Electrical Specification No. 1602: Outdoor LED Luminaire Specifications: Residential Streets Ornamental (Acorn)
- Electrical Specification No. 1603: Outdoor LED Luminaire Specifications: Arterial Streets (Acorns)

- Electrical Specification No. 1604: Exhibit A-4: Outdoor LED Luminaire Specifications: Underpass and Viaduct
- Electrical Specification No. 1605: Outdoor LED Luminaire Specifications: Park Pathways (Cobra Head & Shoe Box Types)

These specifications do not provide for binding performance requirements; rather, they serve as reference documents for luminaire selection.

For Phase 1, Contractor has proposed to procure the Luminaires in Exhibit 1A, Attachment A, subject to the City's final selection and approval. Luminaires shall be required to perform in a manner that is consistent with the specification submittals in Exhibit 1A, Attachment A. The City reserves the right to reject luminaires that do not meet the attached specifications throughout the term of this Agreement.

For future Phases, Contractor must provide this Exhibit 1A, as it may be modified by the City in the City's discretion, to manufacturer(s) to determine which luminaires can best meet these specifications, all subject to the City's approval and selection, as set forth in Section 5.7.4.

Scope of Work

**ELECTRICAL SPECIFICATION No. 1600
CITY OF CHICAGO
DEPARTMENT OF TRANSPORTATION
DIVISION OF ENGINEERING
DECEMBER 9, 2016**

OUTDOOR LED LUMINAIRE SPECIFICATIONS:

RESIDENTIAL STREETS, ALLEYS, & ARTERIAL STREETS (Cobra Head)

SUBJECT

A. This specification states the requirements for non-ornamental Light Emitting Diode (LED) outdoor lighting luminaires. The specified LED luminaires will be used to replace existing High Pressure Sodium (HPS) and Ceramic Metal Halide (CMH) luminaires on Chicago residential streets, arterial streets, and alleys. The LED luminaires will be integrated into a centralized lighting management system.

GENERAL

A. References

American National Standards Institute (ANSI)

ANSI C78.377-2015, "American National Standard for Electric Lamps-Specifications for the Chromaticity of Solid State Lighting (SSL) Products"

ANSI C82.77-10-2014, "American National Standard for Lighting Equipment-Harmonic Emission Limits-Related Power Quality Requirements"

ANSI C136.2-2015, "American National Standard for Roadway and Area Lighting Equipment-Dielectric Withstand and Electrical Transient Immunity Requirements"

ANSI C136.10-2010, "American National Standard for Roadway and Area Lighting Equipment-Locking-Type Control Devices and Mating Receptacles-Physical and Electrical Interchangeability and Testing"

ANSI C136.15-2015, "American National Standard for Roadway and Area Lighting Equipment-Luminaire Field Identification"

ANSI C136.22-2004 (R2009, R2014), "American National Standard for Roadway and Area Lighting Equipment-Internal Labeling of Luminaires"

ANSI C136.25-2013, "American National Standard for Roadway and Area Lighting Equipment-Ingress Protection (Resistance to Dust, Solid Objects and Moisture) for Luminaire Enclosures"

ANSI C136.31-2015, "American National Standard for Roadway and Area Lighting Equipment-Pole Vibration"

ANSI C136.37-2011, "American National Standard for Solid State Light Sources Used in Roadway and Area Lighting"

ANSI C136.41-2013, "American National Standard for Roadway and Area Lighting Equipment-Dimming Control Between an External Locking Type Control and Ballast or Driver"

ASTM B85/B85M-14, "Standard Specification for Aluminum-Alloy Die Castings"

ASTM B117-16, "Standard Practice for Operating Salt Spray (Fog) Apparatus"

ASTM D523-14, "Standard Test Method for Specular Gloss"

ASTM D1654-08, "Standard Test Method for Evaluation of Painted or Coated Specimens Subjected to Corrosive 'Environments'"

ASTM G154-12a, "Standard Practice for Operating Fluorescent Ultraviolet (UV) Lamp Apparatus for Exposure of Nonmetallic Materials"

Illuminating Engineering Society of North America (IES) ANSI/IES LM-63-02,

"Standard File Format for Electronic Transfer of Photometric Data"

IES LM-79-08, "Approved Method: Electrical and Photometric Measurements of Solid-State Lighting Products"

Scope of Work

- ANSI/IES LM-80-15, "IES Approved Method: Measuring Luminous Flux and Color Maintenance of LED Packages, Arrays and Modules"
- ANSI/IES RP-8-14, "Roadway Lighting"
- IES TM-21-11 (with Addendum B), "Projecting Long Term Lumen Maintenance of LED Light Sources"

Institute of Electrical and Electronics Engineers (IEEE)

- IEEE Std 1789-2015, "IEEE Recommended Practices for Modulating Current in High-Brightness LEDs for Mitigating Health Risks to Viewers"

International Electrotechnical Commission (IEC)

- IEC 60929:2011 (with Amendment 1), "AC and/or DC-supplied electronic control gear for tubular fluorescent lamps - Performance requirements"

Underwriters Laboratories (UL)

- ANSI/UL 1598 (3rd Edition), "Luminaires"

Scope of Work

B. Submittal Requirements:

The Contractor must submit the following information pertaining to each specified luminaire type within fifteen (15) days of request:

1. Completed ATTACHMENT G - Submittal Form
2. Product Data Sheets.
 - a) Luminaire data sheets - including summary product description, dimensioned outline drawings, and nominal characteristics including but not limited to: initial luminous flux (lumens), input power (watts), input voltage range (volts), LED drive current (milliamps), correlated color temperature (kelvins), color rendering index, effective projected area (square feet) and weight (pounds).
 - b) LED Driver data sheet - including information described in LED Driver Requirements Section III-I-3.
 - c) LED light source data sheet
 - d) Surge protection device data sheet - if applicable

3. Photometric Performance Data

The manufacturer must provide photometric calculations, as part of each luminaire's submittal package, that demonstrate the luminaire's photometric performance will meet or exceed the photometric requirements listed in this specification. The submitted lighting calculations must include point-by-point illuminance, luminance and veiling luminance data, as well as listings of all indicated averages and ratios. Photometric reports must include the following information and be in accordance with the standards listed below:

- a) IES LM-79-08 photometric report that includes measured values for initial luminous flux, input power, correlated color temperature, and color rendering index.
- b) ANSI/IES LM-63-02 electronic format photometric file that corresponds to the LM-79 report.
- c) LM-63 photometric calculations that demonstrate compliance with the illumination requirements specified herein using the LM-63 file. Calculation grids and observer locations not specified herein must be in accordance with ANSI/IES RP-8-14.
- d) IES TM-21-11 calculations that derive the lumen maintenance (lamp lumen depreciation or LLD) factor applied to photometric calculations specified herein.
 - ANSI/IES LM-80-15 and in-situ temperature measurement testing (ISTMT) reports containing data used in TM-21 calculations must also be submitted.
 - TM-21 calculations must apply to the maximum LED case temperature from ISTMT, shall not extrapolate beyond six times the duration of available LM-80 test data, and must be submitted in the spreadsheet format of the ENERGY STAR TM-21 calculator (<https://www.energystar.gov/products/spec/luminaires> <<http://www.energystar.gov/products/spec/luminaires>> specification version 2.0 pd).

LM-79, ISTMT, and LM-80 reports must correspond directly to submitted luminaires, and must be produced by test laboratories that satisfy the Testing Laboratory Requirements of the DesignLights Consortium (www.designlights.org/content/QPL/ProductSubmit/LabTesting).

ISTMT must be conducted in accordance with the DesignLights Consortium Manufacturer's Guide (<https://www.designlights.org/content/qpl/productssubmit> <<http://www.designlights.org/content/qpl/productssubmit>>).

Scope of Work

ISTMT shall be conducted in an ambient temperature of 25 ± 5 °C. Ambient temperature variations above or below 25 °C shall be respectively subtracted from or added to temperatures recorded at points on the luminaire.

4. Safety Certification - file number indicating compliance with UL 1598. Applicable testing bodies are determined by the US Occupational Safety Health Administration (OSHA) as Nationally Recognized Testing Laboratories (NRTL) and include: CSA (Canadian Standards Association), ETL (Edison Testing Laboratory), and UL (Underwriters Laboratory).

5. Vibration Testing - the luminaire must comply with ANSI C136.31 at Vibration Test Level 2 (3.0 G).

6. Product Samples - at least two samples of each luminaire that the contractor proposes to use must be submitted to the City. All samples must be representative production units and be supplied at no cost to the City.

C. Assembly.

Each luminaire must be delivered completely assembled, wired, and ready for installation.

D. Warranty.

The luminaire manufacturer must warrant the performance and construction of luminaires to meet the requirements of this specification, and must warrant all parts, components and appurtenances against defects due to design, workmanship or material developing within a period of ten (10) years from the date of acceptance by the City.

- The inability of a luminaire to be dimmed will constitute a luminaire failure.
- Failure of 10% or more of the LED light sources (packages or arrays/modules) in a luminaire will constitute a luminaire failure.

- The warranty must apply for application on all of the City's existing electrical systems, both grounded and ungrounded.
- During the warranty period the City may, from time to time, test a random sampling of 10-20 luminaires for verification of light output per IES LM-79 and to test dimming functionality for a given luminaire population. The percentage of luminaires not performing as required in the random sampling will be applied to the total population quantity to determine the number of new luminaire replacements that must be delivered to the City by the manufacturer, without expense to the City.

E. Manufacturing Experience and Capacity

The manufacturer must demonstrate at least a five year history of manufacturing LED roadway and outside area luminaires by providing a list of prior projects with project description, date, location, quantities and reference contact information. The manufacturer must also demonstrate the capacity to supply the quantities required for the contract in a timely manner.

Scope of Work

CONSTRUCTION

A. Weight

B. The net weight of these luminaires must not be more than 30 pounds.

C. Housing^

D. The preferred luminaire housing material is die-cast aluminum alloy meeting ASTM Specification A380. Alternate materials may be considered. The housing must enclose the mounting hardware, LED arrays, control receptacle, terminal board, and electronic driver. The housing must include a surface to facilitate leveling with a spirit level. The housing must have integral heat sink characteristics, such that all enclosed components will operate within their designed operating temperatures under expected service conditions. No external or removable heat shields or heat sinks; are permitted. The housing must be designed to encourage water shedding. The housing must be designed to minimize dirt and bug accumulation on the optic surface.

E. Mounting Provisions.

F. The luminaire must include a heavy gauge slip fitter clamping assembly suitable for secure attachment over the end of a two (2) inch 2" IP (2.375" OD) steel pipe with an approved means of clamping it firmly in mounting bracket. The slip fitter mounting clamp must contain an approved shield around the pipe entrance to block the entry of birds.

G. Access Door-Panel.

H. An access door panel allowing access to the terminal strip and LED driver must be provided. A die-cast aluminum door-panel composed of aluminum alloy A380 is preferred; alternate materials may be considered. The door-panel must be hinged to the luminaire housing and suitably latched and fastened at the closing end. It must be made to be removed easily. Th hinge and fastening devices must be captive parts which will not

become disengaged from the door panel.

I. Hardware.

J. All machine screws, locknuts, pins and set screws necessary to make a firm assembly, and for its secure attachment to the mast arm, must be furnished in place. All hardware must be of stainless steel, zinc plated steel, copper silicon alloy or other non-corrosive metal, and where necessary must be suitably plated to prevent electrolytic action by contact with dissimilar metals.

K. Finish.

L. The luminaire must have a polyester powder coat with a minimum 2.0 mil thickness. Surface texture and paint quality will be subject to approval. Color must be as specified in the order. A paint chip must be submitted as a sample upon request. The finish must exceed a rating of six per ASTM D1654 after 1000 hours of testing per ASTM B117. The coating must exhibit no greater than 30% reduction of gloss per ASTM D523 after 500 hours of QUV testing at ASTM G154 Cycle 6.

M. Ingress Protection.

1. The luminaire electric compartment housing must have an ingress protection rating of IP54 or better as described in ANSI C136.25-2013). The optical system must have a minimum rating of IP 66.

2. The luminaire must be listed for wet locations by a U.S. Occupational Safety Health Administration (OSHA) Nationally Recognized Laboratory (NRTL) and have a safety certification and file number indicating compliance with UL 1598.

N. General Luminaire Requirements

1. The luminaire must be rated to operate between -40° to +50° Celsius.

Scope of Work

2. The luminaire must have the option of adding a house side shield. The shield should be designed to be easily installed in the field. The house side shield must be composed of a sturdy material capable of withstanding vibrations and weather conditions. The shield must cut off light trespass at approximately one mounting height behind the pole.

3. The luminaire must meet the requirements of ANSI C136.22 for internal labeling. A bar code with pertinent information for warranty and maintenance must be attached to the inside of the housing. A separate bar code label must be on the driver

4. The luminaire must be able to provide pertinent product information, for warranty and maintenance purposes, in a digital format that is compliant with the Digital Addressable Lighting Interface (DALI) protocol. This information will be transmitted through the networked Lighting Management control system.

O. Electrical Components

1. LED Optical Arrays

a) The LED arrays must be properly secured at the factory and must not require field adjustment for optimum photometric performance.

2. Terminal Block

a) A terminal block of high grade molded plastic of the barrier or safety type must be mounted within the housing in a readily accessible location.

b) Terminal block wiring; all necessary terminals, pre-wired to all luminaire components, must be provided.

c) Terminal block terminals must have copper plated or brass plated, clamp-type pressure connectors of an approved type for "line" connections, to accommodate wire sizes from #12 to #8 A.W.G.

d) Terminal block terminals for internal component connections must be either the screw-clamp or quick disconnect type.

3. LED Driver:
- a) Voltage. The electronic driver must operate at an input voltage range of between 120 and 277 volts, 60 Hertz. It must automatically sense the input voltage and adjust the output accordingly. The City uses nominal input voltages of 120, 208, and 240 for street lighting. When operated at any supply voltage between 80 percent and 110 percent of its rated supply voltage and at rated input frequency, a driver shall provide current and/or voltage regulation that equals or exceeds the values specified by the manufacturer.
 - b) Electrical Safety. Luminaires must operate at or below the Low-Risk Level, as defined in Figure 18 of IEEE 1789-2015. This requirement must be satisfied across the dimming range.
 - c) Power Factor (PF). The power factor of the driver over the design range of input voltages specified above must be in accordance to ANSI C82.77-2014. PF must be > 0.9.
 - d) Total Harmonic Distortion (THD). The driver input current must have specified THD in accordance to ANSI C82.77-2014. THD must be <32%.
 - e) Thermal Protection. The driver must be thermally protected to shut off when operating temperatures reach unacceptable levels.
 - f)
 - g) Electromagnetic Interference. Luminaire must comply with the FCC radiation emission limits for Class B digital devices given at 47 CFR 15.109.

Scope of Work

Electrical Transient Immunity.

- Dielectric Withstand Testing - luminaire must meet the performance requirements specified in ANSI C136.2-2015 for dielectric withstand, using the DC test level and configuration.
- Electrical Transient Immunity - luminaire must meet the performance requirements specified in ANSI C136.2-2015 for electrical transient immunity, using the Enhanced (10 kV / 5 kA) combination wave test level.
- Transient Immunity Testing Requirements
 - During electrical transient immunity testing, the device under test (DUT) must: be connected to the power source through a series coupler/decoupler network (CDN), using a two-wire (hot or hot/neutral) connection between both the power supply and CDN input and the CDN output and DUT.
 - If AC mains is used to power the DUT, the input waveform must be characterized and documented both before and after electrical transient immunity testing, with the DUT operating at rated full output.
 - For Pre-Test DUT Characterization, the diagnostic measurements shall, at a minimum, include the following: real power, input current (RMS; Root-Means-Square), power factor, and current distortion factor (THD-I Total Harmonic Distortion) when operating at rated full output.
 - Manufacturer must indicate on submittal form whether failure of the electrical transient immunity system can possibly result in disconnect of power to luminaire.

i) Dimming Capability. The driver must be capable of dimming. The dimming range must be 10% to 100% of full output. The digital lighting interface used for dimming must be DALI (Digital Addressable Lighting Interface) as per the requirements of IEC 62386. There must be a minimum of 100 dimming steps between the top and bottom of the dimming range.

4. Wiring.

- a) All components must be completely factory wired with non-fading, color coded leads. These leads must be insulated with an approved class of insulation and must be #16 AWG conductor at a minimum.
- b) All wires within a single circuit path must be of the same size.
- c) No wire-nut splicing will be allowed.
- d) No unnecessary splices will be allowed.
- e) Quick disconnects must be provided for all components.
- f) All wires must be properly terminated.

5. Control Device Receptacle and Cap.

- a) Twist-lock Receptacle for a control device that meets ANSI C136.41 must be mounted in the top of the housing with provision for proper positioning of the control device.
- b) 7-pin Receptacle. The luminaire control receptacle must be fully prewired and compliant with ANSI C136.41.
- c) 3-prong Shorting Cap that meets ANSI C136.10 must be provided.
- d) Receptacle Wire Leads must all be properly terminated.
- e) Receptacle repositioning. The receptacle must be able to be repositioned without the use of tools.
- f) Control Devices Not Included in LED Specifications. Whereas specifications for control receptacles are included, specifications for control devices are not. The control device performance requirements are part of the lighting management system specifications in the Smart Lighting Project Technology specifications.

6. Component Mounting.

All electrical components must be securely mounted in such manner that individual components can be easily maintained or replaced. Permanent straps or tie-wraps will not be permitted. The entire assembly should be easily disconnected and removed for replacement.

Scope of Work

■ < I, M:

IV. PHOTOMETRIC REQUIREMENTS

1. Light Pollution.

2. To limit light pollution, the submitted luminaires must not emit any light above the horizon (0 lumens at angles > 90° from luminaire nadir).

3. Lumen Maintenance.

- a) LED arrays must deliver a minimum of 90% of initial lumen output at 36,000 hours of operation.
- b) Light Loss Factor (LLF) < 1.0. Calculations for maintained values, i.e. $LLF = LLD \times LDD \times LAT$.
 - (1) Lamp Lumen Depreciation (LLD) calculated at 60,000 hours as per Section II-B-3-d above,
 - (2) Luminaire Dirt Depreciation (LDD) < 0.90, and
 - (3) Luminaire Ambient Temperature (LAT) < 0.96

Luminaires with less than 10,000 hours of available LM-80 test data may be submitted for consideration but must be clearly indicated as such.

- c) Color Attributes
- d) Color Rendering Index (CRI) shall be no less than 65.
- e) Nominal Correlated Color Temperature (CCT) shall be 3000K as defined by ANSI C78.377 and described below:

Manufacturer-Rated Nominal CCT (K)	Allowable IES LM-79 CRI Attributes	Measured Duv
3000	2870 to 3220	-0.006 to 0.006

4. City of Chicago Typical Lighting Contexts

ATTACHMENT A (below) lists the photometric performance requirements for luminaires used in the following typical municipal outdoor lighting applications:

- Alleys.
- Modern Residential Streets - staggered poles on both sides.
- Legacy Residential Streets - one-sided pole spacing.
- Legacy Residential Intersections and Alley Entrances.
- Arterial Streets-two-sided opposite pole spacing >
- Arterial Streets-two-sided staggered pole spacing
- Arterial Streets - one-side pole spacing

See ATTACHMENTS B, C, & C-I for residential street layouts.

Note: The layout for (i) the intersection of two Legacy Residential Streets, (ii) an alley entrance intersecting with a Legacy Residential Street, and (in) a typical alley layout is found in ATTACHMENT C-I. Luminaires for both alley entrance lighting and intersection lighting are oriented 45° from the curb line. All other luminaires are oriented 90° from (i.e., perpendicular to) the curb line. See ATTACHMENTS D, E, & F for arterial layouts.

Scope of Work 130

ATTACHMENT A - Photometric Performance Requirements

STREET PARAMETERS

TYPICAL LIGHTING RESIDENTIAL*	RESIDENTIAL		ALLEY	ARTERIAL			
POLE CONFIGURATION	STAGGERED	ONESIDED	INT R-R and R-A	ONE-SIDED	OPPOSITE	STAGGERED	ONESIDED
RIGHT OF WAY (ft)	66 ft.	66 ft.	66 ft.	16 ft.	100 ft.	80 ft.	66 ft.
STREET PAVEMENT	CR3	R3	R3	R3	R3	R3	R3
STREET WIDTH (ft)	34 ft.	34 ft.	34 ft.	16 ft.	80 ft.	60 ft.	48 ft.
LANES (Incl Parking)	4	4	4	2	7	6	4
PARKWAY (Width) (ft)	10 ft.	10 ft.	10 ft.	N/A	4 ft.	4'	N/A
SIDEWALK (Width) (ft)	6 ft.	6 ft.	6 ft.	N/A	6 ft.	6 ft.	9 ft.
HEIGHT TO LUMINAIRE (ft)	8 ft.	22 ft.	22 ft.	18 ft.	33 ft.	33 ft.	33 ft.
MAST ARM LENGTH (ft)	8 ft.	15 ft.	15 ft.	1ft.	12 ft.	12 ft.	8 ft.
POLE SETBACK (ft) (Center of Pole)	13 ft.	2 ft.	2 ft.	N/A	3 ft.	3 ft.	3 ft.

IN-LINE POLE SPACING/See Site Plan Attachments B thru F for pole spacing assumptions for each Pole Configuration context

MAINTAINED PERFORMANCE REQUIREMENTS

LUMINAIRE REQUIREMENTS	STAGGERED	ONESIDED	INT R-R and R-A	ONE-SIDED	OPPOSITE	STAGGERED	ONESIDED
Max Input Power - 120 Luminescence (Watts)	130	130	130	80	180	180	180
Default/Normal Average Illuminance (cd/m ²)	>1.5	>1.5	>1.5	>95	>1.7	>1.7	>1.7
AVG/MIN Uniformity	<6:1	<6:1	<6:1	<6:1	<3:1	<3:1	<3:1
MAX/MIN Uniformity	<10:1	<10:1	<10:1	<10:1	<5:1	<5:1	<5:1

Scope of Work

MAX Veiling Luminance Ratio	<0.4	<0.4	<0.4	<0.4	<0.3	<0.3	<0.3
-----------------------------	------	------	------	------	------	------	------

AVG. Boosted Luminance (cd/m ²)	>2.25	>2.25	>2.25	>1.5	>2.5	>2.5	>2.5
[Add-Alternate] SIDEWALK							
Default AVG. Horizontal Illuminance (fc)	>0.50	>0.50	>0.50	N/A	>0.50	>0.50	>0.50
AVG.MIN Uniformity Ratio (Horizontal Illuminance)	<4:1	<4:1	<4:1	N/A	<4:1	<4:1	<4:1
LIGHT TRESPASS RESTRICTIONS as measured in a vertical plane 10' beyond ROW <3' height							
-							
MAX Vertical Illuminance	<0.07	<0.30	<0.30	<0.05	<0.3	<0.30	<0.30

*Residential Pole Configuration Contexts: See Attachments B, C, & C-I Staggered = Residential street with Modern poles; (aluminum davit poles staggered) = intersection of two Legacy residential streets, illuminated by one luminaire oriented diagonally (45°), Attachment C-I. INT R-A = intersection of Legacy residential streets with Legacy poles

Scope of Work

ATTACHMENT B - Residential Modern Street (Staggered) & Alley

Scope of Work

ATTACHMENT C - Residential Legacy Street (One-sided) & Alley

Scope of Work

ATTACHMENT C-I-Intersections-Legacy Residential Streets & Alley

DRIVE
LJ

-1 ALLEY
R.&rvr- ■

DRIVE

ALLEY

I
OR I WE

34

10-

«J

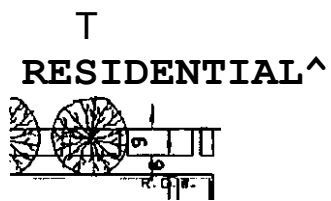

10

Q CO

DRIVE

& ALLEY

DRIVE

ATTACHMENT D - Arterial Street Single-Sided Poles

Scope of Work

ATTACHMENT E - Arterial Street - Staggered Poles

Scope of Work

ATTACHMENT F - Arterial Street Opposite Poles

Scope of Work

ATTACHMENT G - Product Submittal Form

<i>Lighting Context</i>	<i>e.g. Alleys</i>	
<i>Product Information Description</i>	<i>Product Data / * (Summary)</i>	<i>Submittal Q^o fee \$ pce-: ■ Document</i>
Luminaire Designation		
Luminaire Manufacturer		
Luminaire Model Number		
Luminous Flux - initial	lumens	
Luminaire input power-initial	watts	
Luminaire input power-maintained	watts	
Luminaire input voltage- nominal range	volts	
LED drive current - initial	milliamps	
LED drive current - maintained	milliamps	
CCT (correlated color temperature)	kelvin	
CRI (color rendering index)		
EPA (effective projected area) - nominal	sq. ft.	
Luminaire Weight - nominal	lbs.	
Control Interface	<input type="checkbox"/> ANSI C136.41, 7-pin	
LED Driver - dimming capability	<input type="checkbox"/> Dimmable, 0-10V <input type="checkbox"/> Dimmable, DALI	
LED driver- rated life	years	
Electrical transient immunity ANSI C136.2 combination wave test level	<input type="checkbox"/> Basic (6kV/3kA) <input type="checkbox"/> Enhanced (10kV/5kA) <input type="checkbox"/> Elevated (20kV/10kA)	
Vibration Test-ANSI C136.31	<input type="checkbox"/> Level 2	
Luminaire warranty period	years	
IES LM-80 test duration	hours	IES LM-80-15 repo

Scope of Work

LED lumen maintenance at 36,000 hours	%	TM-21 calculator
Max. LED case temperature	degrees Celsius	ISTMT report

Scope of Work

ELECTRICAL SPECIFICATION No. 1602
CITY OF CHICAGO DEPARTMENT OF
TRANSPORTATION DIVISION OF
ENGINEERING DECEMBER 9, 2016

OUTDOOR _____ LED _____ LUMINAIRE _____ SPECIFICATIONS:

RESIDENTIAL STREETS ORNAMENTAL (Acorn)

I. SUBJECT

- A. This specification states the requirements for non-ornamental Light Emitting Diode (LED) outdoor lighting luminaires. The specified LED luminaires will be used to replace existing High Pressure Sodium (HPS) and Ceramic Metal Halide (CMH) luminaires on Chicago residential streets, arterial streets, and alleys. The LED luminaires will be integrated into a centralized lighting management system.

II. GENERAL

A. References

American National Standards Institute (ANSI)

- ANSI C78.377-2015, "American National Standard for Electric Lamps-Specifications for the Chromaticity of Solid State Lighting (SSL) Products"
- ANSI C82.77-10-2014, "American National Standard for Lighting Equipment-Harmonic Emission Limits-Related Power Quality Requirements"
- ANSI C136.2-2015, "American National Standard for Roadway and Area Lighting Equipment-Dielectric Withstand and Electrical Transient Immunity Requirements"
- ANSI C136.10-2010, "American National Standard for Roadway and Area Lighting Equipment -Locking-Type Control Devices and Mating Receptacles-Physical and Electrical Interchangeability and Testing"
- ANSI C136.15-2015, "American National Standard for Roadway and Area Lighting Equipment-Luminaire Field Identification"
- ANSI C136.22-2004 (R2009, R2014), "American National Standard for Roadway and Area Lighting Equipment-Internal Labeling of Luminaires"
- ANSI C136.25-2013, "American National Standard for Roadway and Area Lighting Equipment-Ingress Protection (Resistance to Dust, Solid Objects and Moisture) for Luminaire Enclosures"
- ANSI C136.31-2015, "American National Standard for Roadway and Area Lighting Equipment-Pole Vibration"
- ANSI C136.37-2011, "American National Standard for Solid State Light Sources Used in Roadway and Area Lighting"
- ANSI C136.41-2013, "American National Standard for Roadway and Area Lighting Equipment-Dimming Control Between an External Locking Type Control and Ballast or Driver"
- ASTM B85/B85M-14, "Standard Specification for Aluminum-Alloy Die Castings"
- ASTM B117-16, "Standard Practice for Operating Salt Spray (Fog) Apparatus"
- ASTM D523-14, "Standard Test Method for Specular Gloss"
- ASTM D1654-08, "Standard Test Method for Evaluation of Painted or Coated Specimens Subjected to Corrosive Environments"
- ASTM G154-12a, "Standard Practice for Operating Fluorescent Ultraviolet (UV) Lamp Apparatus for Exposure of Nonmetallic Materials"

Illuminating Engineering Society of North America (IES)

- ANSI/IES LM-63-02, "Standard File Format for Electronic Transfer of Photometric Data"

Scope of Work

- IES LM-79-08, "Approved Method: Electrical and Photometric Measurements of Solid-State Lighting Products"
- ANSI/IES LM-80-15, "IES Approved Method: Measuring Luminous Flux and Color Maintenance of LED Packages, Arrays and Modules"
- ANSI/IES RP-8-14, "Roadway Lighting"
- IES TM-21-11 (with Addendum B), "Projecting Long Term Lumen Maintenance of LED Light Sources"

Institute of Electrical and Electronics Engineers (IEEE)

- IEEE Std 1789-2015, "IEEE Recommended Practices for Modulating Current in High-Brightness LEDs for Mitigating Health Risks to Viewers"

International Electrotechnical Commission (IEC)

- IEC 60929:2011 (with Amendment 1), "AC and/or DC-supplied electronic control gear for tubular fluorescent lamps - Performance requirements"

Underwriters Laboratories (UL)

- ANSI/UL 1598 (3rd Edition), "Luminaires"

Scope of Work

B. Submittal Requirements:

The Contractor must submit the following information pertaining to each specified luminaire type within fifteen (15) days of request:

1. Completed ATTACHMENT G - Submittal Form
2. Product Data Sheets.
 - a. Luminaire data sheets - including summary product description, dimensioned outline drawings, and nominal characteristics including but not limited to: initial luminous flux (lumens), input power (watts), input voltage range (volts), LED drive current (milliamps), correlated color temperature (kelvins), color rendering index, effective projected area (square feet) and weight (pounds).
 - b. LED Driver data sheet - including information described in LED Driver Requirements Section III-I-3.
 - c. LED light source data sheet
 - d. Surge protection device data sheet - if applicable
3. Photometric Performance Data

The manufacturer must provide photometric calculations, as part of each luminaire's submittal package, that demonstrate the luminaire's photometric performance will meet or exceed the photometric requirements listed in this specification. The submitted lighting calculations must include point-by-point illuminance, luminance and veiling luminance data, as well as listings of all indicated averages and ratios. Photometric reports must include the following information and be in accordance with the standards listed below:

 - a. IES LM-79-08 photometric report that includes measured values for initial luminous flux, input power, correlated color temperature, and color rendering index.
 - b. ANSI/IES LM-63-02 electronic format photometric file that corresponds to the LM-79 report.

- c. LM-63 photometric calculations that demonstrate compliance with the illumination requirements specified herein using the LM-63 file. Calculation grids and observer locations not specified herein must be in accordance with ANSI/IES RP-8-14.
- d. IES TM-21-11 calculations that derive the lumen maintenance (lamp lumen depreciation or LLD) factor applied to photometric calculations specified herein.
 - ANSI/IES LM-80-15 and in-situ temperature measurement testing (ISTMT) reports containing data used in TM-21 calculations must also be submitted. TM-21 calculations must apply to the maximum LED case temperature from ISTMT, shall not extrapolate beyond six times the duration of available LM-80 test data, and must be submitted in the spreadsheet format of the ENERGY STAR TM-21 calculator (<https://www.energystar.gov/products/spec/luminaires> <<http://www.energystar.gov/products/spec/luminaires>> specification version 2.0 pd).

LM-79, ISTMT, and LM-80 reports must correspond directly to submitted luminaires, and must be produced by test laboratories that satisfy the Testing Laboratory Requirements of the DesignLights Consortium (www.designlights.org/content/QPL/ProductSubmit/LabTesting <<http://www.designlights.org/content/QPL/ProductSubmit/LabTesting>>). ISTMT must be conducted in accordance with the DesignLights Consortium Manufacturer's Guide (<https://www.designlights.org/content/qpl/productssubmit> <<http://www.designlights.org/content/qpl/productssubmit>>).

ISTMT shall be conducted in an ambient temperature of 25 ± 5 °C. Ambient temperature variations above or below 25 °C shall be respectively subtracted from or added to temperatures recorded at points on the luminaire.

Scope of Work

4. Safety Certification - file number indicating compliance with UL 1598. Applicable testing bodies are determined by the US Occupational Safety Health Administration (OSHA) as Nationally Recognized Testing Laboratories (NRTL) and include: CSA (Canadian Standards Association), ETL (Edison Testing Laboratory), and UL (Underwriters Laboratory).
5. Vibration Testing - the luminaire must comply with ANSI C136.31 at Vibration Test Level 2 (3.0 G).
6. Product Samples - at least two samples of each luminaire that the contractor proposes to use must be submitted to the City. All samples must be representative production units and be supplied at no cost to the City.

C. Assembly.

Each luminaire must be delivered completely assembled, wired, and ready for installation.

D. Warranty.

The luminaire manufacturer must warrant the performance and construction of luminaires to meet the requirements of this specification, and must warrant all parts, components and appurtenances against defects due to design, workmanship or material developing within a period of ten (10) years from the date of acceptance by the City.

- The inability of a luminaire to be dimmed will constitute a luminaire failure.
- Failure of 10% or more of the LED light sources (packages or arrays/modules) in a luminaire will constitute a luminaire failure.
- The warranty must apply for application on all of the City's existing electrical systems, both grounded and ungrounded.
- During the warranty period the City may, from time to time, test a random sampling of 10-20 luminaires for verification of light output per IES LM-79 and to test dimming functionality for a given luminaire population. The percentage of luminaires not performing as required in the random sampling will be applied to the total population quantity to determine the number of new luminaire replacements that must be delivered to the City by the manufacturer, without expense to the City.

E. Manufacturing Experience and Capacity

The manufacturer must demonstrate at least a five year history of manufacturing LED roadway and outside area luminaires by providing a list of prior projects with project description, date, location, quantities and reference contact information. The manufacturer must also demonstrate the capacity to supply the quantities required for the contract in a timely manner.

III. CONSTRUCTION.

A. CAPITAL

- (a) **Material.** Each capital shall be die-cast aluminum conforming to ASTM B85, Grade 360. The top of the luminaire globe shall be spun aluminum, .090 inches thick. The finial shall be cast aluminum conforming to ASTM B26, grade 319.
- (b) **Appearance.** The capital shall conform in appearance to that shown on Electrical Standard Drawing Number 958.
- (c) **Construction.** Castings must have smooth external surfaces free from protuberances, dents, cracks or other imperfections marring their appearance. Welding or plugging of casting defects is prohibited.
- (d) **Structural Integrity.** The capital shall fit over a 3" high by 3" O.D. tenon. The attachment to the bracket must provide the structural integrity to hold the luminaire firmly in place during the vibrations anticipated due to passing heavily

(a) *Scope of Work*

loaded vehicles, wind loading, and inclement weather. A minimum of 3/16" thickness of metal must be provided where the set screws are inserted to minimize the possibility of stripping the threads when the set screws are tightened into place. The set screws must be 5/16-18 stainless steel hex head screws. A minimum of three (3) set screws must be provided, evenly spaced at 120° apart. All machine screws, locknuts, pins and set screws necessary to make a firm assembly, and for its secure attachment to the mast arm, must be furnished in place. All hardware must be of stainless steel, zinc plated steel, copper silicon alloy or other non-corrosive metal, and where necessary must be suitably plated to prevent electrolytic action by contact with dissimilar metals.

B. PAINTING

- (a) **Surface Preparation.** Exterior surfaces of the capital shall be prepared by "Solvent Cleaning" per SSPC-SP1 using a solvent recommended for aluminum surfaces. Solvent must be used as per written instructions of the manufacturer to remove all oil, grease, dirt and contaminants.
- (b) **Primer Type.** Within one hour of surface preparation, surfaces must be primed using a primer specifically recommended for aluminum surfaces.
- (c) **Primer Application.** Primer shall be applied in accordance with written instructions of the manufacturer to produce a minimum dry thickness film of 3.0 mils. Primer must dry for a minimum of 30 minutes and a maximum of 60 minutes before application of finish coat.
- (d) **Finish Coat.** Finish coat shall be a polyurethane enamel specifically recommended for use over a primed aluminum surface. Two (2) coats of finish must be applied. Each coat must be a minimum of 1.5 mils dry thickness.
- (e) **Durability.** The paint must be capable of passing 1000 hours of salt spray as per ASTM B117.
- (f) **Color** will be silver or anodized, as specified on the order. Color samples will be approved by the Commissioner.
- (g) **Alternate painting methods** will be considered where the contractor can demonstrate to the satisfaction of the Commissioner that these methods have been in successful use for a five (5) year minimum period.

C. COMPONENT MOUNTING

- (a) **Modular Construction.** All electrical components shall be securely mounted to the capital by means of easily removable stainless steel captive thumb screws or by easily operated stainless steel latches. The luminaire shall be designed to allow easy access to quick disconnects, terminal blocks and components for installation and maintenance.

- (b) Quick Disconnect. Wiring from the terminal block to the components must utilize a three (3) conductor, phenolic, polarized, quick disconnect device.
- (c) Interchangeability. The driver must be mutually field interchangeable so that units can be restored to working condition without trouble shooting components.

D. ACORN GLOBE

- (a) Appearance. The Acorn Globe must conform in appearance and design to that shown on Electrical Standard Drawing Number 958.
- (b) Top. The spun aluminum top and bottom globe sections will be secured with a .5 inch overlap design using 4 #10-24 stainless steel pan head screws with 4 aluminum nutserts providing a mechanical lock. A sealant must also be applied to make the globe dust-proof.
- (c) Material. The globe bottom must consist of a clear DR acrylic lens having a minimum cross-section of 3/32",

Scope of Work 145

securely bonded to an aluminum base to provide a solid key for the set screws fastening it to the capital. The lens must provide maximum resistance to ultra-violet degradation along with maximum mechanical durability. The globe must have prismatic to obtain an IES Type 11/ III distribution. The globe must be attached to the capital with 4 5/16-18 hex head screws evenly spaced at 90S apart. Lock nuts must be provided.

- (d) Optional House Side Reflector. A house-side reflector shall be provided if requested. The reflector shall be mounted to a removable bracket. The reflector shall be mounted on the bracket and attached by a spring clamp, or other suitable means. The reflector shall be constructed of aluminum and polished to a high specular finish. Reflectance of the reflecting surfaces shall not be less than 75%. Measurements shall be made with a reflectometer using the fiber-optic method. The reflector shall be sized so that it fits through the globe neck and the globe can be removed without any interference from the reflector.
- (e) Gaskets. Gasketing must be provided for the interface of the globe and capital to effectively provide a dustproof optical assembly. This proposed gasketing material must be shown to have been effective in other applications for a minimum period of five (5) years. Should the optical system also require a filter, it must be a charcoal "breathing" filter of adequate size to provide effective filtering of particle and gaseous contaminants.
- (f) Alternate Designs. Other globe designs providing the required photometries and giving equal performance and structural rigidity will be considered. However, no alternates will be allowed without the express written consent of the Commissioner.
- (g) The completed luminaire must be listed by an independent, nationally recognized testing laboratory to verify that the luminaire does not present an electrical or fire hazard.

E. Ingress Protection.

1. The luminaire electric compartment housing must have an ingress protection rating of IP54 or better as described , in ANSI C136.25-2013). The optical system must have a minimum rating of IP 66.
2. The luminaire must be listed for wet locations by a U.S. Occupational Safety Health Administration (OSHA) Nationally Recognized Laboratory (NRTL) and have a safety certification and file number indicating compliance with UL 1598.

F. General Luminaire Requirements

1. The luminaire must be rated to operate between -40° to +50° Celsius.

2. The luminaire must have the option of adding a house side shield. The shield should be designed to be easily installed in the field. The house side shield must be composed of a sturdy material capable of withstanding vibrations and weather conditions. The shield must cut off light trespass at approximately one mounting height behind the pole.
3. The luminaire must meet the requirements of ANSI C136.22 for internal labeling. A bar code with pertinent information for warranty and maintenance must be attached to the inside of the housing. A separate bar code label must be on the driver
4. The luminaire must be able to provide pertinent product information, for warranty and maintenance purposes, in a digital format that is compliant with the Digital Addressable Lighting Interface (DALI) protocol. This information will be transmitted through the networked Lighting Management control system.

G. Electrical Components

1. LED Optical Arrays

- a. The LED arrays must be properly secured at the factory and must not require field adjustment for optimum photometric performance.

Scope of Work 146

2. Terminal Block

- a. A terminal block of high grade molded plastic of the barrier or safety type must be mounted within the housing in a readily accessible location.
- b. Terminal block wiring; all necessary terminals, pre-wired to all luminaire components, must be provided.
- c. Terminal block terminals must have copper plated or brass plated, clamp-type pressure connectors of an approved type for "line" connections, to accommodate wire sizes from #12 to #8 A.W.G.
- d. Terminal block terminals for internal component connections must be either the screw-clamp or quick disconnect type.

3. LED Driver:

- a. Voltage. The electronic driver must operate at an input voltage range of between 120 and 277 volts, 60 Hertz. It must automatically sense the input voltage and adjust the output accordingly. The City uses nominal input voltages of 120, 208, and 240 for street lighting. When operated at any supply voltage between 80 percent and 110 percent of its rated supply voltage and at rated input frequency, a driver shall provide current and/or voltage regulation that equals or exceeds the values specified by the manufacturer.
- b. Electrical Safety. Luminaires must operate at or below the Low-Risk Level, as defined in Figure 18 of IEEE 1789-2015. This requirement must be satisfied across the dimming range.
- c. Power Factor (PF). The power factor of the driver over the design range of input voltages specified above must be in accordance to ANSI C82.77-2014. PF must be > 0.9.
- d. Total Harmonic Distortion (THD). The driver input current must have specified THD in accordance to ANSI C82.77-2014. THD must be <32%.
- e. Thermal Protection. The driver must be thermally protected to shut off when operating temperatures reach unacceptable levels.
- f. Electromagnetic Interference. Luminaire must comply with the FCC radiation emission limits for Class B digital devices given at 47 CFR 15.109.
- g. Electrical Transient Immunity.
 - Dielectric Withstand Testing - luminaire must meet the performance requirements specified in ANSI C136.2-2015 for dielectric withstand, using the DC test level and configuration.

- Electrical Transient Immunity - luminaire must meet the performance requirements specified in ANSI C136.2-2015 for electrical transient immunity, using the Enhanced (10 kV / 5 kA) combination wave test level.
- Transient Immunity Testing Requirements
- During electrical transient immunity testing, the device under test (DUT) must: be connected to the power source through a series coupler/decoupler network (CDN), using a two-wire (hot or hot/neutral) connection between both the power supply and CDN input and the CDN output and DUT.
- If AC mains is used to power the DUT, the input waveform must be characterized and documented both before and after electrical transient immunity testing, with the DUT operating at rated full output.

Scope of Work 147

- For Pre-Test DUT Characterization, the diagnostic measurements shall, at a minimum, include the following: real power, input current (RMS; Root-Means-Square), power factor, and current distortion factor (THD-I Total Harmonic Distortion) when operating at rated full output.
- Manufacturer must indicate on submittal form whether failure of the electrical transient immunity system can possibly result in disconnect of power to luminaire.

4. Wiring.

- a. All components must be completely factory wired with non-fading, color coded leads. These leads must be insulated with an approved class of insulation and must be #16 AWG conductor at a minimum.
- b. All wires within a single circuit path must be of the same size.
- c. No wire-nut splicing will be allowed.
- d. No unnecessary splices will be allowed.
- e. Quick disconnects must be provided for all components.
- f. All wires must be properly terminated.

5. Control Devices.

- a. Luminaire should have the optional capacity to be controlled by a 7-pin lighting control device either mounted externally or integral to the fixture housing.
- b. Control Devices Not Included in LED Specifications. Whereas specifications for control receptacles are included, specifications for control devices are not. The control device performance requirements are part of the lighting management system specifications in the Smart Lighting Project Technology specifications.

6. Component Mounting.

- a. All electrical components must be securely mounted in such manner that individual components can be easily maintained or replaced. Permanent straps or tie-wraps will not be permitted. The entire assembly should be easily disconnected and removed for replacement.

IV. PHOTOMETRIC REQUIREMENTS

1. Light Pollution.

To limit light pollution, the submitted luminaires must direct light downward.

2. Lumen Maintenance.

a. LED arrays must deliver a minimum of 90% of initial lumen output at 36,000 hours of operation.

b. Light Loss Factor (LLF) < 1.0. Calculations for maintained values, i.e. $LLF = LLD \times LDD \times LAT$.

- Lamp Lumen Depreciation (LLD) calculated at 60,000 hours as per Section II-B-3-d above;

Luminaire Dirt Depreciation (LDD) = 0.90, and

Scope of Work

- Luminaire Ambient Temperature (LAT) = 0.96

Luminaires with less than 10,000 hours of available LM-80 test data may be submitted for consideration but must be clearly indicated as such.

3. Color Attributes

a. Color Rendering Index (CRI) shall be no less than 65.

b. Nominal Correlated Color Temperature (CCT) shall be 3000K as defined by ANSI C78.377 and described below:

3000	2870 to 3220	Measured ^u y, -0.006 to 0.006
------	--------------	---

4. City of Chicago Typical Lighting Contexts

Performance Requirements using this luminaire only (normally this luminaire will be used in conjunction with another luminaire):

a. Roadway Illuminance:

Average Horizontal 0.48fc Uniformity Ratio Av/Min 5:1

b. Roadway Luminance:

Average Luminance 0.5 cd/m²

Uniformity Ratio Av/Min 5:1:1 Uniformity
Ratio Max/Min 26:1

c. Typical Roadway. Lighting should be designed for the specific roadway designated in the project. If there is no specific location, typical roadway values should be used. Typical values are as follows:

1. Right-of way
2. Curb-to-curb
3. Mounting height
4. Setback

Max. LED case temperature

degrees Celsius

ISTMT report

Scope of Work

DRAWING 958

LUMINAIRE SPECIFICATIONS

CAST ALUMINUM

ROOF
SPUK ALUMINUM

REFRACTOR GLOBE | PRISMATIC ACRYLIC MOOIFIED (CUT SHORTER) (TYPE III OPTICS)

GLOBE .HOLDER' CAST ALUMINUM

GLOBE HOLOCR FASTENERS| STAINLESS STEEL (HEX. HEAD) 5/16" - 18 (4t<S I

BALLAST ENCLOSURE| DIE-CAST ALUMINUM

SLIP PITTER| 3" 1.0.

SLIP FITTER FASTENERS' STAINLESS STEEL (ALLEN HEAO) 5/16"-18 (3*120)
FINISH| POWDER COATED ALUMINUM OR GLOSS BLACK

OMIT (VIP/IK)

LUMINAIRE RESIDENTIAL MID-MOUNT

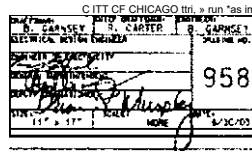

.New Df3wings1958-Adgn V2&/2011 2 23 35 PM

Scope of Work

ELECTRICAL SPECIFICATION No. 1603
CITY OF CHICAGO DEPARTMENT OF
TRANSPORTATION DIVISION OF
ENGINEERING DECEMBER 9, 2016

OUTDOOR LED LUMINAIRE SPECIFICATIONS:
ARTERIAL STREETS (Acorns)

I. **SUBJECT**

A. This specification states the requirements for an ornamental Light Emitting Diode (LED) Acorn outdoor lighting luminaires. The specified LED luminaires will be used to replace existing High Pressure Sodium (HPS) and Ceramic Metal Halide (CMH) Acorn luminaires on Chicago arterial streets. The LED luminaires will be integrated into a centralized lighting management system.

II. GENERAL

A. References

American National Standards Institute (ANSI)

- ANSI C78.377-2015, "American National Standard for Electric Lamps-Specifications for the Chromaticity of Solid State Lighting (SSL) Products"
- ANSI C82.77-10-2014, "American National Standard for Lighting Equipment-Harmonic Emission Limits-Related Power Quality Requirements"
- ANSI C136.2-2015, "American National Standard for Roadway and Area Lighting Equipment-Dielectric Withstand and Electrical Transient Immunity Requirements"
- ANSI C136.10-2010, "American National Standard for Roadway and Area Lighting Equipment-Locking-Type Control Devices and Mating Receptacles-Physical and Electrical Interchangeability and Testing"
- ANSI C136.15-2015, "American National Standard for Roadway and Area Lighting Equipment -Luminaire Field Identification"
- ANSI C136.22-2004 (R2009, R2014), "American National Standard for Roadway and Area Lighting Equipment-Internal Labeling of Luminaires"
- ANSI C136.25-2013, "American National Standard for Roadway and Area Lighting Equipment-Ingress Protection (Resistance to Dust, Solid Objects and Moisture) for Luminaire Enclosures"
- ANSI C136.31-2015, "American National Standard for Roadway and Area Lighting Equipment-Pole Vibration"
- ANSI C136.37-2011, "American National Standard for Solid State Light Sources Used in Roadway and Area Lighting"
- ANSI C136.41-2013, "American National Standard for Roadway and Area Lighting Equipment-Dimming Control Between an External Locking Type Control and Ballast or Driver"
- ASTM B85/B85M-14, "Standard Specification for Aluminum-Alloy Die Castings"
- ASTM B117-16, "Standard Practice for Operating Salt Spray (Fog) Apparatus"
- ASTM D523-14, "Standard Test Method for Specular Gloss"
- ASTM D1654-08, "Standard Test Method for Evaluation of Painted or Coated Specimens Subjected to Corrosive Environments"
- ASTM G154-12a, "Standard Practice for Operating Fluorescent Ultraviolet (UV) Lamp Apparatus for Exposure of Nonmetallic Materials"

Illuminating Engineering Society of North America (IES)

- ANSI/IES LM-63-02, "Standard File Format for Electronic Transfer of Photometric Data"
- IES LM-79-08, "Approved Method: Electrical and Photometric Measurements of Solid-State Lighting Products"

Scope of Work

- ANSI/IES LM-80-15, "IES Approved Method: Measuring Luminous Flux and Color Maintenance of LED Packages, Arrays and Modules"
- ANSI/IES RP-8-14, "Roadway Lighting"
- IES TM-21-11 (with Addendum B), "Projecting Long Term Lumen Maintenance of LED Light Sources"

Institute of Electrical and Electronics Engineers (IEEE)

- IEEE Std 1789-2015, "IEEE Recommended Practices for Modulating Current in High-Brightness LEDs for Mitigating Health Risks to Viewers"

International Electrotechnical Commission (IEC)

- IEC 60929:2011 (with Amendment 1), "AC and/or DC-supplied electronic control gear for tubular fluorescent lamps - Performance requirements"

Underwriters Laboratories (UL)

- ANSI/UL 1598 (3rd Edition), "Luminaires"

B. Submittal Requirements:

The Contractor must submit the following information pertaining to each specified luminaire type within fifteen (15) days of request:

1. Completed ATTACHMENT G - Submittal Form
2. Product Data Sheets.
 - a. Luminaire data sheets - including summary product description, dimensioned outline drawings, and nominal characteristics including but not limited to: initial luminous flux (lumens), input power (watts), input voltage range (volts), LED drive current (milliamps), correlated color temperature (kelvins), color rendering index, effective projected area (square feet) and weight (pounds).
 - b. LED Driver data sheet - including information described in LED Driver Requirements Section III-I-3.
 - c. LED light source data sheet
 - d. Surge protection device data sheet - if applicable

3. Photometric Performance Data

c.

The manufacturer must provide photometric calculations, as part of each luminaire's submittal package, that demonstrate the luminaire's photometric performance will meet or exceed the photometric requirements listed in this specification. The submitted lighting calculations must include point-by-point illuminance, luminance and veiling luminance data, as well as listings of all indicated averages and ratios. Photometric reports must include the following information and be in accordance with the standards listed below: IES LM-79-08 photometric report that includes measured values for initial luminous flux, input power, correlated color temperature, and color rendering index.

ANSI/IES LM-63-02 electronic format photometric file that corresponds to the LM-79 report.

LM-63 photometric calculations that demonstrate compliance with the illumination requirements specified herein using the LM-63 file. Calculation grids and observer locations not specified herein must be in accordance with

154

ANSI/IES RP-8-14.

- e. IES TM-21-11 calculations that derive the lumen maintenance (lamp lumen depreciation or LLD) factor applied to photometric calculations specified herein.
 - ANSI/IES LM-80-15 and in-situ temperature measurement testing (ISTMT) reports containing data used in TM-21 calculations must also be submitted. TM-21 calculations must apply to the maximum LED case temperature from ISTMT, shall not extrapolate beyond six times the duration of available LM-80 test data, and must be submitted in the spreadsheet format of the ENERGY STAR TM-21 calculator (<https://www.enerevstar.gov/products/spec/luminaires> <<http://www.enerevstar.gov/products/spec/luminaires>> specification version 2 0 pd).LM-79, ISTMT, and LM-80 reports must correspond directly to submitted luminaires, and must be produced by test laboratories that satisfy the Testing Laboratory Requirements of the DesignLights Consortium (www.designlights.org/content/QPL/ProductSubmit/LabTesting <<http://www.designlights.org/content/QPL/ProductSubmit/LabTesting>>). ISTMT must be conducted in accordance with the DesignLights Consortium Manufacturer's Guide (<https://www.designlights.org/content/qpl/productssubmit> <<http://www.designlights.org/content/qpl/productssubmit>>).

ISTMT shall be conducted in an ambient temperature of 25 ± 5 °C. Ambient temperature variations above or below 25 °C shall be respectively subtracted from or added to temperatures recorded at points on the luminaire.

4. Safety Certification - file number indicating compliance with UL 1598. Applicable testing bodies are determined by the US Occupational Safety Health Administration (OSHA) as Nationally Recognized Testing Laboratories (NRTL) and include: CSA (Canadian Standards Association), ETL (Edison Testing Laboratory), and UL (Underwriters Laboratory).
5. Vibration Testing - the luminaire must comply with ANSI C136.31 at Vibration Test Level 2 (3.0 G).
6. Product Samples - at least two samples of each luminaire that the contractor proposes to use must be submitted to the City. All samples

must be representative production units and be supplied at no cost to the City.

C. Assembly.

Each luminaire must be delivered completely assembled, wired, and ready for installation.

D. Warranty.

The luminaire manufacturer must warrant the performance and construction of luminaires to meet the requirements of this specification, and must warrant all parts, components and appurtenances against defects due to design, workmanship or material developing within a period of ten (10) years from the date of acceptance by the City.

- The inability of a luminaire to be dimmed will constitute a luminaire failure.
- Failure of 10% or more of the LED light sources (packages or arrays/modules) in a luminaire will constitute a luminaire failure.
- The warranty must apply for application on all of the City's existing electrical systems, both grounded and ungrounded.
- During the warranty period the City may, from time to time, test a random sampling of 10-20 luminaires for verification of light output per IES LM-79 and to test dimming functionality for a given luminaire population. The percentage of luminaires not performing as required in the random sampling will be applied to the total population quantity to determine the number of new luminaire replacements that must be delivered to the City by the manufacturer, without expense to the City.

155

E. Manufacturing Experience and Capacity

The manufacturer must demonstrate at least a five year history of manufacturing LED roadway and outside area luminaires by providing a list of prior projects with project description, date, location, quantities and reference contact information. The manufacturer must also demonstrate the capacity to supply the quantities required for the contract in a timely manner.

III. CONSTRUCTION

A. Housing[^]

The preferred luminaire housing material is die-cast aluminum alloy meeting ASTM Specification A380. Alternate materials may be considered. The housing must enclose the mounting hardware, LED arrays, control receptacle, terminal board, and electronic driver. The housing must include a surface to facilitate leveling with a spirit level. The housing must have integral heat sink characteristics, such that all enclosed components will operate within their designed operating temperatures under expected service conditions. No external or removable heat shields or heat sinks; are permitted. The housing must be designed to encourage water shedding. The housing must be designed to minimize dirt and bug accumulation on the optic surface.

B. Mounting Provisions.

The luminaire must include a heavy gauge slip fitter clamping assembly suitable for secure attachment. The luminaire is to be attached to an existing cast aluminum or steel tenon which is 3" O.D. and 3" long with an approved means of clamping it firmly in mounting bracket.

C. Capitals And Finials.

- (a) Material. Each capital and finial shall be cast aluminum, conforming to American Die Casting Standard ADC-1-C9-83 Grade 380.
- (b) Appearance. They must conform in detail with the capital and finial shown on Drawing 912.
- (c) Construction. Castings must have smooth external surfaces free from protuberances, dents, cracks, or other imperfections marring their appearance. Welding or plugging of casting defects is prohibited.
- (d) Structural Integrity. The capital attachment to the tenon shall provide the structural integrity to hold the luminaire firmly in place during the vibrations anticipated due to passing elevated trains and heavily loaded vehicles. Where set screws are used to secure the capital to the tenon, a minimum of 3/16" thickness of metal must be provided where the set screws are inserted to minimize the possibility of stripping the threads when the set screws are tightened into place. The set screws must be 5/16-18, hex head, stainless steel; a minimum of three set

screws must be provided. The finial shall be securely attached to the acorn globe such that it will remain an integral part of the acorn globe during the vibrations described above.

- (e) Gaskets. Gasketing may be provided for the interface of the globe and capital to effectively provide a dustproof optical assembly. Should the optical system also require a filter, it must be a charcoal "breathing" filter of adequate size to provide effective filtering of particulate and gaseous contaminants.

D. Capital And Finial Painting

- (a) Oil and Grease Removal. All metal surfaces shall be washed with an alkaline detergent to remove any oils or grease.

- (b) Chemical Pretreatment. The cleaned metal surfaces must then be treated with a hot, pressurized phosphate wash and must be dried by convection heat.

- (a) Exterior and Interior Coat. A thermosetting, weathering, Polyester powder coat shall be applied electrostatically

156

to all cleaned and treated surfaces to a uniform four-mil(4.0) thickness in a one coat application. This powder coat must be cured in a convection oven at a minimum temperature of 400^s Fahrenheit to form a high molecular weight fusion bonded finish.

- (d) Alternate Methods. Alternate powder coat methods may be reviewed and tested on a case-by-case basis. However, no coating method will be accepted unless the Commissioner judges such alternate to be equal to the coating herein specified.

- (e) Durability. Both the exterior and interior coats shall be capable of passing 1,000 hours of salt spray exposure as per ASTM B117 in a 5% Na Cl (by weight) solution at 95^o Fahrenheit and 95% relative humidity without blistering. Before test, the panel must be scribed with an "X" down to the bare metal.

- (f) Coating Measurement. Measurement of coating thickness shall be done in accordance with SSPC-PA 2-73T, "Measurement of Dry Paint Thickness with Magnetic Gauges," except that the lowest "single spot measurement" in an area of two square inches must be not less than 3.0 mils.

- (g) Color. Color shall be gloss black. A color sample must be submitted for approval prior to fabrication. This color sample must include the manufacturer's name and the manufacturer's color name as well as any other information which will be required to purchase the same color for the masts, mast arms, and split pedestal bases.

E. Component Mounting

- (a) Modular Construction All electrical components shall be securely mounted to a plate which is attached to the capital by means of easily removable stainless steel captive thumb screws or by easily operated stainless steel latches. Removal of the plate must be tool-less. Provisions must be included to secure the component mounting plate in its "disconnected" position to allow easy access to terminal blocks and components for installation and maintenance.

- (b) Interchangeability. Component mounting plates shall be mutually field interchangeable so that units can be restored to working condition without trouble shooting components.

- (c) Other Methods. Other methods of component mounting may be considered if they are judged to provide the same ease of installation and maintainability. No alternates will be allowed without the specific written approval of the Commissioner

- (d) Optional Receptacle. If desired, A 120 Volt, grounded receptacle must be provided in an easily accessible location in the capital. It must be separately wired to its own polarized quick disconnect connector. The access door for the component mounting plate must be notched to provide for securing the door with a three wire, #12 AWG, Type S.O. cord plugged into the outlet.

F. Acorn Globe And Reflector

- (a) Appearance. Globe shall conform to that shown on Drawing 912.

- (b) Material/Construction. Globe shall be constructed of clear, V825 HID acrylic utilizing a slip-fit 1/2" overlap, two piece which eliminates

a "butt-glue" seam appearance.

The bottom optical section of the globe must have a neck opening of 7-1/4" at the smallest diameter and an outside dimension of 8" at the bottom; be a minimum of 12-3/4" in height and 16 1/2" in width at the top.

The top section of the globe must be "Victorian" in appearance; a minimum of 13" in height and 16.313" in width with 100 horizontal prisms to evenly diffuse light. If so requested, a full top reflector of the same diameter as the globe shall be installed between the halves and secured to the globe. The top and bottom sections shall be secured in a slip-fit overlap design using four #10 -24 x 5/8 stainless steel pan head screws with four aluminum nutserts providing a mechanical lock. In

157

addition, a sealant must be applied to the two halves to provide a dust-proof seal.

(c) Globe Mounting. The globe shall be mounted with four 5/16-18 hex head, stainless steel bolts with stop nuts mounted into the die cast fixture housing. They must securely contact an aluminum globe neck ring connected to the acorn globe. The globe must be clearly marked and keyed so that it will be properly installed to provide the required house side/street side photometries. The mounting must afford the rigidity necessary to prevent the globe from twisting or rattling when subjected to the vibrating forces of passing elevated trains or heavily loaded vehicles. The mounting must not preclude any globe from being mutually interchangeable with any other globe intended for this function.

(d) Reflectors. A top reflector and a house-side reflector shall be provided. These reflectors shall be mounted to a removable bracket. The small dome shaped top reflector, approximately 6.5 inches in diameter and 3 inches deep shall be mounted on the bracket and attached by a spring clamp, or other suitable means, to the lamp socket or lamp socket holder. The side reflector shall be mounted to the same bracket. The reflectors shall be constructed of aluminum and polished to a high specular finish. Reflectance of the reflecting surfaces shall not be less than 75%. Measurements shall be made with a reflectometer using the fiber-optic method.

(e) Optional Reflector. If so ordered in the line item of a contract, a full top reflector will be provided as part of the globe. This reflector will be inserted between the two halves of the globe and permanently sealed to the globe halves. This reflector will not allow any light from the lamp to enter the top half of the globe.

G. General Luminaire Requirements

1. The luminaire must be rated to operate between -40° to +50° Celsius.
2. The luminaire must meet the requirements of ANSI C136.22 for internal labeling. A bar code with pertinent information for warranty and maintenance must be attached to the inside of the housing. A separate bar code label must be on the driver
3. The luminaire must be able to provide pertinent product information, for warranty and maintenance purposes, in a digital format that is compliant with the Digital Addressable Lighting Interface (DALI) protocol. This information will be transmitted through the networked Lighting Management control system.

H. Electrical Components

1. LED Optical Arrays
2. The LED arrays must be properly secured at the factory and must not require field adjustment for optimum photometric performance.
3. Terminal Block
 - a. A terminal block of high grade molded plastic of the barrier or safety type must be mounted within the housing in a readily accessible location.
 - b. Terminal block wiring; all necessary terminals, pre-wired to all luminaire components, must be provided.
 - c. Terminal block terminals must have copper plated or brass plated, clamp-type pressure connectors of an approved type for "line" connections, to accommodate wire sizes from #12 to #8 A.W.G.

d. Terminal block terminals for internal component connections must be either the screw-clamp or quick disconnect type.

4. LED Driver:

f. Voltage. The electronic driver must operate at an input voltage range of between 120 and 277 volts, 60 Hertz. It

158

must automatically sense the input voltage and adjust the output accordingly. The City uses nominal input voltages of 120, 208, and 240 for street lighting. When operated at any supply voltage between 80 percent and 110 percent of its rated supply voltage and at rated input frequency, a driver shall provide current and/or voltage regulation that equals or exceeds the values specified by the manufacturer.

g. Electrical Safety. Luminaires must operate at or below the Low-Risk Level, as defined in Figure 18 of IEEE 1789-2015. This requirement must be satisfied across the dimming range.

h. Power Factor (PF). The power factor of the driver over the design range of input voltages specified above must be in accordance to ANSI C82.77-2014. PF must be > 0.9.

i. Total Harmonic Distortion (THD). The driver input current must have specified THD in accordance to ANSI C82.77-

2014. THD must be <32%.

j. Thermal Protection. The driver must be thermally protected to shut off when operating temperatures reach unacceptable levels.

k. Electromagnetic Interference. Luminaire must comply with the FCC radiation emission limits for Class B digital devices given at 47 CFR 15.109.

l. Electrical Transient Immunity.

- Dielectric Withstand Testing - luminaire must meet the performance requirements specified in ANSI C136.2-2015 for dielectric withstand, using the DC test level and configuration.
- Electrical Transient Immunity - luminaire must meet the performance requirements specified in ANSI C136.2-2015 for electrical transient immunity, using the Enhanced (10 kV / 5 kA) combination wave test level.
- Transient Immunity Testing Requirements
- During electrical transient immunity testing, the device under test (DUT) must: be connected to the power source through a series coupler/decoupler network (CDN), using a two-wire (hot or hot/neutral) connection between both the power supply and CDN input and the CDN output and DUT.
- If AC mains is used to power the DUT, the input waveform must be characterized and documented both before and after electrical transient immunity testing, with the DUT operating at rated full output.
- For Pre-Test DUT Characterization, the diagnostic measurements shall, at a minimum, include the following: real power, input current (RMS; Root-Means-Square), power factor, and current distortion factor (THD-I Total Harmonic Distortion) when operating at rated full output.
- Manufacturer must indicate on submittal form whether failure of the electrical transient immunity system can possibly result in disconnect of power to luminaire.

5. Wiring.

- a. All components must be completely factory wired with non-fading, color coded leads. These leads must be insulated with an approved class of insulation and must be #16 AWG conductor at a minimum.
- b. All wires within a single circuit path must be of the same size.
- c. No wire-nut splicing will be allowed.
- d. No unnecessary splices will be allowed.
- e. Quick disconnects must be provided for all components.
- f. All wires must be properly terminated.

6. Control Device Receptacle and Cap.

- a. Twist-lock Receptacle for a control device that meets ANSI C136.41 must be mounted in the top of the housing with provision for proper positioning of the control device.
- b. 7-pin Receptacle. The luminaire control receptacle must be fully prewired and compliant with ANSI C136.41.
- c. 3-prong Shorting Cap that meets ANSI C136.10 must be provided.
- d. Receptacle Wire Leads must all be properly terminated.
- e. Receptacle repositioning. The receptacle must be able to be repositioned without the use of tools.
- f. Control Devices Not Included in LED Specifications. Whereas specifications for control receptacles are included, specifications for control devices are not. The control device performance requirements are part of the lighting management system specifications in the Smart Lighting Project Technology specifications.

7. Component Mounting

All electrical components must be securely mounted in such manner that individual components can be easily maintained or replaced. Permanent straps or tie-wraps will not be permitted. The entire assembly should be easily disconnected and removed for replacement.

IV. PHOTOMETRIC REQUIREMENTS

1. Light Pollution.

- 2. To limit light pollution, the submitted luminaires must direct light downward. Lumen Maintenance.
- 3. LED arrays must deliver a minimum of 90% of initial lumen output at 36,000 hours of operation.
 - a. Light Loss Factor (LLF) < 1.0. Calculations for maintained values, i.e. $LLF = LLD \times LDD \times LAT$.
 - 1. Lamp Lumen Depreciation (LLD) calculated at 60,000 hours as per Section II-B-3-d above;
 - 2. Luminaire Dirt Depreciation (LDD) = 0.90, and
 - 3. Luminaire Ambient Temperature (LAT) = 0.96

Luminaires with less than 10,000 hours of available LM-80 test data may be submitted for consideration but must be clearly indicated as such.

4. Color Attributes

- a. Color Rendering Index (CRI) shall be no less than 65.
- b. Nominal Correlated Color Temperature (CCT) shall be 3000K as defined by ANSI C78.377 and described below:

Measured CCT (K)	Measured CCT (Kj)	Wa'sufje2B ^u M
3000	2870 to 3220	-0.006 to 0.006

- 5. Performance Requirements: a.
Roadway Luminance:
1.2 cd/m²

Average Luminance

Uniformity Ratio Av/Min3:1

Uniformity Ratio Max/Min5:1

Max Veiling Luminance0.5

- b. The photometries shall be run for the specific project requirements. If the luminaires are to be obtained for no specific project, the luminaires must meet the performance requirements for the following physical conditions.

Right of way80'

Curb-to-curb48'

Mounting height 16'

Setback - 4'

Arm length0'

Spacing (opposite)80'

PavementR3

ATTACHMENT G - Product Submittal Form

Lighting Context

e.g. Arterial Acorns

<i>Product Information/Description</i>	<i>Product Data , • : (Summary)</i>	<i>Submittal Reference Document</i>
Luminaire Designation		
Luminaire Manufacturer		
Luminaire Model Number		
Luminous Flux - initial	lumens	
Luminaire input power-initial	watts	
Luminaire input power-maintained	watts	
Luminaire input voltage- nominal range	volts	
LED drive current - initial	milliamps	
LED drive current - maintained	milliamps	
CCT (correlated color temperature)	kelvin	
CRI (color rendering index)		
EPA (effective projected area) - nominal	sq. ft.	
Luminaire Weight - nominal	lbs.	
Control Interface	<input type="checkbox"/> ANSI C136.41, 7-pin	
LED Driver - dimming capability	<input type="checkbox"/> Dimmable, 0-10V <input type="checkbox"/> Dimmable, DALI	
LED driver- rated life	years	
Electrical transient immunity ANSI C136.2 combination wave test level	<input type="checkbox"/> Basic (6kV/3kA) <input type="checkbox"/> Enhanced (10kV/5kA) <input type="checkbox"/> Elevated (20kV/10kA)	
Vibration Test-ANSI C136.31	<input type="checkbox"/> Level 2	
Luminaire warranty period	years	
IES LM-80 test duration	hours	IES LM-80-15 rep
LED lumen maintenance at 36,000 hours	0/10	TM-21 calculator

Max. LED case temperature degrees Celsius ISTMT report

DRAWING 912

164

ELECTRICAL SPECIFICATION No. 1604
CITY OF CHICAGO DEPARTMENT OF
TRANSPORTATION DIVISION OF ENGINEERING
DECEMBER 09, 2016

**OUTDOOR LED LUMINAIRE SPECIFICATIONS: UNDERPASS
AND VIADUCT**

SUBJECT

A. This specification states the requirements for non-ornamental Light Emitting Diode (LED) outdoor lighting luminaires. The specified LED luminaires will be used to replace existing High Pressure Sodium (HPS) and Ceramic Metal Halide (CMH) luminaires on Chicago underpasses and viaducts. The input voltage shall be between 120 and 240 volts. The luminaires shall be mounted to the structures utilizing adjustable trunnion type brackets. The LED luminaires shall have the capacity to be integrated into a centralized lighting management system.

GENERAL

A. References

American National Standards Institute (ANSI)

- ANSI C78.377-2015, "American National Standard for Electric Lamps-Specifications for the Chromaticity of Solid State Lighting (SSL) Products"
- ANSI C82.77-10-2014, "American National Standard for Lighting Equipment-Harmonic Emission Limits-Related Power Quality Requirements"
- ANSI C136.2-2015, "American National Standard for Roadway and Area Lighting Equipment -Dielectric Withstand and Electrical Transient Immunity Requirements"
- ANSI C136.10-2010, "American National Standard for Roadway and Area Lighting Equipment-Locking-Type Control Devices and Mating Receptacles-Physical and Electrical Interchangeability and Testing"
- ANSI C136.15-2015, "American National Standard for Roadway and Area Lighting Equipment-Luminaire Field Identification"
- ANSI C136.22-2004 (R2009, R2014), "American National Standard for Roadway and Area Lighting Equipment-Internal Labeling of Luminaires"
- ANSI C136.25-2013, "American National Standard for Roadway and Area Lighting Equipment-Ingress Protection (Resistance to Dust, Solid Objects and Moisture) for Luminaire Enclosures"
- ANSI C136.31-2015, "American National Standard for Roadway and Area Lighting Equipment -Pole Vibration"
- ANSI C136.37-2011, "American National Standard for Solid State Light Sources Used in Roadway and Area Lighting"
- ANSI C136.41-2013, "American National Standard for Roadway and Area Lighting Equipment-Dimming Control Between an External Locking Type Control and Ballast or Driver"

American Society for Testing and Materials (ASTM)

- ASTM B85/B85M-14, "Standard Specification for Aluminum-Alloy Die Castings"
- ASTM B209-14, "Standard Specification for Aluminum and Aluminum Alloy Sheet and Plate"
- ASTM B117-16, "Standard Practice for Operating Salt Spray (Fog) Apparatus"
- ASTM D523-14, "Standard Test Method for Specular Gloss"
- ASTM D1654-08, "Standard Test Method for Evaluation of Painted or Coated Specimens Subjected to Corrosive Environments"

165

ASTM G154-12a, "Standard Practice for Operating Fluorescent Ultraviolet (UV) Lamp Apparatus for Exposure of Nonmetallic Materials"

Illuminating Engineering Society of North America (IES) ANSI/IES LM-63-02, "Standard File Format for Electronic Transfer of Photometric Data" IES LM-79-08, "Approved Method: Electrical and Photometric Measurements of Solid-State Lighting Products" ANSI/IES LM-80-15, "IES Approved Method: Measuring Luminous Flux and Color Maintenance of LED Packages, Arrays and Modules" ANSI/IES RP-8-14, "Roadway Lighting" ANSI/IES RP-22-11, "Tunnel Lighting" IES TM-21-11 (with Addendum B), "Projecting Long Term Lumen Maintenance of LED Light Sources"

Institute of Electrical and Electronics Engineers (IEEE) IEEE Std 1789-2015, "IEEE Recommended Practices for Modulating Current in High-Brightness LEDs for Mitigating Health Risks to Viewers" . IEC 60529-2004, "Degrees of Protection Provided by Enclosures (IP Code)"

International Electrotechnical Commission (IEC) IEC 60929:2011 (with Amendment 1), "AC and/or DC-supplied electronic control gear for tubular fluorescent lamps - Performance requirements"

Underwriters Laboratories (UL) ANSI/UL 1598 (3rd Edition),
"Luminaires"

Submittal Requirements:

The Contractor must submit the following information:

1. Completed ATTACHMENT A - Submittal Form
2. Product Data Sheets.
 - a. Luminaire data sheets - including summary product description, dimensioned outline drawings, and nominal characteristics including but not limited to: initial luminous flux (lumens), input power (watts), input voltage range (volts), LED drive current (milliamps), correlated color temperature (kelvins), color rendering index, effective projected area (square feet) and weight (pounds).
 - b. LED Driver data sheet - including information described in LED Driver Requirements Section III-I-3.
 - c. LED light source data sheet
 - d. Surge protection device data sheet - if applicable

3. Photometric Performance Data

The manufacturer must provide photometric calculations, as part of each luminaire's submittal package, that demonstrate the luminaire's photometric performance will meet or exceed the photometric requirements listed in this specification. The submitted lighting calculations must include point-by-point illuminance, luminance and veiling luminance data, as well as listings of all indicated averages and ratios. Photometric reports must include the following information and be in accordance with the standards listed below:

- a. IES LM-79-08 photometric report that includes measured values for initial luminous flux, input power, correlated color temperature, and color rendering index.
- b. ANSI/IES LM-63-02 electronic format photometric file that corresponds to the LM-79 report.
- c. LM-63 photometric calculations that demonstrate compliance with the illumination requirements specified herein using the LM-63 file. Calculation grids and observer locations not specified herein must be in accordance with ANSI/IES RP-8-14.
- d. IES TM-21-11 calculations that derive the lumen maintenance (lamp lumen depreciation or LLD) factor applied to photometric calculations specified herein.
 - ANSI/IES LM-80-15 and in-situ temperature measurement testing (ISTMT) reports containing data used in TM-21 calculations must also be submitted. TM-21 calculations must apply to the maximum LED case temperature from ISTMT, shall not extrapolate beyond six times the duration of available LM-80 test data, and must be submitted in the spreadsheet format of the ENERGY STAR TM-21 calculator (<https://www.energystar.gov/products/spec/luminaires> <<http://www.energystar.gov/products/spec/luminaires>> specification version 2.0 pd).LM-79, ISTMT, and LM-80 reports must correspond directly to submitted luminaires, and must be produced by test laboratories that satisfy the

Testing Laboratory Requirements of the DesignLights Consortium (www.designlights.org/content/QPL/ProductSubmit/LabTesting <<http://www.designlights.org/content/QPL/ProductSubmit/LabTesting>>).
ISTMT must be conducted in accordance with the DesignLights Consortium Manufacturer's Guide (<https://www.designlights.org/content/qpl/productssubmit> <<http://www.designlights.org/content/qpl/productssubmit>>).

167

ISTMT shall be conducted in an ambient temperature of 25 ± 5 °C. Ambient temperature variations above or below 25 °C shall be respectively subtracted from or added to temperatures recorded at points on the luminaire.

4. Safety Certification - file number indicating compliance with UL 1598. Applicable testing bodies are determined by the US Occupational Safety Health Administration (OSHA) as Nationally Recognized Testing Laboratories (NRTL) and include: CSA (Canadian Standards Association), ETL (Edison Testing Laboratory), and UL (Underwriters Laboratory).
5. Vibration Testing - the luminaire must comply with ANSI C136.31 at Vibration Test Level 2 (3.0 G).
6. Product Samples - at least two samples of each luminaire that the contractor proposes to use must be submitted to the City. All samples must be representative production units and be supplied at no cost to the City.

C. Assembly.

Each luminaire must be delivered completely assembled, wired, and ready for installation.

D. Warranty.

The luminaire manufacturer must warrant the performance and construction of luminaires to meet the requirements of this specification, and must warrant all parts, components and appurtenances against defects due to design, workmanship or material developing within a period of ten (10) years from the date of acceptance by the City.

- The inability of a luminaire to be dimmed will constitute a luminaire failure.
- Failure of 10% or more of the LED light sources (packages or arrays/modules) in a luminaire will constitute a luminaire failure.
- The warranty must apply for application on all of the City's existing electrical systems, both grounded and ungrounded.
- During the warranty period the City may, from time to time, test a random sampling of 7-10 luminaires for verification of light output per IES LM-79 and to test dimming functionality for a given luminaire population. The percentage of luminaires not performing as required in the random sampling will be applied to the total population quantity to determine the number of new luminaire replacements that must be delivered to the City by the manufacturer, without expense to the City.

E. Manufacturing Experience and Capacity

The manufacturer must demonstrate at least a five year history of manufacturing LED roadway and outside area luminaires by providing a list of prior projects with project description, date, location, quantities and reference contact information. The manufacturer must also demonstrate the capacity to supply the quantities required for the contract in a timely manner.

II. CONSTRUCTION

A. Weight

The net weight of these luminaires must not be more than 30 pounds.

B. Housing^A

- The preferred luminaire housing material is die-cast aluminum alloy meeting ASTM Specification A380. Alternate materials may be considered.
- The housing must enclose the mounting hardware, LED arrays, control receptacle, terminal board, and electronic driver.
- The housing must include a surface to facilitate leveling with a spirit level.
- The housing must have integral heat sink characteristics, such that all enclosed components will operate within their designed operating temperatures under expected service conditions. No external or removable heat shields

168

or heat sinks; are permitted.

- The housing must be designed to encourage water shedding. The housing must be designed to minimize dirt and bug accumulation on the optic surface.
- The housing will have the general appearance of Electrical Standard Drawing 981.
- A wiring compartment capable of accepting a .75 inch threaded conduit fitting to accommodate an electrical whip must be included.

C. Mounting Provisions.

Each housing must have two trunnion type brackets. One bracket must be mounted to each end panel of the housing with appropriate screws or bolts. The brackets will allow the luminaire to be positioned up to 90° in either direction from the horizontal. The brackets must be marked on the outside indicating the degrees of angle. The brackets must provide for positive locking in the desired position.

D. Access Door-Panel.

A replaceable high impact UV resistant polycarbonate drop lens will cover the LED array. This lens will be attached to a door. The door must be of the same aluminum as the housing. The door will be hinged on one side such that when opened the door will fall open toward the roadway. The other side of the door will be attached to the housing with latches, allowing tool-less entry. The door will allow easy access to the driver and terminal strip (unless the terminal strip is in a separate accessible wiring compartment).

In order to make a dustproof assembly, a gasket of silicone rubber or other specifically approved material must be provided.

E. Hardware.

All fasteners necessary to make a firm assembly must be furnished in place. All hardware must be of stainless steel, copper silicon alloy or other non-corrosive metal, and where necessary must be suitably plated to prevent electrolytic action by contact with aluminum.

F. Finish.

The luminaire must have a polyester powder coat with a minimum 2.0 mil thickness. Surface texture and paint quality will be subject to approval. Color must be as specified in the order. A paint chip must be submitted as a sample upon request. The finish must exceed a rating of six per ASTM D1654 after 1000 hours of testing per ASTM B117. The coating must exhibit no greater than 30% reduction of gloss per ASTM D523 after 500 hours of QUV testing at ASTM G154 Cycle 6.

G. Ingress Protection.

The luminaire electric compartment housing must have an ingress protection rating of IP54 or better as described in ANSI C136.25-2013). The optical system must have a minimum rating of IP 66.

The luminaire must be listed for wet locations by a U.S. Occupational Safety Health Administration (OSHA) Nationally Recognized Laboratory (NRTL) and have a safety certification and file number indicating compliance with UL 1598.

H. General Luminaire Requirements

The luminaire must be rated to operate between -40° to +50° Celsius.

The luminaire must meet the requirements of ANSI C136.22 for internal labeling. A bar code with pertinent information for warranty and maintenance must be attached to the inside of the housing. A separate bar code label must be on the driver

The luminaire must be able to provide pertinent product information, for warranty and maintenance purposes, in a digital format that is compliant with the Digital Addressable Lighting Interface (DALI) protocol. This information will be transmitted through the networked Lighting Management control system.

The luminaire must be labeled for field identification according to ANSI C136.15.

I. Electrical Components

1. LED Optical Arrays

The LED arrays must be properly secured at the factory and must not require field adjustment for optimum photometric performance.

2. Terminal Block

- a. A terminal block of high grade molded plastic of the barrier or safety type must be mounted within the housing in a readily accessible location.
- b. Terminal block wiring; all necessary terminals, pre-wired to all luminaire components, must be provided.
- c. Terminal block terminals must have copper plated or brass plated, clamp-type pressure connectors of an approved type for "line" connections, to accommodate wire sizes from #12 to #8 A.W.G.
- d. Terminal block terminals for internal component connections must be either the screw-clamp or quick disconnect type.

3. LED Driver:

- a. Voltage. The electronic driver must operate at an input voltage range of between 120 and 277 volts, 60 Hertz. It must automatically sense the input voltage and adjust the output accordingly. The City uses nominal input voltages of 120, 208, and 240 for street lighting. When operated at any supply voltage between 80 percent and 110 percent of its rated supply voltage and at rated input frequency, a driver shall provide current and/or voltage regulation that equals or exceeds the values specified by the manufacturer.
- b. Electrical Safety. Luminaires must operate at or below the Low-Risk Level, as defined in Figure 18 of IEEE 1789-2015. This requirement must be satisfied across the dimming range.
- c. Power Factor (PF). The power factor of the driver over the design range of input voltages specified above must be in accordance to ANSI C82.77-2014. PF must be > 0.9.
- d. Total Harmonic Distortion (THD). The driver input current must have specified THD in accordance to ANSI C82.77-2014. THD must be <32%.
- e. Thermal Protection. The driver must be thermally protected to shut off when operating temperatures reach unacceptable levels.
- f. Electromagnetic Interference. Luminaire must comply with the FCC radiation emission limits for Class B digital devices given at 47 CFR 15.109.
- g. Electrical Transient Immunity.
 - Dielectric Withstand Testing - luminaire must meet the performance requirements specified in ANSI C136.2-2015 for dielectric withstand, using the DC test level and configuration.

170

Electrical Transient Immunity - luminaire must meet the performance requirements specified in ANSI C136.2-2015 for electrical transient immunity, using the Enhanced (10 kV / 5 kA) combination wave test level.

• Transient Immunity Testing Requirements

- During electrical transient immunity testing, the device under test (DUT) must: be connected to the power source through a series coupler/decoupler network (CDN), using a two-wire (hot or hot/neutral) connection between both the power supply and CDN input and the CDN output and DUT.

- If AC mains is used to power the DUT, the input waveform must be characterized and documented both before and after electrical transient immunity testing, with the DUT operating at rated full output.
- For Pre-Test DUT Characterization, the diagnostic measurements shall, at a minimum, include the following: real power, input current (RMS; Root-Means-Square), power factor, and current distortion factor (THD-I Total Harmonic Distortion) when operating at rated full output.
- Manufacturer must indicate on submittal form whether failure of the electrical transient immunity system can possibly result in disconnect of power to luminaire.

4. Wiring.

- a. All components must be completely factory wired with non-fading, color coded leads. These leads must be insulated with an approved class of insulation and must be #16 AWG conductor at a minimum.
- b. All wires within a single circuit path must be of the same size.
- c. No wire-nut splicing will be allowed.
- d. No unnecessary splices will be allowed.
- e. Quick disconnects must be provided for all components.
- f. All wires must be properly terminated.
- g. Control Devices Not Included in this LED Specifications. Whereas specifications for control receptacles will be included for the underpass or viaduct controller, specifications for control devices are not. The control device performance requirements are part of the lighting management system specifications in the Smart Lighting Project Technology specifications.

5. Component Mounting.

All electrical components must be securely mounted in such manner that individual components can be easily maintained or replaced. Permanent straps or tie-wraps will not be permitted. The entire assembly should be easily disconnected and removed for replacement.

PHOTOMETRIC REQUIREMENTS

1. Color Attributes

- a. Color Rendering Index (CRI) shall be no less than 65.
- b. Nominal Correlated Color Temperature (CCT) shall be 3000K as defined by ANSI C78.377 and described below:

Manufacturer-Rated Nominal	Allowable sE-sfLM-79 Chromaticity Values'	
	Measured (B'CC^K)	Measured Duty
3000	2870 to 3220	-0.006 to 0.006

2. Lumen Maintenance.

- a. LED arrays must deliver a minimum of 90% of initial lumen output at 36,000 hours of operation.

b. Light Loss Factor (LLF) < 1.0. Calculations for maintained values, i.e. LLF = LLD x LDD x LAT.

1. Lamp Lumen Depreciation (LLD) calculated at 60,000 hours as per Section II-B-3-d above;
2. Luminaire Dirt Depreciation (LDD) = 0.86", and
3. Luminaire Ambient Temperature Factor (LATF) = 0.96

Luminaires with less than 10,000 hours of available LM-80 test data may be submitted for consideration but must be clearly indicated as such.

3. Roadway Luminance:

Average Luminance Uniformity Ratio Av/Min Uniformity Ratio Max/Min Max Veiling Luminance

2.5 cd/m2 3:1 5:1 0.5

4. The photometries shall be run for the specific requirements. If the luminaires are to be obtained for no specific project, the luminaires must meet the performance requirements for the following physical conditions:

Right-of-way Curb-to-curb Mounting height 13' Tilt

Setback 10' Arm length Sidewalk width 10' Spacing (opposite) Pavement

66' 46'

45'

30' R3

ATTACHMENT G - Product Submittal Form

Lighting Context

e.g. Viaducts

Product Information Description

¹ Product Data (Summary)

**¹ Submittal
■Reference
Document**

Luminaire Designation

Luminaire Manufacturer

Luminaire Model Number

Luminous Flux - initial

lumens

Luminaire input power-initial

watts

Luminaire input power-maintained

watts

Luminaire input voltage- nominal range

volts

LED drive current - initial

milliamps

LED drive current - maintained

milliamps

CCT (correlated color temperature)

kelvin

CRI (color rendering index)

- sq. ft.
Luminaire Weight - nominal lbs.
Control Interface ANSI C136.41, 7-pin
LED Driver - dimming capability Dimmable, 0-10V Dimmable, DALI
LED driver- rated life years
Electrical transient immunity ANSI C136.2 Basic (6kV/3kA) Enhanced (10kV/5kA) Elevated (20kV/10kA)
combination wave test level
Vibration Test-ANSI C136.31 Level 2
Luminaire warranty period years
IES LM-80 test duration hours IES LM-80-15 rep

173

LED lumen maintenance at 36,000 hours % TM-21 calculator
Max. LED case temperature degrees Celsius ISTMT report

DRAWING 981

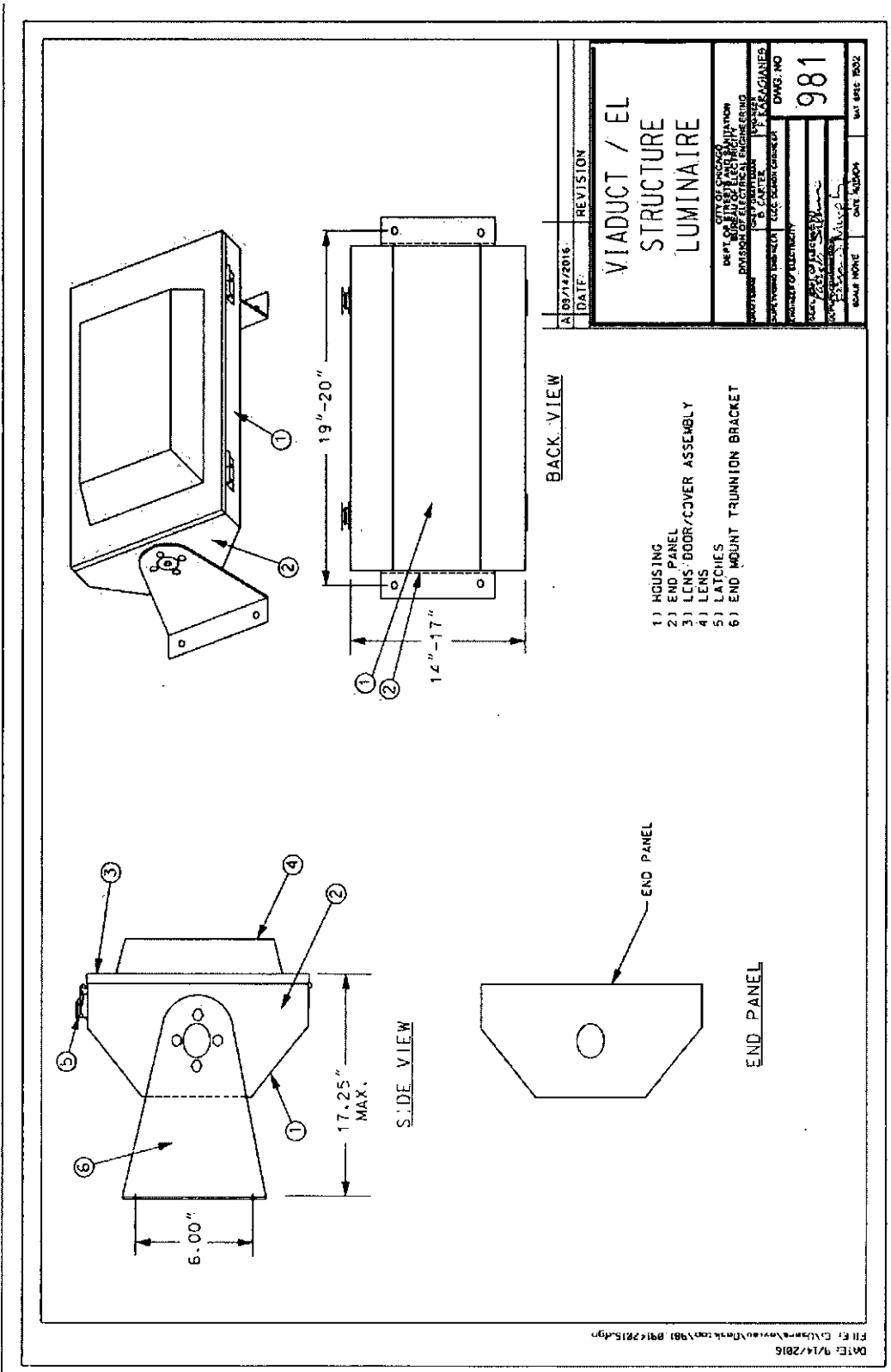

175

OUTDOOR LED LUMINAIRE SPECIFICATIONS: PARK PATHWAYS
(Cobra Head & Shoe Box Types)

SUBJECT

A. This specification states the requirements for non-ornamental Light Emitting Diode (LED) outdoor lighting luminaires. The specified LED luminaires will be used to replace existing High Pressure Sodium (HPS) and Metal Halide (MH) luminaires on Chicago Park District Park Pathways. The LED luminaires should have the capacity to be integrated into a centralized lighting management system.

GENERAL

A. References

American National Standards Institute (ANSI)

- ANSI C78.377-2015, "American National Standard for Electric Lamps-Specifications for the Chromaticity of Solid State Lighting (SSL) Products"
- ANSI C82.77-10-2014, "American National Standard for Lighting Equipment-Harmonic Emission Limits-Related Power Quality Requirements"
- ANSI C136.2-2015, "American National Standard for Roadway and Area Lighting Equipment-Dielectric Withstand and Electrical Transient Immunity Requirements"
- ANSI C136.10-2010, "American National Standard for Roadway and Area Lighting Equipment-Locking-Type Control Devices and Mating Receptacles-Physical and Electrical Interchangeability and Testing"
- ANSI C136.15-2015, "American National Standard for Roadway and Area Lighting Equipment-Luminaire Field Identification"
- ANSI C136.22-2004 (R2009, R2014), "American National Standard for Roadway and Area Lighting Equipment-Internal Labeling of Luminaires"
- ANSI C136.25-2013, "American National Standard for Roadway and Area Lighting Equipment-Ingress Protection (Resistance to Dust, Solid Objects and Moisture) for Luminaire Enclosures"
- ANSI C136.31-2015, "American National Standard for Roadway and Area Lighting Equipment-Luminaire Vibration"
- ANSI C136.37-2011, "American National Standard for Solid State Light Sources Used in Roadway and Area Lighting"
- ANSI C136.41-2013, "American National Standard for Roadway and Area Lighting Equipment-Dimming Control Between an External Locking Type Control and Ballast or Driver"

American Society for Testing and Materials (ASTM)

- ASTM B85/B85M-14, "Standard Specification for Aluminum-Alloy Die Castings"
- ASTM B117-16, "Standard Practice for Operating Salt Spray (Fog) Apparatus"
- ASTM D523-14, "Standard Test Method for Specular Gloss"
- ASTM D1654-08, "Standard Test Method for Evaluation of Painted or Coated Specimens Subjected to Corrosive Environments"
- ASTM G154-12a, "Standard Practice for Operating Fluorescent Ultraviolet (UV) Lamp Apparatus for Exposure of

176

Nonmetallic Materials"

Illuminating Engineering Society of North America (IES)

- ANSI/IES LM-63-02, "Standard File Format for Electronic Transfer of Photometric Data"
- IES LM-79-08, "Approved Method: Electrical and Photometric Measurements of Solid-State Lighting Products"
- ANSI/IES LM-80-15, "IES Approved Method: Measuring Luminous Flux and Color Maintenance of LED Packages, Arrays and Modules"
- ANSI/IES RP-8-14, "Roadway Lighting"
- IES TM-21-11 (with Addendum B), "Projecting Long Term Lumen Maintenance of LED Light Sources"

Institute of Electrical and Electronics Engineers (IEEE)

- IEEE Std 1789-2015, "IEEE Recommended Practices for Modulating Current in High-Brightness LEDs for Mitigating Health Risks to Viewers"

International Electrotechnical Commission (IEC)

- IEC 60929:2011 (with Amendment 1), "AC and/or DC-supplied electronic control gear for tubular fluorescent lamps - Performance requirements"
- IEC 60529-2004, "Degrees of Protection Provided by Enclosures (IP Code)"

Underwriters Laboratories (UL)

- ANSI/UL 1598 (3rd Edition), "Luminaires"

B. Submittal Requirements:

The Contractor must submit the following information pertaining to each specified luminaire type within fifteen (15) days of request:

1. Completed ATTACHMENT C - Submittal Form
2. Product Data Sheets.
 - a. Luminaire data sheets - including summary product description, dimensioned outline drawings, and nominal characteristics including but not limited to: initial luminous flux (lumens), input power (watts), input voltage range (volts), LED drive current (milliamps), correlated color temperature (kelvins), color rendering index, effective projected area (square feet) and weight (pounds).
 - b. LED Driver data sheet - including information described in LED Driver Requirements Section III-I-3.
 - c. LED light source data sheet
 - d. Surge protection device data sheet - if applicable
3. Photometric Performance Data
The manufacturer must provide photometric calculations, as part of each luminaire's submittal package, that demonstrate the luminaire's photometric performance will meet or exceed the photometric requirements listed in this specification. The submitted lighting calculations must include point-by-point illuminance, luminance and veiling luminance data, as well as listings of all indicated averages and ratios. Photometric reports must include the following information and be in accordance with the standards listed below:

177

IES LM-79-08 photometric report that includes measured values for initial luminous flux, input power, correlated color temperature, and color rendering index. LM-79, ISTMT, and LM-80 reports must correspond directly to submitted luminaires, and must be produced by test laboratories that satisfy the Testing Laboratory Requirements of the Design Lights Consortium (<https://www.designlights.org/content/QPL/ProductSubmit/LabTesting>).

- a. ANSI/IES LM-63-02 electronic format photometric file that corresponds to the LM-79 report.
 - b. Photometric calculations that demonstrate compliance with the illumination requirements specified herein using the LM-63 file. Calculation grids and observer locations not specified herein must be in accordance with ANSI/IES RP-8-14.
 - c. IES TM-21-11 calculation standards must be applied to photometric calculations specified herein:
 - deriving the lumen maintenance (lamp lumen depreciation) factor.ANSI/IES LM-80-15 in-situ temperature measurement testing and (ISTMT) reports containing data used in TM-21 calculations must also be submitted. TM-21 calculations must apply to the maximum LED case temperature from ISTMT, and must be submitted in the spreadsheet format of the ENERGY STAR TM-21 calculator (<https://www.energystar.gov/products/spec/luminaires> <<http://www.energystar.gov/products/spec/luminaires>> specification version 2 0 pd).
4. Safety Certification - file number indicating compliance with UL 1598. Applicable testing bodies are determined by the US Occupational

Safety Health Administration (OSHA) as Nationally Recognized Testing Laboratories (NRTL) and include: CSA (Canadian Standards Association), ETL (Edison Testing Laboratory), and UL (Underwriters Laboratory).

5. Vibration Testing - the luminaire must comply with ANSI C136.31 at Vibration Test Level 2 (3.0 G).
6. Product Samples - at least two samples of each luminaire that the contractor proposes to use must be submitted to the City. All samples must be representative production units and be supplied at no cost to the City.

C. Assembly.

Each luminaire must be delivered completely assembled, wired, and ready for installation.

D. Warranty.

The luminaire manufacturer must warrant the performance and construction of luminaires to meet the requirements of this specification, and must warrant all parts, components and appurtenances against defects due to design, workmanship or material developing within a period of ten (10) years from the date of acceptance by the City.

- The inability of a luminaire to be dimmed will constitute a luminaire failure.
- Failure of 10% or more of the LED light sources (packages or arrays/modules) in a luminaire will constitute a luminaire failure.
- The warranty must apply for application on all of the City's existing electrical systems, both grounded and ungrounded.
- During the warranty period the City may, from time to time, test a random sampling of 10-20 luminaires for verification of light output per IES LM-79 and to test dimming functionality for a given luminaire population. The percentage of luminaires not performing as required in the random sampling will be applied to the total population quantity to determine the number of new luminaire replacements that must be delivered to the City by the manufacturer, without expense to the City.

178

E. Manufacturing Experience and Capacity

The manufacturer must demonstrate at least a five year history of manufacturing LED roadway and outside area luminaires by providing a list of prior projects with project description, date, location, quantities and reference contact information. The manufacturer must also demonstrate the capacity to supply the quantities required for the contract in a timely manner.

III. CONSTRUCTION

A. Weight

The net weight of these luminaires must not be more than 30 pounds.

B. Housing.

The preferred luminaire housing material is die-cast aluminum alloy meeting ASTM Specification A380. Alternate materials may be considered. The housing must enclose the mounting hardware, LED arrays, control receptacle, terminal board, and electronic driver. The housing must include a surface to facilitate leveling with a spirit level. The housing must have integral heat sink characteristics, such that all enclosed components will operate within their designed operating temperatures under expected service conditions. No external or removable heat shields or heat sinks; are permitted. The housing must be designed to encourage water shedding. The housing must be designed to minimize dirt and bug accumulation on the optic surface.

C. Mounting Provisions.

The cobra head luminaire types must include a heavy gauge slip fitter clamping assembly suitable for secure attachment over the end of a two (2) inch 2" IP (2.375" OD) steel pipe with an approved means of clamping it firmly in mounting bracket. Shoebox luminaire types must have the necessary adjustable brackets required for mounting to a square arm. The slip fitter mounting clamp must contain an approved shield around the pipe entrance to block the entry of birds.

D. Access Door-Panel.

An access door panel allowing access to the terminal strip and LED driver must be provided. A die-cast aluminum door-panel composed of aluminum alloy A380 is preferred; alternate materials may be considered. The door-panel must be hinged to the luminaire housing and suitably latched and fastened at the closing end. It must be made to be removed easily. The hinge and fastening devices must be captive parts which will not become disengaged from the door panel.

E. Hardware.

All machine screws, locknuts, pins and set screws necessary to make a firm assembly, and for its secure attachment to the mast arm, must be furnished in place. All hardware must be of stainless steel, zinc plated steel, copper silicon alloy or other non-corrosive metal, and where necessary must be suitably plated to prevent electrolytic action by contact with dissimilar metals.

F. Finish.

The luminaire must have a polyester powder coat with a minimum 2.0 mil thickness. Surface texture and paint quality will be subject to approval. Color must be as specified in the order. A paint chip must be submitted as a sample upon request. The finish must exceed a rating of six per ASTM D1654 after 1000 hours of testing per ASTM B117. The coating must exhibit no greater than 30% reduction of gloss per ASTM D523 after 500 hours of QUV testing at ASTM G154 Cycle 6.

G. Ingress Protection.

The luminaire electric compartment housing must have an ingress protection rating of IP54 or better as described in ANSI C136.25-2013). The optical system must have a minimum rating of IP 66.

The luminaire must be listed for wet locations by a U.S. Occupational Safety Health Administration (OSHA) Nationally Recognized Laboratory (NRTL) and have a safety certification and file number indicating compliance with UL 1598.

H. General Luminaire Requirements

The luminaire must be rated to operate between -40° to +50° Celsius.

179

The luminaire must have the option of adding a house side shield. The shield should be designed to be easily installed in the field. The house side shield must be composed of a sturdy material capable of withstanding vibrations and weather conditions. The shield must cut off light trespass at approximately one mounting height behind the pole.

The luminaire must meet the requirements of ANSI C136.22 for internal labeling. A bar code with pertinent information for warranty and maintenance must be attached to the inside of the housing. A separate bar code label must be on the driver

The luminaire must be able to provide pertinent product information, for warranty and maintenance purposes, in a digital format that is compliant with the Digital Addressable Lighting Interface (DALI) protocol. This information will be transmitted through the networked Lighting Management control system.

I. Electrical Components

1. LED Optical Arrays

The LED arrays must be properly secured at the factory and must not require field adjustment for optimum photometric performance.

2. Terminal Block

- a. A terminal block of high grade molded plastic of the barrier or safety type must be mounted within the housing in a readily accessible location.
- b. Terminal block wiring; all necessary terminals, pre-wired to all luminaire components, must be provided.
- c. Terminal block terminals must have copper plated or brass plated, clamp-type pressure connectors of an approved type for "line" connections, to accommodate wire sizes from #12 to #8 A.W.G.
- d. Terminal block terminals for internal component connections must be either the screw-clamp or quick disconnect type.

3. LED Driver:

- a. Voltage. The electronic driver must operate at an input voltage range of between 120 and 277 volts, 60 Hertz. It must automatically sense the input voltage and adjust the output accordingly. The City uses nominal input voltages of 120, 208, and 240 for street lighting. When operated at any supply voltage between 80 percent and 110 percent of its rated supply voltage and at rated input frequency, a driver shall provide current and/or voltage regulation that equals or exceeds the values specified by the manufacturer.
- b. Electrical Safety. Luminaires must operate at or below the Low-Risk Level, as defined in Figure 18 of IEEE 1789-2015. This requirement must be satisfied across the dimming range.
- c. Power Factor (PF). The power factor of the driver over the design range of input voltages specified above must be in accordance to ANSI C82.77-2014. PF must be > 0.9.
- d. Total Harmonic Distortion (THD). The driver input current must have specified THD in accordance to ANSI C82.77-2014. THD must be <32%.
- e. Thermal Protection. The driver must be thermally protected to shut off when operating temperatures reach unacceptable levels.
- f. Electromagnetic Interference. Luminaire must comply with the FCC radiation emission limits for Class B digital devices given at 47 CFR 15.109.
- g. Electrical Transient Immunity.
 - Dielectric Withstand Testing - luminaire must meet the performance requirements specified in ANSI C136.2-2015 for dielectric

withstand, using the DC test level and configuration.

- Electrical Transient Immunity - luminaire must meet the performance requirements specified in ANSI C136.2-2015 for electrical transient immunity, using the Enhanced (10 kV / 5 kA) combination wave test level.
- Transient Immunity Testing Requirements
 - During electrical transient immunity testing, the device under test (DUT) must: be connected to the power source through a series coupler/decoupler network (CDN), using a two-wire (hot or hot/neutral) connection between both the power supply and CDN input and the CDN output and DUT.

181

- If AC mains is used to power the DUT, the input waveform must be characterized and documented both before and after electrical transient immunity testing, with the DUT operating at rated full output.
- For Pre-Test DUT Characterization, the diagnostic measurements shall, at a minimum, include the following: real power, input current (RMS; Root-Means-Square), power factor, and current distortion factor (THD-I Total Harmonic Distortion) when operating at rated full output.
- Manufacturer must indicate on submittal form whether failure of the electrical transient immunity system can possibly result in disconnect of power to luminaire.

- h. Dimming Capability. The driver must be capable of dimming. The dimming range must be 10% to 100% of full output. The digital lighting interface used for dimming must be DALI (Digital Addressable Lighting Interface) as per the requirements of IEC 62386. There must be a minimum of 100 dimming steps between the top and bottom of the dimming range.

Wiring.

- a. All components must be completely factory wired with non-fading, color coded leads. These leads must be insulated with an approved class of insulation and must be #16 AWG conductor at a minimum.
- b. All wires within a single circuit path must be of the same size.
- c. No wire-nut splicing will be allowed.
- d. No unnecessary splices will be allowed.
- e. Quick disconnects must be provided for all components.
- f. All wires must be properly terminated.

Control Device Receptacle and Cap.

- a. Twist-lock Receptacle for a control device that meets ANSI C136.41 must be mounted in the top of the housing with provision for proper positioning of the control device.
- b. 7-pin Receptacle. The luminaire control receptacle must be fully prewired and compliant with ANSI C136.41.
- c. 3-prong Shorting Cap that meets ANSI C136.10 must be provided.
- d. Receptacle Wire Leads must all be properly terminated.
- e. Receptacle repositioning. The receptacle must be able to be repositioned without the use of tools.
- f. Control Devices Not Included in LED Specifications. Whereas specifications for control receptacles are included, specifications for control devices are not. The control device performance requirements are part of the lighting management system specifications in the Smart Lighting

Project Technology specifications.

Component Mounting.

All electrical components must be securely mounted in such manner that individual components can be easily maintained or replaced. Permanent straps or tie-wraps will not be permitted. The entire assembly should be easily disconnected and removed for replacement.

^ 182

PHOTOMETRIC REQUIREMENTS

Light Pollution.

To limit light pollution, the submitted luminaires must not emit any light above the horizon (0 lumens at angles > 90° from nadir).

Lumen Maintenance.

- a. LED arrays must deliver a minimum of 90% of initial lumen output at 36,000 hours of operation.
- b. Light Loss Factor (LLF) < 1.0. Calculations for maintained values, i.e. $LLF = LLD \times LDD \times LATF$.
 - 1. Lamp Lumen Depreciation (LLD) Calculated at 60,000 hours as per Section II-B-3. Luminaires with less than 10,000 hours of available LM-80 test data may be submitted for consideration, but must be indicated as such.
 - 2. Luminaire Dirt Depreciation (LDD) < 0.90, and
 - 3. Luminaire Ambient Temperature Factor (LATF) < 0.96

Color Attributes

- a. Color Rendering Index (CRI) shall be no less than 65.
- b. Nominal Correlated Color Temperature (CCT) shall be 3000K as defined by ANSI C78.377 and described below:

Manufacturer-Rated Nominal CCT (K)	Allowable IES LM-79 Chromaticity (SM)	Measured Duv
3000	2870 to 3220	-0.006 to 0.006

Typical Lighting Contexts

ATTACHMENT A (below) lists the photometric performance requirements for luminaires used in municipal park pathway outdoor lighting applications: Note: The layout for municipal park pathways is found in ATTACHMENT B.

ATTACHMENT A - PHOTOMETRIC PERFORMANCE REQUIREMENTS

TYPICAL LIGHTING CONTEXT	PARK PATHWAYS
POLE CONFIGURATION*	
IES PAVEMENT CLASS	R3
PATH WIDTH	12'
AREA	-
HEIGHT TO LUMINAIRE	20'
MAST ARM LENGTH	4'
POLE SETBACK	2'
LUMINAIRE REQUIREMENTS	
Max Input Power - Default /Normal Luminance (Watts)	100
AVG. Horizontal Illuminance (fc)	>0.25
Maximum	<5
Minimum	>0.25
AVG/MIN	<4:1
MAX/MIN .	<10:1

- PATHWAY LIGHTING

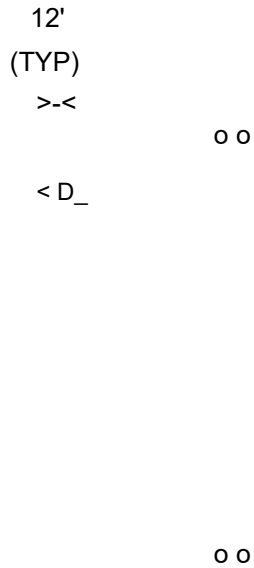

<_)
CC h-00

Q

or <

12'

o o

(TYP)

ATTACHMENT C - Product Submittal Form

<i>Lighting Context</i>	<i>e.g. Park Pathways</i>	
<i>Product Information Description</i>	<i>Product Data , * . *# . (Summary)</i>	<i>Submittal Reference Document</i>
Luminaire Designation		
Luminaire Manufacturer		
Luminaire Model Number		
Luminous Flux - initial	lumens	
Luminaire input power-initial	watts	
Luminaire input power-maintained	watts	
Luminaire input voltage- nominal range	volts	
LED drive current - initial	milliamps	
LED drive current - maintained	milliamps	
CCT (correlated color temperature)	kelvin	
CRI (color rendering index)		
EPA (effective projected area) - nominal	sq. ft.	
Luminaire Weight - nominal	lbs.	
Control Interface	<input type="checkbox"/> ANSI C136.41, 7-pin	
LED Driver - dimming capability	<input type="checkbox"/> Dimmable, 0-10V <input type="checkbox"/> Dimmable, DALI	
LED driver- rated life	years	
Electrical transient immunity ANSI C136.2 combination wave test level	<input type="checkbox"/> Basic (6kV/3kA) <input type="checkbox"/> Enhanced (10kV/5kA) <input type="checkbox"/> Elevated (20kV/10kA)	
Vibration Test-ANSI C136.31	<input type="checkbox"/> Level 2	
Luminaire warranty period	years	
186		
IES LM-80 test duration	hours	IES LM-80-15 report
LED lumen maintenance at 36,000 hours	. %	TM-21 calculator
Max. LED case temperature	degrees Celsius	ISTMT report

EXHIBIT 1A, ATTACHMENT A: PHASE 1 LED LUMINAIRE SPECIFICATIONS SUBMITTALS

[SEE ATTACHED LUMINAIRE SUBMITTALS; PARKS SUBMITTALS TBD.]

Form 4: LED Luminaire Specifications Submittal Form

Lighting Context

Residential Legacy One Sided

Product Information Description,

Product Data, v

*< . 'Submittal
Reference, ^
Document*

Luminaire Designation

Evolve LED Roadway Fixture

Luminaire Manufacturer

G.E. Lighting

Luminaire Model Number

ERL2015_30AGRAYILU

Luminaire Photo Submittal

11,000 luminaire

Luminous Flux - initial	14,690 lumens		
Luminaire input power-initial	120 watts		
Luminaire input power-maintained	130 watts		
Luminaire input voltage- nominal range	volts 120-277		
LED drive current - initial	147.5 milliamps		
LED drive current - maintained	147.5 milliamps		
CCT (correlated color temperature)	3000 kelvin		
CRI (color rendering index)	70		
EPA (effective projected area) -nominal	.5	Sq. ft	
Luminaire Weight - nominal	15.15 lbs.		
Control Interface	IHJ ANSI C136.41, 7-pin		
LED Driver - dimming capability	0 Dimmable, 0-10V	LU Dimmable, DALI	GE Drivers support both proto
LED driver- rated life	100,000 Hrs years		
Electrical transient immunity ANSI C136.2 combination wave test level	<input type="checkbox"/> Basic (6kV/3kA)	<input checked="" type="checkbox"/> LU Enhanced (10kV/5kA)	<input type="checkbox"/> Elevated (20kV/10kA)
Vibration Test-ANSI C136.31	E Level 2		
Luminaire warranty period	10 years		
IES LM-80 test duration	6000 hours		IES LM-80-15 report
LED lumen maintenance at 36,000 hours	92.13 %		TM-21 calculator
Max. LED case temperature	75 degrees Celsius		ISTMT report

Chicago Infrastructure Trust Chicago Smart Lighting
Project IUT

Form 4: LED Luminaire Specifications Submittal Form

Lighting Context	Attachment C - Alley	
Product Information-Description *	• Product Data (Summary)	Jij[^] Submittal Reference .Documentation
Luminaire Designation	Alley - New Wiring Harness.	
Luminaire Manufacturer	Leotek USA	
Luminaire Model Number	GCJ2-20H-MV-WW-2R-XX-830-DALI-PCR7-WL	Luminaire Spec Sheet
Luminous Flux - initial	5780 lumens	Luminaire Spec Sheet/LM-79
Luminaire input power-initial	54 watts	Luminaire Spec Sheet/LM-79
Luminaire input power-maintained	54 watts	Luminaire Spec Sheet/LM-79
Luminaire input voltage- nominal range	volts 120-277	Luminaire Spec Sheet/LM-79

Luminaire input voltage- nominal range	120 -277 volts	Luminaire Spec Sheet DALI Spec Sheet
LED drive current - initial	830 milliamps	Luminaire Spec Sheet/LM-79
LED drive current - maintained	830 milliamps	Luminaire Spec Sheet/LM-79
CCT (correlated color temperature)	3000 kelvin	Luminaire Spec Sheet/LM-79
CRI (color rendering index)	70 min	Luminaire Spec Sheet/LM-79
EPA (effective projected area) -nominal	.39 sq. ft.	Luminaire Spec Sheet
Luminaire Weight - nominal	7lbs.	Luminaire Spec Sheet
Control Interface	^ANSI C136.41, 7-pin	Luminaire Spec Sheet
LED Driver - dimming capability	<input type="checkbox"/> Dimmable, 0-10V <input checked="" type="checkbox"/> Dimmable, DALI	DALI Spec Sheet
LED driver- rated life	22 years	DALI Spec Sheet
Electrical transient immunity ANSI C136.2 combination wave test level	<input type="checkbox"/> Basic (6kV/3kA) <input type="checkbox"/> Enhanced (10kV/5kA) <input checked="" type="checkbox"/> S Elevated (20kV/10kA)	Luminaire Spec Sh Report
Vibration Test-ANSI C136.31	S Level 2	Luminaire Spec Sheet 3G Test Report
Luminaire warranty period	10 years	Luminaire Spec Sheet Warranty Document
IES LM-80 test duration	10,000hours	IES LM-80-15 report
LED lumen maintenance at 36,000 hours	96.8 %	TM-21 calculator
Max. LED case temperature	70.0 degrees Celsius	ISTMT report

Form 4: LED Luminaire Specifications Submittal Form

Lighting Context	e.g. Residential Acorns	
<i>Product Information Description ,</i>	Product Data (Summary) * ,	<i>Submittal Reference Document? i</i>
Luminaire Designation	Residential Acorn	
Luminaire Manufacturer	Lyonsview	Data Sheet
Luminaire Model Number	PB36LEDEB	Data Sheet
Luminous Flux - initial	3958 lumens	Data Sheet
Luminaire input power-initial	36 watts	Data Sheet
Luminaire input power-maintained	36 watts	Data Sheet
Luminaire input voltage- nominal range	120-277 volts	Data Sheet
LED drive current - initial	1050 milliamps	Data Sheet
LED drive current - maintained	1050 milliamps	Data Sheet
CCT (correlated color temperature)	3000 kelvin	Data Sheet

CCT (correlated color temperature)	3000 kelvin	Data Sheet
CRI (color rendering index)	80 CRI	Data Sheet
EPA (effective projected area) -nominal	sq. ft.	Data Sheet
Luminaire Weight - nominal	15 lbs.	Data Sheet
Control Interface	S ANSI C136.41, 7-pin	Data Sheet
LED Driver - dimming capability	<input type="checkbox"/> Dimmable, 0-10V <input type="checkbox"/> V Dimmable, DALI	Data Sheet
LED driver- rated life	100,000 years	Driver Spec
Electrical transient immunity ANSI C136.2 combination wave test level	<input type="checkbox"/> Basic (6kV/3kA) <input type="checkbox"/> Enhanced (10kV/5kA) <input type="checkbox"/> X Elevated (20kV/10kA)	36KV/18KA Data S
Vibration Test-ANSI C136.31	<input checked="" type="checkbox"/> S Level 2	Vibration Test
Luminaire warranty period	10 years	Warranty
IES LM-80 test duration	10,000 hours	IES LM-80-15 report
LED lumen maintenance at 36,000 hours	93.08- 36,000 hrs.	TM-21 calculator
Max. LED case temperature	74 degrees Celsius	ISTMT report

Form 4: LED Luminaire Specifications Submittal Form

Lighting Context

Arterial - Two Sided Staggered

Product Information Description, >:

Product Information Description, >: (j, ^v^ (Summnary)

Submittal Reference i Document

Luminaire Designation	Roadway	
Luminaire Manufacturer	Philips Lumec	
Luminaire Model Number	RFL-180W80LED3K-T-R2M	
Luminous Flux-initial	17,766 lumens	Luminaire spec sheet
Luminaire input power-initial	180 watts	Luminaire spec sheet
Luminaire input power-maintained	174 watts	Luminaire spec sheet
Luminaire input voltage- nominal range	120-277 volts	Luminaire spec sheet
LED drive current - initial	700 milliamps	Luminaire spec sheet
LED drive current - maintained	700 milliamps	Luminaire spec sheet
CCT (correlated colortemperature)	3000 kelvin	LM79 report
CRI (color renderingindex)	70 CRI	LM79 report

EPA (effective projected area)-nominal	0.92 sq.ft.	Luminaire spec sheet
Luminaire Weight - nominal	27.3 lbs.	Luminaire spec sheet
Control Interface	^ANSI C136.41, 7-pin	Luminaire spec sheet
LED Driver - dimming capability	S Dimmable, 0-10V ^Dimmable, DALI	Driver spec sheet
LED driver- rated life	100,000 years	Driver spec sheet
Electrical transient immunity ANSI C136.2 combination wave testlevel	<input type="checkbox"/> Basic (6kV/3kA) <input checked="" type="checkbox"/> Enhanced (10kV/10kA) <input type="checkbox"/> Elevated (20kV/10kA)	Surge suppressor :
Vibration Test-ANSI C136.31	svgLevel 2	3G test report
Luminaire warranty period	10 years	Warranty document
IES LM-80 testduration	10,000 hours	IES LM-80-15 report
LED lumen maintenance at 36,000 hours	97.69 %	TM-21 calculator
Max. LED case temperature	71.2 degrees Celsius	ISTMT report

Form 4: LED Luminaire Specifications Submittal Form

Lighting Context

Product Information Description
is

Modern Residential Staggered

Product Data Pdf (Summary)

Submittal Reference Document

Luminaire Designation	Roadway	
Luminaire Manufacturer	Philips Lumec	
Luminaire Model Number	RFM-108W32LED3K-T-R3M	
Luminous Flux -initial	9580 lumens	Luminaire spec sheet
Luminaire input power-initial	109 watts	Luminaire spec sheet
Luminaire input power-maintained	108 watts	Luminaire spec sheet
Luminaire input voltage- nominal range	120-277 volts	Luminaire spec sheet
LED drive current - initial	1050 milliamps	Luminaire spec sheet
LED drive current - maintained	1050 milliamps	Luminaire spec sheet
CCT (correlated colortemperature)	3000 kelvin	LM79 report
CRI (color rendering index)	70 CRI	LM79 report
EPA (effective projected area)-nominal	0.53 sq. ft.	Luminaire spec sheet
Luminaire Weight - nominal	12.2 lbs.	Luminaire spec sheet

LED lumen maintenance at 36,000 hours	92.13 %	TM-21 calculator
Max. LED case temperature	79 degrees Celsius	ISTMT report

Chicago Infrastructure Trust Chicago Smart Lighting Project KIT

CDOT Smart Lighting Form 4: LED Luminaire Specifications Submittal

Lighting Context	CDOT Viaduct and Underpass LED Luminaire	
<i>Product Information Description</i>	<i>Product Data (Summary)</i>	<i>Submittal Reference Document</i>
Luminaire Designation	Viaduct	CDOT RFP Elect. Spec #1604
Luminaire Manufacturer	Kenall Manufacturing Co.	DECLARATION OF COMPLIANCE
Luminaire Model Number	DLD1220-2-75L30K-DCC-DV-TB-10KV	LUXTRAN DLD LED DATA SHEET
Luminous Flux - initial	8,352 lumens	LM-79 IES FILE KPL1949-5.IES
Luminaire input power-initial	79.22 watts	LM-79 IES FILE KPL1949-5.IES
Luminaire input power-maintained	79.22 watts	LM-79 IES FILE KPL1949-5.IES
Luminaire input voltage- nominal range	Universal 120-277 volts	ULT LED DRIVER DATA SHEET
LED drive current - initial	525 milliamps	ULT LED DRIVER DATA SHEET
LED drive current - maintained	525 milliamps	ULT LED DRIVER DATA SHEET
CCT (correlated color temperature)	3107 kelvin	LM-79 CCT3151 REPORT
CRI (color rendering index)	81.4	LM-79 CCT3151 REPORT
EPA (effective projected area) -nominal	2.65 sq. ft.	KENALL EPA CALCULATION FOR DLD1220 LED SERIES
Luminaire Weight - nominal	20 lbs.	KENALL EPA CALCULATION FOR DLD1220 LED SERIES
Control Interface	<input type="checkbox"/> ANSI C136.41, 7-pin	NOT REQUIRED IN LUMINAIRE SUBMITTAL

Electrical transient immunity ANSI C136.2 combination wave test level	<input type="checkbox"/> Basic (6kV/3kA)	LU Enhanced (10kV/5kA)	<input type="checkbox"/> Elevated (20kV/10kA)
Vibration Test-ANSI C136.31	LU Level 2		
Luminaire warranty period	10 years		
IES LM-80 test duration	6000 hours		IES LM-80-15 report
LED lumen maintenance at 36,000 hours	%		TM-21 calculator
Max. LED case temperature	degrees Celsius		ISTMT report

Chicago Infrastructure Trust Chicago Smart Lighting Project R I P

Form 4: LED Luminaire Specifications Submittal Form

Lighting Context

Arterial Opposite

Product Information Description

***' * Product Data 'K-: (Summary)**

Submittal Reference Document

Luminaire Designation	Evolve LED Roadway Fixture		
Luminaire Manufacturer	G.E. Lighting		
Luminaire Model Number	ERLH014B330AGRAYILU		
Luminous Flux - initial	13400 lumens		
Luminaire input power-initial	122 watts		
Luminaire input power-maintained	122 watts		
Luminaire input voltage- nominal range	volts 120-277		
LED drive current - initial	milliamps		
LED drive current - maintained	milliamps		
CCT (correlated color temperature)	3000 kelvin		
CRI (color rendering index)	70		
EPA (effective projected area) -nominal	sq. ft. 0.5		
Luminaire Weight - nominal	15.15 lbs.		
Control Interface	H ANSI C136.41, 7-pin		
LED Driver - dimming capability	<input type="checkbox"/> Dimmable, 0-10V <input type="checkbox"/> S Dimmable, DALI		
LED driver- rated life	100,000 Hrs years		
Electrical transient immunity ANSI C136.2 combination wave test level	<input type="checkbox"/> Basic (6kV/3kA)	LD Enhanced (10kV/5kA)	<input type="checkbox"/> Elevated (20kV/10kA)
Vibration Test-ANSI C136.31	M Level 2		
Luminaire warranty period	10 years		
IES LM-80 test duration	6000 hours		IES LM-80-15 report
LED lumen maintenance at 36,000 hours	%		TM-21 calculator
Max. LED case temperature	degrees Celsius		ISTMT report ■

Chicago Infrastructure: Trust Chicago Smart Lighting
Project RFP

DPS Version 07/2016 - Page 1 of 2

Form 4: LED Luminaire Specifications Submittal Form

Lighting Context	e.g. Arterial Acorns <i>Product Data . . : (Summary)</i>	<i>Submittal Reference Document</i>
Luminaire Designation	Arterial Acorn	
Luminaire Manufacturer	Lyonsview	Data Sheet
Luminaire Model Number	LPBA60LEDEB	Data Sheet
Luminous Flux - initial	7012 lumens	Data Sheet
Luminaire input power-initial	61 watts	Data Sheet
Luminaire input power-maintained	61 watts	Data Sheet
Luminaire input voltage- nominal range	120-277 volts	Data Sheet
LED drive current - initial	1050 milliamps	Data Sheet
LED drive current - maintained	1050 milliamps	Data Sheet
CCT (correlated color temperature)	3000 kelvin	Data Sheet
CRI (color rendering index)	80 CRI	Data Sheet
EPA (effective projected area) -nominal	sq. ft.	Data Sheet
Luminaire Weight - nominal	15 lbs.	Data Sheet
Control Interface	■S ANSI C136.41, 7-pin	Data Sheet
LED Driver - dimming capability	<input type="checkbox"/> Dimmable, 0-10V V Dimmable, DALI	Data Sheet
LED driver- rated life	100,000 hours	Data Sheet
Electrical transient immunity ANSI C136.2 combination wave test level	<input type="checkbox"/> Basic Enhanced X Elevated (6kV/3kA) (10kV/5kA) (20kV/10kA)	36KV/18KA
Vibration Test-ANSI C136.31	■S Level 2	Vibration Test
Luminaire warranty period	10 years	Warranty Letter
IES LM-80 test duration	10,000 hours	IES LM-80-15 report
LED lumen maintenance at 36,000 hours	93.08 - 36,000 hrs.	TM-21 calculator
Max. LED case temperature	74 degrees Celsius	ISTMT report

EXHIBIT IB: LIGHTING MANAGEMENT SYSTEM FUNCTIONAL, TECHNICAL AND SERVICE REQUIREMENTS

Background

The City seeks to implement a Lighting Management System, as described in Exhibit 1 and below.

Ameresco (Contractor) responded to the CIT's CSLP Request for Proposal in which respondent Ameresco represented that its solution and services can fulfill and satisfy the City's requirements for a comprehensive lighting management system, and has set forth various representations as to its experience and ability to do so in its response dated January 9, 2017. A more detailed description of the activities, services, and technology Contractor will perform in fulfilling the City's requirements is attached hereto in Exhibit IB, Attachment 1.

As described in this Contract, including this Exhibit IB, Contractor will implement and install the Lighting Management System on behalf of the City, and provide other services in connection with the Lighting Management System, consisting of software, data migration services, installation services, implementation and consultation services, training services, hosting, warranties, and on-going maintenance and support services.

Contractor will deliver a comprehensive solution that empowers the City to perform the functions identified in Exhibit 1, Section C and that meets the requirements set forth in this Contract, including technical specifications and requirements set forth in this Exhibit IB, Attachment 2, and is consistent with the description set forth in this Exhibit IB ("the LMS").

EXHIBIT IB. ATTACHMENT 1: TECHNOLOGY SCOPE OF WORK

EXHIBIT IB, ATTACHMENT 1

Scope of Work Smart Lighting Network & Management System Implementation, Maintenance, & Support

"Contractor*" means The Contractor and/or its subcontractors. "End

Customer" or "City" means the City of Chicago.

"Enhanced Field Network Design" means a document that presents revised recommendations related to the location of access points and relays in order to meet requirements.

"Final Field Network Design" means a document that details the final locations of access points and relays in order to meet requirements and service level agreements.

"Initial Field Network Design" means a document that details the recommended locations of access points and relays in order to meet requirements.

"Integrated Devices" means SELC lighting controllers with integrated Silver Spring Networks Network Interface Cards.

"Network" means the access points, relays, and other equipment and services required to transmit data bidirectionally between luminaires or cabinets and the central lighting management system.

"Network Change" means [TBD].

"Network Equipment" means access points and relays.

Overview

This technology scope of work (SOW) will implement a networked lighting management system (LMS) that enables the City to remotely monitor and control its outdoor lighting. The following will be delivered as part of this SOW:

- 1) Implementation Services
- 2) Network Design, Installation, Maintenance and Support
- 3) Field Devices and Installation Services
- 4) Central Lighting Management Software Installation, Licensing, Maintenance and Support
- 5) System Integration Services
- 6) Training Services
- 7) Support Services

Ameresco and its subcontractors ("The Contractor") will lead the design and implementation of the citywide lighting modernization initiative, and will work with the following subcontractors to deliver the products and services identified in this SOW:

190

The system will initially support more than 240,000 individually controlled lamps and approximately 20,000 luminaires for "viaducts" that will be controlled at the circuit level. These numbers are subject to change at the City's discretion and consistent with quantities of luminaires specified in Work Orders issued pursuant to this Agreement. Notwithstanding the forgoing, the system design must be capable of supporting 350,000 Integrated Devices.

The City currently intends to authorize the Project to proceed in four phases with, approximately, one quarter of the Integrated Devices being installed in each phase. However, the details regarding, phasing, and quantities of Integrated Devices installed will not be determined or authorized until after completion of an asset condition assessment survey and will be determined by the City on a Phase-by-Phase basis pursuant to the Work Order process set forth in this Agreement. Additionally, the City may choose to add additional Integrated Devices associated with the Chicago Park District to the Project at the unit prices set forth in Exhibit 2C. In parallel with the LMS implementation will be the replacement of streetlights as part of its regular maintenance activities. After appropriate training, the City may choose to install Integrated Devices through its own means as part of that activity. Any such Integrated Devices may be in addition to, or in lieu of, Integrated Devices installed under the Project, which will be at the City's discretion.

Milestones. Silver Springs must adhere to the timeline below, which outlines the critical steps and responsibilities for implementation of the LMS. Timeframes may be adjusted (i.e. expanded or compressed) upon mutual agreement of the parties, provided that the final dates for creation of Final Field Network Design shall not be amended past [DATE]. A detailed plan tailored to the City, including Deliverables and associated deadlines, will be mutually agreed upon by The Contractor and City prior to [DATE], but completion dates will not exceed the final date for creation of Final Field Network Design set forth in this Milestones section.

The following high-level list of milestones depicts major activities for the Project:

Task	Task Description
1	Creation of Initial Field Network Design for projected full project that includes 297,000 nodes (with cellular provider data) Street Light Vision software setup begins
2	Field Survey of Poles designated for installation of an AP or Relay

- 3 Request to pole owner for AP or Relay attachment permission
- 4 Creation of Enhanced Field Network Design (will be updated for each Phase)
SLV Setup to allow APs, Relays, and Phase 1 nodes to communicate with the network is complete
- 5 AP and Relay Installation Training is provided to Subcontractor
- 6 Installation of APs and Relays begins
- 7 Installation of Streetlights and Integrated Devices begins
- 8 Admin Training for Streetlight.Vision is provided to The Contractor
- 9 End User Training for Streetlight.Vision is provided to The Contractor and End Customer
- 10 Installation of APs and Relays continues
- 11 Installation of Streetlights and Integrated Devices continues
- 12 Creation of Final Field Network Design

1) Implementation Services

To ensure that all components of this SOW are successfully planned, implemented, and managed, The Contractor will provide a Project Manager and Solution Architect to oversee the implementation and customization of the Chicago Smart Lighting Network & Management System to suit the City's business requirements. The Contractor's Project Manager will be responsible for coordinating the efforts of various subcontractors, providing a single point of contact for the City. The City shall similarly expect to provide a Project Manager who will coordinate efforts within various City departments and provide a unified voice for the ongoing business conversation with The Contractor and its subcontractors.

2) Network Design, Implementation, Maintenance and Support

The Contractor will build a robust and flexible communications network that will enable the City to remotely monitor and control its outdoor lighting. The mesh network solution will initially support over 240,000 individually-controlled lamps and approximately 20,000 viaduct luminaires at the circuit level. Notwithstanding the forgoing, the system design must be capable of supporting 350,000 Integrated Devices.

In order to achieve this, the following will be conducted by The Contractor:

a) Field Network Design Services. The Contractor will develop an initial design identifying where the Network Equipment required for the deployment area should be located. The Initial Field Network Design shall reflect the expected quantity and configuration of Network Equipment necessary to meet or exceed the Integrated Devices and Network Availability Service Level Agreements as identified in Exhibit IB, Attachment 3.

Site surveys will be conducted to validate the installation locations for Network Equipment and recommended changes, if any, to the Initial Field Network Design as noted in section 2.b of this SOW. The Contractor shall create an enhanced field network design for the deployment area identified for each phase. It is understood that the City will issue luminaire deployment maps prior to the beginning of each luminaire conversion Phase for each Project Phase, as determined by the City. For each such phase, The Contractor shall develop an Enhanced Field Network Design that shows the quantity and configuration of the network devices necessary to establish and maintain communication of all installed Network Devices as the network is being built. Network Devices that are not necessary to establish communication with the Integrated Devices contained within the deployment maps of a given phase will not be installed until such time as later deployment phase requires them. The design of

these customized plans shall include the repositioning of Network Equipment, as necessary, from one location to another to support the phasing of the Network deployment.

Following installation of all the Network Equipment, The Contractor will create a Final Field Network Design for the deployment area, which will serve as the agreed upon location for all Integrated Devices and Network Equipment, subject to the City's approval, provided that the Contractor shall have the ability to reasonably request changes to the location of its Network Equipment to optimize network performance.

c) Network Installation. Upon completion of the field network design phase, the Contractor will survey the selected locations and install the necessary APs and relays "Network Equipment." When installing the control nodes "Integrated Devices" and Network Equipment,

The network installation scope of work will consist of the following:

1. Survey each location in the Initial Field Network Design to confirm that the site conditions are adequate for mounting the APs and relays. Where field conditions are found unsuitable for mounting the hardware, alternate locations will be provided for those that require it. The

193

alternate locations will be surveyed as well to confirm field conditions are adequate. The information will be incorporated into an Enhanced Field Network Design.

2. Mount the Network APs and Relays in the locations specified by the Enhanced Field Network Design or the Final Field Network Design.
3. The APs will be Silver Spring Networks model Access Point 5.0 Cellular as noted in Exhibit IB Attachment 5. The final quantity will be determined during the detailed design phase. It is expected to be approximately 46.
4. APs will be ordered to support cellular communications with the City's designated cellular provider. Note that APs cannot be ordered until the City has selected its preferred cellular provider for this communications network.
5. The relays will be by Silver Spring Networks model Relay 5 as noted in Exhibit IB Attachment 5. The final quantity will be determined during the detailed design phase. It is expected to be approximately 5.
6. APs and Relays will be furnished with mounting hardware by Silver Spring Networks. The mounting hardware will be selected for mounting the APs and Relays on the City's light poles.
7. The APs and Relays will be mounted at a pole height consistent with the City's mounting requirements. It will be the City's obligation to furnish all necessary permits expeditiously to enable timely installation of these devices.
8. The APs and Relays will only be mounted on City owned-light poles and not on any other structures.
9. The Contractor will install a power feed to the APs and relays from a nearby street light control cabinet. New power wiring will be routed from the control cabinet, through existing conduit, and through the exiting light pole. An opening will be drilled into the pole near the mounting location of the AP/Relay to route the electric feeders to the AP/Relay.
10. The Contractor will confirm proper communication is established between the APs, relays, and the central lighting management system, StreetLight.Vision.
11. Troubleshoot using the Silver Spring Field Service Unit (FSU) where necessary.

The Contractor shall provide in-field endpoint support utilizing an Field Engineer who will: 1) validate installation and software configuration of non-communicating field-deployed endpoints, 2) perform troubleshooting of installed Access Points and Relays and 3) correct any installation errors prior to acceptance, perform troubleshooting of installed Integrated Devices. Further, The Contractor will prepare summary report of hardware/software deficiencies identified through the troubleshooting process.

The Contractor shall provide training as well as operations and maintenance manuals and cut sheets as identified in section 6 of this SOW. The Contractor will also provide the following remote field network deployment support activities:

- a) Assist with device configuration planning, including Integrated Device programs.
- b) Configure initial read schedules, exports, ping schedules and Streetlight.Vision background jobs.
- c) Train staff to create and test asset database files for import into Streetlight.Vision.
- d) Train staff to import asset database files into Streetlight.Vision.

- e) During the Initial Field Network Deployment Period, The Contractor shall train staff to perform the remote support services.
- (1) Create, test and load Access Point and Relay device files into Street Light Adapter as

these devices are deployed.

- (2) Generate and submit a summary report showing network availability
- (3) Verify that the Access Points and Relays have adequate signal strength and ensure that the software is properly configured such that the radio signals flowing to and the cellular signals flowing from the Access Points are properly processed at all times.

The Contractor will provide information about the location where Network Equipment will be/has been installed, including information about those devices that are at any time relocated or replaced after initial installation. Data will include: GPS latitude and longitude coordinates (truncated to no fewer than 5 places after the decimal point; for example, 37.466680000 is acceptable but 37.466 is not), and other material that depict the location, address (including postal code, if available), elevation above/below ground, applicable pole and asset data for each Integrated Device; full street addresses (for example, 1234 North Technology Street, Chicago, IL, 606XX (if available)); a description of the Network Equipment (for example, Access Point mounted on the traffic control pole at the North West Corner of Main St. and First Avenue); For Integrated Devices, the equipment itself will supply the GPS data; any field conditions about which End Customer is aware that may be expected to create RF or cellular interference between and among Integrated Devices; the specific placement and mounting criteria and installation techniques acceptable to the City, the Contractor, and third party stakeholders for the installation of Network Equipment on City street light poles. The Contractor shall base furnished information on Silver Spring's input and guidelines.

From time to time the Contractor may replace, upgrade, move or add Network Equipment but only to the extent reasonably required to achieve Network performance as set forth in the Premium SLA standard.

The Contractor will Identify a principal representative to coordinate the installation of any Integrated Devices and troubleshooting issues. The Contractor will purchase, install, and commission all Integrated Devices and Third Party Device Management Software, if appropriate. During the Term, the City shall, at its cost obtain the following: all approvals from third parties for all improvements, modifications, rights of way, concessions, licenses, easements or other rights necessary to:

- a) Mount, install, operate, maintain and replace any Network Equipment and provide the necessary electrical power for the Network Equipment,
- b) Enable The Contractor to develop all Field Network Designs, and
- c) Enable The Contractor to provide the Services. The City is solely responsible for all fees and expenses associated with obtaining any necessary Equipment Approvals. The Contractor shall obtain all Equipment Approvals required for installation of the Network Equipment at least two weeks prior to the scheduled date for installation if the Network Equipment and operation of the Network.

After installing the Network Equipment, The Contractor will install the Integrated Devices listed in the Enhanced Field Network Design as detailed in section 3 of this SOW. Installing Integrated Devices ahead of Network Equipment may cause additional troubleshooting effort. Notwithstanding the forgoing, the parties may agree to install Integrated Devices in advance of Network Equipment to accommodate unique City requests. The Contractor will provide specifications for attaching Network Equipment to buildings, structures, or equipment and define mounting requirements, including affixing on the install site, bolts and power tap requirements. Additionally, The Contractor will ensure that the installation of Network Equipment meets all applicable local and national requirements and regulations.

The City will provide information regarding the City's WAN provider(s) for Access Point to WAN

connectivity and the Backhaul circuit. The City will ensure that all WAN communication links are installed and maintained in accordance with The Contractors specifications. Or, appropriately authorize The Contractor to act as an agent for the City and directly communicate with and instruct WAN provider(s) on behalf of the City regarding operational issues. If reasonably

requested by The Contractor or as the Parties otherwise agree, the City will work directly with the WAN provider(s) to investigate and resolve WAN service incidents. The Contractor will coordinate field troubleshooting of installed Integrated Devices and correction of any installation errors. As well as, coordinate, as necessary during any applicable warranty period, the return merchandise authorization of Network Equipment or Integrated Devices back to their manufacturer.

d) Optimization of the Network (AP and Relay Tuning). This scope of work involves relocating an Access Point and/or Relay when it has been determined through the tuning process that the location of the device is not adequate for proper communication.

This can happen when the signals to an AP or Relay are obstructed by unexpected structures, trees, or other sources of interference. The scope of work will include the following:

1. Remove the AP or Relay from its mounting location including the mounting hardware.
2. Remove the power feed to the AP/Relay from the luminaire including the mounting straps.
3. Silver Springs shall designate an alternate location for the AP/Relay.
4. The subcontractor, the Contractor, shall conduct a field inspection of the alternate location to confirm that it is adequate for mounting an AP/Relay.
5. The AP/Relay installation scope shall repeat as described in the AP Installation scope of work.

The Contractor shall perform Network Optimization after installation of the Network Equipment and all Integrated Devices to ensure connectivity to at least ninety-nine-point-five percent (99.5.0%) of the Integrated Devices across the entire Project population. During the Optimization phase The Contractor may be selectively asked to identify an individual to schedule and coordinate Optimization-related tasks, assist in the access to sites and mounting locations, or information during Optimization. The Contractor will promptly review recommended locations for installing new or relocating existing Network Equipment and install that Network Equipment where reasonably directed.

e) Network Changes. Excluding regular maintenance on individual Integrated Devices, the City may not make any change or allow a condition to continue that (i) negatively impacts the performance of the Network or (ii) may result in a material change to Final Field Network Design without obtaining The Contractor's prior (30) days written consent, (unless circumstances exist that reasonably prevent such notice, in which case notice will be provided as soon as reasonably possible) of any proposed Network Change. The Contractor will provide a written response to the City's request within ten (10) business days. The City shall pay all costs associated with improving the performance of the Network and the updated Field Network Design after the Network Change. Where applicable, any SLA related to the Network will be suspended from the time that a Network Change is first made until Silver Spring confirms to the City that the Network has been restored to the same performance levels that existed prior to the Network Change.

f) Smart Grid Engineering Services In support of the project, The Contractor will provide a Smart Grid Engineer to perform daily monitoring, reporting, and remote troubleshooting of deployed Integrated Devices; validation testing subsequent to each system upgrade or change request; single point of contact for support of all Streetlight related issues, including ticket management, tracking, and

196

reporting; operational support for tasks such as streetlight node configuration, testing, and firmware upgrades.

g) Maintenance and Support. The Contractor will provide proactive monitoring of the health of the network including backbone (Access Points and Relays) as well as gathering and analysis of operational statistics and trends. Silver Spring will also monitor the VPN connection from the WAN backhaul to the LMS System. [TBD - ADDITIONAL LANGUAGE DEFINING RESPONSIBILITY OF NETWORK HARDWARE REPAIRS AFTER FINAL ACCEPTANCE.]

The Contractor will respond to alerts, notify City staff, track the issue, troubleshoot problems, and escalate to Silver Spring subject matter experts or third party vendors as needed. The Contractor will offer network performance guarantees, backed up by SLAs and service credits as noted in Exhibit IB, Attachment 3.

Network performance will be monitored by The Contractor's Network Operations Center (NOC). Network devices (APs/Relays) that are detected as having an adverse impact to communications are prioritized for investigation on an urgent basis; non-impacting devices (i.e., streetlights have alternate communication paths) are investigated within three business days. The Contractor will maintain a high degree of vigilance over the Chicago network with a dedicated team of professionals that manage the performance of the network, many of whom are based in Chicago's Willis Tower. Silver Spring maintains Network Operations facilities staffed 24x7 in Chicago and San Jose, California, which will have primary responsibility in ensuring the City's systems maintain all service levels.

The NOC will identify, troubleshoot and resolve any incidents to ensure the network delivers the contracted SLAs. If necessary, the NOC will escalate field maintenance issues to local The Contractor or to the City, as appropriate. When required, the NOC will perform firmware upgrades to all endpoints and/or network infrastructure to resolve issues or enable new application features. The Contractor also provides a 24x7x365 Customer Support group that manages incidents or questions raised by the City. The Contractor's NOC will work closely with the City to accomplish the following objectives: 1. Monitor the overall performance of the network with a focus on proactively identifying issues before they can cause problems 2. Ensure high network device reliability and stable mesh communication coverage 3. Analyze streetlight data to ensure consistent communications and accurate data at the meter layer of the network.

While the software system is typically not accessible or operational during a software upgrade, the field network continues to operate. Dynamic lighting, schedules, data collection, and Integrated Device operation will perform without any requirement on the CMS. Once the CMS is upgraded, the status of any actions (e.g., confirmation of a light state change) or standard data collect (e.g., metrology data) would be collected as normal, and would include all data collected while the system was "offline."

The Contractor's Network Operations Center (NOC) maintains configuration settings through various property files. During an upgrade, the configuration property files are carried forward to the new version. In the event of an error, configurations can be rolled back automatically within a SaaS environment. The Contractor currently remotely manages SLV configurations for existing customers without any security issues or concerns. In this scenario, a secure VPN tunnel is established for remote management. Worst case, a previous backup of the database can be restored to the system.

Deliverables related to this portion of the SOW include the following:

i) Initial Field Network Design.

ii) Enhanced Field Network Design, ii) Final Field Network Design.

3) Field Devices and Associated Services

The Contractor will procure, install, and commission luminaire and circuit control nodes and Access Points. In order to achieve this portion of the SOW, the following will be conducted by The Contractor:

a) Fixture and Cabinet Control Nodes ("Integrated Devices"). The Contractor will procure and work with its subcontractors to install streetlight control nodes. These devices include an external control node for individual luminaire control (or any luminaire with a 7-pin NEMA receptacle), an internal node for the decorative luminaires that do not have a NEMA receptacle. The Cabinet Controller leverages the internal controller for circuit-level on/off operation and a Smart Electric Meter for utility-grade energy monitoring, and provides the following for viaduct lighting controlled by the cabinet: 1) On-Off control through LMS scheduling 2) Utility-grade energy monitoring (Power, Energy, Volt, Current, Power Factor). 3) Alerting on luminaire circuit power failure and luminaire-on-circuit failure

e) Access Points and Relays. The Silver Spring Access Point (AP) provides two-way connectivity between street light controls, cabinet controllers, other smart city devices and the SLV6 software and integration layers. The AP is a weather-hardened router that will be mounted on street light poles. All outbound communications (requests for data) from head end software and all inbound data packets (data, alarms) pass through the AP. The AP can also pass information through multiple Silver Spring Relays

(repeaters) via sophisticated mesh network routing that ensures high reliability and redundancy. Each AP will be paired with a cellular modem housed in a NEMA enclosure. Beyond the external antennas, the Access Points do not contain Field Replaceable Units, such that faulty Access Points should be replaced with another Access Point. The Access Point will have been manufactured with the necessary configuration parameters set such that upon power on the device will automatically connect (over the cellular WAN) to the Silver Spring Networks data center.

A preliminary design of the network shows the need for approximately 46 Access Points with an additional 5 relays to assist with signal transmission from the nodes to the Access Points. However, as the network is installed, site conditions may dictate the need for additional Access Points beyond the 46. The Contractor will guarantee to the City that the communications network will include a quantity of Access Points sufficient to accommodate up to 350,000 City and Parks outdoor luminaires and that the network will meet the proposed SLA performance levels at no additional charge to the City beyond the costs for the 46 Access points and 5 relays included in EXHIBIT 2C - TECHNOLOGY/LMS COMPENSATION .

c) Field Device Installation and Commissioning. The Contractor will be responsible for installing Access Points, Relays, and Control Nodes. Installation of Access Points and Control nodes are detailed in Section 2 of this SOW. Silver Spring will provide training and remote support related to field device deployment as indicated below.

Module Commissioning. As an electrician is installing a luminaire and node, a truck operator will prepare the next luminaire and node for installation. The commissioning process for the modules (nodes) will be performed as follows:

1. Using a cellular enabled tablet running the mobile version of SLV they will locate the luminaire to be replaced on SLV map.
2. The luminaire icon will be selected on the screen to begin the commissioning process.
3. The QR codes for the new luminaire and control node will be scanned.
4. The operator will install the control node on the luminaire (via a twist lock operation).
5. The luminaire and control node will be powered up with the truck mounted power source.
6. The functionality of the fixture and control node will be confirmed via the control node self-test and the luminaire and control node will be ready for installation on the pole.

198

At the end of each day of luminaire and control node installation, the luminaires installed that day will be queried in SLV to complete the back office commissioning process. This is a batch commissioning process that is executed on a single command and may take up to 30 minutes to complete and confirm full control of the luminaire. Any luminaire that fails to communicate or indicates a fault will be flagged by SLV and will be placed on a redo list for field troubleshooting. SLV will be able to provide information to help determine the fault prior to troubleshooting deployment, such as luminaire wattage consumption, node communication, etc.

The Contractor will provide onsite training on the field commissioning process associated with the control node integrated with the streetlight fixture. The Inventory.Vision mobile app used for field commissioning. This app enables the installer to scan the bar code on a few components (i.e., Integrated Device, fixture) and can upload this information directly to the StreetLight.Vision CMS server. This solution a) reduces the amount of time to perform the installation (on average, 20 fixtures per day or 70 Integrated Devices per day) and b) increases the accuracy of the asset management data collected since it eliminates the human error component. Once the devices have been uploaded into the StreetLight.Vision CMS server, there are a number of inventory reports that can be leveraged to view device settings and attributes.

The Contractor will provide project management, training and troubleshooting support to ensure the endpoints are installed, including:

- Procurement and contracting of endpoint installers
- Project management of the endpoint deployment
- Coordination of Silver Spring delivered training for the endpoint installation contractor on installation of integrated endpoints (and optionally the field commissioning tools)
- Troubleshooting of installed endpoints and responsibility for correcting any installation errors during the Deployment

The commissioning process will include automated populating of new luminaire inventory information into the Streetlight.Vision, including manufacturer, style, part number, date of manufacture, wattage, light source, correlated color temperature, lumen output, distribution type and fixture color.

In addition, the commissioning process will include an automatic luminaire test routine, developed by The Contractor, programmed into the control node: the luminaire will turn on for 10 seconds, dim it to 50%, then turn it off to let the installer immediately know that the luminaire, driver and control node are functioning properly.

Once connected, The Contractor's NOC will complete the commissioning by performing a system validation step that confirms the aforementioned configuration parameters and activates the Access Point to participate in the mesh network providing connectivity to the endpoints.

Controller Modifications (for 24/7 Power to the Lights). The modules on the new luminaires require continuous electric power to function properly. Currently, the Integrated Devices energize the luminaire circuits at night but deenergize them during the day. The scope of work below converts the circuit from a dusk to dawn circuit to a continuous power circuit:

1. Locate the field control panel for a given circuit of luminaires.
2. Remove the existing photocell (s) at the control panel (if applicable) including all associated leads.
3. Install a copper bus and connect where the old wires connected to enable power to flow to the new luminaires.

Controller Modifications (Viaducts). The viaduct lights will be controlled at the circuit level. This means that all of the lights on an electrical circuit will turn on and off simultaneously. These lights will not be dimmable. The collective kwhr consumption of all the lights on a circuit will be measured and reported through SLV. This scope of work applies specifically to the controllers that supply electric power to the lights mounted in "viaducts". For purposes of this scope of work, viaduct lights means the lights on the roadway and walkway directly beneath railroad and roadway crossings. This scope of work excludes the following:

- lights mounted directly beneath the "L " tracks which are on the same circuit as pole mounted lights or side walk lights
- lights in tunnels such as are found in Lower Wacker Drive
- situations where the existing controller panel is not large enough to accommodate the necessary electrical devices

The control and measurement features described above will be implemented through the following scope of work:

It is understood that the wattage of the new viaduct luminaires has yet to be determined and that the quantities of new luminaires may be reduced compared to the existing. These changes to the viaduct circuits will change the electric load on the circuits. The scope of work at the controller panel for the viaduct lights is dependent on the electric load of each circuit. This is because the amperage rating of a module (a control node) is 10 amps. For example, one module (node) can support a 120V circuit with approximately 9 luminaires of 100 watts each. Therefore, the scope of work at the viaduct controller panel is as follows:

For situations where the viaduct controller has a single circuit and the load on the circuit is less than 9 amps:

1. Remove any existing photocell controller and associated wiring
2. Install a NEMA socket on the top surface of the controller panel
3. Mount a new external module on the NEMA socket
4. Rewire the circuit inside the controller such that the module is in series with the luminaires and all the electricity to the luminaires flows through the module.

For situations where the viaduct controller has more than one circuit and the load on each circuit is less than 9 amps:

5. Remove any existing photocell controller and associated wiring
6. Install NEMA sockets on the top surface of the controller panel. The quantity of NEMA sockets shall match the quantity of luminaire circuits.

5.
 7. Mount a new external module on each NEMA socket
 8. Rewire the circuit inside the controller such that each new module is in series with the luminaires and all the electricity to the luminaires flows through their corresponding module.

For situations where the viaduct controller has one circuit but the load on the circuit is greater than 9 amps, but less than 18 amps, the scope shall be executed by one of two methods. The method shall be solely at the discretion of The Contractor.

Method 1:

9. Remove any existing photocell controllers and associated wiring
10. Install a NEMA socket on the top surface of the controller panel.
11. Mount a new external module on the NEMA socket
12. Mount a new utility grade smart meter on a side surface of the controller
13. Install a new relay sized to accommodate the full amperage of the circuit.
14. Rewire the circuit inside the controller such that
 - a. The module (node) sends a signal to the new relay solenoid
 - b. The relay contacts are in series with the luminaires in the circuit and all of the electric current to the luminaires flows through the relay and not through the module (node)
 - c. The electric meter is upstream of all other devices in the circuit such that all power . flowing through the panel is measured by the meter.

Method 2:

15. Remove any existing photocell controllers and associated wiring
16. Rewire the circuit outside of the controller panel such that the circuit is divided into two (2) circuits. The circuits shall be divided such that neither circuit exceeds a load of 9 amps. This will require the installation of new wire from the controller panel to the luminaires that will form the second circuit. The wire shall either be routed through existing conduit or new conduit shall be installed or a combination thereof. This will be at the sole discretion of The Contractor.
17. Install two (2) NEMA sockets on the top surface of the controller panel.
18. Mount new external modules on each NEMA socket
19. Rewire the circuit inside the controller such that each new module is in series with its corresponding luminaires and all the electricity to the luminaires flows through their corresponding module.

For situations where the viaduct controller has one circuit but the load on the circuit is greater than 18 amps, the scope shall be executed by one of two methods. The method shall be solely at the discretion of The Contractor.

Method 1:

20. Remove any existing photocell controllers and associated wiring
21. Install a NEMA socket on the top surface of the controller panel.
22. Mount a new external module on the NEMA socket
23. Mount a new utility grade smart meter on a side surface of the controller
24. Install a new relay sized to accommodate the full amperage of the circuit.
25. Rewire the circuit inside the controller such that
 - a. The module (node) sends a signal to the new relay solenoid
 - b. The relay contacts are in series with the luminaires in the circuit and all of the electric current to the luminaires flows through the relay and not through the module (node)
 - c. The electric meter is upstream of all other devices in the circuit such that all power flowing through the panel is measured by the meter.

Method 2:

26. Remove any existing photocell controllers and associated wiring
27. Rewire the circuit outside of the controller panel such that the circuit is divided into two (2) circuits. The circuits shall be divided such that neither circuit exceeds a load of 9 amps. This will require the installation of new wire from the controller panel to the luminaires that will form the second circuit. The wire shall either be routed through existing conduit or new conduit shall be installed or a combination thereof. This will be at the sole discretion of The Contractor.
28. Install two (2) NEMA sockets on the top surface of the controller panel.
29. Mount new external modules on each NEMA socket
30. Rewire the circuit inside the controller such that each new module is in series with its corresponding luminaires and all the electricity to the luminaires flows through their corresponding module.

For situations where the viaduct controller has multiple circuits and one or more circuits that exceed 9 amps per circuit, either Method 1 or Method 2 or a combination thereof shall be implemented. The method selected shall be solely at the discretion of The Contractor.

After the Initial Field Network Deployment Period, The Contractor will assist with device configuration planning, including Integrated Device programs. This includes:

- Configure initial read schedules, exports, ping schedules and Streetlight.Vision background jobs.
- Train selected City employees to create and test asset database files for import into Streetlight.Vision.
- Train City employees to import asset database files into Streetlight.Vision.

d) Field Device Maintenance and Support. The Contractor will provide ongoing maintenance and support for the hardware and the firmware running on Streetlight Control equipment, including APs and Integrated Devices.

This maintenance includes access to firmware upgrades, patches, fixes and 24x7 Technical support via phone, email or online. Silver Spring will manage the over-the-air upgrade of firmware on Silver Spring NICs and photocells or cabinet controls. Upgrade activities, like all operational changes, will be coordinated with the City and subject to the appropriate change controls.

Hardware maintenance provides the ongoing maintenance and support for Streetlight Control Field Network equipment including APs, photocells and luminaires. Hardware Maintenance includes:

- 24x7 Technical support via phone, email or online
- Replacement of broken network equipment components via Return Material Authorization (RMA) process
- Extended warranty services

The Contractor generally schedules a weekly maintenance window of four hours. The window is not always used (or may not be used for the full window), but the timeslot is reserved in the event that Silver Spring Operations submits a change control. These windows are typically scheduled outside of critical periods (e.g., during the day to eliminate or reduce impact on on/off times). Typical uses of the

202

maintenance window include database retention, application of patches, configuration changes, and upgrades.

Firmware upgrades can be completed with limited impact to the system. The Contractor utilizes a "seed and flip" approach, where the latest firmware image is distributed to a small number of devices, who then transfer it to their neighbors in the mesh network. Once a firmware image is downloaded to the device, it can be scheduled for an upgrade, where the new image becomes the primary, while the previous image is retained for a potential rollback. The streetlight controllers are able to operate as normal except during the "flip" process, which is scheduled for a non-critical (e.g., daylight) operation.

Major firmware / software releases happen twice a year, with minor releases approximately every other month. The timing of releases is non-deterministic as Silver Spring employees a feature-based rather than time-based release cycle. The Contractor will work with the City to determine if they should take a particular release, but recommends that the City upgrade at least once a quarter to be on a

well supported release. The Contractor recommends that the reboot into new software occur during the day to minimize any impacts.

City configuration settings will be persisted in the SLV database and preserved during product upgrades. The Contractor Network Operations Center (NOC) maintains configuration settings through various property files. During an upgrade, the configuration property files are carried forward to the new version. In the event of an error, City configurations can be rolled back automatically. Silver Spring currently remotely manages SLV configurations for existing customers without any security issues or concerns. In this scenario, a secure VPN tunnel is established for remote management. Worst case, a previous backup of the database can be restored to the system.

Deliverables

i) As-built/as-constructed drawings

4) Central Lighting Management Software Licensing, Implementation, Maintenance and Support

The Contractor its subcontractors will procure, deploy, configure, test, and support and maintain the central lighting management system software, Streetlight.Vision (SLV orSLV6).

SLV6 will provide several functionalities for reporting and alerting, including:

- The Report Manager function is an-ever expanding list of pre-defined reports (currently 20+ reports) that provide periodic reports on aspects of the system's performance (e.g. electrical, failure, energy reporting). Reports are defined against the lights of interest, given a periodicity and distribution information (e.g. email or FTP). Certain reports also have configurable parameters relevant to the report.
- The Data History function allows for collection of any of the recorded data (e.g. energy) on a particular luminaire on a configurable interval. The data can be viewed graphically or saved to a CSV.
- In the Advanced Search function, ad hoc queries can be created, executed and saved on any parameter or sets of parameters on the asset inventory.
- The Alarm Manager function provides full ability to define simple or complex alarms and provide contextual responses either in email or sent out the RESTful API. The email interface can be used to send SMS messages based on accepted phone-to-email conventions used by mobile carriers.

Lighting Management System

The Contractor will implement the Silver Spring Networks' Streetlight.Vision version 6 (SLV6) as a hosted LMS.

- The system will control the designated street lights and viaduct lights either on an individual luminaire level or at a circuit level as defined elsewhere in the scope of work documents.
- SLV6 is capable of controlling and monitoring more than 60 different models of devices from 40 different vendors, making it an open platform that does not lock a customer into one proprietary system or a single manufacturer of control devices.
- Includes many features to configure, control, monitor, operate, update and manage your entire streetlight network, developed with cities during the last 10 years.

Open multi-supplier software platform

The Streetlight.Vision CMS enables command, control (ON, OFF and stepless dimming, except that viaduct lights will only have ON/OFF control at the circuit level) and monitoring of more than 60 models of devices from 40 manufacturers over 20 different types of networks, within a single web user interface. Streetlight.Vision's open data model enables control through wireless or powerline networks. Integrated Devices, control nodes, cabinet controllers, smart meters, pollution sensors, electrical vehicle charging stations, traffic controllers, etc. can all be controlled by the Streetlight.Vision Central Management Software. Unlike proprietary software designed by hardware manufacturers to control their own product, the Streetlight.Vision CMS is compatible with many different control

systems, making them all compatible within a single software, to unlock cities from proprietary vendors and to offer long term solutions.

Key Features

- Web Application Server
 - Streetlight.Vision Central Management Software based on TOMCAT web services • MySQL database engine • Automatic data retention mechanism, differentiated for each attribute, to enable longer retention of energy, lamp running hours and other long term data • Database hot backup processes • Nagios server real time monitoring processes • Java Enterprise based add-on modules
- Open software platform
 - Support 20 different technologies, 60 models of devices from 40 different manufacturers • More than 70 different services commands available to interface with your IT environment
- Web user interface
 - No thick-clients required • iPhone, iPad, Android, Windows mobile user-interfaces based on HTML5
- Automatic data collection
 - Synchronous or asynchronous data up to 500,000 devices • Automatic data aggregation for energy and lamp burning hours • Many dynamic attributes collected for each light point including light level, power, voltage, current, power factor, ambient light, lamp running hours, energy, lamp failure, ballast failure, high/low power, high/low voltage, low power factor, high temperature, etc.



- Inventory
 - Equipment Inventory to position, create, move, delete and operate various types of devices/objects with flexible lists of attributes • Supports Light Point Controllers, Streetlight Segment Controllers, Electrical Vehicle Charging Stations, Environmental Sensors, Energy Meters, Parking Place, Waste Containers and more • Export/import of inventory, reports, data • Multiple online mapping systems (WMS) including Google, Bing, Nokia and ESRI Geographical Information Servers with either map/satellite or hybrid with full zooming. • Exports for viewing in Google Earth
 - Light point controller commissioning • Segment control commissioning • Scheduler and calendar commissioning with time-based, sensor based or both • No soft-limits to the number of schedule events with unlimited ability to assign schedules to lights on a daily, weekly, monthly or quarterly occurrence. • Constant Light Output (CLO) and Maintenance factor • Over-the-air software updates

System configuration



commissioning



- User management and security:
 - User and user profile management and roll-based/access rights management to limit access to relevant WebApps, groups of devices and geographies • System allowing multiple clients to be web hosted on the same Streetlight.Vision platform • Customizable web desktop per user profile • « Look&Feel » and dictionary per user profile • Supports 16 languages including right-to-left languages • Active Directory Integration • User login screen with customized timeout
- Alarm Management
 - Real time alerts • Collect any types of failure and events detected by Light Point

Alarm management

- Real-time alerts • Collect any types of failure and events detected by Light Point Controllers and other types of devices • Complex alarm types configurable by end-user, including geographical analysis, cabinet alarms, meter alarms based on metering data analytics, non-communication alarms (e.g. wire theft detection) • Data analytics to trigger alarm conditions • Alarm viewer with alarm priority

Failure; analysis

- Failure report triggered by end-user or scheduled to be automatically sent by email • Failure analysis on map • Analysis of data history of any metered value, including power, current, voltage, temperature, ambient light, lamp level, command level/etc. , • Export any historical data and reports

Energy analysis

- Energy report triggered by the end-user or scheduled to be automatically sent by email • Energy saving estimation per geographical zone • CO2 equivalent savings estimation per geographical zone

my-mm- ,...

- Analyze lamp age and identify "old" lamps to replace them before they actually fail • Track LED luminaire warranty based on failures

m^.: Lamp age analysis

-y ^p!1 :

Reporting

- Custom and pre-defined reports scheduled to be sent to the right user at the right time (e.g. day-burners, loss of communication, out lights) • Save and rerun queries • Reports based on specified groups of lights sent to email/FTP on

specified interval.

/

Integration Components

Silver Spring Streetlight Controllers

Silver Spring Network

Integrated smart photocell with LED Luminaires using a 5 or 7-pin ANSI C136.41 Socket

Wi-Sun compliant mesh radio based on IEEE 802.15.4g, 1Watt broadcast power, 900MHz frequency-hop spread spectrum

Smart-Grid caliber security (end-to-end AES-256, X.509 certificates, secure bootloader)

Real-time power outage notification with Last Gasp

Real-time luminaire event notification

Full energy and luminaire metric tracking (Power, Energy, Volt, Current, Power Factor) with .5% accuracy at configurable intervals

Other metrics - Burn Hours, Temperature, Lux Level. Fully-weatherized units: IP-66 enclosure, -40Cto 70C, Built to long-life photocontrol standards (ANSI 136.10) Power: 120-277v

Dimming through 0-10v or DALI driver through ANSI 136.41 socket (except for Viaduct luminaires which will be ON/OFF)

Optional integrated GPS

On/Off/Dimm through on-board Integrated Device orastroclock Warranty: 10 years

Schedule based on on-board sensor, time or both Time-stamped Event logs

Autonomous behavior (i.e. smart controllers will operate and collect/retain data even if network is disconnected)

In order to achieve this portion of the SOW, the following will be conducted by The Contractor:

a) Planning and Design. The Parties will engage in informal interactive sessions that will provide and collect information relevant to educate key personnel about Silver Spring technology and practices. Sessions will be conducted via conference call or web conferencing (for example, WebEx).

b) Software Set-up. The Contractor will set up and maintain the server, database, storage and application deployment services for Streetlight.Vision at its own data centers, on a SaaS basis. The Contractor and the City

207

will have full access to Streetlight.Vision application to perform regular operations. The Contractor will host SLV at it two 7x24 Network Operations Centers and secure, redundant datacenters.

c) Streetlight.Vision Application Configuration. The Contractor will work with the City to appropriately configure and set up data hierarchy, user profiles, and administrative roles within the system.

d) Migrate Asset Data to Streetlight. Vision. As the working GIS database is being updated with corrected and verified data, data will be uploaded to SLV via batch processes. This will involve the creation of a flat file (i.e., CSV). The Contractor will transfer this file and upload the file to SLV. This process will repeat until all data has been successfully migrated to SLV. It is not the intent to have the City or others access data from the working copy of the interim GIS database. This application will be used strictly for the purpose of creating the SLV database.

e) Integration & Configuration Services. The Contractor will provide a Solution Architect for up to twenty (20) days to answer questions on Streetlight.Vision API functionality and integration approaches. These services include one onsite workshop with The Contractor and the City (as requested) for the purposes of enabling the City back office to integrate with SLV Software and communicate with the Integrated Devices.

The integrations may include: designing and implementing import file, provide support for management of Integrated Device traps, setting up new streetlight read jobs and exports, implementing Integrated Device on/off command from external applications, and collecting other data from the Integrated Device.

e) Streetlight.Vision Deployment The Contractor will provide server, database, storage and application deployment services for a single production environment of Streetlight.Vision and related Back Office network circuits and components.

f) Streetlight. Vision SaaS Services The Contractor will monitor and manage the Streetlight.Vision application for Production and Test environments. The Contractor will manage the infrastructure, apply patches and updates to the applications, and monitor availability. Silver Spring will provide for up to fifty (50) custom fields to be utilized by the City for the purposes of storing data not already defined by Streetlight.Vision. The Contractor is responsible to provide field names, data types, and data length requirements prior to deployment of Streetlight.Vision environments. Fields not provided prior to deployment may be added quarterly for the first twelve (12) months post deployment or when fifty (50) are reached."

g) Application Programming Interfaces (API) The Contractor will provide the City with access to its APIs in order to support system integrations and data extraction. Silver Spring's Streetlight.Vision platform provides a web services API base widely used XML 1.0, SOAP 1.1 and HTTPS. Streetlight.Vision web services and JMS message queues (or direct TIBCO EMS 6.1 message queues) are integrated with back-office systems. Integration options include: • Extensive web services • Industry standard Java Message Service (JMS) messaging interfaces using the TIBCO Enterprise Messaging Server 6.1. UTILITYX integration can use JMS or native TIBCO messaging client. libraries such as .Net/C#, Java, etc. • Bulk file transfers using FTP or SCP. • Email notifications using SMTP. • Time synchronization using SNTP. • Enterprise monitoring using SNMP v2 or v3.

h) Reporting. SLV provides several functionalities for reporting and alerting. The Report Manager function is an ever expanding list of pre-defined reports (currently 20+ reports) that provide periodic reports on aspects of the systems performance (e.g. electrical, failure, energy reporting). Reports are defined against the lights of interest, given a periodicity and distribution information (e.g. email or FTP). Certain reports also have configurable parameters relevant to the report.

- The Data History function allows for collection of any of the recorded data (e.g. energy) on a particular luminaire on a configurable interval. The data can be viewed graphically or saved to a CSV.

208

- In the Advanced Search function, ad hoc queries can be created, executed and saved on any parameter or sets of parameters on the asset inventory.
- The Alarm Manager function provides full ability to define simple or complex alarms and provide contextual responses either in email or sent out the RESTful API. The email interface can be used to send SMS messages based on accepted phone-to-email conventions used by mobile carriers.

The "Report Manager" WebApp enables users to create reports that are automatically computed and sent by the Streetlight.Vision CMS Web Server to selected users by email or FTP. The list of the reports available in the Streetlight.Vision CMS Web Server are included in Exhibit IB, Attachment 4.

i) System Testing. The Contractor shall perform thorough testing. Upon successful completion of the testing criteria, and the City's validation via user acceptance testing and approval thereof, acceptance testing will be complete. Testing will be conducted by The Contractor using SLV upon validation of the device deployment and confirmation of network connectivity to all devices deployed and documented with screen shots of results as appropriate, to be provided to the City periodically as requested.

Hosting Services. The Contractor shall provide hosting services, which shall cover the SLV software and any other software provided by Silver Spring to City in connection with the LMS, and shall cover all data, without limit, uploaded or entered into the LMS ("Customer Data"). In the event of a conflict between the terms set forth in this Exhibit IB, Attachment 1, and those in Exhibit 7, City Data Policy, the terms in Exhibit 7 shall control.

The Contractor represents and warrants that City may, without requiring assistance from The Contractor, extract its Customer Data, at any time, during the term of this Agreement, or subsequent to termination or expiration of the Agreement, in a non-proprietary file format compatible with commonly available commercial software and capable of use by City outside of the LMS, for no additional fees. The Contractor shall not delete or alter Customer Data, either during the term or subsequent to expiration or termination of the Agreement, without written consent of the City and subject to the terms of this Agreement.

The City's instance of SLV and any other related software will be hosted in a utility-grade facility for the deployment. With this model, security is assured through The Contractor's operation and maintenance best practices and SSAE 16 SOC 1 Type II certified datacenter. The Contractor internal security controls are based on security industry best practices derived from ISO 27002. These controls include physical and environmental security, operational security, security of third parties, system security, virus and malicious code protection, network security management, media handling, backups, monitoring, access control, vulnerability and patch management, and incident management.

An intrusion detection system monitors network traffic for suspicious activity. Servers and networks are continuously monitored by The Contractor's NOC 24x7x365 for performance issues and any unusual activities that would be indicative of a security issue. Logs are maintained for audit purposes. Suspicious activities are reported to The Contractor's InfoSEC (Information Security), who investigate

and determine if a security incident has occurred. If the suspicious activity has been identified as an incident, INFOSEC will follow a documented security incident response procedure to investigate, handle, remediate the incident, and notify customers.

Dedicated application servers are used to access customer data that is maintained in separate and secured database tables on shared database servers, leveraging shared network infrastructure at the The Contractor's data center(s). Access to the customer The Contractor's applications environment is via secure LAN-to-LAN (L2L), Business-to-Business (B2B) Virtual Private Network (VPN) using IPsec technology. Access to the application is implemented by employing SSL encryption for session privacy for The Contractor applications' web based user interface.

209

The Contractor's data center is located in a region free from most known natural disasters. The datacenter has SSAE 16 SOC 1 Type II audits to ensure protections against physical and cyber threats. Additionally, The Contractor maintains a business continuity plan (BCP) and can include Disaster Recovery (DR) plan options for customer BCP requirements.

The facility is monitored by closed circuit television (CCTV) surveillance cameras located at facility entrances. Physical access to the building and specific areas within the building is controlled, restricted, and monitored by a central proximity card access and biometric hand scan system.

The data center is designed as a secure location to protect the hardware for the infrastructure. There is no direct outside entry into the datacenters. The datacenter is located within a restricted area. Physical intrusion detection systems or alarms are in place to detect break-ins.

Physical security and access controls address system hardware, wiring used to connect elements of the system, supporting services such as electrical power or telecommunications areas, backup media, and any other elements required for the system's operations. Network Security - Logical access to any third-party networks is restricted by physical demarcation. All third-party network access requires a physical cross-connect between the customer cage and the facility's "network Point of Presence". No other third-party data networks are accessible from the customer cage. Environmental Controls - The data centers are equipped with the following environmental protection equipment: Power generators and UPS to provide power to critical servers and infrastructure devices Redundant heating ventilation and air conditioning (HVAC) systems to maintain temperatures and humidity within manufacturers' specifications Heat and smoke detection and fire suppression systems to provide for notification of fire conditions.

Data Security: The Contractor will employ the strictest security standards throughout the Streetlight solution, including ISO 27001/2 and NIST 800-53. Thanks to security mechanisms such as authentication, authorization, and encryption, Silver Spring endpoints and supporting infrastructure are capable of detecting and alerting the network management system of attempts at unauthorized actions as well as preventing security breaches. Each component within the Silver Spring Streetlight Platform can securely and uniquely identify itself to every other relevant component of the system. The architecture of the Silver Spring security system permits each component within the system to securely and uniquely identifies itself to every other relevant component of the system using a cryptographic certificate hierarchy. The identity of an entity not only includes MAC addresses, but also the role the entity plays within the system (e.g., meter, Access Point, Repeater, etc.) and who assigned them the role (e.g., manufacturer, operator/utility, field services unit). No communication within the system can occur without identity confirmations; any node can refuse to communicate with any other entity. Trust is established in stages, and authorization policies are changed to allow increasing participation in the network as a device is placed into higher trust. The Silver Spring system uses keyed-HMAC for mutual authentication between any two entities in the system - not only at the application layer but also at other layers (e.g., routing in data link layer). The common cryptographic suite for the Silver Spring system is as follows:

- Elliptic Curve Digital Signature Algorithm (ECDSA) over the NIST P-256 curve
- Advanced Encryption Standard (AES), either 128 or 256 bits
- Secure Hash Algorithm (SHA) - SHA256 variation
- Diffie-Hellman (DH) Key Agreement and Elliptic Curve Diffie-Hellman (ECDH)
- Rivest-Shamir-Adelman (RSA) Public Key Cryptography Standard (PKCS) #1 - 2048 bit signatures
- True Random Number Generator (RNG) based on a noise or entropy source, can be combined with a Pseudo-Random Number Generator (PRNG) where the RNG seeds the PRNG

The Contractor employs Internet Protocol (IP)-based security protocols over the wide area network (WAN) to ensure data integrity and measure against any number of potential security issues in managing the network.

210

These include deploying IP Security (IPsec) in transport mode between the back-office (The Contractor's applications) and the Access Point (AP)/MicroAP across the WAN. The payload of the IP packet is authenticated and encrypted in the current transport mode. The authentication algorithm used is Hash-based Message Authentication Code-Secure Hash Algorithm (HMAC-SHA1) for integrity protection and the AES Cipher Algorithm in Cipher Block Chaining (CBC) Mode with 128 bit key size for encryption (AES CBC-128).

The Contractor's solution specifically conforms to Federal Information Processing Standard (FIPS) 186-2 (for digital signatures), FIPS 197 (for encryption), FIPS 140-2 Security Level 2 and 3 (for specific hardware security modules), and FIPS PUB 198 (for cryptographic hash functions).

The back-office has standard firewalls and security compartments, and three-tier architecture with:

- Highly restricted port connectivity (access methods) between tiers
- Encrypted channels between tiers
- Encrypted channel, authentication/authorization for both UI (SSL) and programmatic APIs
- Support for customer password rotation/aging policies
- MD5 hash* of passwords at rest in database, data encrypted when archived

The connection between the SLV application and any back-office server (e.g., database) is a Transport Layer Security (TLS) or Secure Socket Layer (SSL) connection. Both ends of the connection may be authenticated - e.g., both server and clients present a digital certificate. It is recommended that the key pair used at each end to establish the TLS connection be stored in a Hardware Security Module (HSM) local to the device. This prevents insider attacks where passwords are shared. Only connections attempted with the correct client certificates will be permitted. TLS provides confidentiality, authentication and integrity protection of the connection.

The Contractor's interfaces include a WSDL API (Web Services Definition Language), a JMS (Java Message Service) API, both are available and commonly leveraged by both System Integrators and utility customers. The same web services used by The Contractor applications' User Interface are exposed to enterprise back-office systems. The complete set of WSDLs and XSDs can be downloaded through the User Interface and invoked by the enterprise middleware or other back-office application.

Logging & Audit. Trails Logging and audit trails are maintained to provide accountability for specific activities on The Contractor's hosted systems and applications. The Contractor integrates multiple data sources such as system logs, firewall and router logs, anti-virus, vulnerability management, VPN user activities, security events generated from NIDS and next generation threat prevention systems into a Security Information and Event Management (SIEM) platform. The SIEM platform provides real-time event monitoring and cross-correlation to detect and alert on critical offenses and security incidents. Further, The Contractor leverages an outside-managed SOC providing 24 x 7 security monitoring and response services. Secure Access The SLV system provides the functionality for the City of Chicago to create roles and assign privileges according to the business process policies. Application components require the proper roles and policies, enforced via digital certificates (X.509 format), to be presented to the controller to allow them to run specific operations (e.g. configure, disconnect, firmware upgrade, reads, etc.) Only the highest privilege is allowed to change policy mappings on the system. The system also enforces a role-based access for users with privileges being granted to only the appropriate user role. The Contractor's CAAS stores user credentials in either a local database or in an LDAP data store. Where CAAS is deployed with LDAP, CAAS passes authentication requests from a client application to LDAP without visibility to the user. When LDAP group users log into a THE CONTRACTOR application, the CAAS Login page appears and they are prompted to enter their LDAP group credentials to log in. If CAAS is configured

to run with an LDAP data store, CAAS sends the request for authentication to the LDAP data store. LDAP authenticates the credentials and authorizes use of views and privileges in those The Contractor's applications, to which the user or LDAP group has access.

Security Testing. The Contractor requests independent third-party companies to perform a rigorous set of penetration testing each year. The security assessment tests cover a wide spectrum of The Contractor's products, including, but not limited to, the following hardware and software: SilverLink Applications (Streetlight Vision, Advanced Metering Manager, Firmware Upgrader, Meter Program Configurator, Demand Response Manager, Network Center, and Outage Detection System); other software such as CustomerIQ, the JMS message bus, CAAS, and the DR installer portal; SilverLinkOS firmware on Communications Modules, Access Points, Relays, Bridges, and Field Service Units (FSU); and Critical Operations Protector and KeySafe. The vulnerability testing includes: • Network and application penetration testing - utilize common testing and attack methodologies to detect known vulnerabilities and attack vectors. Typical methodologies tested include denial of service, authentication/authorization deficiencies, buffer overflows, key management, injection/man-in-the-middle attacks, web services and XML content attacks. • Binary and source code analysis for firmware - Review more than one million lines of source code in the The Contractor's SilverLinkOS firmware to identify any dangerous function calls, application logic flaws, and authentication bypass vectors. • Hardware analysis and tampering attacks - Validate hardware tamper-resistance, including access to all serial ports, I/O pins and JTAG test interfaces and the ability to extract firmware.

Communication protocol analysis - Enumerate communication process and integrity of hardware messages and client-server communications, certificate management and trust relationships. Performed at least once a year, and taking three to four months to complete, the rigorous process involves four key phases:

1. Testing - The Contractor's and the third party finalize the suite of products that will be tested and agree on a test plan. Then the third-party test team performs the testing in a lab environment that includes all the necessary hardware, software, and test systems.
2. Review/Validation - Once the test team completes the testing, it generates a report containing the results and findings and reviews it with The Contractor to validate the findings.
3. Remediation/Tracking - Should any vulnerabilities emerge, The Contractor's InfoSEC team works with the appropriate product management and engineering resources to submit/track prioritized defects for remediation in future product releases.
4. Confirmation - The Contractor's engineering and QA teams perform testing to validate any resulting defect resolution.

In addition to the annual product testing described above, which benefits all our customers, The Contractor's also performs rigorous testing of the back-office infrastructure - including servers, operating system/RHEL, hypervisor/VMware - for our hosted customers. This testing includes regular review and patching of key infrastructure such as SilverLinkOS, real-time vulnerability scanning and intrusion detection, security information and event management, and a 24x7 Security Operations Center (SOC) to respond to critical events.

Information and Communications Technology Security Standards. The Contractor's complies with ISO/IEC 13335, the five-part series of standards titled Information technology - Security techniques - Management of information and communications technology security. ISO/IEC 13335 most clearly and comprehensively defines the effective security areas and controls necessary to meet most regulatory compliance and standards, including those in the NIST Guidelines for Smart Grid Cyber Security, Vol. 3, Supportive Analyses and References (NISTIR 7628).

The Contractor's Smart Energy Platform architecture and security policies reflect the best practice controls recommended in ISO/IEC 13335 and NISTIR 7628, especially in the areas of asset management (including all assets in the field), access control (at every device), and physical and environmental security (in the data centers that host the back-office servers). ISO/IEC 13335 consists of the following: ISO/IEC 13335-1 Part 1: Concepts and models for information and communications technology security management is the first in the series. ISO/IEC 13335 parts 2-5, under the general title, Information technology - Guidelines for the management of IT Security, are subtitled as follows: o ISO/IEC 13335-2: Part 2: Managing and planning IT Security o ISO/IEC 13335-3: Part 3: Techniques for the management of IT Security o ISO/IEC 13335-4: Part 4: Technical Report (TR) - Selection of safeguards o ISO/IEC TR 13335-5: Part 5: Management guidance on network security

Data Ownership: The City is the sole owner of the data on the hosted servers. Termination of

Hosted Agreement: [TO BE INSERTED]

l) Backup and Disaster Recovery. The Contractor has established formal policies and procedures to ensure that all key processes within the company have the requisite internal controls in place. This includes a business continuity plan and disaster recovery plan so that all critical operations will have appropriate redundancy, failover, and restoration capabilities. This includes geographically diverse data centers, and key resources to support the service. Hardware failure is typically covered by redundant data center infrastructure deployed to help support either full, in rack redundancy of networking and server gear, or tools for fast recovery (DataGuard, VMware etc.) Disaster Recovery (i.e. loss of a data center) of client environments is an optional component of The Contractor's standard hosting offering. When a customer buys a disaster recovery solution, the plans are exercised periodically based on the terms of the services contract. The Contractor's primary data center is hosted at Switch Communications in Las Vegas NV. The secondary data center hosting site is American Internet Services, San Diego CA.

To meet RTO and RPO requirements The Contractor offers a High Availability (HA) solution for the Silver Spring platform that is achieved using a number of replication, virtualization and business continuity tools. Because the system stores data at multiple points (in Integrated Devices, at the head end, in the MDMS, etc.), the network as a whole is designed to be resilient to individual component failure.

The server component is designed and deployed in an "Active-Passive" configuration with a warm spareserver immediately available for manual failover. The database component is designed and deployed in an "Active-Passive" configuration using Oracle DataGuard for local and remote (for Disaster Recovery) data replication and a manual failover process to activate the backup database server.

m) Software Maintenance and Support Services. The Contractor provides ongoing maintenance and support, which includes: 1) Access to application upgrades, patches, fixes 2) 24x7 Technical support via phone, email or online. Implementation (i.e., installing the software on the servers) of the upgrades, patches and bug fixes are also included during the SaaS model term as part of the ongoing operations and maintenance of the streetlight control platform.

The Contractor will provide the City with 24x7 secure access to a web-based customer portal containing The Contractor's product documentation, Updates, and other "self-service" materials, including a ticketing system will allow City users to open and track the status of issues. Knowledgeable Customer Support will be available to provide the Support Services, on weekdays (excluding holidays as The Contractor will specify annually in advance), during the hours listed. Except as required for Priority 1 Incidents contact during Customer Support

213

Business Hours may be made by telephone or email using the contact information provided in Table 1, or via a Contractor-provided ticketing system.

The Contractor generally schedules a weekly maintenance window of four hours. The window is not always used (or may not be used for the full window), but the timeslot is reserved in the event that The Contractor's Operations submits a change control. These windows are typically scheduled outside of critical periods (e.g., during the day to eliminate or reduce impact on on/off times). Typical uses of the maintenance window include database retention, application of patches, configuration changes, and upgrades.

Major firmware / software releases happen twice a year, with minor releases approximately every other month. The timing of releases is non-deterministic as The Contractor's employees a feature-based rather than time-based release cycle. The Contractor will work with the City to determine if they should take a particular release, but recommends that the City upgrade at least once a quarter to be on a wellsupported release. The Contractor recommends that the reboot into new software occur during the day to minimize any impacts.

During a software upgrade of the LMS, the system is down. Most upgrades are completed within 1 to 2 hours, though typical maintenance windows are four hours. After the upgrade, The Contractor's Operations team will complete a post-upgrade validation that confirms all functionality prior to making the system available for use by the City.

City configuration settings are persisted in the SLV database and are preserved during product upgrades. The Contractor's Network Operations Center (NOC) maintains City configuration settings through various property files. During an upgrade, the City configuration property files are carried forward to the new version. In the event of an error, configurations can be rolled back automatically within a SaaS environment. The Contractor currently remotely manages SLV configurations for existing customers without any security issues or concerns. In this scenario, a secure VPN tunnel is established for remote management. Worst case, a previous backup of the database can be restored to the system.

Deliverables

- i) ii) iii) iv)

System Configuration Document API Documentation Test Plan UAT Scripts

5) System Integration Services

This section describes the scope of work for the system integration services that The Contractor and its subcontractors shall provide. The integration scope of work does not include the design or consultation support of revised business processes associated with the implementation of the new software integral to this project or any other new software that may have an impact on this project. The scope of work includes only the investment in time necessary to understand the processes designed by the City or its consultants. Should the City seek consultative support to design new business processes around the new software that is integral to this project, The Contractor will work with its subcontractors to provide an additional proposal for such services.

a) Street Light Vision (SLV) Integration with Existing 311. The Contractor's integration subcontractor, The Contractor, will prepare a customized API software application that will act as a bridge to transfer information from the Silver Spring Networks' platform, Street Light Vision (SLV), to the City's existing 311 software system.

214

This integration script will be hosted by Amazon Web Services (AWS) and will principally leverage the following technologies:

- AWS Lambda, a computing service (using Python v2.7) that runs computer code in response to events (a change in a dataset)
- Amazon API Gateway, to facilitate API interfaces
- AWS Aurora, a fully managed database service that provides the following features:
 - o Data protection through network isolation and data encryption
 - o High availability (designed for greater than 99.99% availability)
 - o Fast recovery from instance failures (typically less than 30 seconds)
 - o Data durability through continuous backups

Specifically, the integration script will periodically (frequency to be determined) scan the SLV database to determine changes in the asset database that indicate a luminaire failure. When a new luminaire failure is detected, the script will determine the following:

- i) If an existing luminaire that has not yet been replaced by this project fails, no automation or integration services will be provided.
- ii) If a new luminaire fails within the standard 1 year Contractor's warranty period for labor and material, the integration script will open a unique type of ticket and will generate a report, and both the ticket and the report will represent that a luminaire has failed and is in the process of being repaired (and shall be repaired by Contractor). It will be The Contractor's responsibility to monitor this report and troubleshoot the issue.
- iii) If a new luminaire fails after the standard 1 year Contractor's warranty period expires, the integration script will create a new ticket in 311. It is expected that the CDOT team will access SLV to determine whether or not the luminaire is still covered by the manufacturer warranty, and to perform any other necessary checks before triaging the ticket.
- iv) When a new luminaire that was installed by this project fails and is subsequently repaired, the integration script will automatically detect from the SLV database that the luminaire has been restored to operable condition. It will then close the ticket in 311 and will note that the luminaire has been restored to an operable condition.

- v) For existing luminaires that have not been replaced by this project, there is no method by which the new lighting management system can detect the status of those lights. The management of tickets for those lights will function according to the City's current process until such time as those lights have been replaced by this project and the luminaires have been fully commissioned.

b) Integration with Future 311. All of the integration functionally established for existing 311 as described above will be replicated in future 311 as part of this scope of work. No new features will be included in future 311.

It is assumed that the future 311 system will include APIs that are materially the same as those for existing 311 from the standpoint of integrating to SLV as described in the preceding section, to be determined by the City in the City's sole discretion. Should this not be the case, The Contractor reserves the right to propose a revised scope of work with updated fees.

c) Integration with ComEd. The Contractor's integration subcontractor, The Contractor, will write a software script that will reside in the City's AWS environment, and will integrate with the SLV systems, to automatically transfer to ComEd a dataset containing information for the new luminaires as they are installed by this project, those luminaires that have been decommissioned, and any other physical changes to the lighting assets as they are performed by either the City, The Contractor or other City contractors, for example, new pole or controller

215

box locations. The dataset will be formatted as per ComEd's data transfer specifications and will contain all of the data required by the ComEd specifications including the wattage of the new luminaires.

The periodicity of the data transfer is to be determined in collaboration with the City and ComEd representatives. The intent is to automatically transfer reports as a batch process of all the changes to the lighting infrastructure as the project progresses.

It is understood that after ComEd receives the reports that identify the luminaire changes, it initiates its own process which may involve acceptance, refusal, or questioning of the submitted document. This integration scope is a one directional submission of information only as described above. Any steps requiring back and forth exchanges of information between the City and ComEd in relation to the submittal of new luminaire information is outside of this scope of work.

d) Integration with Existing GIS. SLV database will become the City's new database of record for the management of street lights and light pole assets and controller boxes. The City's existing GIS database is an expansive database that contains circuitry of the lighting system. Therefore, both systems must remain active. As such, The Contractor will integrate the SLV database with the existing GIS database by doing the following:

1. The Contractor's integrator will write a script residing within the AWS environment, that will automatically scan for changes to the datasets within SLV. The periodicity of these scans will be determined in collaboration with the City. The script will detect all the changes and will generate a "flat" file (CSV file) containing all of the datasets that have changes. The script will automatically transfer this file to an SFTP site.
2. The City's designated GIS person will then be required to log on to the SFTP site and do a manual upload of the "flat file" to the City's GIS database. As the SLV database is being built it may be necessary for the City's GIS person to upload the datasets to GIS frequently to maintain the GIS database up to date. Note that dataset changes within GIS will not transfer to SLV. It is critical that luminaire and light pole asset information be managed through SLV. For luminaires that are connected to the lighting management system, the updates will occur automatically during the luminaire commissioning process. However, for light poles and luminaires that are not part of the lighting management system, updates in SLV will have to be done manually.
3. [ADDITIONAL DESIGN SCOPE TBD.]

Deliverables

- i) **Requirements Document**
- ii) **Technical Design Document**
- iii) **API Documentation**

6) Training Services

The Contractor will provide training and knowledge transfer for each component of the Smart Lighting Project, including the new LED luminaires, the LMS, and the system integrations. For the luminaires, The Contractor and luminaire manufacturer staff will conduct familiarization training with luminaire samples at City or The Contractor's facilities, as determined by the City. As a Silver Spring reseller, The Contractor's staff has received "train the trainer" training from Silver Spring for the Silver Spring network and SLV6 CMS, and will conduct classroom style training sessions for City staff at City or The Contractor facilities, as determined by the City. These training sessions will be supplemented by detailed user manuals supplied by Silver Spring for all hardware and the SLV6 platform. The Contractor will record the training sessions for future use.

As the training sessions are held, The Contractor staff will continually evaluate the effectiveness of the training through attendee evaluations and other means. Additionally, should the City desire, The Contractor will sponsor the attendance of up to three City employees at train the trainer sessions, enabling the City to develop staff with direct expertise and training capability for SLV.

a) Application Training. As part of the SLV application training services included in [line item # 1] of Exhibit 2C,

The Contractor will provide a comprehensive training program that will include an in-depth review of all features and functionality in the Streetlight.Vision (SLV) software and field commissioning tools, as well as an overview of The Contractor's technology platform. The training is set up in a number of modules which are relevant to different end users. Certain training can be delivered as a set of web training sessions given at flexible times throughout the deployment. This hands-on course covers the configuration, use, and management of the SLV software. Subjects such as user administration, how to add devices to SLV, to configure schedules, to control devices in real-time and how to look at alarms and data generated by the system will be explained in detail. The CMS training will be provided for different user types (Administrator, Field Service Technician, 311 call center operator, etc.) so that each user type can be offered a level of training targeted to their role in an accelerated learning environment. For example, Administrator level training will include information on The Contractor's network architecture and network security; Field Service Technicians, will receive hands-on training on adding new devices to SLV and changing failed control nodes. Training will be provided on setting alert levels and notifications, scheduling options (including special lighting events), asset tracking (including procedures for synchronizing the CMS and City GIS databases to maintain data integrity as the street light inventory changes over time), reporting and analytics tools to identify and troubleshoot failures, as well as tools for tracking energy usage. The Knowledge Management module will be used during training to guide users and demonstrate the usefulness of the Silver Spring Networks online help library.

Demonstrations of all SLV6 modules will be presented in detail to perform real life manipulation of lighting controls, energy usage and savings, troubleshooting, reporting, asset management, and all other functional components of Streetlight Vision software. To ensure that the trainees have achieved the requisite level of proficiency with the SLV6 software, a customized testing platform designed specifically for designated City staff will be developed. The testing mechanism will employ hands-on as well as on-line testing via an interactive web browser. This test will be tailored to specific users based on responsibilities and their user access level. Supplemental training will be offered targeted to each trainee's areas of weakness as determined by the proficiency tests until the requisite level of proficiency is reached. The Contractor will collaborate with the City to establish the baseline for the requisite level of proficiency. All test results will be submitted to the City in a report showing test details. By applying this proficiency testing methodology, we will ensure that all users will have the knowledge to help ensure the overall success of this project.

b) Network. Access Point training will introduce the user to the network AP locations, specific installation practices like height requirements, line of sight requirements, and obstruction avoidance, focal points, coverage to determine quantity of luminaires

requirements, line or sign requirements and obstruction avoidance, total points, coverages to determine quantity of luminaires connected to each AP, and the boundaries defining the next AP network

location. Monitoring will cover the ability to detect problem zones with connectivity or coverage issues preventing proper communication between the nodes or identify nodes in need of replacement or service. Commissioning will focus on confirming acceptable coverage as well as how to gather data relevant to communication with nodes, signal strengths, and ultimately ensure proper control of street lights.

The Contractor's interface training will cover additional tools for monitoring essential components of the network as it communicates or reports the information back to the database which is ultimately processed by StreetLight.Vision CMS.

Control node training will cover installation and commissioning practices for new installations and replacement of failed control nodes on existing lights. Simulations will be created to portray a troubleshooting event that will require each trainee to assess issues and define an action plan to find solutions to specific problems.

Luminaire training will include installation, electrical wiring best practices, maintenance and cleaning procedures.

c) Field Training. The Contractor will train and support, for ten (10) business days, The Contractor, John Burns and the City on installation, troubleshooting procedures, and tools for Access Points, Relays and communication problems with Integrated Devices. Training will involve a live instructor on-site and in a classroom setting. Training will include a review of appropriate sections within existing operations manuals either printed or digital.

The Contractor will provide operations and maintenance manuals as well as cut sheets for all hardware will be provided to the City as well in electronic format. To further the impact of training, the training materials shall be provided to trainees 7 days prior to first day of training.

d) 311 Integration Training. Training for 311 integration to the LMS will include a comprehensive agenda to explain the parameters required for a seamless integration. The focus of the curriculum will be to acclimate the trainee to become an administrator of the communication portal and take ownership of security, maintenance, and troubleshooting.

e) GIS Integration Audit Training. Training will be provided to ensure that correct data is being logged and recorded before being uploaded to the new CMS database. Prospective auditors will be trained on correct GIS mapping principals and proficiency standards, reading NEMA labels, using handheld devices to record and update existing and new data to provide full scale asset tracking.

c) Proficiency Exams. All training will include a proficiency exam for each student. The proficiency exam will be designed to demonstrate that each student's competence to perform the required support services. Proficiency exams will be documented through a written or electronic exam. Training will be repeated as needed until every student achieves a passing grade in the proficiency exam.

Deliverables

- ii) iii) iv)
- v)

Operations and Maintenance Manuals Cut Sheets for all hardware Recorded Training Sessions Exams Evaluation Forms

7) Support Services

The Contractor will provide the following Services for the term of the project: Solution Services, Software Support Services or Firmware Support Services, as applicable:

a) Access to Customer Support. The Contractor will provide 24x7x365 secure access to a web-based customer portal containing The Contractor's product documentation, Updates, and other "self-service" materials, including a ticketing system that allows The Contractor or the City to open and track the status of issues. The Contractor provides a world class Support Portal to our customers, which includes Knowledge

The Contractor's Customer Support will be available to provide the Services described in this Exhibit, on weekdays (excluding holidays as The Contractor will specify annually in advance), during the hours listed below in Table 1. Except as required for Priority 1 Incidents pursuant to Table 2 below, contact during Customer Support Business Hours may be made by telephone or email using the contact information provided in Table 1, or via a Silver Spring-provided ticketing system.

The Contractor's Customer Support Team provides support on the following:

- Break-Fix issues
- Product Education
- All Core Silver Spring Applications

The Contractor has Customer Support Centers in San Jose and Melbourne (Australia) and Network Operation Centers (NOCs) in San Jose and Chicago that provide around-the-clock support coverage to our customers. Support is handled in accordance with ITIL service management processes including prioritization, response, and resolution.

The Contractor currently provides three forms of contacting technical support:

- Phone: Silver Spring has a dedicated support line; main support hours in the United States are 05:00 -18:00 Pacific Time.
- Email: The Contractor has a dedicated support e-mail alias. E-mail sent to this address automatically opens a case in Jira (The Contractor's Case Tracking Software) and sends a response e-mail to the customer containing a case number. The customer can provide more information simply by responding to this e-mail.
- Portal: The Contractor will be providing a web portal for customers where the customer can open, view, and update support cases, as well as access additional product documentation. The Portal will also provide The Contractor and the City with access to Knowledge Management, Ticket Management, Software Download and Community.

b) Incidents and Questions. The Contractor's Customer Support personnel will provide Tier 3 support, and receive and respond to Incidents and Questions. As a result of an Incident or Question being entered into the ticketing system, a new "Service Request" will be generated and referenced from that point forward. As Tier 3 support, The Contractor's Customer Support personnel will respond only to Incidents and Questions submitted by the Authorized CSR Supervisors after they have attempted to resolve problems from The Contractor's or the City's other staff. Silver Spring will use reasonable efforts to provide support within the timeframes and in the manner specified in Table 2 below. The City will cooperate with The Contractor's reasonable requests.

Requests from infrequent users of the system be directed to a Level 1 team of authorized customer support representatives or "power users." Any issues that the power users are not able to address should be escalated to The Contractor's customer support team by email, phone, or via our web portal.

The Contractor's Customer Support personnel will proactively alert the City about Priority 1 Incidents discovered in the course of its monitoring and management responsibilities under Solution Services.

c) Classification of Incidents and Questions. When the City submits an Incident or a Question, The Contractor will reasonably assess its urgency according to the appropriate Priority Levels defined in Table 2. The Contractor

219

will confirm the Priority Level and the Parties will resolve any disputes regarding the Priority Level designation as soon as is reasonably practical.

Priority Levels include:

- Level 1: Mission-critical functions in supported applications or Firmware within a production system are stopped or unavailable such that The Customer cannot reasonably continue work.
- Level 2: Major functions in supported applications or Firmware within a production system are significantly and adversely affected. The function has major and material business impact to The Customer.
- Level 3: Minor functions in supported software or Firmware are either severely degraded or inoperable and may have low business impact but do not prevent The Customer from performing regular business activity.
- Level 4: Errors with day-to-day use of the product, whether classified as user interface related, errors in documentation, presentation, or functionality that do not prevent The Customer from performing daily business.

Table 2 -Priority Levels, Response and Resolution Process* Regarding Incidents and Questions

Priority	Description	Response Time and Continuing Communication	Resolution Process*	Escalation
1	Mission-critical functions in	The Contractor Detects: The	The Contractor will	If The Contractor

<p>mission-critical functions in supported applications or Firmware within a production system are stopped or unavailable such that Customer cannot reasonably continue work.</p>	<p>The Contractor Detects: The Contractor will contact Customer by telephone within 30 minutes of initial detection, regardless of time of day. Customer Detects: Customer will contact The Contractor by telephone to report the incident. If this contact is ¹ outside of Customer Support Business Hours, The Contractor will contact Customer within 30 minutes of receipt of the Incident to acknowledge receipt of the report. Target: The Contractor will meet the stated Response times for 90% of all Priority 1 Incidents and will respond to 100% within 4 hours of receipt of the Incident. Continuing Communication: Every 2 hours after initial contact, unless the Parties otherwise agree.</p>	<p>The Contractor will investigate and work on a 24 x 7 basis to provide Customer with a root cause analysis and to: (1) resolve the Incident with a workaround; (2) implement a change to eliminate the root cause; or (3) downgrade the Priority to a P2, P3 or P4, whichever is earlier. Customer must be available 24x7 to work with The Contractor. If the root cause is found (or suspected) to be due to an Error, The Contractor will issue an Error Report and track the progress toward the completion of a change which resolves the Error, according to Table 3 below.</p>	<p>If The Contractor fails to respond within targeted response times, the Incident will be escalated as follows: After 30 minutes: Director, Front Line Support After 1 hour: Senior Director, Customer Support After 4 hours: Client Delivery Executive After 8 hours: SVP, Smart Grid Services and Operations</p>
---	---	---	--

- 1)
- 2)
- 3)
- 4)
- 5)
- 6)
- 7)
- 8)
- 9)
- 10)
- 11)
- 12)
- 13)
- 14)
- 15)
- 16)
- 221

Priority	Description	Response Time and Continuing Communication	Resolution Process* V	Escalation.
2	Major functions in	The Contractor Detects: During	The Contractor will	If The Contractor

<p>major functions in supported applications or Firmware within a production system are significantly and adversely affected. The function has major and material business impact to Customer.</p>	<p>The Contractor detects. During Customer Support Business Hours, The Contractor will contact Customer within 90 minutes of initial detection. Customer Detects: Customer will contact The Contractor to report the Incident during Customer Support Business Hours. Target: The Contractor will meet the stated Response times for 90% of all Priority 2 Incidents and will respond to 100% within 4 hours of receipt of the Incident. Continuing Communication: Every 6 hours after initial contact during Customer Support Business Hours, unless the Parties otherwise agree, unless the Parties otherwise agree.</p>	<p>The Contractor will investigate and work during Customer Support Business Hours to: (1) resolve the Incident with a workaround; (2) implement a change to eliminate the root cause; or (3) downgrade the Priority to a P3 or P4, whichever is earlier. If the root cause is found (or suspected) to be due to an Error, The Contractor will issue an Error Report and track the progress toward the completion of a change which resolves the Error, according to Table 3 below.</p>	<p>If the Contractor fails to respond within targeted response times, the Incident will be escalated as follows: After 90 minutes: Director, Front Line Support After 4 hours Senior Director, Customer Support After 8 hours: Client Delivery Executive After 24 hours: SVP, Smart Grid Services and Operations</p>
--	---	---	--

- 1)
- 2)
- 3)
- 4)
- 5)
- 6)
- 7)
- 8)
- 9)
- 10)
- 11)
- 12)
- 13)
- 14)
- 15)
- 16)
- 17)
- 18)
- 19)
- 222

Priority	Description	Response Time and Continuing Communication	Resolution Process*	Escalation
3	Minor functions in	Customer will contact The	The Contractor will	On Request

<p>minor interruptions in supported software or Firmware are either severely degraded or inoperable and may have low business impact but do not prevent Customer from performing regular business activity.</p>	<p>Customer will contact the Contractor to report the Incident during Customer Support Business Hours. The Contractor will acknowledge the Incident within 1 business day. Target: The Contractor will respond to 100% Report receipt. Continuing Communication: Weekly, unless the Parties otherwise agree.</p>	<p>The Contractor will investigate and work during Customer Support Business Hours to: (1) resolve the Incident with a workaround; (2) implement a change to eliminate the root cause; or (3) downgrade the Priority to a P4, whichever is earlier. If the root cause is found (or suspected) to be due to an Error, The Contractor will issue an Error Report and track the progress toward the completion of a change which resolves the Error, according to Table 3 below.</p>	<p>On Request</p>
<p>4 Errors with day-to-day use of the product, whether classified as user interface related, errors in documentation, presentation, or functionality that do not prevent Customer from performing daily business.</p>	<p>Customer will contact The Contractor to report the incident during Customer Support Business Hours. The Contractor will acknowledge the Incident within one business day of receipt of the Incident. Target: The Contractor will respond to 100% within one business day of receipt of the Incident. Continuing Communication: Weekly, unless the Parties otherwise agree.</p>	<p>The Contractor will investigate and work during Customer Support Business Hours to: (1) resolve the Incident with a workaround; or (2) implement a change to eliminate the root cause. If the root cause (or suspected root cause) is due to an Error, The Contractor will issue an Error Report and track the progress toward the completion of a change which resolves the Error, according to Table 3 below.</p>	<p>On Request</p>

EXHIBIT IB. ATTACHMENT 2: LMS TECHNICAL AND FUNCTIONAL REQUIREMENTS

Contractor's LMS solution must, at a minimum, meet each of the high-level technical and functional requirements described below, unless Exhibit IB, Attachment 1 contains a term that is more favorable to the City for any given requirement, in which case the more favorable term shall apply.

	Requirement	Mandatory	Description
1.1	The Lighting Management System is a software as a service solution or hosted solution.	SaaS	Software As A Service
1.2	Authentication and authorization		
1.2.1	Users must securely authenticate into the system to gain access.	YES	Full username and password with password strength requirements
1.2.2	The system supports integration with Active Directory.	Optional	VPN Server for SLV access will be LDAP-aware
1.2.3	System access levels are role-based, limiting access to change schedules or other settings within the system.	YES	Configurable user-profile that allows highlevel LMS function access as well as fine-grained action blocking.
1.2.4	A login page will identify the application and provide a means for the user to access the system.	YES	
1.2.5	If authentication is not successful, the login page is re-	YES	

1.2.5	If authentication is not successful, the Login page is re-		YES	
	displayed with appropriate messaging.			
1.2.6	The system supports session timeout at a configurable		YES	
	frequency.			
1.2.7	Users are able to log out of the system.		YES	
1.3	The Lighting Management System shall be capable		YES	
	storing asset, component, schedules, manual overrides,			
	alarm triggers, burning hours, voltages, failures,			
	maintenance, energy consumption data.			
1.4	The System will allow users to search, view, and edit		YES	
	lighting system data via a map-based interface.			
1.4.1	The system provides both street and satellite image		YES	Bing, Google supported
	basemaps.			
1.4.2	The system allows users to toggle between different		YES	
	basemaps.			
1.4.3	The system integrates with Google Street View.	Optional	YES	
1.4.4	Users can adjust zoom level.		YES	
1.4.5	Users can pan in any direction.		YES	
1.4.6	Users may zoom to a point or a group.		YES	
224				
1.4.7	The system allows users to view different point-based or		YES	Heiarchical Geozones allow
	boundary-based geographies.			for segregation of the
1.4.8	The system allows users to view Control Point locations.		YES	deployment (i.e. Wards)
				High magnification show
				individual lights. When viewing
				large geographic areas, light
				points are summarized into
				cluster icons indicating count
				in clusers.
1.4.9	The system allows users to view attributes of each Control		YES	Asset view or real-time view
	Point, including, luminaire type and/or sensor type.			
1.4.10	The system allows users to view the status of each controller		YES	Status and history of status
	(i.e., online, online reporting error, offline)			alarms
1.4.11	If applicable, the system allows users to view Gateway status		Yes	
	(i.e., online, online reporting error, offline) if applicable			
1.4.12	The system allows users to view Luminaire status (On, Off,		YES	Through realtime control
	Dimmed State, Boosted State, etc.)			
1.4.13	The system allows users to view power quality requirements		YES	Realtime control provides
	(current requirement, peak requirement).			current luminaire status with
1.4.14	The system enables users to view the peak requirement in a		YES	all monitored channels
	prescribed time period (e.g., last 24. hours).			Realtime control provides
1.4.15	The system allows users to view lighting system energy		YES	current luminaire status with
	consumption (Daily over last prescribed time period - e.g.,			all monitored channels
	Daily for last 7 days).			Realtime, historical or lifetime
1.4.16	Users may search around a radius from a point in either miles		CU	Included
	or feet. Users should be able to set distance.			
1.4.17	Users may search within a predefined boundary.		YES	Through GeoZones
1.4.18	Users may draw/define their own boundaries and search	Optional	CU	Device selection and group
	around or within that custom boundary or point: Around a			control can be achieved
	single point. In a rectangle, Within a free-form polygon, Around			through polygon but not
	and along a route			general device search
1.4.19	Users may search within more than one polygon	Optional	YES	Geozones are hiearchical allow
	simultaneously.			for multi-zone searching.
1.4.20	Users may query multiple data types at one time	Optional	YES	Advanced search allows for

1.4.20	Users may query multiple data types at one time.	Optional	YES	Advanced search allows for ad hoc query
1.4.21	Users may add one or more query filters per data type based on the schema for each data type, and using standard operators (e.g., show me all lights that are out in a particular district)		YES	Through advanced search or reports
1.4.22	Users may select and run a saved query.		YES	
1.4.23	Users may name and save queries that are run regularly.	Optional	YES	
1.4.24	Controller or sensor data elements display an information window with data elements on hover over or on click for each point.		YES	
1.4.25	Users may generate a PDF of the map and all data points with a dynamic legend.		YES	
1.5	<i>The System shall enable users to configure the following via the Graphical User Interface:</i>			
1.5.2	Users may configure the reporting frequency of online Control Point parameters for A SINGLE Control Point or groups of Control Points.		YES	
1.5.3	The Lighting Management System shall be capable of defining Luminaire groups, including "Atlas" boundaries designations provided by the city.		YES	Through Geozones
1.5.4	Users may modify the ON/OFF, DIMMED, or BOOSTED state of a single Luminaire or group of Luminaires.		Yes	
1.5.5	Users may configure and modify a predefined schedule for the ON/OFF and DIMMED or BOOSTED state of a single Luminaire or a group of Luminaires.		Yes	
1.5.6	The Lighting Management System does not limit the number of times/events per day that may be scheduled.		YES	
1.5.7	Schedules may be either time-based, whereby Controllers modify Luminaire operation when a specific time in the schedule occurs, or event-based, whereby Controllers modify Luminaire operation when the next event in the schedule occurs.		YES	
1.5.8	The Lighting Management System shall be capable of creating programs for time-based Scheduled Control that are defined: On a daily recurring basis, by specific day types, for special events, and the scheduling should allow exception days, for instance holidays.		YES	
1.5.9	Event-based Scheduled Controls are defined according to inputs from sensors or commands from the Lighting Management System.		YES	Through onboard sensors or Real-time control through the UI or RESTful API call
1.5.10	The Lighting Management System is capable of Dynamic Control, whereby the ON/OFF, DIMMED, or BOOSTED state of a single Luminaire or a group of Luminaires is modified in response to dynamic inputs from sensors or commands from the Lighting Management System.		YES	
1.5.11	The Lighting Management System is capable of Prioritized Control, whereby the Scheduled Control of individual Luminaires or groups of Luminaires is modified according to input from sensors or commands from the Lighting Management System.		YES	
1.5.12	The Lighting Management System is capable of True Input Power Control, whereby the Luminaire DIMMED or BOOSTED state is actuated to achieve to a desired true input power (percent relative watts). Please describe any Luminaire features that are required to meet this, and whether this would be done via manual or automated processes.		YES	
1.5.13	The Lighting Management System is capable of Light Output		CI	Included. Need data from

1.5.13	The Lighting Management System is capable of Light Output Control, whereby the Luminaire DIMMED or BOOSTED state is actuated to achieve a desired light output (percent relative lumens). Please describe any Luminaire features that are required to meet this, and whether this would be done via manual or automated processes.	CU	includes. Need data from luminaire vendor (light output to power curve)	1) 2) 3) 4) 5) 6) 7) 227
1.5.14	The Lighting Management System is capable of Constant Light Output Control, whereby the Luminaire DIMMED or BOOSTED state is automatically actuated to achieve a maintained constant light output (lumens) over time by compensating for Luminaire lumen depreciation. Please describe any Luminaire features that are required to meet this.	Yes	Need data from luminaire vendor (light output to power curve)	
1.5.15	The Lighting Management System can ensure that a maximum Luminaire true input power (watts) is never exceeded.	Yes		
1.6	User Administration			
1.6.1	Allows administrators to add users to the system.	YES		
1.6.2	Allows administrators to assign roles to users within the system.	YES		
1.7	Notifications and Alerts			
1.7.1	The Lighting Management System shall be capable generating outage or alert Notifications related to system components, which are specified (pre-defined and/or customized). Notifications should be automatically sent to assigned users and/or user groups via email or SMS.	YES	Alarm manager allows for complex alarm creation with support of messages that provide additional, configurable contextual information. Alarms can be sent to email, SMS or northbound API call	
1.7.2	The Lighting Management System shall be capable of detecting and reporting wire or cable theft through use of an algorithm that identifies when the following conditions exist: 1. A user-defined number of Controllers report a loss of electrical service 2. The loss of electrical service occurs within a user-defined time window 3. The Controllers are physically located consecutively along a roadway	YES	Predefined alarm type with configurable parameters.	
1.7.3	The Lighting Management System shall be capable of comparing all reported Control Point parameters with optional pre-defined maximum and minimum thresholds, and generating error messages in realtime (based on reported data availability) for any condition that violates a specified threshold a specified number (1 or more) of times.	YES		
1.8	Work Order & Asset Management			
1.8	<i>The CLMS shall interface with 311/the City's primary work order system.</i>	CU	Included 311 integration in Exhibit 2C cost	228
1.8.1	If a luminaire equipped with a control node fails, the integration script will automatically open a ticket in the 311 system.	CU	Included 311 integration in Exhibit 2C cost	
1.8.2	Intentionally deleted	CU	Included 311 integration in	

1.8.2	intentionally deleted.	CU	includes 311 integration in Exhibit 2C cost
1.8.3	The LMS shall be mobile-friendly, allowing field personnel to access information to manage their work via GPS-enabled mobile devices that include to make edits to the inventory via form and/or map interfaces.	YES	
1.8.4	When a new luminaire that was installed by this project fails and is subsequently repaired, the integration script will automatically detect from the SLV database that the luminaire has been restored to operable condition. It will then close the ticket in 311 and will note that the luminaire has been restored to an operable condition.	CU	Included 311 integration in Exhibit 2C cost
1.8.5	The LMS shall contain an asset management system that maintains information about each lighting structure and its associated features, including type, model, and wattages; installation, maintenance, removal and disposal dates, and warranty information.	YES	
1.8.6	The LMS shall contain an asset management system that maintains information about each light and its associated circuitry, controller, and power feed	YES	
1.8.7	The LMS shall enable notification, through established FTP data exchange processes, of changes to the city's lighting infrastructure that affect energy usage for billing purposes.	YES	
1.9	Reporting		
1.9.1	The Lighting Management System shall be capable of creating Remote Monitoring reports based on the generation of an error message or on a schedule.	YES	
1.9.2	The Lighting Management System shall be capable of creating pre-defined Remote Monitoring reports containing:	YES	
1.9.3	Instances of communication loss between Field Devices and the Lighting Management System	YES	
1.9.4	Control Points with error conditions, sorted by error type and/or Electrical Service Point location	YES	
1.9.5	Energy Consumption Data for individual Luminaires and/or groups of Luminaires	YES	
1.9.7	The Lighting Management System shall be capable of creating customized Remote Monitoring reports.	YES	
1.9.7.1	The Lighting Management System shall be capable of creating pre-defined asset reports.	YES	
1.9.7.2	The Lighting Management System shall be capable of creating customized asset reports.	YES	
1.9.8	Administrators or Network Operations Staff may configure the reporting frequency of online Control Point parameters for all Control Points.	YES	
1.9.9	Administrators or Network Operations Staff Network Operations Staff may configure the reporting frequency of online Control Point parameters for a single control point or groups of control points.	YES	
1.10	Application Programming Interfaces		
1.10.1	The Lighting Management System shall have an API capable of supporting integration through web services (e.g. SOAP, Restful).	YES	

1)

229

1)
2)
3)
4)
5)

1.10.2	The Lighting Management System's Scheduled Control interface should provide an interface protocol (e.g., REST, SOAP, XML) to allow third party systems to create programs for alternative schedules to be automated into the LMS Schedule Control.	YES	
1.10.3	The API supports programmatically modifying or overriding the ON/OFF, DIMMED, or BOOSTED state of a single Luminaire or group of Luminaires (i.e., when a traffic incident is reported via 911, the light levels of the lights in the surrounding area will be raised automatically).	YES	
1.10.4	The API supports getting/retrieving information about individual controllers/luminaires that may then be imported into another system or used in a program to kick-off an event in a third-party system (i.e., if a light is out, a ticket is opened in 311 via the Open311 API).	YES	
1.11	System Documentation		
1.11.1	The System shall provide users with searchable end user help documentation that provides step-by-step instructions for common tasks.	YES	
1.11.2	The System help information should be accessible from the GUI.	YES	
1.12	Interoperability and Interchangeability		
1.12.1	The Lighting Management System shall be certified as compliant with the TALQ v1.0.1 standard, and Interoperable with TALQ certified Field Devices or Field Device networks.	NA	Silver Spring Networks are founding members of the TALQ consortium and have engineered the system based on the specification. At this time, an official TALQ certification program does not exist, so no system can be TALQ certified. Silver Spring, is helping to develop this certification and will immediately certify against this once released.
1.12.2	The Lighting Management System shall be Interoperable with the Backhaul Communication Network(s).	YES	
1.12.3	The Lighting Management System shall be Interoperable with the Field Devices.	YES	
231			
1.12.4	The Lighting Management System shall be Interoperable with the Sensor(s).	YES	
1.13	Availability- As the system supports emergency response, the system must be available 24 by 7, 365 days a year with a 99.5% uptime to accommodate scheduled maintenance activities.	YES	
1.14	Capacity- The system must support 500 simultaneous users.	Yes	
1.15	Compliance with City IT and 15 Policies and Standards-	Yes	

Compliance with City IT and ICT Services and Standards
The system must comply with City of Chicago Information Technology and Security Policies.



1.16	Logging/Audit - All administrator and user operations are logged in the system and may be accessed via report.	YES	
1.17	Mobility - The application shall be usable on small glass/mobile devices.	YES	
1.18	Web Browsers Minimum Requirements - Apple Safari latest version - Google Chrome latest version - Internet Explorer latest version - Mozilla Firefox latest version	YES	
2.1	<i>The Backhaul Communication Network shall be capable of accommodating the following backhaul models. Please specify which model(s) your solution employs: 1) Node to Lighting Management Server, 2) Node to Access Point to Lighting Management Server, or 3) Hybrid Model (e.g., combination of both). **If the respondent is interested in utilizing any City-owned Fiber for backhaul, City Fiber Maps - denoting the existing location of all City-owned Fiber - can be obtained through the City's secure SFTP site.</i>	IN	LMS sends messages to the the Node through the AP. The AP is an IPv6 router that bridges the WAN to the mesh network.
2.2	<i>Backhaul Communication Network components shall be capable of normal operation over an ambient temperature range of -50 degrees C to 70 degrees C (full commercial environment).</i>	CU	Rated for -30degC. Line item of \$6k per heated NEMA4X box included as ADDER in Exhibit 2C.
			1) 2) 3)
			232
2.3	<i>Backhaul Communication Network components installed external or remote to luminaires shall be rated IEC 60529 IP67 or NEMA Type 4X.</i>	CU	Rated for -30degC. Line item of \$6k per heated NEMA4X box included as ADD in Exhibit 2C.
2.4	<i>Backhaul Communication Network components shall operate from the following (nominal ±10%) input: Universal AC input (RMS Volts) o 120-277.</i>	IN	Silver Spring AP and Relays are fully compliant. Power Input range: 96 to 277 VAC, 50 to 60 Hz.
2.5	<i>The Backhaul Communication Network shall "use an open</i>	IN	Silver Spring adheres to open

2.5	<i>The Backhaul Communication Network shall use an open, standard-based physical layer for communication such as IEEE 802.15.4.g for wireless mesh networks or 4G LTE Standards for Cellular Networks (i.e., GSM or CDMA Technologies)."</i>	IN	Silver Spring adheres to open standards and fully supports 802.15.4.g and 4G LTE.
2.6	<i>The Backhaul Communication Network shall be capable of connecting to Lighting Management Systems using open, standard-based networking technologies such as HTTPS, SMTP, SNMP, COAP, TCP, UDP or FTP.</i>	IN	Native end-to-end IPv6 network with IPv4 IPSEC tunnelling when going through public transport (i.e. cellular)
2.7	<i>All data communications over the Backhaul Communication Network (i.e., between Field Devices and the Lighting Management System) shall be secured using a standard-based security protocol (e.g., TLS, DTLS, IPsec).</i>	IN	Silver Spring secures communication over the backhaul network using Ipsec with AES-256 bit encryption.
2.8	<i>The Backhaul Communication Network shall be capable of communicating using Internet Protocol version 6 (IPv6). Every device must be addressable via an assigned IPv6 address.</i>	IN	Every end point on Silver Spring networks are IPv6 addressable and fully support the standard.
2.8	<i>The Backhaul Communication Network shall allow only authenticated and authorized access to network services by a Lighting Management System or Field Device (or Field Device Network connected through a Gateway). For example, an unauthenticated Field Device (or Field Device Network connected through a Gateway) shall not be able to use the Backhaul Communication Network to report usage or accept commands from a Lighting Management System application.</i>	IN	All Silver Spring end points use public key based authentication unique to every installation.
2.9	<i>The Backhaul Communication Network and any connected device or system shall be able to authenticate each other by a standard-based mechanism (e.g., X.509 certificates or pre-shared keys).</i>	IN	Silver Spring uses a private/public key infrastructure in order for devices to authenticate onto the network.
233			
2.1	<i>The Backhaul Communication Network and any connected device or system shall be able to authorize each other by a standard-based mechanism (e.g., X.509 certificates).</i>	IN	Silver Spring uses a private/public key infrastructure in order for devices to authenticate onto the network.
2.11	<i>The data exchange between the Backhaul Communication Network and any connected device or system shall be kept confidential using a standard-based algorithm (e.g., AES-128 or AES-256).</i>	IN	Silver Spring uses AES-256 bit encryption.
2.12	<i>The data exchange between the Backhaul Communication Network and any connected device or system shall be checked for integrity using a standard-based algorithm (e.g. keyed HMAC with SHA-256).</i>	IN	Every node establishes a symmetric key with the back-office server (application layer) and uses it to encrypt (using AES-256) or do integrity check (using keyed-HMAC) of the payload data in both directions that includes data such as configuration commands, meter usage data, security logs etc. sent back using that application.
2.13	<i>The Backhaul Communication Network shall be capable of maintaining time either on its own or by synchronizing with a remote service.</i>	IN	Silver Spring uses NTP to keep network time.
2.14	<i>The Backhaul Communication Network shall provide a detailed view of the network and its topology, including all connected Field Devices (or Field Device networks connected through a Gateway if applicable), links, and ports.</i>	IN	
2 15	<i>The Backhaul Communication Network shall provide a</i>	IN	

2.15	<i>The Backhaul Communication Network shall provide a detailed view of network performance, including available bandwidth, Field Device (or Field Device network connected through a Gateway if applicable) reachability, round-trip times, path costs, and packet delivery success/failure.</i>	IN	
2.16	<i>The Backhaul Communication Network shall provide a configuration management tool that provides the ability to view and remotely apply changes, updates, and patches to operating systems and applications on any single or a group of Backhaul Communication Network components.</i>	IN	Silver Spring back office system includes network center and firmware upgrader in order to manage end points and upgrade firmware.

234

2.17	<i>Backhaul Communication Network components shall be capable of logging time-stamped activity. The logging level shall be configurable. Any write and execute operations completed by the device shall be recorded together with the source IP address.</i>	IN	Silver Spring network components firmware offers time-stamped logging configurable logging levels which are available locally and over the backhaul network.
2.18	<i>The Backhaul Communication Network shall provide basic firewall capabilities, including filtering by port, protocol, source IP address, and destination IP address.</i>	IN	Silver Spring delivers a fully configurable packet-level application firewall rather than simple list-based packet security.
2.19	<i>The Backhaul Communication Network shall be capable of two-way communication.</i>	IN	Silver Spring endpoints support full two-way communication.
2.2	<i>The Backhaul Communication Network shall support failover to alternate routes.</i>	IN	AP back up each other and provide a self healing mesh with redundant access to network backhaul.
2.21	<i>The Backhaul Communication Network shall be capable of automatic retries during message/packet delivery attempts.</i>	IN	Backhaul communications is automatically retried when communication is lost on the backhaul cellular or Ethernet networks by the Access Points.
2.22	<i>The Backhaul Communication Network shall be capable of generating asynchronous alerts and routing both its own alerts and other devices' alerts to the Lighting Management System.</i>	IN	The Silver Spring mesh automatically transports and reroutes asynchronous alerts to the LMS and back office.
2.23	<i>The Backhaul Communication Network shall be able to prioritize the delivery of specified traffic types (e.g., high priority) over others (e.g., low priority).</i>	IN	Silver Spring Access Points and Relays support prioritization of traffic.
2.24	<i>The Backhaul Communication Network shall be capable of addressing of groups of Field Devices (or Field Device networks connected through a Gateway) for bulk messages including remote firmware upgrades and configuration changes.</i>	IN	Silver Spring back office applications organize devices in groups for management and firmware upgrades.

235

2.25	<i>The Backhaul Communication Network shall be capable of maintaining Network Availability of 98% of active and functional Field Devices (or Field Device networks connected through a Gateway) in 24 hours, 99.8% of active and functional Field Devices (or Field Device networks connected through a Gateway) in 48 hours</i>	IN	Silver Spring has designed the network availability to meet and exceed.
2.26	<i>The Backhaul Communication Network shall be capable of maintaining a round trip message time (excluding low priority traffic) of 95% within 5 seconds, 99% within 10 seconds</i>	IN	Silver Spring has designed the network availability to meet and exceed.
2.27	<i>The Backhaul Communication Network shall be capable of</i>	IN	Silver Spring has designed the

2.27	<i>The Backhaul Communication Network shall be capable of maintaining latency for individual on-demand (high priority traffic) messages of average size (up to 400 bytes) within 2 seconds or less</i>	IN	Silver Spring has designed the network availability to meet and exceed.
2.28	<i>The Backhaul Communication Network shall be capable of performing bulk firmware upgrades (as lower priority traffic) 95% in 24 hours, 100% in 4 days</i>	IN	Silver Spring has designed the network availability to meet and exceed.
2.29	<i>Interchangeability and Interoperability</i>		
2.29.1	<i>The Backhaul Communication Network shall be Interoperable with the Lighting Management System.</i>	IN	Silver Spring networks is fully interoperable with Streetlight Vision.
2:29.7	<i>The Backhaul Communication Network shall be Interoperable with the Field Devices.</i>	IN	Silver Spring has integrated our NICs in several Intelligent Photocell Controllers offering flexibility of preference and choices for networking lighting fixtures.
2.29.10	<i>The Backhaul Communication Network shall be Interoperable with the Sensor(s).</i>	IN	Many types of sensors can be connected to the network to help monitor the local environment and plan actions. Such sensors may include pollutants, which can

236

			warn citizens when levels are above recommended limits, or noise, which can help city planners make design decisions.
2.30	<i>Rated Life and Reliability</i>		
2.30.1	<i>The rated life of all Backhaul Communication Network components at an ambient temperature of 25 degrees Celsius shall be 10 years or more</i>	IN	Silver Spring product meets this rating.
2.30.2	<i>The Vendor shall report the reliability of the following Backhaul Communication Network components, as measured by Mean Time between Failures (MTBF) Gateway, Routers.</i>	IN	Silver Spring products are designed to meet the extended system life requirements of the smart grid. All components use industrial grade components that operate within wide ranges of temperatures, humidity, vibration, and other factors. Silver Spring NICs have calculated AFR (annualized failure rate based on actual field performance, MTTF calculations and accelerated life test data) of 0.13%, corresponding MTBF of 769 yrs., and an estimated useful life expectancy of 20 years; Relays and Ethernet Access Points, AFR 0.560%, MTBF 179 yrs., and 20 yrs. life expectancy; cellular Access Points, AFR 1.99%, MTBF 50 yrs., and 13.5 yrs. life expectancy.

237

The lower MTBF for the Access Point can be explained by the data provided by the modem manufacturers that drives down the overall MTBF for the Access Point. Nonetheless, from a historical perspective, changes in modem technology occur faster than equipment time to failure. Silver Spring meets this requirement

2.30.3 *The reported MTBF shall be calculated according to Telcordia SR-332.* IN

^^^^^^ *Get I&tiSR_##### -" " r i&v'l ' 2v ■ f i' ■ -v vi*

01000000-0000 - 1. 1. jxy f. .:y ■ ■. .y.y'



\$%&r:

3.1	<i>Field Devices shall be capable of normal operation over an ambient temperature range of -40 degrees C to 50 degrees C (full commercial environment).</i>	IN	
3.2	<i>Field Devices installed external or remote to luminaires shall be housed in enclosures rated shall be rated IEC 60529 IP67 or NEMA Type 4X.</i>	IN	
3.3	<i>Field Devices shall operate from the following (nominal ±10%) input: Universal AC input (RMS Volts) 120-277.</i>	IN	
3.4	<i>Provide an estimate of the peak and average power requirement of all Field Devices, and describe the methodology and assumptions used to create this estimate.</i>	Average = 2W; Peak = 5.6W	Peak is only on transmit - estimate 1% duty cycle
			1) 238
3.5	<i>Controllers shall be integrated (mechanically and electrically connected) at Control Points External to Luminaires, using a ANSI/NEMA C136.41 standard 7-terminal polarized twist-lock receptacle for both electrical and dimming control signal connectivity.</i>	IN	
3.6	<i>Controllers shall be capable of actuating the status (ON state, OFF state) of Luminaires.</i>	IN	
3.7	<i>Controllers shall be capable of actuating a Luminaire DIMMED or BOOSTED state by creating a control signal that complies with a specified DALI standard (e.g., IEC 62386).</i>	IN	
3.8	<i>Controller dimming control signal interoperability shall be verified with all Luminaires specified.</i>	IN	
3.9	<i>Actuated changes to Luminaire DIMMED or BOOSTED states by Controllers shall occur at the following rate Instantaneously, or as dictated by the Luminaire.</i>	IN	
3.10	<i>Actuated changes to Luminaire DIMMED or BOOSTED states by Controllers shall occur at the following rate over a user programmable range (% change per minute) disclosed by the Vendor.</i>	IN	
3.11	<i>Controllers shall be capable of measuring and monitoring over time the following power quality parameters: 1. RMS input voltage (Volts) 2. RMS input current (Amps) 3. Apparent power (VA) 4. True input power (Watts) 5. Power factor</i>	IN	Apparent Power not supported but can be derived from power factor
3.12	<i>Controllers shall measure power quality parameters at each Control Point for The Luminaire AND the Controller.</i>	IN	
			1) 239
3.13	<i>Controllers shall measure energy consumption with utility grade accuracy and precision ±2%.</i>	IN	SELC provides .5%
3.14	<i>Controller energy consumption accuracy shall be verified with all Luminaires specified.</i>	IN	
3.15	<i>Controllers shall be capable of interally sensina (or otherwise</i>	IN	All sensors are included

3.15	Controllers shall be capable of regularly sensing (per controller determining) and monitoring over time the following environmental parameters at minimum ambient light level (e.g., via a Photoelectric Sensor). Optionally, indicate if the following may be provided 1. Expected sunrise and sunset times (e.g., via an Astronomical Clock) 2. GPS Location 3. Temperature	IN	All sensors are included except GPS which is optional
3.16	Field Devices shall be capable of logging	IN	
3.16.1	Cumulative hours in the Luminaire ON state for each Control Point	IN	
3.16.2	Cumulative energy consumption of each Control Point	IN	
3.17	Field Devices shall log cumulative energy consumption file and send an xmlfile daily to an SFTP site with data fields specified by ComEd.	IN	xml file via SFTP come from LMS (not directly from the field device)
3.18	During Offline Operation, Field Devices shall be capable of STORING the following offline TIME-STAMPED Control Point parameters:		
			1)
			2)
			240
3.18.1	Controller status (Online, Offline, Warning or Error codes)	IN	Last Gasp provides realtime power events
3.18.2	Luminaire status (ON, OFF, Dimmed State, Boosted State, Warning or Error codes)	IN	
3.18.3	Cumulative ON state time (minutes)	IN	
3.18.4	Cumulative energy consumption (kWh)	IN	
3.19	During Offline Operation Field Devices shall be capable of STORING measurements of all offline parameters at a STORING frequency of less than once every 60 minutes.	IN	
3.20	During Offline Operation Field Devices shall be capable of STORING measurements of all offline parameters at the specified STORING frequency for a STORING period of greater than 2 days.	IN	Typically 30 days
3.21	During Online Operation, Field Devices shall be capable of REPORTING the following online Control Point parameters:		
3.21.1	Controller status (Online time. Offline time. Warning or Error codes)	IN	
			1)
			2)
			241
3.21.2	Luminaire status (ON, OFF, Dimmed State, Boosted State, Warning or Error codes)	IN	
3.21.3	Average RMS input voltage (Volts) in the ON state	IN	
3.21.4	Average RMS input current (Amps) in the ON state	IN	
3.21.5	Average true input power (Watts) in the ON state	IN	
3.21.6	Average input power factor in the ON state	IN	
3.21.7	Cumulative ON state time (minutes)	IN	
3.21.8	Cumulative energy consumption (kWh)	IN	
3.21.10	Last gasp, in the event the controller is losing power	IN	

3.21.11	<i>Optional: Ambient light level (via integral sensor)</i>	Optional	IN	Included
3.21.12	<i>Optional: LED Driver status (e.g. Warning or Error codes)</i>	Optional	IN	
3.21.13	<i>Optional: GPS location (via integral sensor)</i>	Optional	IN	Included
3.21.14	<i>Optional: Temperature (via integral sensor)</i>	Optional	IN	
3.22	<i>During Online Operation, Field Devices shall be capable of REPORTING all online Control Point parameters for ALL Control Points at a maximum Reporting Frequency of once every 24 hours.</i>		IN	Typically 6 times per day
3.23	<i>During Online Operation, Field Devices shall be capable of REPORTING all Control Point parameters for A SINGLE Control Point at a maximum Reporting Frequency of once every 60 seconds.</i>		IN	
3.24	<i>Field Devices shall execute any single command received from the Backhaul Communication Network in less than 60 seconds.</i>		IN	
3.25	<i>Field Devices shall automatically REPORT all data STORED during Offline Operation once Online Operation is restored.</i>		IN	
				1) 2) 3) 243
3.26	<i>Field Devices shall utilize a secure boot up scheme to verify the integrity of firmware images that are to be executed, thereby preventing unauthorized or maliciously modified software from running on the device.</i>		IN	Using an RSA-1024 key
3.27	<i>Field Devices shall be capable of controlling a single Luminaire or groups of Luminaires.</i>		IN	
3.28	<i>Changes in the ON/OFF, DIMMED or BOOSTED states to groups of Luminaires shall be staggered to limit the inrush current through other electrical components (e.g. contactors, relays, circuit breakers) on the Luminaire group electrical circuit.</i>		IN	
3.29	<i>Field Devices shall be capable of Manual Control, whereby the ON/OFF and DIMMED or BOOSTED state of a single Luminaire or group of Luminaires is modified in response to commands from the Lighting Management System.</i>		IN	
3.30	<i>Field Devices shall be capable of Scheduled Control, whereby the ON/OFF and DIMMED or BOOSTED state of a single Luminaire or a group of Luminaires is modified according to a predefined schedule.</i>		IN	
3.31	<i>Field Devices shall be capable of Scheduled Control that is defined for a minimum of (Instructions: enter appropriate number) times/events per day).</i>		IN Minimum =	2 (on/off)
3.32	<i>Field Devices shall be capable of Scheduled Control that is either time-based, whereby Controllers modify Luminaire operation when a specific time in the schedule occurs, or event-based, whereby Controllers modify Luminaire operation when the next event in the schedule occurs.</i>		IN	
3.33	<i>Field Devices shall be capable of time-based Scheduled Control that is defined:</i>			

			244
3.33.1	<i>On a daily recurring basis</i>	IN	
3.33.2	<i>On a weekday recurring basis</i>	IN	
3.33.3	<i>On a weekend recurring basis</i>	IN	
3.33.4	<i>For special events which occur on a daily or daily recurring basis</i>	IN	
3.34	<i>Field Devices shall be capable of event-based Scheduled Control that is defined according to inputs from integral sensors or the Lighting Management System.</i>	IN	
3.35	<i>Field Devices shall be capable of Prioritized Control, whereby the Scheduled Control of individual Luminaires or groups of Luminaires is modified or overridden according to input from integral sensors or the Lighting Management System.</i>	IN	
3.36	<i>During Offline Operation Field Devices shall be capable of maintaining Luminaire control by:</i>		
3.36.1	<i>Continuing to operate according to the most recently programmed Scheduled Control or a default Scheduled Control if one has not yet been programmed.</i>	IN	
			1) 2)
			245
3.36.2	<i>Continuing to operate according to the most recently programmed Adaptive Control or a default Adaptive Control if one has not yet been programmed, using input from an integral sensor.</i>	IN	
3.37	<i>Field Devices shall be capable of light output control, whereby the Luminaire DIMMED state is actuated to achieve a desired light output (percent relative lumens).</i>	IN	Need data from luminaire vendor (light output to power curve)
3.38	<i>Field Devices shall be capable of automatically maintaining constant Luminaire light output (lumens) over time by compensating for Luminaire lumen depreciation.</i>	IN	Need data from luminaire vendor (light output to power curve)
3.39	<i>Interchangeability and Interoperability</i>		
3.39.1	<i>Field Devices or Field Device networks shall be certified as compliant with the TALQ v1.0.1 standard, and Interoperable with TALQ certified Lighting Management Systems.</i>	NA	Silver Spring Networks are founding members of the TALQ consortium and have engineered the system based on the specification. At this time, an official TALQ certification program does not exist, so no system can be TALQ certified. Silver Spring, is helping to develop this certification and will immediately certify against this once released.
3.39.2	<i>Field Devices shall be Interoperable with the Lighting Management System.</i>	IN	
3.39.3	<i>Field Devices shall be Interoperable with the Backhaul Communication Network(s).</i>	IN	
246			
3.39.5	<i>Field Devices shall be Interoperable with the Luminaires specified.</i>	IN	
3.4	<i>Rated Life and Reliability</i>		

3.40.1	<i>The rated life of all Field Devices at an ambient temperature of 25 degrees Celsius shall be 10 years or more.</i>	IN
3.40.2	<i>The Vendor shall report the reliability of the following Field Devices, as measured by Mean Time between Failures (MTBF) Gateway, Controllers.</i>	IN
3.40.3	<i>The reported MTBF shall be calculated according to Telcordia SR-332.</i>	IN

1)
2)
3)
4)
5)
6)
7)
8)
9)
10)
11)
12)
13)
14)
15)
16)
17)
18)
19)
20)
247

EXHIBIT IB. ATTACHMENT 3: SERVICE LEVEL AGREEMENTS

See following pages.

Exhibit IB. Attachment 3
Service Level CSAs (SLAs)

21)

Network Availability. Premium SLA is included which means that the Network will connect to at least ninety-nine-point-five percent (99.5%) of Integrated Devices at least once per Day. Silver Spring will issue a Service Level Credit specified in Table 1 based on the number of Days in a calendar month that one percent (1%) (or more) of the Optimized Integrated Devices cannot communicate with the Network at least once during an entire Day. Notwithstanding this 99.5% SLA, Ameresco represents and warrants, consistent with the representations made in its proposal and included in this Agreement in Exhibit IB, Attachment 1, that the Network shall be capable of 99.9% availability.

No. of Days in the applicable calendar month where the Network Availability is not met	Service Level Credit (% of Quarterly SaaS Fees)
1-3	0%
4-6	5%
7-10	10%
11-14	15%
15 or more	20%

Streetlight Vision Availability. Streetlight Vision will be available and accessible by Ameresco and the End Customer, and functioning normally, at least ninety-nine-point-five percent (99.5%) of the time via web login. A determination of availability will be based on 24x7 accessibility (excluding time for preventive maintenance). City will be entitled to Service Level Credits for Silver Spring's failure to meet the foregoing target for the production environment only according to Table 3.

V Streetlight Vision Availability SLA

Quarterly Availability Performance	• Service Level Credit (% of Quarterly SaaS Fees)
>97 and <98.5%	3%
>95% and < 97%	10%
<95.0%	20%

EXHIBIT IB. ATTACHMENT 4: REPORTS

See following pages.

The LMS application (SLV) includes the following applications which enable the end user (staff level) to generate reports, alarms and export data:

- The "Report Manager" WebApp enables users to create reports that are automatically computed and sent by the Streetlight.Vision CMS Web Server to selected users by email or FTP. Below is the list of the reports available in the Streetlight.Vision CMS Web Server:

Citigis report	Uploads a file in a format specific to the CITIGIS software to an FTP server
Day burner report	Generates a report listing all devices that consumed more than 20 watts. This report is to be scheduled during the day, ideally after the switch OFF at sunrise.
Failures HTML report	Generates a report containing the list of failures detected in the selected geozone
Failures report	Uploads a text file listing the failures detected in the selected geozone to an FTP server for use by a third party software
Generic device last values	Generates a report containing the latest value of selected attributes for all the . devices belonging to the selected geozone and sends it via email and/or uploads it to an FTP server
Generic device values	Generates a report containing all the values collected for the selected attributes for all the devices belonging to the selected geozone since the last time the report was generated and sends it via email and/or uploads it to an FTP server
Latency report	Generates a report containing the time difference between the moment a command was sent to a device and the moment the device applied that command
Lifetime report	Generates a report compiling the percentage of expected lamp lifetime for all Streetlights belonging to the selected geozone
Low power factor report	Generates a report listing the devices with a power factor lower than 0.6. To change this configurable value, please change this report's config.xml file on the server
No data ever received	Generates a report listing the devices that never sent any data to the SLV CMS software
OnOff Segment report	Generates a report containing the switch on and off times of the mains supply inside the street lighting cabinet for all Controllers belonging to the selected geozone
Over 140V voltage report	Generates a report listing the devices with a mains voltage above 140 Volts. To change this configurable value, please change this report's config.xml file on the server
Over voltage report	Generates a report listing the devices with a mains voltage above 245 Volts. To change this configurable value, please change this report's config.xml file on the server
Over wattage report	Generates a report listing the devices with a consumed power above 125% of their lamp's

Over wattage report	Generates a report listing the devices with a consumed power above 120% of their lamps wattage. To change this configurable value, please change this report's config.xml file on the server
Symology report	Uploads a file containing the list of failures detected in the selected geozone and written in a format specific to the SYMOLOGY maintenance software to an FTP server
UMSUG report	Generates a file following ELEXON's Unmetered Supplies User Group (UMSUG) specification in the United Kingdom and uploads it to an FTP server. The Streetlight.Vision CMS passed the UMSUG certification in conjunction with certain LPCs. This file contains the time at which the LPCs executed ON, OFF and dimming commands, along with the list of failed LPCs and lamps in the selected geozone
Under 110V voltage report	Generates a report listing the devices with a mains voltage below 110 Volts. To change this configurable value, please change this report's config.xml file on the server

1 ' ~: 'tSj

Under voltage report	Generates a report listing the devices with a mains voltage below 210 Volts. To change this configurable value, please change this report's config.xml file on the server
Under wattage report	Generates a report listing the devices with a consumed power below 20% of the lamp wattage. To change this configurable value, please change this report's config.xml file on the server
Weekly Energy Report	Generates a report providing the energy consumption and energy savings for the selected geozone and its sub-geozones for the past week

- The "Alarm Manager" WebApp enables you to manage alarm definitions on the Streetlight.Vision CMS Web Server. Alarms can be defined based on several types of conditions (or "triggers") and against different types of equipment. Below is the list of all alarm types available in the Streetlight.Vision CMS Web Server:

Controller alarm: comparison between two/three/four I/Os	Checks whether certain logical conditions on the state of Outputs of a specified Controller are verified (e.g. Is the s DII?)
Controller alarm: last known state of an I/O	Checks whether the last known state of a Digital Input or a specified value
Controller alarm: no data received	Checks whether data has been received from a specified period
Controller alarm: ON/OFF at dusk/dawn	Checks whether a Controller's Digital Input or Output was a specified time around sunrise (or sunset)
Controller alarm:	Checks whether the time at which a specified Controller's

Controller alarm: ON/OFF times versus previous day	Checks whether the time at which a specified controller has been switched on (or off) today is different from that time
Controller alarm: state of the I/Os in the last hours	Checks whether the state of a Digital Input or Output of a value in the past N hours
Device alarm: critical failure or warning on a single device	Checks whether a critical failure or warning condition has selected device
Device alarm: data analysis vs previous day / (fixed time)	Checks whether a specified attribute of a device has sign behavior on the previous day
Device alarm: failure ratio in a group	Checks whether any of the specified failures has been de specified ratio of devices

Device alarm: multiple failures on multiple devices	Checks whether any of the specified failures has been detected on any of the specified devices
Device alarm: no data received	Checks whether data has been received from a device within a certain period
Device alarm: single failure on multiple devices	Checks whether any of the specified failures has been detected on more than a specified number of devices
Device alarm: too many failures in an area	Checks whether any of the specified failures has been detected on more than a specified number of devices within a circular area
Generic alarm: multiple triggered alarms	Checks whether more than a certain number of specified alarms are currently triggered at the same time
Meter alarm: comparison to a trigger	Checks whether a specified metering value of an Electrical Meter has exceeded a certain range
Meter alarm: data analysis vs previous day / (at fixed time)	Checks whether a specified metering value of an Electrical Meter has significantly deviated from its behavior on the previous day

EXHIBIT IB, ATTACHMENT 5: PRODUCT INFORMATION SHEETS

See following pages.
•ROOUCI DA IA SI'bbi

SILVER SPRING GEN5 NETWORK

AP 5.0 Cellular, AP 5.0 Ethernet

Leading utilities and cities have delivered breakthroughs in operational efficiency, customer service, and environmental sustainability by relying on Silver Spring's secure, reliable two-way connectivity to critical infrastructure. The Silver Spring GenTM5 network technology delivers the performance to continue the acceleration of critical infrastructure modernization initiatives. The AP 5 offers secure, flexible connectivity between the Silver Spring network and common wide area networks including Ethernet and cellular.

Flexible Communications for Diverse Applications and Environments

The Silver Spring Access Point 5 (AP 5) provides the central network resource for delivering data generated by endpoint devices at the network edge and IT/OT systems-enabling, high-performance applications, network control, and

- • 0.:iii

monitoring. Its flexible cdrijrnuniation features extend the reach and coverage of the network to thousands o(l)»ustomer sites, and its support for up to 5,000 endpoints per access*point dramatically lowers costs. The AP 5 offers multiple paths to each endpoint deviceIhrpugh sophisticated mesh network routing that ensures greater rehaipil ty' and redundancy

Cutter" Enj)sair*ri.

CuHwmarO

LEI

sivt

SttverUnk Data Pittffwwi

StlvwlLink Network Pbtffona

WAN

^ -6" ^

- 1)
- 2)
- 3)
- 4)

i he high-performance AP 5 dynamically adapts to optimize speed and coverage to a variety of devices while' securely and reliably delivering data fur multiple applications

INTEGRATION AND DEPLOYMENT SCENARIOS

Smsrt or id - ""': v lo-.v ry <v r. " r;p-:p'o d i^A.:!:)!)/

H v +/■<.:. \. <.o. :■!(■)» st:l;j '>■>.;"- - ;i j ■<>:'. <; cv<:

'■'KGJUCI' DAIA SHEET

SILVER SPRING GEN5 NETWORK

Relay 5

Leading utilities and cities have delivered breakthroughs in operational efficiency, customer service and environmental sustainabihty by relying on Silver Spring's secure, reliable two-way connectivity to critical infrastructure. The Silver Spring Gen""5 network technology delivers the performance to continue the acceleration of critical infrastructure modernization initiatives. The Silver Spring Relay and Access Point work together to relay data from endpoints to IT/ OT systems The Relay 5 extends the network to cost effectively reach more device endpoints.

Extending Reach and Coverage for Cost-Effective Communications

Third-Party Applications-^

The Relay 5 works with the AP 5 to deliver data generated by endpoint devices at the network edge and IT/OT systems-enabling nigh performance applications, network control and monitoring. Its flexible communication features extend the reach and coverage of the network. The Relay5 provides multi-hop capability between Silver Spring-enabled endpoint devices and the AP 5 for seamless integration.

x.SilverJnk AppJi<M&3R5

j. L^h&L&s '<■ „ LI;_Ji
 [Attnncvd M**tf mg Manager SLVS Operations Optfinlwr T CurtorncfIO f. 1^" t' j
 b^unLttf-cydtMiragfTOrt: CityMarta^rrrrfii^A^y^f and VVaikN** P^itwiny.Kivjfftwini:~ J \E3.<-jf;
 ^3

".* S IvertinVbata Platform"

SilverLmk Network Platform

/ wan" V_



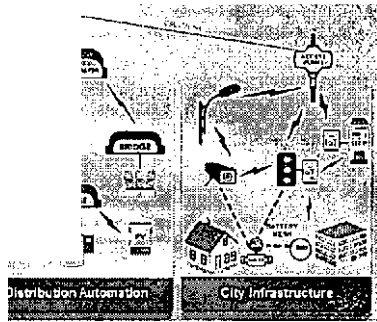

wail

:: Advanced M^stringw^

The Relay 5 in conjunction with the AP S extends the speed and coverage of the network to deliver high-capacity data, securely and reliably from the edge devices to a variety of IT/OT systems

INTEGRATION AND DEPLOYMENT SCENARIOS

Features

GenS-based networking technology with performance optimization

- » Up to 2.4 Mbps data speeds
- » 10 ms latency
- » Open standards-based two-way communications and interfaces
- » IPv6, IEEE 802.15.4g, Wi-SUN compliant
- » Increased system performance and data throughput
- » 900 MHz and 2.4 GHz

» 32 MB RAM and 32 MB flash

Key Benefits

The Relay 5 couples secure, reliable performance with open standards-based IPv6 communications to enable cities and utilities to cost effectively integrate mission-critical control and monitoring processes.

Expanded opportunity for performance-intensive multi-application services The Relay 5's support for a data rate up to 2.4 Mbps and 10 ms latency enables cities and utilities to roll out new services and increase customer satisfaction with engaging applications. Gen5 also includes a dual-band mesh capability that nearly doubles network capacity as devices can transmit and receive on both the 900 MHz and 2.4 GHz bands simultaneously.

Comprehensive and cost-effective coverage of diverse territory

The Relay 5 delivers cost-effective coverage while ensuring maximum overall system performance by dynamically adapting the data rate to optimize
5)reliable information delivery over a long range in the most challenging
6)environments

#. |

Risk mitigation through proven multi-layer security

Two-way communications remains protected from the increasingly hostile threat environment by building on Silver Spring's proven, multi-layer security that leverages built-in controls from the application-to-device layer.

Reduced time-to-value

The Relay 5 can be deployed on a broad array of existing assets. Mounting kits are available for installing relays on distribution poles, street lights, and walls, and inside pad-mounted enclosures.

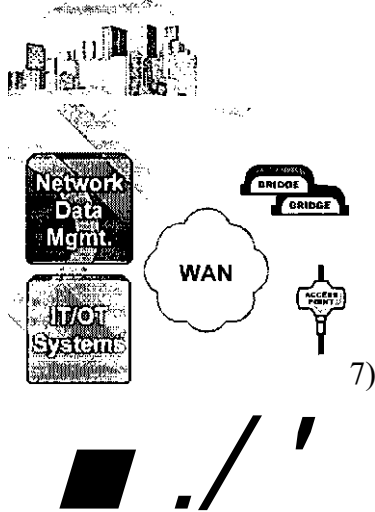

8)

9)

BRIDGE

(relay)
? / On

The Relay 5 delivers the low latency and high data rates to enable the most demanding multi-application initiatives

About Silver Spring Networks

Silver Spring Networks enables the Internet of Important Things™ by reliably and securely connecting things that matter. Cities, utilities, and companies on five continents use the company's cost-effective, high-performance IoT network and data platform to operate more efficiently, get greener, and enable innovative services that can improve the lives of millions of people. With more than 24 million devices delivered, Silver Spring provides a proven standards-based platform safeguarded with military grade security. Silver Spring Networks' customers include Baltimore Gas & Electric, CitiPower & Powercor, ComEd, Consolidated Edison, CPS Energy, Florida Power & Light, Pacific Gas & Electric, Pepco Holdings, and Singapore Power. Silver Spring has also deployed networks in Smart Cities including Copenhagen, Glasgow, Paris, Providence, and Stockholm. To learn more, visit www.ssn.com. Rev. 1/17/2017

Copyright © 2014-2017 Silver Spring Networks. All Rights Reserved. All trademarks are the properties of their respective owners

Corporate Headquarters 230.W Tasman Drive San Jose, California 95134 Office+1 669 770 4000 Toll Free +1 866 204 0200

Silver Spring

NETWORKS

www.silverspringnet.com <<http://www.silverspringnet.com>>

Specifications

Communications

1)

2)

3)

4)
5)
6)
7)
8)
Protocols/Security

Physical Interfaces.. Power

Data rate 6 25 kbcs to 2 4 Mbps

Frequencies ,902-928 MHz:ahc)S'4000i2'4835 GHz (USA) Frequencies: 870-875 6 MHz (EU, UAE)

Spread spectrum technology FHSS " ** VI'.

Modulation FSK, O-QPSK, or OFDM - adaptive gear, shifting ., ': -' _ . . .

Transmitter.output. 900 MHz -1 W, 870 MHz - 500 mW ERP, 2 4 GHz-500 mW^Ste^1 Output imoedance. 50 ohms

Addressing Internet P'oiccol version 6 {IPv6) Security Secure I Sash Algorithm 256 bit (SHA-256) and RSA-1024 or ECC-256

Encryption Advanced Encryption Standard (AES-128 or AES-256) Antenna connectors.,NType«lt;emale:?'^:;Y^:~^:lt;A^; r-

Power Input range 96 to 277 VAC, 50 to 60 Hz

Operating temperatu's- -40.V~,to +85°C (-40°F to +185°F) Humidity 0% tol?5%, non-conc^m^ng

Dimensions?.,)l) 0 cm (13 78") L x 21 1 c<n (8 32") W x 9 2 cm (3 62") H

Weight,kgs (Kt&s)

Enclosure IP65^white, aluminum

Mounting'KhV" Options

9)
10)
11)
Approvals^^

12)
13)

Memory

'Wcoderpole ■ -^'jonc^i-i-poleT^1-. . Lie:" pole

wall : ■

FCC Part 15 247 Industry Canada RSS-247 EU ETSI EN 303 204 32|Sb732 MB Flaf^RAtv|?

14)
Power Consumption:

Table with 2 columns: Relay, Idle 4 8 W. Includes 'Relay with Battery' row.

About Silver Spring Networks

Silver Spring Networks enables the Internet of Important Things™ by reliably and securely connecting things that matter. Cities, utilities, and companies on five continents use the company's cost-effective, high-performance IoT network and data platform to operate more efficiently, get greener, and enable innovative services that can improve the lives of millions of people.

Smart Cities including Copenhagen, Glasgow, Paris, Providence, and Stockholm. To learn more, visit www.silver-spring.com. Rev. 1/17/2017
Corporate Headquarters 230 Tasman Drive San Jose, California 95134 Off: +1 669 770 4000 Toll Free: +1 866 204 0200

Silver Spring

NETWORKS *by*

Copyright © 2014-2017 Silver Spring Networks. All Rights Reserved. All trademarks are the properties of their respective owners.

SELC External CMS Module

The SELC External CMS luminaire module with embedded Silver Spring communications provides reliable, secure, two-way control and monitoring for outdoor lights. Control and visibility allow for longer life, rapid repair, accurate energy monitoring and operations reporting. Used for adding control to existing lights of as part of an LED renovation project, the Silver Spring Connected technology has proven resilience and manageability across millions of network endpoints.

SELC redefined street lighting expectations in 1982 with the industry's first long-life photocell, some of which are still operational over 30 years later. SELC External CMS Modules employ the patented SELC Relay Assisted Triac (RAT) switching technique, to reliably switch reactive lighting loads year after year.



SELC External CMS Module



#1

Module

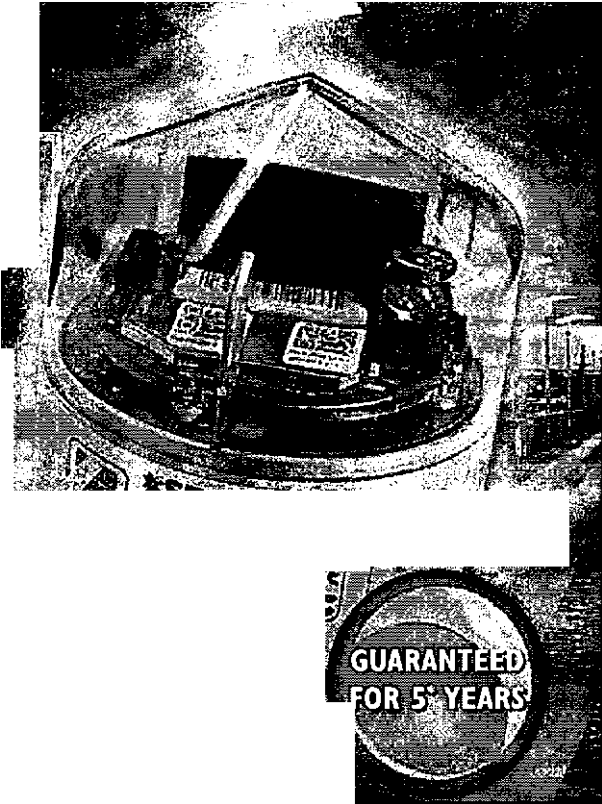

Secure, Proven, Two-Way Lighting Control For Any Deployment

17)
Silver Spring
lip

.....

Key benefits of the External CMS Module

- Proven SELC quality and reliability with over 30 years of lighting control experience
- Proven Silver Spring networking technology - Over 17 million connected devices
- Up to 65 % energy savings when deployed in conjunction with LED lights
- Up to AO % operational savings through control and monitoring
- Robust multilayer security with end-to-end encryption and full PKI (X.509) infrastructure
- Redundant, auto-healing, auto-configuring network using open standards such as IPv6 and IEEE 802.15.4g
- Over-the-air configuration and firmware upgrades
- Economic scalability from small pilots to metropolitan or countrywide deployments
- Energy metrology at 1 % accuracy, with per day, per hour, or per minute records and robust utility billing integration

www.selclighting.com <<http://www.selclighting.com>>

SELC External CMS Module

The SELC external and internal modules with integrated Silver Spring communication Streetlight Vision CMS front-end software provide the best-in-breed solution for efficient luminaire operation. The robust network capabilities such as jiffy allow the network to support a traffic-light control, parking automation and other networked sensors for enhanced living.

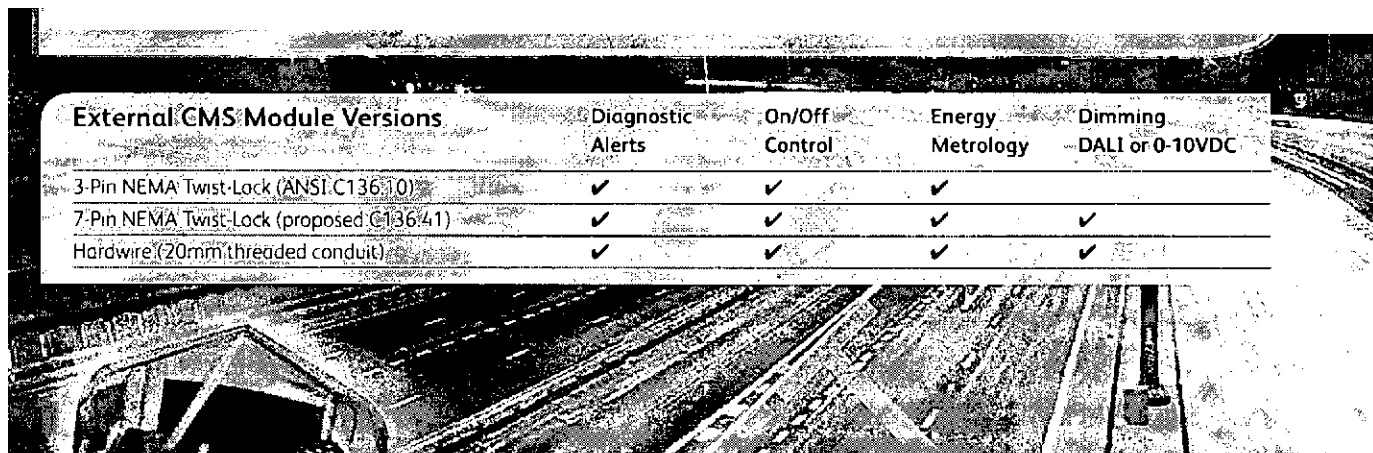

External CMS Module Versions	Diagnostic Alerts	On/Off Control	Energy Metrology	Dimming - DALI or 0-10VDC
3-Pin NEMA Twist-Lock (ANSI C136.10)	✓	✓	✓	
7-Pin NEMA Twist-Lock (proposed C136.41)	✓	✓	✓	✓
Hardwire (20mm threaded conduit)	✓	✓	✓	✓



Technical Specifications

Metering Accuracy	1% Watt; 2% VRMS IRMS
Metering Range	90 - 320VAC, 8A RMS (48 - 62)Hz
Turn ON Light Level	1.5fc (Other levels available on request)
Housing Material	UV Stabilized Polycarbonate
Enclosure Sealing	IP65
Dimensions	H 3.54in (90mm) Or 4.53in (115mm) D 3.43in (87mm) Weight: 250g
Switch Ratio (OFF:ON) Ratios	1.5:1 (Also available - 1:1, 2:1, 0.5:1)
Guarantee	5 years*
Rated Load	1800VA 3 x 400W
Maximum Load Current	10 Amps
Operating Temperature Range	-40°C to +70°C (-40°F to +158°F)
Circuit Power Consumption	<2Watts Avg Power @ 120-VAC
Manufacturing Standard	EN ISO 9001:2008
Photo Control designed to satisfy the following standards	Applicable parts of BS5972, EMC EN55015, EN61547, EN61000-3-2, EN61000-3-3, UL773, CSA C22.2
Operating Voltage	105 - 305VAC (50/60Hz)
Options for controlling LED driver	DALI or 0-10VDC Non Isolated, Isolated available

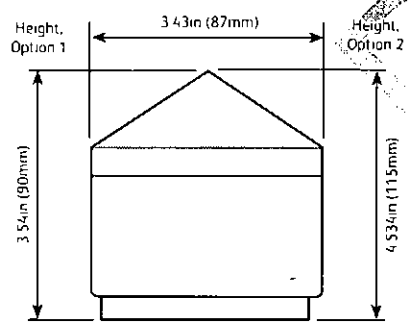

The Silver Spring solution includes multi-layer security policy enforcement and monitoring with end-to-end encryption (AES-128/256) and access control to ensure protection of critical infrastructure and data. Deployment options include full product

licensing, or CMS as a service.

- Silver Spring Networking Specification
- Powerful 1-wire radio, Frequency-Hopping Spread Spectrum up to 300kb/s mesh networking
- Automatic data routing with self-configuration, auto-healing & redundant uplinks
- IPv6 transport
- Full application & link-layer security with full PKI, AES-128 and -256, and embedded firewall

*Guarantee subject to SELC Terms & Conditions. All specifications subject to change without notice.

Guarantee subject to SELC Terms & Conditions All specifications subject to change without notice

SELC USA
481f> Holly Brook Drive Apex
NC27539
Tel (919) 723-10^6
Email: <idixon@seldighting.com>
SELC Ireland
Industrial Estate, Belmullet, Co. Mayo, Ireland
T+353 (0)97 81200 Email: info@selc.ie <mailto:info@selc.ie>
SELC Ireland Limited,
1)E3 Centrepoint, Rosemount Industrial Park, Ballycoolin, Dublin 11, Ireland
Tel: +353 (0)25 48020 Email info@selc.ie <mailto:info@selc.ie>

SELC WARRANTY

Selc Ireland Limited, E3 Centrepoint, Rosemount Industrial Park, Ballycoolin, Dublin 11, Ireland hereafter designated and trading as "SELC", guarantees that its CMS (Control and Management System) products are free from defects in their components and manufacturing for a period of (10) ten years from the date of manufacture inscribed by the manufacturer.

Definitions:

SELC: SELC Ireland Limited, producer of the products covered by this guarantee.

Products: Electronic modules produced by SELC; sensors, ballasts, CMS, communication modules, all identified by SELC logo, reference number, and serial number. End-User: The company who acquired the Products for installation in light fixtures and lanterns owned directly by the company or for a third party under an outsourcing contract or a financial construction. Typically the End-User is the legal owner of the Products.

The guarantee is valid only when these products are used with appropriate Road and Street Lighting that is in conformity with the standards in force in the European Union;,-This guarantee is reserved only for the company who acquired the Products, and following presentation of proof of purchase. This guarantee is null and void if the Products are not used in a normal way, or if SELC determines that the defect is caused by, but not limited to:



Short circuiting power factor correction capacitors if fitted/(nbt applicable to SELC ballasts)

Abnormalities in the gas-discharge arc tube.

Incorrect wiring insulation shorting to earthing parts or metal parts.

Incorrect fusing or means of protection against abnormal mains conditions.

Abnormality in the connected load. (e.g. Lightning discharge, unusual mains transients, mains surges, mains

brown outs etc) - V

Ingress of water, condensation/into the Luminaire or Electrical Cabinets, (applicable to SELC electronic ballasts, accessories and internal fitted photo electric lighting controls and time clocks)

Type of load connected to the SELC Product.

Any unusual abnormality in the incoming mains supply or the mains supply voltages as specified in our fitting instruction or catalogues. (The mains supplied to SELC Products must conform to the specification as outlined in the standard for the supply of AC mains in force in the EU Member States)

Modifications, tampering or any unauthorized attachments connected to the Products.

Accidental falls or misuse.

Unsuitable environmental conditions.

Operation beyond the useful life of the Products.

Malfunctioning Third Party components or products connected to the SELC Products.

- 1)
2)

Manufacturing- Sanmina Ireland Email- info@selc.ie <mailto:info@selc.ie> Tel: +353 25 48020 Directors P GayiH \Ct-Oi <file:///Ct-Oi>
Registered in Ireland .ir* S'.-LC i: rea'in "eorania .-' SELC liel.^ci .. iilil:)d Registered No. 'JbVW VAT No. iE S2Si:i01^

SELC Ireland Limited,
1)E3 Centrepoint, Rosemount Industrial Park, Ballycoolin, Dublin 11, Ireland.
Tel: +353 (0)25 48020 Email: info@selc.ie <mailto:info@selc.ie>
vnvw.saiclighUng.rom

- 1)
2)

SELC Products are only intended for the control of all types of outdoor LED and High Intensity Dis-Charge (HID) lighting uses, and are not designed or guaranteed for use in the control of other loads not similar to HID loads. SELC Products should be installed as per SELC's fitting instructions and any other necessary additional fitting recommendations supplied by SELC. SELC at all times should be made aware as to the type of loads its lighting control Products are controlling or connected to.

If a Product becomes defective according to the terms of this guarantee, SELC will examine the said Product, and, only at its own discretion, proceed to repair or replace it. SELC will then ship a Product similar in specification to the said defective Product in terms of its performance back to the user if it finds that the malfunction was as a result of a faulty component or design defect. If it is as a result of a faulty component and this was due to the component supplier's quality control or workmanship, SELC will hold the component supplier fully responsible for same. SELC will make every effort to pursue the component supplier costs associated with replacement the fitting and replacement of the Product arising from defect. Those said costs will be passed on to the user of thjefSefective SELC Product when received including any additional extra compensation claimed on behalf of the EndrUser. The only responsibility and exclusive recourse SELC will have concerning the recognized defects will be to repair ogreplace the product in question. SELC may, at its own discretion, replace it with a rebuilt product. In the case of a faulty^component delivered to SELC not fit for the purpose an Independent International Test Laboratory will-be used to determine that the said component was defective before approaching the said component supplier. A copy of the received independent test report will be forwarded to both the customer of SELC's Product and to the said component supplier.

This guarantee covers only the repair or the,replacement of the SELC defective Products listed in its catalogues: SELC declines all responsibility for any costs relatedttq|the*maintenance|and/or installation and/or removal of SELC's Products only the replacement on a one for one basis of-the supplied SELCPPProduct.



The End-User's sole remedy under this guarantee is set forth in this document. For any claim concerning performance or non-performance of SELC's Product under this guarantee, the End-User may recover actual damages up to the limit set forth in the following paragraph. .:;.4;:;.5;pm.f

SELC's liability for actual damages fronts any cause whatsoever will be limited to the amount of money the End-User paid for the Product that as] returned to SELC as a;defective Product.

- 3)

This limitation of liability will not ..apply to claims by you for bodily injury or damage to real property or tangible personal property or for replacement costs. IN NO EVENT WILL SELC BE LIABLE FOR ANY LOST PROFITS, LOST SAVINGS, INCIDENTAL DAMAGE, OR OTHER ECONOMIC OR CONSEQUENTIAL DAMAGES. This is true even if the End-User advises SELC of the possibility of such damages. SELC is not liable for any claim by the End- User based on a third party claim. This limitation of remedies also applies to claims against any Suppliers, Agents, Distributors and Remarketers of SELC's Products. SELC and its Suppliers' Agents, Distributors and Remarketers' limitations of remedies are not cumulative. Such Suppliers, Agents, Distributors and Remarketers are intended beneficiaries of this limitation.

SELC WILL IN NO WAY BE HELD RESPONSIBLE, UNDER ANY CIRCUMSTANCES AT ALL, FOR INDIRECT, CONSEQUENTIAL OR ACCESSORY DAMAGES, OR FOR THE LOSS OF LIGHTING.

- 4)

NOTE: SELC is committed not to terminate support of their Products, or to consider the Products obsolete, as long as the necessary components included in the Product are available on the market, and a reasonable demand exists from its clients for these Products.

- 5)
6)

Manufacturing- Sanmina Ireland Email: mfoiaiselc le Tel: +353 25 48020 Directors- P Guyci (CEO
Registered in Ireland ds SELC E rea'in "eorania .-' SELC liel;:^c: _ tnliioo Registered No. ii-jt:^!: VAT No. E l'o^~jli'l'
DAI A SI *:[L I



SILVER SPRING GEN5 NETWORK

AP 5.0 Cellular, AP 5.0 Ethernet

Leading utilities and cities have delivered breakthroughs in operational efficiency, customer service, and environmental sustainability by relying on Silver Spring's secure, reliable two-way connectivity to critical infrastructure. The Silver Spring Gen^{IM5} network technology delivers the performance to continue the acceleration of critical infrastructure modernization initiatives. The AP 5 offers secure, flexible connectivity between the Silver Spring network and common wide area networks including Ethernet and cellular.

Flexible Communications for C^Aerse Applications and Environments

The Silver Spring Access Point 5 (AP 5) pliovides the central network resource for delivering data generatecMsy'endpoint d'l^ces at the network edge and IT/OT systems-enabling^gh-performance applications, network control, and monitoring. Its flexible communication features extend the reach and coverage of the network to thousands or customer sites, and its support for up to 5,000 endpoints per access-point dramatically lowers costs. The AP 5 offers multiple paths to each endpoint dev^^through sophisticated mesh network routing that ensures greater reliability and redundancy.

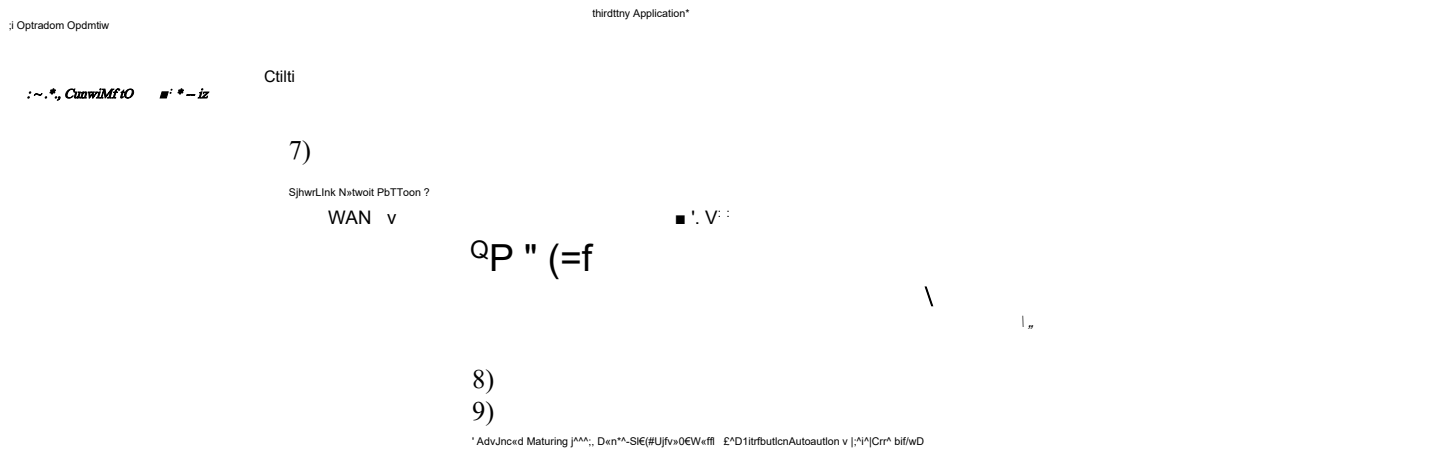

The hugh-performance AP 5 dynamically adapts to optimize speed and coverage to a vany of devices while' secuic-ly and lel ably delivering c.'al3 for multiple al iplu.iitkjns

INTEGRATION AND DEPLOYMENT SCENARIOS
i'KCOUCI DAiA SI ■!! 1

SILVER SPRING GEN5 NETWORK

Relay 5

Leading utilities and cities have delivered breakthroughs in operational efficiency, customer service and environmental sustamability by relying on Silver Spring's secure, reliable two-way connectivity to critical infrastructure lhe Silver Spring Gen^{IM5} network technology delivers the pe'ormance to continue the acceleration of critical infrastructure modernization initiatives. The Silver Spr ing Relay and Access Pomt work together to relay data from endpoints to IT/ OT systems. The Relay 5 extends the network to cost effectively reach more device endpoints

Extending Reach and Coverage for Cost-Effective Communications

The Relay 5 works with the AP 5 to deliver data generated by endpoint devices at the network edge and IT/OT systems⁵-enabling high performance applications,

network control and monitoring. Its flexible communication features extend the reach and coverage of the network! The Relay 5 provides multi-hop capability between

Third-Party Application

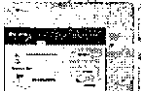

Silver Spring-enabled endpoint devices and the AP 5 for seamless integration.

Operations Optinutur
CutoffMjrIO

©111!
AdYBI>evd Metering Manager
SilverLinkpata Platform w./
SilverLinkNetwork Platform



Full LfKydidi ?<?> age mint.
Advanced Metering

S

r Distribution Automation s

The Relay 5 in conjunction with the AP 5 extends the speed and coverage of the network to deliver high-capacity data securely and reliably from the edge devices to a variety of IT/OT systems

INTEGRATION AND DEPLOYMENT SCENARIOS

SELC External

Silver Spring

Key benefits of the External CMS Module

- Proven SELC quality and reliability with over 30 years of lighting control experience
- Proven Silver Spring networking technology - Over 17 million connected devices
- Up to 65 % energy savings when deployed in conjunction with LED lights
- Up to 40% operational savings through control and monitoring
- Robust multilayer security with end-to-end encryption and full PKI (X.509) infrastructure
- Redundant, auto-healing, auto-configuring network using open standards such as IPv6 and IEEE 802.15.4g
- Over-the-air configuration and firmware upgrades
- Economic scalability from small pilots to metropolitan or countrywide deployments
- Energy metrology at 1 % accuracy, with per day, per hour, or per minute records and robust utility billing integration

www.selclighting.com <<http://www.selclighting.com>>

SELC External CMS Module

The SELC external and internal modules with integrated 60W LED, Sprng communications together with the advanced
 : ^tr.eetlightLVision CM^^ The robust :

External CMS Module Versions	Diagnostic Alerts	On/Off Control	Energy Metrology	Dimming DALI or 0-10VDC
3-Pin NEMA Twist-Lock (ANSI C136.10)	✓	✓	✓	
7-Pin NEMA Twist-Lock (proposed C136.41)	✓	✓	✓	✓
Hardwire (20mm threaded conduit)	✓	✓	✓	✓



Technical Specifications

Metering Accuracy	1% Watt, 2% VRMS/IRMS
Metering Range	90 - 320VAC, 8A RMS (48 - 62)Hz
Turn ON Light Level	1.5fc (Other levels available on request)
Housing Material	UV Stabilized Polycarbonate
Enclosure Sealing	IP65
Dimensions	H: 3.54in (90mm) Or 4.53in (115mm) D: 3.43in (87mm) Weight: 250g
Switch Ratio (OFF:ON) Ratios	1:5:1 (Also available - 1:1, 2:1, 0:5:1)
Guarantee	5 years*
Rated Load	1800VA 3x400W
Maximum Load Current	10 Amps
Operating Temperature Range	-40°C to +70°C (-40°F to +158°F)
Circuit Power Consumption	<2Watts Avg Power @ 120VAC
Manufacturing Standard	EN ISO 9001:2008
Photo Control designed to satisfy the following standards	Applicable parts of BS5972, EMC EN55015, EN61547, EN61000-3-2, EN61000-3-3, UL773, CSA C22.2
Operating Voltage	105 - 305VAC (50/60Hz)
Options for controlling LED driver	DALI or 0-10VDC Non Isolated, Isolated available

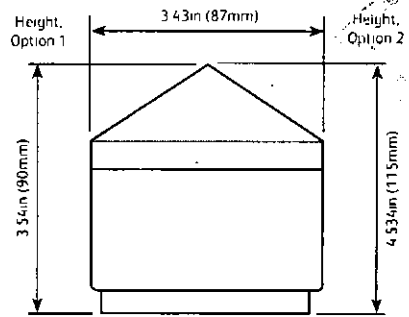

network capabilities and use of open standards such as IPv6, Jov^th'e network to support additional smart city applications such as traffic-light control, parking automation and other networked sensors for enhanced living.

The Silver Spring solution includes multi-layer security policy enforcement and monitoring with end-to-end encryption (AES-128/256) and access control to ensure protection of critical infrastructure and data. Deployment options include full products:

- .licensing or CMS as a service. j>C; i-, . J , ; ■

- 1)
- 2)

IP HE

Silver Spring^

Silver Spring Networkings Specification

Powerful^watt rndio.'Frequency-Hoppmg Spread Spectrum up to 300kb/s mesh networking
Automatic data routing with self-configuration, auto-healing &
redundant uplinks
IPv6 transport
Full application & link-layer security with full PKI: AES-128 and
256, and embedded firewall

Doc No SELC External CMS Module Rev 1

3)

'Guarantee subject to SELC Terms & Conditions All specifications subject to change without notice

SELC USA
1816 Holly Brook Drive
Apex
NC 27539
Tel (919) 723-1016
Ericnl adixonG-selclighting.com

SELC Ireland
Industrial Estate.
Belmullet, "AS^fsi^
Co Mayo. A***
Ireland
T+353 (0)9/81200

www.5eI CI \ Q U11' IH Q . CO ID
3 3

Email ,nfo@selc,e

W N: ■->

f , ■,-
Power Behino Light

Specifications

^Communications .-.k-, Data rate .6 25 kbps to 2 4 Mbpsw-:

Frequencies 902-928 MHz and 2 4000-24835 GHz (USA);

Frequencies. 870-875 6 MHz (EU, UAE)

' Spread spectrum technology FHSS

::^:~&t* -

Modulation FSK, C&PSK, or OFDM -adaptive gear shifting * I; Transmitter;butput ;900.MHz -1 W, 870

MHz-500 mW ERP, 2 4 GHz-500 mW Outputimpedance. 50 ohms j

Addressing Internet Protocol version 6 (IPv6) Security Secure Hash Algorithm 256 bit (SHA-256) and RSA-1024 or ECC-256

Encryption Advanced Encryption Standard (AES-128 or AES-256)

Antenna connectors'-NiType^Fernal . Power Input range 96 to 277 VAC, 50 to 60 Hz

Opei3gpjter^p^P%^pS^:i*«)Ir^ + 185°F)-: Humidity: 0%4o^95%,T.on-cohdecshq %:-:-

^^^...axm.

::jSS- -- *■ ■::^£:H-2: ■ ;

Dimensions'.35 0 cm (13 78") L x 21 1'cm IS 32") W x 9 2 cm (3 62") H Weight- 3 67 kgs (8.1 Jos) Enclosure IP65. white, aluminum

Mounting Kit Options

4)

5)

6)

Approvals

7)

8)

Memorjif-J^

WoGdei'-pole \'

■ ■ - -

Concrete pole Lini-t pole Wall

FCC Part 15 247 Industry Canaca RSS-247 EU ETSI EN 303 204

32 MB/32 MB Flash/RAM

: '■' "%^

9)

Power Consumption:

- » Public key-based authentication and AES-256 encryption
- » Increased system performance and data throughput
- * 900 MHz and 2.4 GHz radios
- » 32 MB RAM and 32 MB flash

Key Benefits

The AP 5 couples secure, reliable performance with open standards-based IPv6 communications to enable cities and utilities to cost-effectively integrate mission-critical control and monitoring processes.

Expanded opportunity for performance-intensive multi-application services

The AP 5's support for a data rate up to 2.4 Mbps and 10 ms latency enables cities and utilities to roll out new types of services and increase customer satisfaction with engaging applications. Gen5 also includes a dual-band mesh capability that nearly doubles network capacity, as devices can transmit and receive on the 900 MHz and 2.4 GHz bands simultaneously.

Comprehensive and cost-effective coverage of diverse territory

The AP 5 delivers cost-effective coverage while ensuring maximum overall system performance by dynamically adapting the data rate to optimize reliable information delivery over a long range in the most challenging environments.

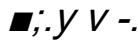

Risk mitigation through proven, multi-layer security

Two-way communications remains protected from the increasingly hostile threat environment by building on Silver Spring's proven, multi-layer security that leverages built-in controls from the application to device layer.

Rapid time-to-market with J-Flexible: integration

The AP 5 can be deployed on a broad array of existing assets. Mounting kits are available for installing APs on distribution poles, streetlights, walls, and inside partitioned enclosures. Multiple external antenna options are available to extend the AP 5's range and coverage levels.

The AP 5 delivers low latency and high data rates for the most demanding multi-application initiatives

About Silver Spring Networks
Silver Spring Networks enables the Internet of Important Things™ by reliably and securely connecting things that matter. Cities, utilities, and companies on five continents use the company's cost-effective, high-performance IoT network and data platform to operate more efficiently, get greener, and enable innovative services that can improve the lives of millions of people. With more than 24 million devices delivered, Silver Spring provides a proven standards-based platform safeguarded with military grade security. Silver Spring Networks' customers include Baltimore Gas & Electric, CitiPower & Powercor, ComEd, Consolidated Edison, CPS Energy, Florida Power & Light, Pacific Gas & Electric, Pepco Holdings, and Singapore Power. Silver Spring has also deployed networks in Smart Cities including Copenhagen, Glasgow, Paris, Providence, and Stockholm. To learn more, visit www.ssn.com. Rev. 1/17/2017

Copyright ©2014-2017 Silver Spring Networks. All Rights Reserved. All trademarks are the properties of their respective owners.

Corporate Headquarters ~ 230 W Tasman Drive ~ San Jose, California 95134 ~ Office +1 669 770 4000 Toll Free +1 866 204 0200

Silver Spring
NETWORKS

www.silverspringnet.com

Specifications:

Data rate- 6.25 kbps to 2.4 Mbps

Frequencies- 902-928 MHz and 2.4000-2.4835 GHz (USA)

Frequencies- 870-875.6 MHz (EU, UAE)

Spread spectrum technology FHSS



Protocols/Security

Modulation :FSKf 0.QPSK, onGFDm -adaptive.gear shifting Jf^ansmitter output 900 MHz-30 dBm (1 W), 870 MHz (500 mW ERP), 2.4 GHz-(500 mW)

Output impedance 50 ohms

WAN- Cellular! Eth^r^t; arid^Satellite

ffCeilular -4G LTE,;-';

Addressing Internet Protocol version 6 (IPv6) Security Secure Hash Algorithm 256 bit (SHA-256) and RSA-1024 or ECC-256

Encryption Advanced Encryptior Standard (AES-128 or AES-256) . Antenna connectb^ :

Power Input range^cyio 2774VAC, 50 to 60 Hz

Operating tetr.perature^30°C to +/0 °C 22°F to +158°F)

HumidL^0% to 95% ndn-condensmq Cellular/Etheii at

Dimensions 35iolcm (13 78") L x 21 1 cm (8 32") W x 9 2 cm (3 62") H & WelipSy<Q 8 lb)

Enclosure IF65, white, aluminum

Approvals

Mounting,Kit Options Memory

Wooden pole .^"!!F:r Concrete pole Light pole'

Wa"

FCC Part 15 247 Industry Canada RSS-247 EU ETSI EN 303 204 32 MB/32 MB^Flash/RAM'

,i\$R M"'

About Silver Spring Networks

Silver Spring Networks enables the Internet of Important Things™ by reliably and securely connecting things that matter. Cities, utilities, and companies on five continents use the company's cost-effective, high-performance IoT network and data platform to operate more efficiently, get greener, and enable innovative services that can improve the lives of millions of people. With more than 24 million devices delivered, Silver Spring provides a proven standards-based platform safeguarded with military grade security. Silver Spring Networks' customers include Baltimore Gas & Electric, CitiPower & Powercor, ComEd, Consolidated Edison, CPS Energy, Florida Power & Light, Pacific Gas & Electric, Pepco Holdings, and Singapore Power Silver Spring has also deployed networks in Smart Cities including Copenhagen, Glasgow, Paris, Providence, and Stockholm. To learn more, visit vAvw.ssni.com <http://vAvw.ssni.com>. Rev. 1/17/2017

Copyright © 2014-2017 Silver Spring Networks. All Rights Reserved. All trademarks are the properties of their respective owners.

Corporate Headquarters 230 W.Tasman Drive San Jose, California 95134 Off;-* +1 669 770 4000 Toll Frse+1 866 204 0200



www.silverspringnet.com <http://www.silverspringnet.com>

Power Consumption:

Idle^75W ■ C :-J^J Kjiyax 12 1 W-

Ethernet AP with Battery	Idle 7 5W	Max 18 1 W
Cellji^R-	Idle 9 3 W ■-Kc'	; Max 133 W.

Cellular AP with
Battery

Idle 9 8 W

Max 19 3 W

About Silver Spring Networks

Silver Spring Networks enables the Internet of Important Things™ by reliably and securely connecting things that matter. Cities, utilities, and companies on five continents use the company's cost-effective, high-performance IoT network and data platform to operate more efficiently, get greener, and enable innovative services that can improve the lives of millions of people. With more than 24 million devices delivered, Silver Spring provides a proven standards-based platform safeguarded with military grade security. Silver Spring Networks' customers include Baltimore Gas & Electric, CitiPower & Powercor, ComEd, Consolidated Edison, CPS Energy, Florida Power & Light, Pacific Gas & Electric, Pepco Holdings, and Singapore Power. Silver Spring has also deployed networks in Smart Cities including Copenhagen, Glasgow, Paris, Providence, and Stockholm. To learn more, visit www.ssn.com <<http://www.ssn.com>>. Rev. 1/17/2017

Copyright © 2014-2017 Silver Spring Networks. All Rights Reserved. All trademarks are the properties of their respective owners.

Corporate Headquarters 230 W Tasman Drive San Jose, California 95134 Off: +1 669 770 4000 Toll Free +1 866 204 0200

Silver Spring

www.silverspringnet.com <<http://www.silverspringnet.com>>

IIETWOrKSAy

SiiverSpring-Tj, Key Benefits of the Internal CMS® Module

Proven SELC quality and reliability with over 30 years of lighting control experience

Proven Silver Spring networking technology - Over 17 million connected devices

Up to 65% energy savings when deployed in conjunction with LED lights

Up to 40% operational savings through control and monitoring

Robust multilayer security with end-to-end encryption and full PKI (X.509) infrastructure

Redundant, auto-healing, auto-configuring network using open standards such as IPv6 and IEEE 802.15.4g

redundant, auto-healing, auto-configuring network using open standards such as IPv6 and IEEE 802.15.4g
Over-the-air configuration and firmware upgrades
Economic scalability from small pilots to metropolitan or country-wide deployments
Energy metrology at 0.5% accuracy, with per day, per hour, or per minute records and robust utility billing integration
Optional Button PhotoSensor available for Dusk / Dawn operation

1)
www.selclighting.com <http://www.selclighting.com>

SELC Internal CMS Module

1)
The SELC external and internal modules with integrated Silver Spring communications, together with the advanced Streetlight Vision XGMS front end software provide the best in class solution for efficient luminaire operation! the robust network capabilities and use of open standards such as IPv6 allow the network to support additional smart city applications such as traffic-light control, electric vehicle charging, parking, automation and other networked sensors for enhanced living. 4v
The Silver Springs solution includes multi-layer security policy enforcement and monitoring with end-to-end encryption control to ensure protection of critical infrastructure and data deployment. CMS as a service.

- 2)
- 3)
- 4)

,511111,

Technical Specifications

Metering Accuracy

Metering Range Housing Material Enclosure Sealing

* 2% VRMS, 2% IRMS, 1 % Watts, Energy +/-0.5% 1M: [^05^05v/50/60Hz] 8A RMS: , ~ ~ ^ : n "Main Housing and Button PhotoSensor :
UV Stable Polycarbonate Main Housing : IR65 Button 3 Phokv Sensor: IP67 (when fitted) Length: 106mm Height: 60mm Width:
86mm Weight : 295g. 5 years* -

Rated Load

5) Maximum Load Current;

1800VA 3x100W 10 Amps:™:

Operating Temperature Range -40°C to +70°C (-40°F to 1158°F):

Circuit Power Consumption - is

6) Manufacturing Standard

<2Watts Avg Power @120 VAC

; PhotoControl designed to satisfy the following standards!

EN ISO 9001:2008

Operating Voltage

Applicable parts of BS5972, EMC EN55015, EN61547 -EN61000-3-2; EN61000-3-3 and UL773, CSAC22.2

Compliances

10b-305VAG(50/60Hz)

RoHS, FCC, CE <http://RoHS.FCC.CE>

Silver Spring Networking Specification

Options for controlling LED driver: DALI 10-10VDC, Isolated, (Basic Isolation)

Powerful 1-watt radio. Frequency-Hopping Spread Spectrum

up to 300kb/s: mesh networking.

- Automatic data routing with self-configuration; auto-healing & redundant uplinks. ■■■■■

IPv6 transport .. -tj-ty, ■ 1 Full application & link-layer; security with full PKI. AES-128 and r256; and embedded firewall

SO
86

*Guarantee subject to SELC Terms & Conditions. All specifications subject to change without notice.

,4.

SELC USA

SELC Ireland

EH WL

181 b Holly Brook Drive
Apex
NC 27539
Tel (919) 723-10A6 n™,™™
Fmm: nriixonOse h in hlinn com
Fmoil: adixon@seklighlinq com

L'nii 1.3 .Ccntrepointi,
Roscninuilt Business ^^^^
Park. Hallycnolin, Sr
WWW.Se <http://WWW.Se> l d j 0 fl t i 11 Q .CO 171 tyjfe
LJJJ.13H1
DI 1X381
T 1353 (0)97 81200
Fmail info@selc.ie <mailto:info@selc.ie>

3 3
3 3" pi

Cy l3
Power Behind Light



-r* . , " • - ""-""Org.,- i

SELC External CMS Module

Secure, Proven, Two-Way Lighting Control For Any Deployment iijP^

Silver I
Spring^/1

Key benefits of the External CMS Module

- -Proven SELC quality and reliability with over 30 years of lighting control experience
- Proven Silver Spring networking technology - Over 17 million connected devices
- Up to 65 % energy savings when deployed in conjunction with LED lights
- Up to 40% operational savings through control and monitoring
- Robust multilayer security with end-to-end encryption and full PKI (X.509) infrastructure
- Redundant, auto-healing, auto-configuring network using open standards such as IPv6 and IEEE 802.15.4g
- Over-the-air configuration and firmware upgrades
- Economic scalability from small pilots to metropolitan or countrywide deployments
- Energy metrology at 1 % accuracy, with per day, per hour, or per minute records and robust utility billing integration

www.selclighting.conn <http://www.selclighting.conn>

mi

||||

The SELC external and Internal modules with integrated Silver Spring communications together with the advanced-Streetlight.Vision CMS front end software provide the best-in breed~solution for efficient luminaire operation. The robust network capabilities and use of,openstandards such as ILL6 dlipl^the™etworto as trafficlight control, parking automation and other networked sensors for enhanced living;|^ - . * ** <-4*->dv '

The Silver Spring'solution includes multilayer security pdlicy'enfdfcement and monitof iHg.with end-to-end encryption.^ES/ - * s138/2-5j6)idnd^ data, peploymentsoptiens^include^ >S*W&iE">' • ' "j licensing or CMS as a service. .

- Diagnostic Alert's
On/Off Control
- Energy Metrology
Dimming
DALI 6rO-10VDC<

: 3-Pin NEMATwist-Lock (ANSI.G136:-10)%'
7-Pin NEMA Twist-Lock (proposed C136.41)
»Hardwire;(20mm threaded conduit)«

- 1)
2)
3)
4)
5)

Technical Specifications

.1 % Watt. 2% VRMSIRMS
, 903320VAC, 8A RMS ('■& - 62)Hz:::
1.5fc (Otherlevels available on request) :
UV Stabilized Polycarbonate
IP65
. H 3.54m (90mm) Or 4 53in (115mm) D 3:43m (87mm) Weight. 250g
="1-5'1"(Also available -1:1. 2.1.0 5'1)

Guarantee
1800VA3x400W
6).10 Amps.

Rated Load
; Maximum Load Current -s
<2Watts'Avg-Power <s>120 VAC

^Operating Temperature Rang^ : j ;;;-40°C.to;K70'&(-40'F to +158'F)

Manufacturing Standard

Photo Control designed to satisfy the following standards

^CircuitPower-Consumption??

EN ISO 9001:2008
^Applicable parts of BS5972 - >

OperatingiVoltage*
EMC EN55015. EN61547 EN61000-3-2.EN61000-3-3 UL773 .CSA C22 2
105-305VAG(50/60Hz)

PptionS:for.coritrolling LED driver DALI or 0-10VDG Non Isolated, Isolated available.'

Silver Spring Networking Specification

-Powerful 1-wntt radio. FrequencyrHoppmg Spread Spectrum
up.to 300kb/s mesh networking ; -.
Automatic data routing:with self-configuration, auto healing & redundant uplinks IPv6 transport ..
Full application & link-layer security with full PKI. AES-128 and -256. and embedded firewall ■-:■

7)

*Guarantee subject to SELC Terms & Conditions All specifications subject to change without notice

SELC USA

4816 Holly Brook Duve Apex
NC 27539

Tel (919) 723-1046

Email odixonGPselchghting.com

SELC Ireland

8)Industrial Estate. Beln-ullet, Co. Mayo. Ireland

f 353 (0)97 81200 Email info@selc.ie <mailto:info@selc.ie>

1)

Silver Spring



FIELD SERVICE UNIT 4.0

2)

3)

4)

5)

6)

PRODUCT DATA SHEET



Compact field device for connecting to Silver Spring endpoints and infrastructure devices:

- » Establishes secure, encrypted connections with Silver Spring devices;
- » Pairs with numerous Silver Spring laptop and handheld tools for configuration, and upgrades
- » Enables field-based network reading when paired with optional Contingency Reader application and AMI back-office software

IN-THE-FIELD CONFIGURATION AND TROUBLESHOOTING OF ANY SILVER SPRING SMART GRID DEVICE

can be used by utility field engineers and technicians, for example, to wirelessly configure and troubleshoot Silver Spring Access Points, Relays, and Bridge devices that are mounted on utility poles or other hard-to-reach locations. The FSU can also connect to Silver Spring Gas IMU devices deployed on gas meters and Silver Spring NICs integrated with our partners' electricity meters.

The FSU, in conjunction with the Silver Spring Contingency Reader software, enables utility field personnel to manually read Silver Spring equipped electricity meters that are temporarily unreachable from the utility back office. In utility

Network Manager?

O'LN M:NLAKDS-PAS(D)INTEGHAIL*N

7)

8)

9)

10)

.->S/

11)



labs and meter shops, the FSU enables easy data collection and RF testing of devices OEM partners can use the FSU to pre-configure NICs before they leave the factory.

The FSU supports two modes of operations. A high-power mode offers a full one watt of transmit power; this mode requires AC power and so is suitable to fixed location or vehicle-mounted applications The FSU also supports a low-power mode, pulling power from the USB port of a host laptop for portable uses

To mitigate security threats, the FSU includes specialized hardware that enables it to establish secure, encrypted communications with Silver Spring devices. A secure association enables the user to perform a wider range of commands on the remote device, such as a remote disconnect on an electricity meter. For added security, the device offers the ability to require users to authenticate with a PIN before connecting to a Silver Spring device

923.9751 MHz (IDN) 4% 9.18-920 MHz (rHL)
922-928 MHz
902-9C7.5, 915-928 MHz (BRA)
870-876 MHz (KrHM; LUX, GBR) • 870-873 MHz (VIBRT); 865; 867 MHz (IND) 8iS-S6o VH/ (-AO Spread spectrum technology FHSS Transmitter power modes: 25% Low power (via USB) High power (via AC power adapter)

Receiver sensitivity -97 dBm for 1% PER Frequencies 2.4 GHz, ISM Band Data Rate 250 kbps Spreading Technique Direct Sequence MAC/Char"els 802.15.4/16
Addressing IPv6

Encryption: Advanced Encryption Standard (AES-128 or AES-256)

Security: Secure Hash Algorithm 256-bit (SHA-256), and RSA; 1024 or ECC-256

External AC Power Supply (optional)

Voltage 110-240 VAC

Frequency 5C/60 F-z

Physical:

Dimensions: 1.0" (2.5 cm) x 3.2" (8 cm) x 4.75" (12 cm), including exterior antenna

Environment
12) Certifications

20° C to +55° C (without adaptor) -20° C to +40° C (with adaptor) FCC Part 15.247

HEC 60950-1 (CB Scheme), IEC 60950-1, IEC 60950-2, IEC 60950-3, IEC 60950-4, IEC 60950-5, IEC 60950-6, IEC 60950-7, IEC 60950-8, IEC 60950-9, IEC 60950-10, IEC 60950-11, IEC 60950-12, IEC 60950-13, IEC 60950-14, IEC 60950-15, IEC 60950-16, IEC 60950-17, IEC 60950-18, IEC 60950-19, IEC 60950-20, IEC 60950-21, IEC 60950-22, IEC 60950-23, IEC 60950-24, IEC 60950-25, IEC 60950-26, IEC 60950-27, IEC 60950-28, IEC 60950-29, IEC 60950-30, IEC 60950-31, IEC 60950-32, IEC 60950-33, IEC 60950-34, IEC 60950-35, IEC 60950-36, IEC 60950-37, IEC 60950-38, IEC 60950-39, IEC 60950-40, IEC 60950-41, IEC 60950-42, IEC 60950-43, IEC 60950-44, IEC 60950-45, IEC 60950-46, IEC 60950-47, IEC 60950-48, IEC 60950-49, IEC 60950-50, IEC 60950-51, IEC 60950-52, IEC 60950-53, IEC 60950-54, IEC 60950-55, IEC 60950-56, IEC 60950-57, IEC 60950-58, IEC 60950-59, IEC 60950-60, IEC 60950-61, IEC 60950-62, IEC 60950-63, IEC 60950-64, IEC 60950-65, IEC 60950-66, IEC 60950-67, IEC 60950-68, IEC 60950-69, IEC 60950-70, IEC 60950-71, IEC 60950-72, IEC 60950-73, IEC 60950-74, IEC 60950-75, IEC 60950-76, IEC 60950-77, IEC 60950-78, IEC 60950-79, IEC 60950-80, IEC 60950-81, IEC 60950-82, IEC 60950-83, IEC 60950-84, IEC 60950-85, IEC 60950-86, IEC 60950-87, IEC 60950-88, IEC 60950-89, IEC 60950-90, IEC 60950-91, IEC 60950-92, IEC 60950-93, IEC 60950-94, IEC 60950-95, IEC 60950-96, IEC 60950-97, IEC 60950-98, IEC 60950-99, IEC 60950-100

AS/NZS CISPR 22/24 Resolution 506

HKVA1049 NTC TS 1010-2S50

13)

14)

About Silver Spring Networks

Silver Spring Networks is a leading networking platform and solutions provider for smart energy networks. Silver Spring's pioneering IPv6 networking platform, with over 22 million Silver Spring enabled devices delivered, is connecting utilities to homes and businesses throughout

Corporate Headquarters

555 Broadway Street

San Diego, CA 94063



the world with the goal of achieving greater energy efficiency for the planet. Silver Spring's innovative solutions enable utilities to gain operational efficiencies, improve grid reliability, and empower consumers to monitor and manage energy consumption. Silver Spring Networks' customers include major utilities around the globe such as Baltimore Gas & Electric, CitiPower & Powercor, Commonwealth Edison, CPS Energy, Florida Power & Light, Jemena Electricity Networks Limited, Pacific Gas & Electric, Pepco Holdings, Progress Energy, and Singapore Power, among others. For more information please visit www.silverspringnet.com or <http://www.silverspringnet.com>. Rev. 9/29/2016 NETWORKS/

Copyright © 2016 Silver Spring Networks. All Rights Reserved. All trademarks are the properties of their respective owners. Silver Spring Networks is a leading networking platform and solutions provider for smart energy networks. Silver Spring Networks' customers include major utilities around the globe such as Baltimore Gas & Electric, CitiPower & Powercor, Commonwealth Edison, CPS Energy, Florida Power & Light, Jemena Electricity Networks Limited, Pacific Gas & Electric, Pepco Holdings, Progress Energy, and Singapore Power, among others. For more information please visit www.silverspringnet.com or <http://www.silverspringnet.com>. Rev. 9/29/2016 NETWORKS/

Copyright © 2016 Silver Spring Networks. All Rights Reserved. All trademarks are the properties of their respective owners. Silver Spring Networks is a leading networking platform and solutions provider for smart energy networks. Silver Spring Networks' customers include major utilities around the globe such as Baltimore Gas & Electric, CitiPower & Powercor, Commonwealth Edison, CPS Energy, Florida Power & Light, Jemena Electricity Networks Limited, Pacific Gas & Electric, Pepco Holdings, Progress Energy, and Singapore Power, among others. For more information please visit www.silverspringnet.com or <http://www.silverspringnet.com>. Rev. 9/29/2016 NETWORKS/



1)

Silver Spring COMMUNICATIONS TESTER

- 2)
- 3)
- 4)
- 5)
- 6)

PRODUCT DATA SHEET

Laptop software that offers portable, flexible, and easy-to-use management of smart grid devices:

» Pairs with a Silver Spring Hold device to establish secure, encrypted maintenance links with field and job devices

* Enables on-site data collection and troubleshooting

Supports firmware updates, meter readings and more than 550 other communications

Supports field devices

The Silver Spring* Smart Energy platform combines network infrastructure, software, and professional services to enable a range of smart grid applications. To accommodate lab testing, partner OEM manufacturing, and in-field testing needs, Silver Spring has developed a set of handheld and laptop-based tools.

The Communications Tester is a PC-based application for field and lab testing of Silver Spring NICs, Access Points, Relays, bridges, Gas Interface-Managed Units (IMUs), and

other supported devices. In conjunction with the Silver Spring Field Service Unit (FSU), the

Communications Tester enables engineers and

technicians to transmit and receive messages to and from these devices, log the data, and analyze the results. For example, the operator can perform firmware upgrades, read meter tables, check configuration options, collect radio frequency statistics data, and exercise other troubleshooting features.

Communications Tester also supports user-created compound commands, session logging, and results export.

Communications Tester implements operator- and administrator-level permissions, and it features an automatic token countdown for

SilverSpring-^,

Copyright ©2014-2015 Silver Spring Networks. All Rights Reserved. All trademarks and registered trademarks are the properties of their respective owners. Rev. 10/19/2015
www.silverspringnet.com <<http://www.silverspringnet.com>>

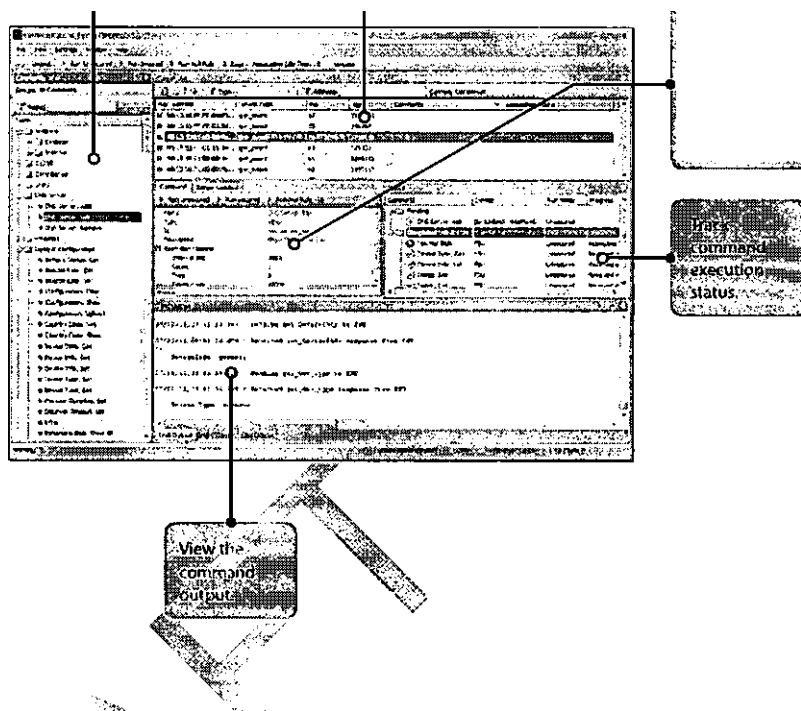

additional security This security feature tracks the number of operations a user performs and prevents the operator from performing additional operations once the allotted "tokens" are exhausted. Communications Tester is compatible with secure, encrypted FSUs and is backwards compatible to earlier versions of FSUs.

SYSTEM REQUIREMENTS:

- » Windows XP Service Pack 3
- » Communications Tester 6.0 supports Windows 7, 32-bit 64-bit, and Microsoft .NET Framework v4.0 SP1
- » USB port
- » Compatibility with USB hardware device drivers and with Microsoft ICCD smart card driver
- » CD-ROM drive (for application installation)

The Command list :h.w» j i H> Dtlce.List shows the .
 s device.,
 ••the predefined coiiiuc-ls ■ Silvs r 'jurllrig-devlc'es In . ■■■■"]
 •ithattap.be <http://%e2%80%a2ithattap.be> expcUed on *np n,-ige,;witri details such air
 | | sigrtal.strength. ••

- 1)
- 2)
- 3)
- 4)
- 5)
- 6)
- 7)
- 8)
- 9)
- 10)
- 11)
- 12)
- 13)
- 14)
- 15)
- 16)
- 17)
- 18)

18)
19)
20)
21)
22)
23)
24)
25)
26)
27)

Silver Spring* 9,
NETWORKS

Copyright © 2014-2015 Silver Spring Networks. All Rights Reserved.
All trademarks and registered trademarks are the properties of their respective owners. Rev. 10/19/2015 www.silverspringnet.com <http://www.silverspringnet.com>

Energy

inq

- 1)
- 2)
- 3)
- 4)

210+c

e
p
5)

hase M

I-210+c Singlephase Meter

The I-210+c is the latest addition to GE Energy's singlephase advanced meter family offering features beyond basic energy - such as demand, time of use, and load profile recording. It is GE's most robust and flexible meter, designed to offer utilities the ability to customize to suit their specific needs- adding or subtracting as much functionality as conditions require. The I-210+c also comes with the option of an integrated, factory-installed remote disconnect switch to help utilities more efficiently address issues such as non-payments, move-in, move-outs, and demand side management. The meter is also offered in network forms allowing utilities to more cost-effectively meter network services.

-The meter's hardware and software platforms are designed to be highly versatile, offering plug n-play capabilities for many features. In its simplest configuration, the I-210+c can act as a basic energy meter with no additional functionality. The design of the meter allows for easy

In its simplest configuration, the I-210+c can act as a basic energy meter, with no additional functionality. The design of the meter allows for easy upgrade of virtually all of the additional metering functionality available (with the exception of remote connect/disconnect, which must be installed at the time of order, at the GE factory). In its most robust configuration, the I-210+c acts as a flexible, advanced meter uniquely qualified to suit the needs of a dynamic utility environment.

Softswitches

With the addition of a Softswitch, the I-210+c can be enabled with advanced metering functionality and/or become compatible with a suite of third-party AMI solutions. The Softswitch, which is a software application used to enable the meter with additional functionality, can be loaded onto the meter at the time of order or after the meter has been put in service to add additional functionality to the meter. Features such as time-of-use, cycle insensitive demand, load profile recording, AMI communications, and event logging can be added.

I-210+c Available Softswitches:

- T₂: Time-of-Use
- E₂: Event logging of up to 200 events
- R₂: Demand and load profile recording (12-channel)
- Q₂: Power quality activates low voltage monitoring
- K₂: Second measure
- A₂: Alternote communications (AMI modules or other communication devices)

AMI Plug-n-Play

Many utilities are in the process of making AMI related decisions and many have chosen to utilize more than one AMI solution to effectively manage the needs of their service territory. For these reasons, the I-210+c has been designed to allow for the interchangeability of AMI modules (that GE is compatible with). AMI communications can be added at the GE factory, added after the fact, or changed out and replaced with another compatible AMI module should the meter be redeployed to another part of the service territory.

Cycle Insensitive Demand

With the appropriate softswitches enabled, the meter can be set to calculate "Cycle Insensitive Demand" based on a GE-proprietary algorithm. This provides an alternative method for calculating the maximum demand where one-way AMI systems are employed, and eliminates the need for manual demand reset with one-way AMI systems. This feature eliminates a significant limitation impacting utilities that have implemented, or who are considering implementing one-way AMI systems.

MeterMate* Meter Reading and Programming

- Change factory program defaults including measurement detents
- Set or change sag and swell thresholds

GE Energy's MeterMate software is compatible with the I-210+c and provides unparalleled flexibility for customers to read and customize their I-210+c. Some advanced features allow the user to:

- Select Demand, Demand/LP or TOU modes of operation and the use of the program manager to create and edit programs for the selected modes of the meter
- Perform a master reset to clear energy values, voltage * Transfer programs created to the I-210+c meter using MM Gomm. A.:- event and power fail counters in the MeterMate system
- Obtain a meter program and data summary report

The meter, is equipped with technology to more fully address a utility's safety concerns while ensuring the most efficient use of resources and protecting?

its revenues.

Remote Connect/Disconnect

- Situations involving non-paying customers
- New applications such as demand side management, emergency conservation, prepayment systems, customer system premises protection, and controlled outage restoration

The 1210-tc can be ordered with an integrated remote connect/disconnect switch mounted under the meter's cover. This is a factory installed option that must be specified at the time of order. To take advantage of all of the functionality this option offers, a two-way AMI device and system should be employed. This functionality is ideal for

¹ Locations with frequent move-in/move-outs and locations that are undesirable or dangerous. With this switch, the utility will be able to remotely connect or disconnect service and avoid sending a technician to the site

State-of-the-Art Tamper Detection

The I-210+c has an optional Event Log feature which captures information about the 200 most recent events that happen in the meter including reverse energy flow (caused by meter inversion). This can be used to check for confirmation of meter action or evidence of tampering.

I-210+c has enhanced features to help utilities improve the level of service they provide their ... customers.

IEEE Reliability Indices

The 1210+c has an optional power quality feature (activated when appropriate softswitches are added) that provides support for calculating IEEE® reliability indices (such as MAIFI, SAIFI, etc.) by collecting momentary and sustained interruptions and the accumulated duration of sustained interruptions.

Interval Recording

The interval recording option (which is enabled via a Softswitch), in addition to being used as a billing tool for the utility, can be used as a customer service tool which can provide the customer with useful data regarding their energy consumption

Meter specification and related information

Class

loofi

200 & 320

Form

IS 2S

3Sj& 3CS' 4S

w&h ■ ■

25S

1210+c Meter ANSI® forms.

Volts

■ 20 " X#P?S 20

120 & 240 ,: , 240

120 & 240-

200

200 & 320

240

-i20i&s4bl^r:;' •

120 & 240

■S^rcii^k- k-

A single polycarbonate cover is available with either of two variants including

- With RESET latch and Optocom "D" ring
- Plain cover without RESET or "D" ring
- I-210+c Display

Performance meets or exceeds ANSI C12.1, C12.10, C12.20, C37.90.1

For more information, please contact us via e-mail at energy@tdsolutions.com, or visit our web site at www.ge.com/energy

* In accordance with General Instruction C-31.01

Product Specifications

The FOCUS AX surpasses other meters in its class to deliver options you need for highly functional and affordable metering solution. The combination of the FOCUS Service Disconnect base module and powerful AX register supports a variety of connect/disconnect and service-limiting applications. The result: A single solution to manage demand, time of use, load point and reactive power with no costly upgrade.

Features such as reactive energy and power quality measurements deliver essential data to run advanced applications such as voltage monitoring, VAR control and load curtailment.

The E350JDCUS AX-SD incorporates a 200A, motorized disconnect/connect switch in the meter cover. This advanced, market-leading switch, coupled with the field-proven reliability of the E350 AX-SD, delivers Landis+Gyr's third-generation design answer to today's evolving utility requirements.

FEATURES & BENEFITS: *Why Landis+Gyr makes a difference.*

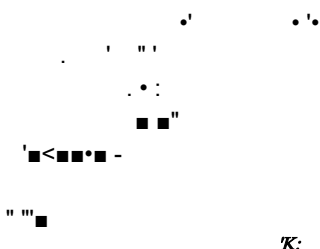

Product Specifications: E330 FOCUS AX and E350 AX-SD Single Phase

Specifications

General Specifications

Operating Temperature Nominal Voltage Operating Voltage
Frequency
Humidity
Starting Load (Watts),

Voltage Burden Load Performance Accuracy-Available Forms

Display Options

AMI Platform

Selectable Meter Multiplier Applicable Standards

Service Disconnect

International Certifications

Active Energy "kWh-kW" meter and Reactive Energy "kVA or kVAR" Digital Multiplication Measurement Technique

Non-Volatile Memory

Designed for 20+ years life

Meets ANSI standards for performance

Utilizes ANSI protocol (between meter and AMI device)

9-Digit LCD

Display scroll sequence programmable (factory or end user)

Configuration Port - cover does not have to be removed or optional ANSI C12.18 optical port available

-40C to +85C under cover 120V or 240V

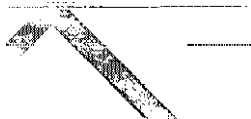

80% to 115% of Vn 60Hz +/- 5%

0.030 Amp (3.6W) 0.050 Amp (12W)

5% to 95% relative humidity, non-condensing

5% to 95% relative humidity, non-condensing

Class 20 0.005 Amp (0.6W)^{^^}

Class 320 Class 480 < 1.9W Max

Class 100 Class 200

0.080 Amp J19.2W 0.120Am[^](28;8W)

Yk A-'

Accuracy Class 1 2% (reactive-energy 0.5%)

Self-Contained IS, 2S/2SE, IPS, 25S

Transformer Rated 12S, 4S? K-Base. 2K

Energy Metrics: +kVWh, -kWh, Net kWh, and added kWh (Security), kVAh or kVARh

j.Metnc Energy Display Format - 4x1, 4x10, 5x1, 5x10, 6x1 or 6x10 Time of Use and Demand Billing

Modular <integrated

Up to 4096 as result of PT ratio • CT ratio li| ANSI C12.1 for electric meters

ANSI C12.10 for physical aspects of watt hour meters ; ANSI C12.18 Protocol specifications for ANSI Type 2 Optical Port ■"

ANSI C12.19 Utility Industry End Device Data Tables

ANSI C12.20 for electricity meters, 0.2 and 0.5 accuracy classes

CAN3-C17-M84 Canadian specifications for approval of type of electricity meters

10,000 operations at full rated current (disconnect/connect)

Available forms- IS, 2S, 12S, 25S

Measurement Canada (MC) AE-1641, AE-204 1 (integrated)

Phone. 678.258.1500 FAX- 678.258.1550

landisgyr.com <<http://landisgyr.com>>

dis Gyr

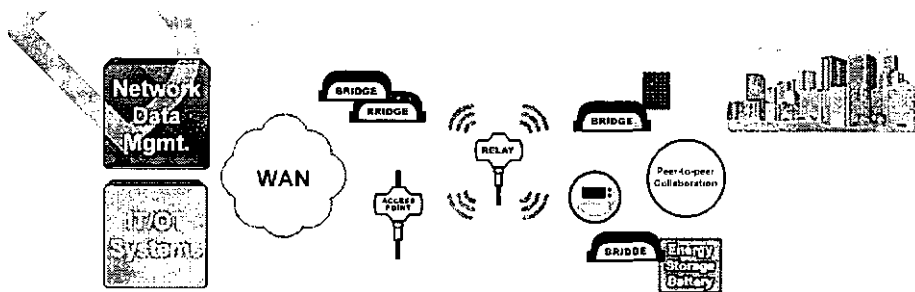

FEATURES

Secure, reliable performance to enable the most demanding smart infrastructure applications

- » Up to 2.4 Mbps data speeds
- » 10 ms latency
- » Open standards-based two-way communications and interfaces
- » IPv6, IEEE 802.15.4g, Wi-SUN compliant
- » Ethernet and cellular WAN options including 4G LTE
- » Dynamically adaptive data rates to ensure maximum performance while ensuring backwards compatibility

- » Integrated, open standards-based security
- » Public key-based authentication and AES-256 encryption
- » Increased system performance and data throughput
- » 900 MHz and 2.4 GHz radios
- » 32 MB RAM and 32 MB flash /

Key Benefits

The AP 5 couples secure, reliable performance with open standards-based IPv6 communications to enable cities and utilities to cost-effectively integrate mission-critical control and monitoring processes.

Expanded opportunity for performance-intensive multi-application services

The AP 5's support for a data rate up to 2.4 Mbps and 10 ms latency enables cities and utilities to roll out new types of services and increase customer satisfaction with engaging applications. Gen5 also includes a dual-band mesh capability that nearly doubles network capacity, as devices can transmit and receive on the 900 MHz and 2.4 GHz bands simultaneously.

Comprehensive and cost-effective coverage of diverse territory

The AP 5 delivers cost-effective coverage while ensuring maximum overall system performance by dynamically adapting the data rate to optimize reliable information delivery over a long range in the most challenging environments.

Risk mitigation through proven, multi-layer security

Two-way communications remains protected from the increasingly hostile threat environment by bundling on Silver Spring's proven, multi-layer security that leverages built-in controls from the application to device layer.

Rapid time-to-value, flexible integration

The AP 5 can be deployed on a broad array of existing assets. Mounting kits are available for installing APs on distribution poles, streetlights, walls, and side pad-mounted enclosures. Multiple external antenna options are available to further extend the AP 5's range and coverage levels.

The AP 5 delivers low latency and high data rates for the most demanding multi-application initiatives

About Silver Spring Networks

Silver Spring Networks enables the Internet of Important Things™ by reliably and securely connecting things that matter. Cities, utilities, and companies on five continents use the company's cost-effective, high-performance IoT network and data platform to operate more efficiently, get greener, and enable innovative services that can improve the lives of millions of people. With more than 24 million devices delivered, Silver Spring provides a proven standards-based platform safeguarded with military grade security. Silver Spring Networks' customers include Baltimore Gas & Electric, CitiPower & Powercor, ComEd, Consolidated Edison, CPS Energy, Florida Power & Light, Pacific Gas & Electric, Pepco Holdings, and Singapore Power. Silver Spring has also deployed networks in Smart Cities including Copenhagen, Glasgow, Paris, Providence, and Stockholm. To learn more, visit www.ssn.com. Rev. 1/17/2017

Copyright © 2014-2017 Silver Spring Networks. All Rights Reserved. All trademarks are the properties of their respective owners.

Corporate Headquarters 230 W Tasman Drive San Jose, California 95134 *Office+1 669 770 4000
Toll Free+1 866 204 0200



www.silverspringnet.com <<http://www.silverspringnet.com>>

Specifications:

<i>Communications</i>	<i>Data rate: 6.25 kbps to 2.4 Mbps</i>
	Frequencies 902-928 MHz and 2.4000-2.4835 GHz (USA)
	Frequencies 870-875.6 MHz (EU, UAE)
	Spread spectrum technology FHSS
	Modulation FSK, 0-QPSK or OFDM; adaptive gear shifting

Transmitter output 900 MHz-30 dBm (1 W), 870 MHz (500 mW ERP), 2.4 GHz-(500 mW) Output impedance 50 ohms

WAN- Cellular, Ethernet, and Satellite

Cellular -4G LTE

Protocols/Security Address-rig Internet Protocol version 6 (IPv6) Security Secure Hash Algorithm 256 bit (SHA-256) and RSA-1024 or ECC-256

Encryption Advanced Encryption Standard (AES-128 or AES-256)

Power Physical Interfaces, 1 Antenna connectors. N Type, remale

Power Input range-vo ro 2/Z VAC, 50 to 60 Hz

Operating temperature -30°C to +70°C (-22°F to +158°F); Humidity 0% to 95%, non-condensing

Cellular/Ethernet

Dimensions 35.0cm (13.78") L x 21.1cm (8.32") W x 9.2cm (3.62") H Weight 1.1kg (2.42lb) Enclosure IP65, white, aluminum

Mounting Kit Options

Approvals

Memory

Wooden pole

Light pole Wall: FCC Part 15.247 Industry Canada- RSS-247 EU ETSI EN 303 204

32 MB/32 MB Flash/RAM

About Silver Spring Networks

Silver Spring Networks enables the Internet of Important Things™ by reliably and securely connecting things that matter. Cities, utilities, and companies on five continents use the company's cost-effective, high-performance IoT network and data platform to operate more efficiently, get greener, and enable innovative services that can improve the lives of millions of people. With more than 24 million devices delivered, Silver Spring provides a proven standards-based platform safeguarded with military grade security. Silver Spring Networks' customers include Baltimore Gas & Electric, CitiPower & Powercor, ComEd, Consolidated Edison, CPS Energy, Florida Power & Light, Pacific Gas & Electric, Pepco Holdings, and Singapore Power Silver Spring has also deployed networks in Smart Cities including Copenhagen, Glasgow, Paris, Providence, and Stockholm. To learn more, visit mvu-5sni.com <http://mvu-5sni.com> Rev. 1/17/2017

Copyright ©2014-2017 Silver Spring Networks. All Rights Reserved. All trademarks are the properties of their respective owners.

Corporate Headquarters 230 Tasman Drive San Jose, California 95134 Office +1 669 770 4000 Toll Free +1 866 204 0200

Silver Spring

www.silverspringnet.com <http://www.silverspringnet.com>

Power Consumption:

Idle 7.5 W

Ethernet AP with Battery Idle 7.5 W

Cellular AP Idle <V 9 H W

Cellular AP with Battery Idle 98 W

About Silver Spring Networks

Silver Spring Networks enables the Internet of Important Things™ by reliably and securely connecting things that matter. Cities, utilities, and companies on five continents use the company's cost-effective, high-performance IoT network and data platform to operate more efficiently, get greener, and enable innovative services that can improve the lives of millions of people. With more than 24 million devices delivered, Silver Spring provides a proven standards-based platform safeguarded with military grade security. Silver Spring Networks' customers include Baltimore Gas & Electric, CitiPower & Powercor, ComEd, Consolidated Edison, CPS Energy, Florida Power & Light, Pacific Gas & Electric, Pepco Holdings, and Singapore Power. Silver Spring has also deployed networks in Smart Cities including Copenhagen, Glasgow, Paris, Providence, and Stockholm. To learn more, visit www.ssn.com. Rev. 1/17/2017

Copyright © 2014-2017 Silver Spring Networks. All Rights Reserved. All trademarks are the properties of their respective owners.

Corporate Headquarters 230 W Tasman Drive San Jose, California 95134 Office+1 669 770 4000 Tdirree+1 866 204 0200

Silver Spring

NETWORKS fj

www.silverspringnet.com <<http://www.silverspringnet.com>>

EXHIBIT IB. ATTACHMENT 6: WARRANTIES

See following pages.

4. AP and Relay Warranty

Limited Warranty for Equipment: Silver Spring warrants to End Customer that for 10 years from the date of End Customer acceptance

Limited Warranty for Equipment: Silver Spring warrants to End Customer that, for 10 years from the date of End Customer acceptance ("Equipment Warranty Period"), the Equipment will: (a) conform in all material respects to the specifications set out in its documentation; and (b) be free from material defects in materials and workmanship. The warranty provided in this Section covers problems reported to Silver Spring in writing during the applicable Equipment Warranty Period. Each item of Equipment is manufactured from new, or new and used parts. In some cases, the Equipment may have been previously installed. Regardless of the Equipment's production status, Silver Spring's warranty terms and conditions apply. A replacement may not be new, but will be in good working order and will be subject to the remaining term of the Equipment Warranty Period. If any unit of Equipment does not meet the above warranty during the Equipment Warranty Period, Silver Spring will, at Silver Spring's option and expense, and as End Customer's sole and exclusive remedy, repair or replace such non-conforming unit. Prior to returning a unit of Equipment for repair or replacement, End Customer must obtain from Silver Spring a return merchandise authorization ("RMA") number, which must be placed on all packaging, labelling, and other communications relating to the return. Silver Spring may require that the Equipment be evaluated prior to issuing an RMA number. Once Silver Spring confirms the nonconformity or defect and determines that it cannot be repaired at End Customer's site, Silver Spring will accept return of such Equipment for repair or replacement as promptly as possible.

J\$\$k> K V»V ^ Power Behind Light

SELC Ireland Limited,
E3 Centrepoint, Rosemount Industrial Park, Ballycoolin, Dublin 11, Ireland.
Tel. +353 (0)25 48020 Email: info@selc.ie <mailto:info@selc.ie>
www.>K!;:l!(hLfvu,crisi

SELC WARRANTY

Selc Ireland Limited, E3 Centrepoint, Rosemount Industrial Park, Ballycoolin, Dublin 11, Ireland hereafter designated and trading as "SELC", guarantees that its CMS (Control and Management System) products are free from defects in their components and manufacturing for a period of (10) ten years from the date of manufacture inscribed by the manufacturer.

Definitions:

SELC: SELC Ireland Limited, producer of the products covered by this guarantee.

Products: Electronic modules produced by SELC; sensors, ballasts, CMS, communication modules, all identified by SELC logo, reference number, and serial number. End-User: The company who acquired the Products for installation in light fixtures and lanterns owned directly by the company or for a third party under an outsourcing contract or a financial construction. Typically the End-User is the legal owner of the Products.

The guarantee is valid only when these products are used with appropriate Road and Street Lighting that is in conformity with the standards in force in the European Union. This guarantee is reserved only for the company who acquired the Products, and following presentation of proof of purchase. This guarantee is null and void if the Products are not used in a normal way, or if SELC determines that the defect is caused by, but not limited to:



Short circuiting power factor correction capacitors fitted. (hbt applicable to SELC ballasts)

Abnormalities in the gas-discharge arc tube.

Incorrect wiring insulation shorting to earthing or metal parts.

Incorrect fusing or means of protection against abnormal mains conditions.

Abnormality in the connected load. (e.g. Lightning discharge, unusual mains transients, mains surges, mains

brown outs etc)

Ingress of water, condensation? into the Luminaire or Electrical Cabinets, (applicable to SELC electronic ballasts, accessories and internal fitted photo electric lighting controls and time clocks)

Type of load connected to the SELC Product.

Any unusual abnormality in the incoming mains supply or the mains supply voltages as specified in our fitting instruction or catalogues. (The mains supplied to SELC Products must conform to the specification as outlined in the standard for the supply of AC mains in force in the EU Member States)

Modifications, tampering or any unauthorized attachments connected to the Products.

Accidental falls or misuse.

Unsuitable environmental conditions.

Operation beyond the useful life of the Products.

Malfunctioning Third Party components or products connected to the SELC Products.

C-UALI1 Y NSAI CCI tllc-d

Manufacturing: Sanmina Ireland Email- mfortjsselc le Tel- +353 25 48020 Directors' P Cjyc lChf.:>

Registered in Ireland as SELC E rcnri" "-;:oryi.i.j / SELC liei:;rC Lirpil-;:0 Reysteied No. 2brj3DI VAT Na. 'E *>:;o3jU.

krIV*

' ^ Power Behind Light

SELC Ireland Limited,
E3 Centrepont. Rosemount Industrial Park. Ballycoolin, Dublin 11, Ireland.
Tel: +353 (0)25 48020 Email info@selc.ie <mailto:info@selc.ie>

SELC Products are only intended for the control of all types of outdoor LED and High Intensity Dis-Charge (HID) lighting uses, and are not designed or guaranteed for use in the control of other loads not similar to HID loads. SELC Products should be installed as per SELC's fitting instructions and any other necessary additional fitting recommendations supplied by SELC. SELC at all times should be made aware as to the type of loads its lighting control Products are controlling or connected to.

If a Product becomes defective according to the terms of this guarantee, SELC will examine the said Product, and, only at its own discretion, proceed to repair or replace it. SELC will then ship a Product similar in specification to the said defective Product in terms of its performance back to the user if it finds that the malfunction was as a result of a faulty component or design defect. If it is as a result of a faulty component and this was due to the component supplier's quality control or workmanship, SELC will hold the component supplier fully responsible for same. SELC will make every effort to pursue the component supplier costs associated with replacement the fitting and replacement of the Product arising from defect. Those said costs will be passed on to the user of the defective SELC Product when received including any additional extra compensation claimed on behalf of the End-User. The only responsibility and exclusive recourse SELC will have concerning the recognized defects will be to repair or replace the product in question. SELC may, at its own discretion, replace it with a rebuilt product. In the case of a faulty- component delivered to SELC not fit for the purpose an Independent International Test Laboratory will be used to determine that the said component was defective before approaching the said component supplier. A/copy of the received^ independent test report will be forwarded to both the customer of SELC's Product and to the said component supplier. v

This guarantee covers only the repair or the replacement of the SELC defective Products listed in its catalogues: SELC declines all responsibility for any costs related to the maintenance and/or installation and/or removal of SELC's Products only the replacement on a one for one basis of the supplied SELC Product.

The End-User's sole remedy under this guarantee is set forth in this document. For any claim concerning performance or non-performance of SELC's Product under this guarantee, the End-User may recover actual damages up to the limit set forth in the following paragraph: ¹ Jjj\$jp&~-. 'ty

SELC's liability for actual damages from any cause whatsoever will be limited to the amount of money the End-User paid for the Product that was returned to SELC as a defective Product.

This limitation of liability will not apply to claims by you for bodily injury or damage to real property or tangible personal property or for replacement costs. IN NO EVENT WILL SELC BE LIABLE FOR ANY LOST PROFITS, LOST SAVINGS, INCIDENTAL DAMAGE, OR OTHER ECONOMIC OR

CONSEQUENTIAL DAMAGES. This is true even if the End-User advises SELC of the possibility of such damages. SELC is not liable for any claim by the End- User based on a third party claim. This limitation of remedies also applies to claims against any Suppliers, Agents, Distributors and Remarketers of SELC's Products. SELC and its Suppliers' Agents, Distributors and Remarketers' limitations of remedies are not cumulative. Such Suppliers, Agents, Distributors and Remarketers are intended beneficiaries of this limitation.

SELC WILL IN NO WAY BE HELD RESPONSIBLE, UNDER ANY CIRCUMSTANCES AT ALL, FOR INDIRECT, CONSEQUENTIAL OR ACCESSORY DAMAGES, OR FOR THE LOSS OF LIGHTING.

NOTE: SELC is committed not to terminate support of their Products, or to consider the Products obsolete, as long as the necessary components included in the Product are available on the market, and a reasonable demand exists from its clients for these Products.

Manufacturing: Sanmina Ireland Email mfolh@selc.ie Tel. +353 25 48020 Directors- P Gaytli iCEC)
Registered in Ireland ds SELC E renn- " -:;:;f.i.i / bL-Li; Irohnu Lirr il??o Registered No ^:

EXHIBIT 1C: ASSET CONDITION ASSESSMENT ATTRIBUTE LIST AND PLAN

The Contractor will perform an asset condition assessment, collecting and storing additional data about each streetlight and associated poles via a mobile application. As part of the Lighting Asset Condition Assessment, various attributes of each existing luminaire and light pole will be collected.

The Lighting Condition Attributes lists the information that Contractor will collect regarding the condition and attributes of Chicago's outdoor lighting infrastructure. The lighting infrastructure is divided into four (4) primary component categories: Light Poles, Luminaires, Wiring, and Controllers. The attribute list is broken up into three sections: Known Information, Needed Information, and Potential Additional Information.

- 1) Known Information - Identifying Attributes (Green):
 - This information is currently available through the CDOT Lighting GIS Database and is accurate as of January 1, 2014. While the GIS database contains additional information, the 13 attributes listed under the known section generally describe and define a particular individual lighting component; i.e. its unique identifying number(s), its location, and its type.
- 2) Needed Information - Type / Condition Attributes (Orange):
 - These attributes have yet to be collected and further define the component type and describes a visual assessment of its operating condition. This information is needed for making informed discretionary decisions about how best to allocate the limited resources earmarked for the Smart Lighting project targeted infrastructure repairs.
- 3) Potential Additional Information (Blue):
 - These remaining attributes fall under the category of "it would be good to know, but not absolutely necessary"; valuable information but not vital for Project completion.

Contractor has proposed a plan for a lighting condition assessment survey that collects, organizes, and integrates the "Needed" lighting condition attributes, attached in this Exhibit 1C, as well as some additional attributes.

Contractor shall comply with its lighting condition assessment survey plan, as outlined below in Attachment 1, which includes an implementation schedule, approaches for data collection, and methodologies for managing and delivering the required data.

Attribute Name

10 Character Unique Identifier

4-6 Digit Unique Identifier

m
43"

- o4« ' o

CDOT Atlas Page #

Pole Location (Address)

Pole Location (Latitude)
Pole Location (Zip Code)
Pole Location (GIS Coordinates)
Pole Location (GPS Coordinates)
Pole Location Type
Fixture ID#
Coach, Cobra, Flood, Ornamental, Viaduct
HPS, CMH, LED
Max Rated Wattage
Wattage Added By Ballast Draw

Attribute Name

Lighting context as defined in Exhibit A
(Lighting Specifications) of the RFP (e.g.,
Residential Legacy, Arterial (Feeder)
Legacy)

5 *c
C
<§|

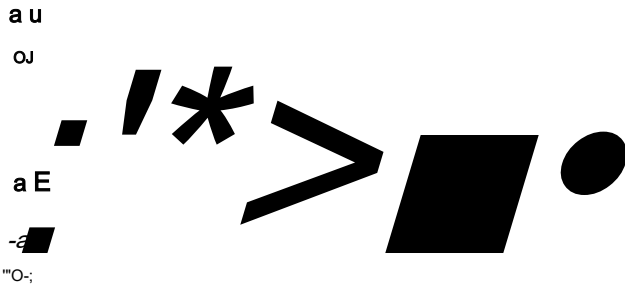

Pole Material Composition
Pole Height
Mast Arm Type
Mast Arm Material
Mast Arm Length
Pole Base Mount Type

Pole Condition - Leaning

Pole Condition - Corrosion

Pole Condition - Anchor Bolts

Additional Pole Accessories
Steel, Aluminum, Ornamental
Height approximated in feet.
Mast or Davit
Aluminum or Steel
4' 8' 12' 15'

1, 2, 3, 4, 5

Anchor Bolt, Ballast Box, Embedded (CTA, concrete, direct buried)

Use digital level to measure how plumb the pole is in degrees.

Examination of bottom 2 feet of pole to document extent of rust, holes, welding cracks, access panel doors, etc. on a scale of 1-5

Examination of anchor bolts to document extent of structural integrity on a scale of 1-5

Banners, Signage, Cameras, Transmitters, Traffic Signals (and how it is mounted), Sensors etc.

Underground, Aerial Temp, Aerial Perm

Attribute Name

26	Pole	Foundation Condition	Examination of exposed foundation top to document visually apparent structural issues on a scale of 1-5
27	Wiring	<i>Circuit tt</i>	Verify the circuit the pole is a part of (CDOT circuit numbers noted on GIS Atlas)
28	Controller	Controller Type	Pedestal, Pole Mounted, etc.
29	Controller	Controller Location	GPS Latitude and Longitude (coordinates)

EXHIBIT 1C, ATTACHMENT 1: CONTRACTOR'S ASSET CONDITION ASSESSMENT PLAN AND SCOPE OF WORK GENERAL

The Chicago existing outdoor lighting asset assessment will include a survey of all luminaires in the City's database including viaduct lighting. One of the initial steps in this process will be to build an accurate asset database that will become the database of record for ~332,800 luminaires. This database will ultimately reside within the Streetlight.Vision (SLV) software. An interim GIS system will be deployed to support the asset condition assessment and data migration from the City's current database to SLV. Esri's ArcGIS Server software will be used to publish the streetlight data in the form of mapping services. The data will be accessible through a publicly available read-only website and weekly exported report.

This inventory audit to be conducted by Contractor includes:

- Data reconciliation
- Field audit services
- Reporting throughout the audit and final data submission
- Approximately 332,800 street lights.

Contractor's GIS Audit System shall operate as follows and provide the benefits identified below:

GIS AUDIT SYSTEM OVERVIEW:

- A connected environment shall be used to allow simultaneous view or edit the of the contractor's central GIS database over the web.
- The database shall be hosted on a server in the Amazon Web Services Cloud.
- The server will run:
 - o Microsoft SqlServer o Esri ArcGIS for Server.
- The server is hosted in US West (Oregon) Region.
- The system is fully supported by Amazon, Microsoft and Esri.

GIS AUDIT SYSTEM BENEFITS:

- Identifying repeating occurrences
- Streamlined communication/troubleshooting between field auditors and project managers
- Management of asset history
- Real-time data sync between mobile devices
- Database is automatically backed up regularly

- Database is automatically backed up regularly
- Attachments (pictures from the field) are saved as part of the contractor's database

SCOPE OVERVIEW. Contractor shall perform the following high-level scope of work:

1. Preparation for Field work

- a. Reconcile controller data for attributes shown in the table of Exhibit 1C.
- b. Create Documents for Standards:
 - i. Field Manual
 - ii. Systems Architecture Document
- c. Implement, deploy and support a mobile/web GIS system
- d. Field survey logistics

2. Conduct transparent comprehensive field audit:

- a. Place the point representing the street light to the proper location based upon the aerial photo
- b. Confirm and/or correct existing street lighting:
 - i. Models
 - ii. Types
 - iii. Wattages.
- c. Audit of every light fixture listed in the CDOT lighting inventory database and associated pole
- d. Add fixtures found in the field not in current inventory
- e. Identify any fixtures in the inventory but not in the field.

3. Update street lighting inventory in the contractor's GIS database with post audit GIS products and/or tabular data.

SCHEDULE:

Contractor shall complete the audit within 217 calendar days (approximately 31 weeks).

- The first two weeks following issuance of Notice to Proceed are reserved for system setup, during which Contractor will prepare data and organize logistics
- 14 calendar days from Notice to Proceed: Audit field work begins
- 100 calendar days from Notice to Proceed - Completion of Phase 1
- 217 calendar days from Notice to Proceed - Completion of Audit

DETAILED SCOPE:

Pre-Field Work Preparation

Sample atlas page information shall be uploaded to the contractor's GIS system by the Contractor to create a base layer of information. This information will be used to initiate the audit.

- Approximately 332,000 street light points shall be defined as (green points) on the map, based upon their Latitude and Longitude values.
- Field check all controllers. Collect info as per the defined attributes specified in table in Exhibit 1C Review of existing Esri database and fields (All)
- Define minimum fields required by Asset Assessment

Write Standards Docs:

- Chicago Systems Architecture Document- how to set up the IT system which will manage edits and reporting
 - Clarification of geographic data and tables, domains, subtypes, mapping services, regularly ran processes, web applications, and reporting mechanisms
 - Systems Architecture Document will determine how to build the development system on a server running in the US West Oregon region of Amazon Elastic Compute Cloud
 - Testing and confirmation of proper functionality of test Chicago system before deployment of production server
- Chicago Field Manual- narrative instructions for how auditors will the access and use the system and the standard operating procedure for completing the audit, which shall include, at minimum, complete information on the following:
 - General information on mobile/web GIS system implementation, deployment, and support
 - How field survey logistics are communicated and coordinated
 - How to distinguish between data categories and how to move controller points
 - Safety standards
 - Public interaction
 - Training tool for new auditors
 - References for experienced auditors
 - Mobile application login use
 - Troubleshooting auditing wireless connections issues
 - Determining light attributes
 - Modifying data
 - Synchronization of offline edits

GIS Database

- The contractor's new GIS database will be placed in a central repository on a cloud server located in Oregon. Esri's ArcGIS Server software will be used to publish the street light data in the form of mapping services.
- The data will be accessible through:
 - A publicly available read-only website
 - Daily exported reports

Audit Deployment

- Audit data shall be collected and uploaded on a daily basis to the web server
 - The webserver shall maintain all data until SLV database is ready for data upload
 - The collection of data shall begin in areas designated by the City and may consist of arterial and residential streets simultaneously. The contractor shall use its own judgement in deploying its survey teams within the City's designated areas. At no time shall the City require the contractor to survey arterials or residential roadways that are not part of a defined atlas page.
 - Phase 1 shall be completed by the end of 100 calendar days immediately followed by the commencement of Phase 2 - the remainder of the city atlas pages. Phase 2 will be completed in an additional 117 calendar days.
-
- Phase 1 is anticipated to include 83,265 assets

Quality Control Contractor shall:

- Develop data entry protocols and programmatic error checking
- Develop and provide training protocols and on-going oversight
- Implement an iterative QA/QC process
 - In this process 100% of the first 1% (3,328 lights) of the estimated total number of streetlights (332,800) is independently recollected by the Contractor Project Manager (PM). Going forward 1% of each of the subsequent project's 10% of audited lights will be independently checked by the PM
- Conduct data entry through dropdown lists, number and date ranges, field types, and subtypes.
- Create the functionality that updates incorrect asset information. The Asset Condition Assessment will result in corrections to the existing datasets where observed field conditions are found to differ from the data already in the database. Also, some attributes will be added to the existing datasets. Currently, the GIS database includes a one-to-many relationship between pole data and the luminaire data. This relational data structure is currently not supported by SLV. The Contractor and its subcontractors will coordinate workflows to incorporate the proper relational database elements in the SLV software so that SLV can support the "pole-to-fixture" relationship. SLV will be configured to support asset management features and relationships of both poles (and other related infrastructure elements (e.g., circuitry) that support lighting) and lighting fixtures.

- Develop a map based website. A secure, read-only, queryable mapping website capable of showing all the audit data in real-time. The website will be easy to use and navigate (featuring an interface similar to Google Maps) and will clearly show the "status" of each street light. It will be accessible through any modern smartphone, tablet, or browser on a desktop. The website will give the stakeholders the ability to literally see the real-time progress of the audit. Users can select a GIS point and view current tabular data and any photographs taken in the field. Access to this site can be highly managed, with issued credentials, or it could be open to whomever Ameresco or the City wants to view it.

Reporting Spreadsheet

Contractor shall:

- Design and implement a customized Excel reporting process to track audit progress to the City on a weekly basis.. The executive summary report will provide accurate and up-to-date summary information on:
 - all atlas pages where all asset condition assessment field work has been completed,

 - a list of all the atlas pages that have complete condition attributes in the database,
 - total quantity of fully completed audited assets
- In addition a system will be implemented that exports an excel spreadsheet to an FTP site hosted by Audit subcontractor GIS. This spreadsheet includes multiple tabs focused on providing a clear picture of various aspects of the work. The raw data tab will present the tabular information in an unformatted way. On subsequent tabs there will contain a detailed data breakdown which includes critical information such as; the anticipated audit completion date based upon the last 7 days of auditing, how many lights each auditor has accomplished on each day and graphical representations (pie charts)breaking down the number of wattages audited and/or conditions of the audited lights.

Data Migration. The Contractor leverages the same database technology as the City of Chicago is currently using to manage its existing lighting database. an ESRI SDE Spatial Database. Details regarding the network security, versions of databases and Esri software will be

igning database, an Esri SDE Spatial Database. Details regarding the network security, versions of databases and Esri software will be discussed with the City.

Other information.

Data Security. Every individual editing data, auditors and installers, is required to enter individual credentials to make edits. Users accessing the data through read-only mechanisms are not required to enter credentials. The date and time of the audit data entry is recorded within the data. The user logged in is also recorded. Audit subcontractor issues the username and password. In order to use the system, Ameresco installers will need to submit the first and last name of the installers. Audit subcontractor will issue unique usernames and passwords.

Esri Software. Esri is the software vendor which audit subcontractor customizes to bring solutions aligned with client needs.

Archive. Data will be archived to another server nightly in a format where it can be republished quickly, if needed. This could be GIS Formats, like a shapefile or geodatabases, in an Excel spreadsheet, or a map series in PDF format.

EXCLUSIONS:

Limitations to Scope of Work

- The system outlined in this proposal is dependent upon other systems, including but not limited to Amazon Web Services, ArcGIS Online, and Verizon 4gLTE cellular networks.
- This scope does not include lights which are only accessible via boat, all-terrain vehicle, or hiking trails.
- The system runs on a hosted server in the Amazon Elastic Compute Cloud (EC2). This server is paid for hourly and therefore will be turned off and not available during low use times. The server will be available 6AM to 8PM Monday - Friday CST\CDT. The system can be turned on outside of this schedule if required under specific circumstances as requested by the City.
- The condition assessment is done from the ground and determining the wattage of each luminaire is dependent on the luminaire having a readable ANSI label on the bottom of the luminaire. If there is no label the auditors will not be able to determine the wattage.

LIST OF GIS AUDIT DATABASE FIELDS FOLLOWS.
List may be modified in writing by mutual agreement of the Parties.

GIS AUDIT DATABASE FIELDS (FINAbR&T-T0-BE-DETERMINED)

Data Field	Examples	Method to calculate/collect
Status (ObsStatus)	To be Audited, .. Suspended due to Modernization, ; i Successfully Audited, ; i . Audited with Review Requested, , : i;>.■; / .. ToBeQCed ' " % " % " ■ ' ' y, v' : : QCed ' ; ; 7, t ' 1 • ■ / ■ r ^ - V ' ■	Either manually changed or calculated programmatically.; Changed by Evari : : auditors to manage " progress. ;
Keywords (ObsKeywords)	, . ttlSOHps, #Tree, #FX2, #FX3 ' ['	Entered manually, this text is used to,. streamline data entry. Potentially a ' dropdown.
Original	CdotPoleNumber;-CdotCBIID#;CdotAtlasPage#, CdotPolellocationAddress,	All data provided, bys

LightStructure and ; - CdotPoleLocationZipCode/iddotPoleGisCoords, CdotPoleLocationGPSCoords, utility will be included
Fixture Data **: -r. CdotRoleLocationType, CdotLuminaireFixtureID#, CdotLuminaireFixtureType, in order to make direct
Provided CdotLuminaireLightType, CdotLuminaireFixtureWattage, • CdotLuminaireBallastLoss . will be prefaced? by
the utility abbreviation.
As identified
in Exhibit C.

Original Controllers CdotControllerId/iCdotControllerAtlasPage, CdotControllerAtlasPageGroup;^: Not Identified in Exhibit
Data Provided CdotControllerTypeCdotControllerVoltage, CdotControllerAddrNum; - C of the RFP, but
CdotControllerStreetDir, CdotControllerStreetName.iGdotControllerStreetType, -available. -All data
CdotControllerZipcode, CdotControllerWard provided by «= utility
will be included: in
order; to make: «J
■direct comparison. All
fields will be prefaced
by the utility
abbreviation

Pole, Number ; - 1234567890, 2345678901, 3456789012;45678901-23;1' .. Precalculated based
(ObsPoleNum) ./, upon CdotCBIJDtf,
Confirmed, corrected¹
or collected in the ; ,
field.

.,: Model (ObsModel) i- Cobra> Posttop-iGateway, Colonial, Flood, Other Decorative" ' Collected Manually in
the field through
observation.

Luminaire Wattage 70, 100/150, 250, 400, unknown ;_ Precalculated based
(ObsWatt) upon :GdotLuminaireFixtu
re, Wattage. Confirmed;;
corrected or collected^ in
the field; '*.

iLuminaire;Bulb Type: :: HPS, CMH, LED LPS, MV' si,, ' ' " *./#j:1,*.. " Precalculated based
(ObsBulbType) ' upon'
CdotLuminaireLightTy;
pe. Confirmed,
corrected/oracollecte t ,
in the field based¹ upon
NEMArLabel.

MastArmType V . ' Mast, Davit, other, none ,, Collected manually<in';
the field through .
observation..

Mast Arm Material ..Aluminum, steel, other, none Collected Manually in the
field through observation.

" ...^ . Mast Arm Length. l...t , -' . yf^r: 4';8', 12',-15'V;:t*- " ' ^,;> Collected Manually in "
the field through
observation.

Mast Arm Angle , '0, 15, 30, 45, 60, 75, 90, 105, 120, 135, 150, 165, 180; 195, 210, 225, 240, 255, . The direction the mast

(ObsMAAngle) . , . • 270,285,300,315,330,345 ' v • ' . l't ' arm is facing over the roadway.- Calculated , ..' programmatically,^ initially. Confirmed/Corrected in the field.

PoleLightingContextf Residential Legacy (66 Foot ROW, One-Sided?Light;Pole Configuration), Alley, B :. Assigned in the office" if possible, or otherwise; - (ObsLightContext) . Arterial (Feeder) Legacy (66 FootROW, One-Sidedlight Pole Configuration), ^Residential Modern: (66sFoot ROW; Staggered Light; Pole Configuration); Arterial (Large) (100 Foot ROW, Opposite Light Pole Configuration), Arterial (Medium) , ?^(8J3, Foot ROW, Staggered)^ 'l'.J.. Foot RO)W,^5iDegree Anglejfv/duct/Residential Coach. field. ;

Pole Material 1 v -' ■ Steel, Aluminum, Ornamental Collected manually in: the field

Composition. (ObsPoleMaterial)

Pole Height • 12-15 FT, 16-19 FT, 20-24 FT, 25-29 FT, 30-34 FT, 35-39 FT, 40 FT, OVER 40 FT, ,. , Collected manually in the field

(ObsPoleHeight) NONE, OTHER s

Pole Base Mount, Type Anchor Bolt; Ballast Box, Embedded (CTA;concrete, direct buried) ! - Collected manually in the field

Pole Condition -Leaning 1-2,3 ...20 ui Use digital level to ; nrj ea su r e? h ow; p 1 u m b t h e p o l e i s . i n d e g r e e s . ; ; ; Co 11 ected? manually-^.'^"in the field.

Pole Condition K'.pi;: iCorrpsion ' : >.- :- .g:yy "■^■'■^■r--^~^~; ■ 1 = Poor

'...(!' *<■ ^i j-^ V,^;,-.* -- ■' MV.^vi^."!^", ■

= Fair • -.,■<,~^v< E - K_v"" *"' • >;, 3=,Good

" -■.■>-w.~.,;:s;j -""■-""■_■:~:~:~:■ ■-' 4 = Very Good ', '- V ;.)f

" 5 = Excellent • """"'!

ib6t|qmf2:feet of pole lto p 2 bcument;extent ofVust, holes/welding , -cracks; access-panel "doors, etc; oh a scale ' of l- 5.:Collected _ manually in the field."

Pole Condition -Anchor Bolts • 1 = Poor 2 = Fair 3 = Good " 4 = Very Good 5 = Excellent

" Examination of . . anchor bolts to document extent of 'structuralintegrity on; a scale of 1-5.. Collected «manually:in'the field.

Pole-Foundation Condition - j' : ' ■** Good ,■ . * _ 5 = Excellent Examination of exposed foundation top to document visually apparent . . structural . . issues on a scale of 1-'..' 5. . Collected 'l. manually in the field.

Wiring Type- .. fx'V.r " " "" Underground, Aerial Temp; Aerial Perm'• -, '■] ' ■, •.'-la:f .Collected manually in ,,' • " ; the field

Wiring!Circuit# ..' ' * / . - •^•-^ . .wii'--' ■ s . /JJii :19976, 13185^13^8^13122, 13038, 18364, 13076, 13123, 13245, 1307j5i";i31;25i:' l;yerifyithexircuitthe .-' • , '[poie'pis'apart of (CDOTxcircuit i.il numbers! rioted, on-... GIS Atlas)

Controller, Type Pedestal;: Role Mounted, Residential, ResidentiakClock^Street Pedistal, Street Pole, Precalculated based V:

<p>Transclosure, other, none</p> <p>Controller Condition 1 = Poor 2 = Fair 3 = Good 4 = Very Good 5 = Excellent</p> <p>Controller Location 41.750807;-87.551519</p> <p>Audit DateTime (ObsAuditDate) " ' 2017-04-17 09:18:22 V;</p> <p>Auditor (ObsAuditor) V Carl Sorenson : ~</p> <p>Additional Pole Accessories - Banners, Signage, Cameras,;Transmitters; Traffic Signals (and how it is *4->>■'.*::■ mounted), ; " ..■"■-■:■"" ' - Sensors etc. ^r.-j,</p> <p>Field Notes (ObsNotes) Trees may block installation.</p> <p>Field Pictures (Stored as ^ attachments in. :■*.:. Geodatabase) XY Coordinate (Point_X, 41.8868428, 87.6270384 Point_Y)</p> <p>StatusHistory Audited 20170424, AuditQC 20170521 ■. ■" ■2^;:;... ^</p> <p>Link to Google Maps/Streetview (GoogleLink) httpDs://maps.google.com/maDs?outout=classic&q=41.8868428,-87.6270384&laver=c&cbl=41.8868428,-87.6270384&cbo=ll,0,0,0,0</p>	<p>upon CdotControllerType.'. Confirmed, corrected •or collected.'manually in the field Examination^.; document extent of corrosion, holes, Z®. welding cracks, ,.^, access panel.'.:./^* doors, etc. on scale of 1-5</p> <p>GPS Latitude and Longitude (coordinates) :t: ■: Calculated ; Automatic-allyibased on last?edited.:Stored as DateTimeitype field. Calculated ~ Automaticallyibased^ : on user login.</p> <p>■ ^Collected manually in the field Collected asVeeded (optional) ■tManual through field observation 'r- (Optional)</p> <p>Programmatically calculated based upon edited point ^locations/Stored in WGS84 '.. Latitude/Longitude coordinates: If point moves then then XY will be recalculated Programmatically Based on comparison to Status Yesterday Programmatically calculated based upon point location.</p>
---	---

Closest Street hi Address (Address)
 Calculated:
 Programmatically using many freely;
 available Locators.
 Manually writtemif: far from physical

address. *

Blue data is manually collected in the field, Green fields are original data, orange fields are calculated programmatically throughout the process.

Items identified with red border are additional information we proposed to collect at no additional cost and not required for the project.

Note: additional fields may be added through project development.

EXHIBIT 2: COMPENSATION

SEE FOLLOWING PAGES FOR COMPENSATION SCHEDULES.

- 1)
- 2)
- 3)
- 4)
- 5)
- 6)
- 7)
- 8)
- 9)
- 10)
- 11)
- 12)
- 13)
- 14)
- 15)
- 16)
- 17)
- 18)
- 19)
- 20)
- 21)
- 22)
- 23)
- 24)
- 25)
- 26)
- 27)
- 28)
- 29)
- 30)
- 31)
- 32)
- 33)
- 34)
- 35)
- 36)
- 37)
- 38)
- 39)
- 40)
- 41)
- 42)
- 43)
- 44)
- 45)
- 46)
- 47)

Compensation

EXHIBIT 2A - LED CONVERSION PRICING FORM

The City will compensate the Contractor for those LED Luminaires installed by the Contractor pre-Contract award as part of the Successful Proposer Comprehensive Luminaire Demonstration (required by Section 6.7.2 of Volume I of the Chicago Smart Lighting Project Request for Proposals), that were approved by the City, if they remain installed (and become part of the Project), based on the agreed upon unit prices for Phase 1 in this Exhibit.

For Phase 1, Contractor has proposed to procure the Luminaires identified in Exhibit 1A. Attachment A at the prices that follow, subject to the City's final selection and approval, but in no event shall Phase 1 Luminaires selected and approved by the City for any given lighting context exceed the corresponding unit prices set forth herein.

The City will pay monthly for luminaires included in those atlas grids or four (4) mile continuous arterial thoroughfare segments that have been completed and accepted.

LED fixture conversion unit prices shall serve as committed pricing for the initial Project Phase, and will be subject to price adjustment pursuant to Section 3.2.1.1 to the Contract to determine subsequent phase unit pricing. LED luminaire unit prices shall serve as committed pricing for the initial Project Phase, and will be subject to price adjustment pursuant to Section 5.7.4 of the Contract, to determine subsequent phase unit pricing. The quantity provided for each lighting context represents the City's best estimate of the number of fixtures included in the initial Project Phase, but does not represent a commitment to purchase such number of fixtures.

- 48)
- 49)
- 50)
- 51)
- 52)
- 53)
- 54)
- 55)
- 56)
- 57)
- 58)
- 59)
- 60)
- 61)
- 62)
- 63)
- 64)
- 65)
- 66)
- 67)
- 68)
- 69)
- 70)
- 71)
- 72)
- 73)
- 74)
- 75)
- 76)
- 77)
- 78)

Compensation

!...V/>' .|MI(fW3IK-

Residential Legacy (66 Foot ROW, One-Sided Light Pole Configuration)

General Electric	Item #4-	78.13	225.03	303.16
ERL2XPCBA1303000GR				

Leotek GC12-20H-MV-WV	Item #1	230.85	100.84	331.69
PCR7-WL				
<i>Existing Harness</i>				

Leotek GC12-20H-MV-WV	Item #2	96.87	100.84	197.71
PCR7-WL				

Arterial (Feeder) Legacy (66 Foot ROW, One-Sided Light Pole Configuration)

General Electric	Item #6	78.13	191.18	269.31
ERLH016B330AGRAYILU				

Residential Modern (66 Foot ROW, Staggered Light Pole Configuration)

Philips RFM-108W32LED	Item #3	78.13	129.80	207.93
-----------------------	---------	-------	--------	--------

Arterial (Large) (100 Foot ROW, Opposite Light Pole Configuration)

General Electric	Item #6	78.13	191.18	269.31
ERLH014B330AGRAYILU				

Arterial (Medium) (80 Foot ROW, Staggered Light Pole Configuration)

Philips RFL-180W80LED3	Item #6	78.13	\$276.10	\$354.23
------------------------	---------	-------	----------	----------

Residential-Reidefinital Intersection (66 Foot ROW, 45 Degree Angle)

General Electric	Item #5	78.13	\$263.71	\$341.84
ERL2 with Back				

Residential-Alley Intersection (66 Foot ROW, 45 Degree Angle)

General Electric	Item MS	78.13	\$263.71	\$341.84
ERL2 with Back				

Viaduct

Kenall DLD1220	Item #10	280.08	320.10	600.18
----------------	----------	--------	--------	--------

Residential Coach

Lyons View	Item U8	65.61	\$344.80	410.41
------------	---------	-------	----------	--------

Compensation

Retrofit

Arterial Acorn

Lyons View	Item #9	84.35	\$377.41	461.76
------------	---------	-------	----------	--------

Retrofit

*Park Pathway Cobrahead**

TBD	Item #7	128.10	TBD	TBD
-----	---------	--------	-----	-----

*Park Pathway Shoebox**

TBD	Item U7	128.10	TBD	TBD
-----	---------	--------	-----	-----

f Arterial Intersection One Sided

TBD	TBD	TBD
-----	-----	-----

Arterial Intersection Staggered

TBD	TBD	TBD
-----	-----	-----

Arterial Intersection Opposite 4 luminaires

re	TBD	TBD
----	-----	-----

; Arterial Intersection Opposite 8 luminaires 4 poles

TBD TBD TBD

*Phase 1 Park luminaires and corresponding luminaire pricing to be determined prior to Contract execution.

*Pricing shown for the Residential Coach and Arterial Acorn luminaires are for a LED lamp retrofit kit not for a new luminaire. The existing luminaire housing will be reused. Each retrofit kit will include an internal communications module. The labor to integrate the node to the retrofit kit is included in the price shown. The price for the node itself is a separate cost which is shown in the Technology pricing table that follows.

Figures in the table above for Fixture Conversion Unit Price and Total Price for Conversion do not reflect Contractor's markup provided for in Exhibit 2D to be applied to Fixture Conversion Unit Price.

- 1)
- 2)
- 3)
- 4)
- 5)
- 6)
- 7)
- 8)
- 9)
- 10)
- 11)

Compensation

EXHIBIT 2B - INFRASTRUCTURE STABILIZATION PRICING FORM

Although the below form provides committed pricing only for the initial Project Phase, the pricing provided in this form will be utilized in determining pricing throughout the term of the Contract, as outlined in Section 5.7 of the Contract.

Contractor must provide the unit price, including any labor, supervision, equipment, and material for each of the listed Infrastructure Stabilization work items provided in this form. Additional detail regarding the scopes of work and specifications associated with each work item is provided in Exhibit 10.

ITEM #	DESCRIPTION	UNITS	UNIT COST
1	REMOVE & INSTALL RESIDENTIAL POLE WIRE WITH GROUND	EACH	\$377
2	REMOVE & INSTALL ARTERIAL POLE WIRE WITH GROUND	EACH	\$391
3	REMOVE & INSTALL CABLE, ALUMINUM, AERIAL, 3 1/C #8, WITH MESSENGER	PER FOOT	\$3.50
4	REMOVE & INSTALL ELECTRIC CABLE, AERIAL, 1/C # 6	PER FOOT	\$2.00
5	REMOVE & INSTALL ELECTRIC CABLE IN CONDUIT, TRIPLEX 2 1/CN0.6,1/CN0.8	PER FOOT	\$6.10
6A	REMOVE RESIDENTIAL LEGACY POLE & MAST ARM, INSTALL RESIDENTIAL 20' POLE & 12' MAST ARM ALUMINUM (LABOR ONLY)	EACH	\$1,487
6B	FURNISH RESIDENTIAL 20' POLE & 12' MAST ARM ALUMINUM (MATERIAL ONLY)	EACH	\$1,127
7A	REMOVE ARTERIAL LEGACY POLE & INSTALL ARTERIAL	EACH	\$1,611

7B	STEEL, ANCHOR BASE, 15"B.C, 34' 6" (LABOR ONLY) FURNISH ARTERIAL POLE, STEEL, ANCHOR BASE, 15" B.C., 34'-6" (MATERIAL ONLY)	EACH	\$3,134
8A	REMOVE & INSTALL MAST ARM, STEEL, 8 FOOT (LABOR ONLY)	EACH	\$220
8B	FURNISH MAST ARM, STEEL, 8 FOOT (MATERIAL ONLY)	EACH	\$217
9A	REMOVE & INSTALL MAST ARM, STEEL, 12 FOOT (LABOR ONLY)	EACH	\$220
9B	FURNISH MAST ARM, STEEL, 12 FOOT (MATERIAL ONLY)	EACH	\$388
10A	REMOVE & INSTALL MAST ARM, STEEL, 15 FOOT (LABOR ONLY)	EACH	\$220
10B	FURNISH MAST ARM, STEEL, 15 FOOT (MATERIAL ONLY)	EACH	\$438

Compensation

11	PLASTIC POLE DOORS	EACH	\$23
12	REMOVE & INSTALL ALLEY LUMINAIRE WIRE WITH IN-LINE	EACH	\$261
13	PAINT BOTTOM 5' OF EXISTING POLE TO INHIBIT RUST CORROSION	EACH	\$431
14	PAINT EXISTING 20' RESIDENTIAL POLE	EACH	\$582
15	PAINT EXISTING 30' ARTERIAL POLE	EACH	\$700
16	PAINT EXISTING 8' MAST ARM	EACH	\$327
17	PAINT EXISTING 12' OR 15' MAST ARM	EACH	\$385
18	VIADUCT / UNDERPASS CONDUIT REPLACEMENT"	PER FOOT	\$36
19	VIADUCT / UNDERPASS WIRING REPLACEMENT	PER FOOT	\$3.40

Asset Condition Assessment Pricing Instructions:

The pricing provided below shall be for all costs associated with the approach to the Asset Condition Assessment proposed in the Contractor's Asset Condition Assessment Plan, as described in Exhibit 1C, exclusive of any overall project management costs, profit and overhead. The Project Management, Profit, and Overhead "Markup" in Exhibit 2D will be applied separately to the Total Cost of the Asset Condition Assessment Work submitted below. The pricing provided below, together with the applicable markup, will serve as a not-to-exceed budget for the full cost of the Asset Condition Assessment Work.

ITEM #	DESCRIPTION	TOTAL COST
1	COMPREHENSIVE ASSET CONDITION ASSESSMENT	\$2,522,980

- 1)
- 2)
- 3)
- 4)
- 5)
- 6)
- 7)
- 8)
- 9)
- 10)
- 11)
- 12)

- 13)
- 14)
- 15)
- 16)

Compensation

- 17)
- 18)
- /

EXHIBIT 2C - TECHNOLOGY/LMS COMPENSATION

The City will pay the Contractor for all LMS Services set forth in this Agreement pursuant to the unit prices set forth on the following pages. For all items with not-to-exceed quantities listed below. Contractor may utilize additional units if needed to achieve the performance levels agreed to in the Service Level Agreements in Exhibit IB. However, the City shall not compensate Contractor for any such items used in excess of the not-to-exceed quantities.

The City will pay monthly for nodes included in those atlas grids or four (4) mile segments that have been completed and accepted by the City. The City will pay monthly for other hardware components that have been accepted by the City.

The City will pay monthly for the labor and materials associated with modification to luminaire controller panels that have been completed and accepted by the City.

The City will pay quarterly for SaaS fees in arrears, based on the number of end points installed in the preceding quarter, prorated based on the date of acceptance by the City.

The City will pay monthly for the Implementation Service fees shown in Part 4 of the fee schedule that follows.

SaaS pricing based on 10 year term with escalation based on CPI for years 6 through 10. After the fifth anniversary of the Effective Date of this Agreement, SaaS pricing shall escalate based on CPI, indexed to the fifth anniversary of the Effective Date, based on the unit prices herein. "CPI" or "Index" means the "Consumer Price Index - U.S. City Averages for all Urban Consumers, All Items" (not seasonally adjusted) as published by the U.S. Department of Labor, Bureau of Labor Statistics; provided, however, that if the Index is changed so that the base year of the Index changes, the Index shall be converted in accordance with the conversion factor published by the U.S. Department of Labor, Bureau of Labor Statistics; provided further that if the Index is discontinued or revised during the Term, such other index or computation with which it is replaced shall be used in order to obtain substantially the same result as would be obtained if the Index had not been discontinued or revised.

The adjusted Contract price will be determined by performing the following calculation: The original unit prices herein will be multiplied by the quotient, and then be rounded to two (2) decimal places to calculate the adjusted Contract price(s). The quotient will be calculated by dividing the comparison index value by the average index value of the last twelve (12) months of the Contract period.

The comparison value for the first allowable price increase will be the index value at the time of the fifth (5) anniversary of the Effective Date of this Agreement. The comparison value for the second allowable price increase will be the index value of the sixth (6) anniversary of the Effective Date of this Agreement. The comparison value for the third allowable price increase will be the index value of the seventh (7) anniversary of the Effective Date of this Agreement. The comparison value for the fourth allowable price increase will be the index value of the eighth (8) anniversary of the Effective Date of this Agreement. The comparison value for the fifth allowable price increase will be the index value of the ninth (9) anniversary of the Effective Date of this Agreement. All price adjustment calculations will be based upon the latest version of the CPI available on the eighteenth (18th) day of the month following the anniversary of the Agreement. The effective date of an adjustment will be the twentieth (20th) day of the month following the month in which the adjustment is requested.

- 19)
- 20)
- 21)
- 22)
- 23)
- 24)
- 25)
- 26)
- 27)
- 28)

Compensation

1 SYSTEM AND LICENSING COSTS DETAIL

ITEM	Unit Cost	Not to Exceed Units Quantity
a	LMS Softv SaaS Fee\$ 1.31 Environme	
b	Third Part	•
c	Other Sys\$ 3,850.00 770.00	3
c	Other Sys Annual So	

2 NETWORK COST DETAIL

ITEM	Unit Cost	Not to Exceed Units Quantity
a	Network B\$ 9,309.55 and 9 Yea	46
	Relay w/ /\$ 2,275.76 \$ Total) Wa3,487.30 \$	5 51
	Access Pc12,046.78	
	Access Pc\$ 3,299.03 \$ Additional3,487.30	7 7

3 FIELD DEVICES COST DETAIL

1)

Compensation

ITEM	Unit Cost	Not to Exceed Units Quantity
a	Controllers	

LIGHT LE

External C\$ 69.10 96.81
 (10 Year T
 Internal C
 (10 Year T

CIRCUIT I

Viaduct LLS 96.81
 w/ 9 Year
 Utility Gra\$ 500.00

LIGHT LE

Installator\$ 1,760.00 \$
 Commissi7.24
 Module W\$ 412.38
 Controller \$ 464.35
 Firmware \$ 0.55

20

Luminaire:

Installator\$ 1,760.00 \$
 Modificatic1,034.53 \$ 7.24
 \$ 418.77

i
 Module
 Warrant
 y (0.3%
 per
 year) ii

Compensation

Firmware Maintenance \$ 0.66

TOTAL

4 IMPLEMENTATION SERVICES COSTS DETAIL

1)
 Business Analysis and Related Services
 System
 Integration
 Development
 Configuration, Testing and Acceptance

Not to Exceed Units Quantity

Data Migration

Project
 Management
 Other
 Implementation Services Costs
 Field Network Design

Endpoint \$ 218,280.46
 Installation
 : Support
 Network \$ 221,392.29
 Optimization
 Application \$ 115,500.00
 Deployment
 Services

Network \$ 112,366.37
 Deployment
 Support
TOTAL

5 TRAINING COSTS DETAIL - Detail all classes available including different levels of user training and administrator training if available.

Not to Exceed Units Quantity

2)
 3)
 Compensation

6 ADDITIONAL SERVICE FEES

ITEM	Not to Exceed Units Quantity
Unit	
Cost	
a	24/7 Customer j \$ Supp (annual) ! 212,500.00
	TOTAL!

• This technology pricing scenario is a combination of luminaire level control for all luminaires except the viaduct luminaires which will have circuit level control. The price shown for the viaduct luminaire circuit level control is to be considered as an ADD to the luminaire level control. It does not stand on its own because it is dependent on the installation of the communications network and the associated network services for which the price is included in the luminaire level control section.

• Various assumptions have been made to enable completion of this pricing. The price for the circuit level control of viaduct luminaires is based on the following assumptions: 16,000 viaduct luminaires, 20 viaduct luminaires per controller (equates to 800 controllers), 2 viaduct luminaire circuits (equates to 1600 circuits), non-viaduct luminaires are not comingled with viaduct luminaires circuits. Ameresco reserves the right to re-price the circuit level pricing of this form as site conditions differ from these assumptions.

-ADD \$6,000 each Access Point (46) for NEMA 4x Box with heater to meet -SOdegC spec. APs currently rated down to -30degC.

• Subscription software licenses included in SaaS Fees for the following applications: Street Light Adaptor (SLA) and Street Light.Vision (SLV).

• Software-as-a-Service (SaaS) pricing for additional environments can be provided upon request.

Pricing assumes Lighting Management System deployment will be done concurrent with the luminaire replacement.

• If no Lighting Management System options are selected or done at a later time, some lights e.g. alley lights will need external photocell to operate. This price is not included in Form 9 or Form 5 (incorporated into this Agreement as Exhibits 2C and 2A). Estimated \$13.25/luminaire.

• Unit pricing shown is firm but extended pricing is contingent on actual quantities.

• For Access Points (APs) and associated relays only the City will not incur additional costs beyond the costs shown on this Form 9 (Exhibit 2C) to furnish and install 46 APs and 5 relays should it be necessary to add more APs and relays to accommodate up to 350,000 exterior City and Parks luminaires. This will apply throughout the course of this project.

-

Compensation

EXHIBIT 2D-MARKUP FOR MANAGEMENT COSTS, PROFIT AND OVERHEAD

The below markup will be applied on all Work assigned through the Contract to cover any anticipated project management and implementation costs, profit and overhead. The markup shall be provided as a percent and will be applied to the anticipated costs of each Work Order assigned through the Contract, as calculated based on the quantity of each unit item assigned through the Work Order and the applicable unit price.

Note: The markup shall not be applied to LED Luminaire costs. Accordingly, for Work Orders associated with LED Conversion Work, the cost of LED Luminaires will not be included in the calculation of Work Order costs to which the markup will be applied. For the sake of clarity, the markup will be applied to the Fixture Conversion Unit Prices provided for in Exhibit 2A.

ITEM	DESCRIPTION	UNIT	MARKUP
1	PROJECT MANAGEMENT, PROFIT, AND OVERHEAD MARKUP	%	10%

Compensation

EXHIBIT 3: INSURANCE CERTIFICATE OF COVERAGE

Named Insured:

Specification #:

Address:

RFP:

(Number and Street)

Project #:

(City)

(State)

(ZIP)

Contract #:

Description of Operation/Location

The insurance policies and endorsements indicated below have been issued to the designated named insured with the policy limits as set forth herein covering the operation described within the contract involving the named insured and the City of Chicago The Certificate issuer agrees that in the event of cancellation, non-renewal or material change involving the indicated policies, the issuer will provide at least sixty (60) days prior written notice of such change to the City of Chicago at the address shown on this Certificate. This certificate is issued to the City of Chicago in consideration of the contract entered into with the named insured, and it is mutually understood that the City of Chicago relies on this certificate as a basis for continuing such agreement with the named insured:

Type of Insurance	Insurer Name	Policy Number	Expiration Date	Limits of Liability All Limits in Thousands
General Liability <input type="checkbox"/> Claims made <input type="checkbox"/> Occurrence <input type="checkbox"/>				CSL Per Occurrence \$ General Aggregate \$
Premise-Operations <input type="checkbox"/> Explosion/Collapse				Products/Completed Operations Aggregate \$
Underground <input type="checkbox"/> Products/Completed-Operations <input type="checkbox"/> J				
Blanket Contractual <input type="checkbox"/> Broad Form Property Damage				
<input type="checkbox"/> Independent Contractors <input type="checkbox"/> Personal Injury <input type="checkbox"/>				
Pollution				
Automobile Liability				CSL Per Occurrence \$
<input type="checkbox"/> Excess Liability <input type="checkbox"/> J Umbrella Liability				Each Occurrence \$
Workers Compensation and Employees Liability				Statutory/Illinois Employers Liability \$
Builders Risk/Course of Construction				Amount of Contract
Professional Liability				\$
Owner Contractors Protective				\$
Other				\$

- a) Each Insurance policy required by this agreement, excepting policies for worker=s compensation and professional liability, will read- The City of Chicago is an additional insured as respects operations and activities of, or on behalf of the named insured, performed under contract with or permit from the City of Chicago.
- b) The General, Automobile and Excess/Umbrella Liability Policies described provide for severability of Interest (cross liability) applicable to the named insured and the City.
- c) Workers Compensation and Property Insurers shall waive all rights of subrogation against the City of Chicago.
- d) The receipt of this certificate by the City does not constitute agreement by the City that the insurance requirements in the contract have been fully met, or that the insurance policies indicated by this certificate are in compliance with all contract requirements

Name and Address of Certificate Holder and Recipient of Notice

Signature of Authorized Rep
Agency/Company
Address
Telephone

Certificate Holder/Additional Insured

City of Chicago

Procurement Department

121 N LaSalle St., »806

Chicago, IL 60602

For City use only

Name of City Department requesting certificate: (Using Dept)

Address

ZIP Code.

Attention:

273

Attach completed certificate of insurance here.

CERTIFICATE OF LIABILITY INSURANCE

THIS CERTIFICATE IS ISSUED AS A MATTER OF INFORMATION ONLY AND CONFERS NO RIGHTS UPON THE CERTIFICATE HOLDER. THIS CERTIFICATE DOES NOT EXTEND OR ALTER THE COVERAGE AFFORDED BY THE POLICIES BELOW. THIS CERTIFICATE OF INSURANCE DOES NOT CONSTITUTE A REPRESENTATIVE OR PRODUCER, AND THE CERTIFICATE HOLDER.

IMPORTANT: If the certificate holder is an ADDITIONAL INSURED, the policy(ies) must have ADDITIONAL INSURED provisions or be endorsed. If certain policies may require an endorsement. A statement on this certificate does not confer rights to the certificate holder in lieu of such endorsement(s).

PRODUCER Arthur J. Gallagher Risk Management Services, Inc.
Avenue Boston MA 02210

Phone: 617-261-6700 | Fax: 617-646-0400

E-MAIL ADDRESS:

INSURER(S) AFFORDING COVERAGE NAIC#

insurer a: Zurich American Insurance Company 16535

insured AMERINC-17 Ameresco, Inc. 111 Speenansbury National Union Fire Insurance Company 19445
Framingham MA 01701

insurer c: Steadfast Insurance Company 26387

insurer d: Zurich American Insurance Company 27855

INSURER E :

INSURER F :

COVERAGES

REVISION NUMBER:

CERTIFICATE NUMBER: 1022023168

THIS IS TO CERTIFY THAT THE POLICIES OF INSURANCE LISTED BELOW HAVE BEEN ISSUED TO THE INSURED NAMED ABOVE FOR THE POLICY PERIOD INDICATED. NOTWITHSTANDING ANY REQUIREMENT, TERM OR CONDITION OF ANY CONTRACT OR OTHER DOCUMENT WITH RESPECT TO WHICH THIS CERTIFICATE MAY BE ISSUED OR MAY PERTAIN, THE INSURANCE AFFORDED BY THE POLICIES DESCRIBED HEREIN IS SUBJECT TO ALL THE TERMS, EXCLUSIONS AND CONDITIONS OF SUCH POLICIES LIMITS SHOWN MAY HAVE BEEN REDUCED BY PAID CLAIMS

INSR	TYPE OF INSURANCE	ADDL	INSD	SU	PO	POLICY EFF	POLI	LIMITS
LTR				BR	LIC	(MM/DD/YYYY)	CY	
				WV	Y	EXP		
				D	NU	(MM/		
					MB	DD/Y		
					ER	YYY)		
A	X COMMERCIAL GENERAL LIABILITY CLAIMS-MADE [X] OIY			Y	GLO5852388041	11/30/2016	11/30/2017	EACH OCCURRENCE \$2,000,000 DAMAGE TO PROPERTY \$500,000 MED EXP (Any) \$10,000 PERSONAL & AUTO \$2,000,000
	GEN'L AGGREGATE LIMIT APPLIES PER							GEN'RAL AGGREGATE \$4,000,000
	POLICY [x] JPERC of (JLIIOC OTHER							PRODUCTS - \$4,000,000
								\$
A	AUTOMOBILE LIABILITY X ANY AUTO	Y		Y	BA P58 523 870 4	11/30/2016	11/30/2017	COMBINED SINGLE LIMIT (Each accident) \$1,000,000
								BODILY \$

	OWNED AUTOSCHEDULED ONLY HIRED ED I AUTOS ONLY AUTOS	NC AL	JN-OWNED TOS ONLY							LI INJURY (Per person) BODILY INJURY (Per accident) PROPERTY DAMAGE (Per accident)	\$
B	UMBRELLA DAB	X	OC CUR CLAIMS - MADE	Y	Y	01379 1009	11/30/2016	11/30/2017	EACH OCCURRENCE		\$5,000,000
	EXCESS LIAB DED RETENTION \$								AGGREGATE \$		
A	WORKERS COMPENSATION AND EMPLOYERS' LIABILITY y, N/ANY PROPRIETOR/PARTNER/EXECUTIVE I 1 OFFICER/MEMBER EXCLUDED? (Mandatory in NH) If yes, describe under DESCRIPTION OF OPERATIONS below		N/A			WC 595 394 503	11/30/2016	11/30/2017	VI PER I OTH-A I STATUTE I IER		
									EL EACH ACCIDENT		\$1,000,000
									EL DISEASE - EA EMPLOYEE E L DISEASE - POLICY LIMIT		\$ 1,000,000
C D	Professional Liability Installation Floater					EO 927 430 6 PW G45 535 051 3	11/30/2016	11/30/2017	5,000,000 15,000,000		

DESCRIPTION OF OPERATIONS / LOCATIONS / VEHICLES (ACORD 101, Additional Remarks Schedule, may be attached if more space is required) RE:

Agreement for Chicago Smart Lighting Project Certificate holder is included as additional insured on the General Liability policy per form UGL-1175-F CW (04/13) and on the Auto Liability policy per form U-CA-424-F CW (04/14). Coverage is primary and non-contributory with any other insurance carried by or on behalf of the certificate holder. 60 days notice of cancellation, except 10 days for nonpayment of premium, is provided to certificate holder.

CANCELLATION

CERTIFICATE HOLDER

The City of Chicago Department of Transportation 121 N. LaSalle Rm 806 Chicago IL 60602

SHOULD ANY OF THE ABOVE DESCRIBED POLICIES BE CANCELLED BEFORE THE EXPIRATION DATE THEREOF, NOTICE WILL BE DELIVERED IN ACCORDANCE WITH THE POLICY PROVISIONS.
AUTHORIZED REPRESENTATIVE

ACORD 25 (2016/03)

logo are registered marks of ACORD

© 1988-2015 ACORD CORPORATION. All rights reserved. The ACORD name and

EXHIBIT 4: ECONOMIC DISCLOSURE STATEMENT AND AFFIDAVIT(S) See following pages.

EDS and Affidavits

CERTIFICATE OF FILING FOR CITY OF CHICAGO ECONOMIC DISCLOSURE

STATEMENT

EDS Number: 106358
Certificate Printed on: 03/28/2017

Date of This Filing:03/28/2017 06:55 PM
Original Filing Date:03/28/2017 06:55 PM

Disclosing Party: Ameresco, Inc.
Filed by: Ms. Mary Burns

Title:Proposal Coordinator

Matter: CITY OF CHICAGO LIGHTING PROJECT
Applicant: Ameresco, Inc. Specification #:
Contract #:

The Economic Disclosure Statement referenced above has been electronically filed with the City. Please provide a copy of this Certificate of Filing to your city contact with other required documents pertaining to the Matter. For additional guidance as to when to provide this Certificate and other required documents, please follow instructions provided to you about the Matter or consult with your City contact.

A copy of the EDS may be viewed and printed by visiting <http://webappsl.cityofchicago.org/EDSWeb> <<http://cityofchicago.org/EDSWeb>> and entering the EDS number into the EDS Search Prior to contract award, the filing is accessible online only to the disclosing party and the City, but is still subject to the Illinois Freedom of Information Act. The filing is visible online to the public after contract award.

**CITY OF CHICAGO ECONOMIC DISCLOSURE STATEMENT and AFFIDAVIT
Related to Contract/Amendment/Solicitation EDS # 106358**

SECTION I -- GENERAL INFORMATION

A. Legal name of the Disclosing Party submitting the EDS:

Ameresco, Inc. Enter d/b/a if applicable:

The Disclosing Party submitting this EDS is:

the Applicant

B. Business address of the Disclosing Party:

111 Speen St. Suite 410
Framingham, MA 01701 United States

C. **Telephone:**

630-203-2635

Fax:

508-661-2201 Email:
mburns@ameresco.com <mailto:mburns@ameresco.com>

D. Name of contact person:

Ms. Mary Burns

E. Federal Employer Identification No. (if you have one):

F. Brief description of contract, transaction or other undertaking (referred to below the "Matter") to which this EDS pertains:

CITY OF CHICAGO LIGHTING PROJECT

Which City agency or department is requesting this EDS?

DEPT OF PROCUREMENT SERVICES

Specification Number

Contract (PO) Number

Revision Number

Release Number

User Department Project Number

SECTION II - DISCLOSURE OF OWNERSHIP INTERESTS

A. NATURE OF THE DISCLOSING PARTY

1. Indicate the nature of the Disclosing Party:

Publicly registered business corporation

Is the Disclosing Party incorporated or organized in the State of Illinois?

No

State or foreign country of incorporation or organization:

Delaware

Registered to do business in the State of Illinois as a foreign entity?

Yes

B. DISCLOSING PARTY IS A LEGAL ENTITY:

1 .a.1 Does the Disclosing Party have any directors?

Yes

1 .a.3 List below the full names and titles of all executive officers and all directors, if any, of the entity. Do not include any directors who have no power to select the entity's officers.

Officer/Director:

Title:

Role:

Mr. George P Sakellaris

Chairman / CEO

Both

Officer/Director:

Title:

Role:

Mr. David J Anderson

Executive VP

Both

Officer/Director:

Title:

Role:

Mr. Joseph P Demanche Executive VP Officer

Officer/Director:

Title:

Role:

Mr. Louis P Maltezos Executive VP Officer

Officer/Director:

Title:

Role:

1020.

Mr. David J Corrsin General Counsel Both

Officer/Director:

Title:

Role:

Mr. John Granara CFO

Officer

Officer/Director:

Title:

Role:

Officer/Director: Title: Role:

Officer/Director:

Mr. Michael T Bakas Sr Vice President Officer

Mr. Douglas I Foy Director

Mr. Thomas S Murley

-3-

Title: Role:

Officer/Director: Ms. Jennifer L Miller

Title:

Role: Director

Officer/Director: Mr. Joseph W Sutton

Title:

Role: Director

Officer/Director: Mr. Frank V Wisneski

Title:

Role: Director

Officer/Director: Ms. Nicole Allen Bulgarino

Title: Sr. Vice President & General Manager
Federal Solutions

Role: Officer

2. Ownership Information

Please provide ownership information concerning each person or entity having a direct or indirect beneficial interest in excess of 7.5% of the Disclosing Party. Examples of such an interest include shares in a corporation, partnership interest in a partnership or joint venture, interest of a member or manager in a limited liability company, or interest of a beneficiary of a trust, estate, or other similar entity. Note: Pursuant to Section 2-154-030 of the Municipal code of Chicago, the City may require any such additional information from any applicant which is reasonably intended to achieve full disclosure.

- Mr. George P Sakellaris - 80% Owner Details

Name

Mr. George P Sakellaris

Address 111 Speen St. Suite 410

Framingham, MA 017 01 United States

-4-

SECTION III -- BUSINESS RELATIONSHIPS WITH CITY ELECTED OFFICIALS

Has the Disclosing Party had a "business relationship," as defined in Chapter 2-156 of the Municipal Code, with any City elected official in the 12 months before the date this EDS is signed?

No

SECTION IV -- DISCLOSURE OF SUBCONTRACTORS AND OTHER RETAINED PARTIES

The Disclosing Party must disclose the name and business address of each subcontractor, attorney, lobbyist, accountant, consultant and any other person or entity whom the Disclosing Party has retained or expects to retain in connection with the Matter, as well as the nature of the relationship, and the total amount of the fees paid or estimated to be paid. The Disclosing Party is not required to disclose employees who are paid solely through the Disclosing Party's regular payroll.

"Lobbyist" means any person or entity who undertakes to influence any legislative or administrative action on behalf of any person or entity other than: (1) a not-for-profit entity, on an unpaid basis, or (2) himself.

"Lobbyist" also means any person or entity any part of whose duties as an employee of another includes undertaking to influence any legislative or administrative action.

If the Disclosing Party is uncertain whether a disclosure is required under this Section, the Disclosing Party must either ask the City whether disclosure is required or make the disclosure.

1. Has the Disclosing Party retained any legal entities in connection with the Matter?

Yes

2. List below the names of all legal entities which are retained parties.

FORNAD ENGINEERING, INC

Anticipated/ Retained:

1926 East Ft. Lowell Road SUITE 200
TUSCON, AZ 85719-2391 United States

Subcontractor - non MWDBE

\$32,000

-5-

(\$\$ or %): Estimated/Paid:

Name:

Anticipated/ Retained:

Business Address:

Relationship: Fees

(\$\$ or %): Estimated/Paid:

Estimated

SILVER SPRING NETWORKS Anticipated

555 BROADWAY STREET

REDWOOD CITY, CA REDWOOD CI United States Subcontractor - non MWDBE

Estimated

Name:

Anticipated/ Retained:

Business Address:

Relationship: Fees

(\$\$ or %) : Estimated/Paid:

Lyons View Anticipated

5261 W. HARRISON

CHICAGO, IL 60644 United States Subcontractor - MWDBE

Estimated

Name:

Anticipated/ Retained:

Business Address:

Relationship: Fees

(\$\$ or %) : Estimated/Paid:

Evvari GIS Consulting, Inc Anticipated

3 06 0 University Ave
non MWDBE
SAN DIEGO, CA 92104 United States
Subcontractor

Estimated

Name:

Anticipated/ Retained:

Business Address:

Relationship: Fees

john burns construction company Anticipated

17601 Southwest Hwy
ORLAND PARK, IL 60467 United States Subcontractor - non MWDBE

-6-

(\$\$ or %): Estimated/Paid:

Uturn Data Solutions

Anticipated/ Retained:

401 N Franklin St. Ste 3S
CHICAGO, IL 60654 United States
Subcontractor - non MWDBE

Fees

(\$\$ or %): Estimated/Paid:

3. Has the Disclosing Party retained any persons in connection with the Matter?

No

SECTION V -- CERTIFICATIONS

A. COURT-ORDERED CHILD SUPPORT COMPLIANCE

Under Municipal Code Section 2-92-415, substantial owners of business entities that contract with the City must remain in compliance with their child support obligations throughout the contract's term.

Has any person who directly or indirectly owns 10% or more of the Disclosing Party been declared in arrearage of any child support obligations by any Illinois court of competent jurisdiction?

No

B. FURTHER CERTIFICATIONS

1. Pursuant to Municipal Code Chapter 1-23, Article I ("Article I")(which the Applicant should consult for defined terms (e.g., "doing business") and legal requirements), if the Disclosing Party submitting this EDS is the Applicant and is doing business with the City, then the Disclosing Party certifies as follows:

- i. neither the Applicant nor any controlling person is currently indicted or charged with, or has admitted guilt of, or has ever been convicted of, or placed under supervision for, any criminal offense involving actual, attempted, or conspiracy to commit bribery, theft, fraud, forgery, perjury, dishonesty or deceit against an officer or employee of the City or any sister agency; and

-7-

- ii. the Applicant understands and acknowledges that compliance with Article I is a continuing requirement for doing business with the City.

NOTE: If Article I applies to the Applicant, the permanent compliance timeframe in Article I supersedes some five-year compliance timeframes in certifications 2 and 3 below.

I certify the above to be true

2. The Disclosing Party and, if the Disclosing Party is a legal entity, all of those persons or entities identified in Section II.B.1. of this EDS:

- a. are not presently debarred, suspended, proposed for debarment, declared ineligible or voluntarily excluded from any transactions by any federal, state or local unit of government;
- b. have not, within a five-year period preceding the date of this EDS, been convicted of a criminal offense, adjudged guilty, or had a civil judgment rendered against them in connection with: obtaining, attempting to obtain, or performing a public (federal, state or local) transaction or contract under a public transaction; a violation of federal or state antitrust statutes; fraud; embezzlement; theft; forgery; bribery; falsification or destruction of records; making false statements; or receiving stolen property;
- c. are not presently indicted for, or criminally or civilly charged by, a governmental entity (federal, state or local) with committing any of the offenses set forth in clause B.2.b. of this Section V;
- d. have not, within a five-year period preceding the date of this EDS, had one or more public transactions (federal, state or local) terminated for cause or default; and
- e. have not, within a five-year period preceding the date of this EDS, been convicted, adjudged guilty, or found liable in a civil proceeding, or in any criminal or civil action, including actions concerning environmental violations, instituted by the City or by the federal government, any state, or any other unit

of local government.

I certify the above to be true

3. Neither the Disclosing Party, nor any Contractor, nor any Affiliated Entity of either the Disclosing Party or any Contractor nor any Agents have, during the five years before the date this EDS is signed, or, with respect to a Contractor, an Affiliated Entity, or an Affiliated Entity of a Contractor during the five years before the date of such Contractor's or Affiliated Entity's contract or engagement in connection with the Matter:

- a. bribed or attempted to bribe, or been convicted or adjudged guilty of bribery or attempting to bribe, a public officer or employee of the City, the State of Illinois,

-8-

or any agency of the federal government or of any state or local government in the United States of America, in that officer's or employee's official capacity;

- b. agreed or colluded with other bidders or prospective bidders, or been a party to any such agreement, or been convicted or adjudged guilty of agreement or collusion among bidders or prospective bidders, in restraint of freedom of competition by agreement to bid a fixed price or otherwise; or
- c. made an admission of such conduct described in a. or b. above that is a matter of record, but have not been prosecuted for such conduct; or
- d. violated the provisions of Municipal Code Section 2-92-610 (Living Wage Ordinance).

I certify the above to be true

4. Neither the Disclosing Party, Affiliated Entity or Contractor, or any of their employees, officials, agents or partners, is barred from contracting with any unit of state or local government as a result of engaging in or being convicted of

- bid-rigging in violation of 720 ILCS 5/33E-3;
- bid-rotating in violation of 720 ILCS 5/33E-4; or
- any similar offense of any state or of the United States of America that contains the same elements as the offense of bid-rigging or bid-rotating.

I certify the above to be true

5. Neither the Disclosing Party nor any Affiliated Entity is listed on any of the following lists maintained by the Office of Foreign Assets Control of the U.S. Department of the Treasury or the Bureau of Industry and Security of the U.S. Department of Commerce or their successors: the Specially Designated Nationals List, the Denied Persons List, the Unverified List, the Entity List and the Debarred List.

I certify the above to be true

6. The Disclosing Party understands and shall comply with the applicable requirements of Chapters 2-55 (Legislative Inspector General), Chapter 2-56 (Inspector General) and Chapter 2-156 (Governmental Ethics) of the Municipal Code.

I certify the above to be true

7. To the best of the Disclosing Party's knowledge after reasonable inquiry, the following is a complete list of all current employees of the Disclosing Party who were, at any time during the 12-month period preceding the execution date of this EDS, an employee, or elected or appointed official, of the City of Chicago.

None

-9-

8. To the best of the Disclosing Party's knowledge after reasonable inquiry, the following is a complete list of all gifts that the Disclosing Party has given or caused to be given, at any time during the 12-month period preceding the execution date of this EDS, to an employee, or elected or appointed official, of the City of Chicago. For purposes of this statement, a "gift" does not include: (i) anything made generally available to City employees or to the general public, or (ii) food or drink provided in the course of official City business and having a retail value of less than \$20 per recipient.

None

C. CERTIFICATION OF STATUS AS FINANCIAL INSTITUTION

The Disclosing Party certifies that, as defined in Section 2-32-455(b) of the Municipal Code, the Disclosing Party

is not a "financial institution"

D. CERTIFICATION REGARDING INTEREST IN CITY BUSINESS

Any words or terms that are defined in Chapter 2-156 of the Municipal Code have the same meanings when used in this Part D.

1. In accordance with Section 2-156-110 of the Municipal Code: Does any official or employee of the City have a financial interest in his or her own name or in the name of any other person or entity in the Matter?

No

E. CERTIFICATION REGARDING SLAVERY ERA BUSINESS

If the Disclosing Party cannot make this verification, the Disclosing Party must disclose all required information in the space provided below or in an attachment in the "Additional Info" tab. Failure to comply with these disclosure requirements may make any contract entered into with the City in connection with the Matter voidable by the City:

The Disclosing Party verifies that the Disclosing Party has searched any and all records of the Disclosing Party and any and all predecessor entities regarding records of investments or profits from slavery or slaveholder insurance policies during the slavery era (including insurance policies issued to slaveholders that provided coverage for damage to or injury or death of their slaves), and the Disclosing Party has found no such records. '

I can make the above verification

-10 -

SECTION VI - CERTIFICATIONS FOR FEDERALLY-FUNDED MATTERS

Is the Matter federally funded? For the purposes of this Section VI, tax credits allocated by the City and proceeds of debt obligations of the City are not federal funding.

SECTION VII -- ACKNOWLEDGMENTS, CONTRACT INCORPORATION, COMPLIANCE, PENALTIES, DISCLOSURE

The Disclosing Party understands and agrees that:

- A. The certifications, disclosures, and acknowledgments contained in this EDS will become part of any contract or other agreement between the Applicant and the City in connection with the Matter, whether procurement, City assistance, or other City action, and are material inducements to the City's execution of any contract or taking other action with respect to the Matter. The Disclosing Party understands that it must comply with all statutes, ordinances, and regulations on which this EDS is based.

The City's Governmental Ethics and Campaign Financing Ordinances, Chapters 2-156 and 2-164 of the Municipal Code, impose certain duties and obligations on persons or entities seeking City contracts, work, business, or transactions. A training program is available on line at www.cityofchicago.org/city/en/depts/ethics.html <<http://www.cityofchicago.org/city/en/depts/ethics.html>>, and may also be obtained from the City's Board of Ethics, 740 N. Sedgwick St., Suite 500, Chicago, IL 60610, (312) 744-9660. The Disclosing Party must comply fully with the applicable ordinances.

I acknowledge and consent to the above The Disclosing Party understands and

agrees that:

- C. If the City determines that any information provided in this EDS is false, incomplete or inaccurate, any contract or other agreement in connection with which it is submitted may be rescinded or be void or voidable, and the City may pursue any remedies under the contract or agreement (if not rescinded or void), at law, or in equity, including terminating the Disclosing Party's participation in the Matter and/or declining to allow the Disclosing Party to participate in other transactions with the City. Remedies at law for a false statement of material fact may include incarceration and an award to the City of treble damages.
- D. It is the City's policy to make this document available to the public on its Internet site and/or upon request. Some or all of the information provided on this EDS

-11 -

and any attachments to this EDS may be made available to the public on the Internet, in response to a Freedom of Information Act request, or otherwise. By completing and signing this EDS, the Disclosing Party waives and releases any possible rights or claims which it may have against the City in connection with the public release of information contained in this EDS and also authorizes the City to verify the accuracy of any information submitted in this EDS.

- F The information provided in this EDS must be kept current. In the event of

The information provided in this EDS must be kept current. In the event of changes, the Disclosing Party must supplement this EDS up to the time the City takes action on the Matter. If the Matter is a contract being handled by the City's Department of Procurement Services, the Disclosing Party must update this EDS as the contract requires. NOTE: With respect to Matters subject to Article I of Chapter 1-23 of the Municipal Code (imposing PERMANENT INELIGIBILITY for certain specified offenses), the information provided herein regarding eligibility must be kept current for a longer period, as required by Chapter 1-23 and Section 2-154-020 of the Municipal Code.

I acknowledge and consent to the above The Disclosing Party represents

and warrants that:

F.1. The Disclosing Party is not delinquent in the payment of any tax administered by the Illinois Department of Revenue, nor are the Disclosing Party or its Affiliated Entities delinquent in paying any fine, fee, tax or other charge owed to the City. This includes, but is not limited to, all water charges, sewer charges, license fees, parking tickets, property taxes or sales taxes.

I certify the above to be true

F.2 If the Disclosing Party is the Applicant, the Disclosing Party and its Affiliated Entities will not use, nor permit their subcontractors to use, any facility listed by the U.S. E.P.A. on the federal Excluded Parties List System ("EPLS") maintained by the U.S. General Services Administration.

I certify the above to be true

F.3 If the Disclosing Party is the Applicant, the Disclosing Party will obtain from any contractors/subcontractors hired or to be hired in connection with the Matter certifications equal in form and substance to those in F.1. and F.2. above and will not, without the prior written consent of the City, use any such contractor/subcontractor that does not provide such certifications or that the Disclosing Party has reason to believe has not provided or cannot provide truthful certifications.

I certify the above to be true

-12-

FAMILIAL RELATIONSHIPS WITH ELECTED CITY OFFICIALS AND DEPARTMENT HEADS

This question is to be completed only by (a) the Applicant, and (b) any legal entity which has a direct ownership interest in the Applicant exceeding 7.5 percent. It is not to be completed by any legal entity which has only an indirect ownership interest in the Applicant.

Under Municipal Code Section 2-154-015, the Disclosing Party must disclose whether such Disclosing Party or any "Applicable Party" or any Spouse or Domestic Partner thereof currently has a "familial relationship" with any elected city official or department head. A "familial relationship" exists if, as of the date this EDS is signed, the Disclosing Party or any "Applicable Party" or any Spouse or Domestic Partner thereof is related to the mayor, any alderman, the city clerk, the city treasurer or any city department head as spouse or domestic partner or as any of the following, whether by blood or adoption: parent, child, brother or sister, aunt or uncle, niece or nephew, grandparent, grandchild, father-in-law, mother-in-law, son-in-law, daughter-in-law, stepfather or stepmother, stepson or stepdaughter, stepbrother or stepsister or half-brother or half-sister.

"Applicable Party" means (1) all corporate officers of the Disclosing Party, if the Disclosing Party is a corporation; all partners of the Disclosing Party, if the Disclosing Party is a general partnership; all general partners and limited partners of the Disclosing Party, if the Disclosing Party is a limited partnership; all managers, managing members and members of the Disclosing Party, if the Disclosing Party is a limited liability company; (2) all principal officers of the Disclosing Party; and (3) any person having more than a 7.5 percent ownership interest in the Disclosing Party. "Principal officers" means the president, chief operating officer, executive director, chief financial officer, treasurer or secretary of a legal entity or any person exercising similar authority.

Does the Disclosing Party or any "Applicable Party" or any Spouse or Domestic Partner thereof currently have a "familial relationship" with an elected city official or department head?

No

APPENDIX B - BUILDING CODE SCOFFLAW/PROBLEM LANDLORD CERTIFICATION

Pursuant to Municipal Code Section 2-154-010, is the Applicant or any Owner identified as a building code scofflaw or problem landlord pursuant to Section 2-92-416 of the Municipal Code?

No

-13 -

If the Applicant is a legal entity publicly traded on any exchange, is any officer or director of the Applicant identified as a building code scofflaw or problem landlord pursuant to Section 2-92-416 of the Municipal Code?

No

ADDITIONAL INFO

Please add any additional explanatory information here. If explanation is longer than 1000 characters, you may add an attachment below. Please note that your EDS, including all attachments, becomes available for public viewing upon contract award. Your attachments will be viewable "as is" without manual redaction by the City. You are responsible for redacting any non-public information from your documents before uploading.

List of vendor attachments uploaded by City staff

None .

List of attachments uploaded by vendor

None .

CERTIFICATION

Under penalty of perjury, the person signing below: (1) warrants that he/she is authorized to execute this EDS on behalf of the Disclosing Party, and (2) warrants that all certifications and statements contained in this EDS are true, accurate and complete as of the date furnished to the City.

Is/ 03/28/2017 Ms. Mary Burns Proposal
Coordinator Ameresco, Inc.

This is a printed copy of the Economic Disclosure Statement, the original of which is filed electronically with the City of Chicago. Any alterations must be made electronically, alterations on this printed copy are void and of no effect.

- 14 -

EXHIBIT 5: MBE / WBE COMPLIANCE PLAN See following pages.

M/WBE Compliance Plan

[PROPOSED MBE / WBE COMPLIANCE PLAN SUBJECT TO FINAL APPROVAL BY CITY PRIOR TO CONTRACT EXECUTION.]

<

M/WBE Compliance Plan

SCHEDULE C: MBE/WBE Letter of Intent to Perform as a Subcontractor to the Prime Contractor
FOR CONSTRUCTION PROJECTS ONLY

NOTICE: THIS SCHEDULE MUST BE AUTHORIZED AND SIGNED BY THE MBE/WBE SUBCONTRACTOR FIRM.
FAILURE TO COMPLY MAY RESULT IN THE BID BEING REJECTED AS NON-RESPONSIVE.

Project Name: Chicago smart Lighting Project Specification No.: NA

From: Anchor Staffing, Inc.

(Name of MBEAA/BE Firm)

To: Ameresco, Inc.

(Name of Prime Contractor)

and the City of Chicago.

The MBE or WBE status of the undersigned is confirmed by the attached City of Chicago or Cook County Certification Letter. 100% MBE or WBE participation is credited for the use of a MBE or WBE "manufacturer." 60% participation is credited for the use of a MBE or WBE "regular dealer."

The undersigned is prepared to perform the following services in connection with the above named project/contract. If more space is required to fully describe the MBE or WBE proposed scope of work and/or payment schedule, attach additional sheets as necessary. The description must establish that the undersigned is performing a commercially useful function:

The above described performance is offered for the following price and described terms of payment:

Pav Item NoJDescriDtion -Tkutoefty HeL2>	-	Total t-
leans		

Subtotal: S 603/2^4. 00 Total @ 100%: \$.

Total @ 60% (if the undersigned is performing work as a regular dealer). \$

NOTICE: THIS SCHEDULE AND ATTACHMENTS REQUIRE ORIGINAL SIGNATURES ON EACH PAGE.

(If not the undersigned, signature of person who filled out this Schedule C) (Date)

(Company Name-Please Print)
tof MBEAVBE)

0

tU/n

(Date)

Chicago Infrastructure Trust Chicago Smart
Lighting Project RFP.

Schedule C: MBE/WBE Letter of Intent to Perform as a Subcontractor to the Prime Contractor

Partial Pav Items

For any of the above items that are partial pay items, specifically describe the work and subcontract dollar amount(s)

Pav Item Nd/Description	Quantibii/Unit Price	Tottl
-------------------------	----------------------	-------

1

Subtotal: 5

Total @ 100%: \$

Total @ 60% (if the undersigned is performing work as a regular dealer): \$

SUB-SUBCONTRACTING LEVELS

A zero (0) must be shown in each blank if the MBE or WBE will not be subcontracting any of the work listed or attached to this schedule.

0 % of the dollar value of the MBE or WBE subcontract that will be subcontracted to non MBE/WBE contractors. 0 % of the dollar value of the MBE or WBE subcontract that will be subcontracted to MBE or WBE contractors.

NOTICE: If any of the MBE or WBE scope of work will be subcontracted, list the name of the vendor and attach a brief explanation, description and pay item number of the work that will be subcontracted. MBE/WBE credit will not be given for work subcontracted to Non-MBE/WBE contractors, except for as allowed in the Special Conditions Regarding Minority Business Enterprise Commitment and Women Business Enterprise Commitment in Construction Contracts.

The undersigned will enter into a formal written agreement for the above work with you as a Prime Contractor, conditioned upon your execution of a contract with the City of Chicago, within three (3) business days of your receipt of a signed contract from the City of Chicago.

The undersigned has entered into a formal written mentor protege agreement as a subcontractor/protege with you as a Prime

The undersigned has entered into a formal written mentor-protégé agreement as a subcontractor/protégé with you as a prime Contractor/mentor. () Yes (X) No

NOTICE. THIS SCHEDULE AND ATTACHMENTS REQUIRE ORIGINAL SIGNATURES ON EACH PAGE.

(If not the undersigned, signature of person who filled out this Schedule C) (Date)

(Name/Title-Please Print)

(Company Name-Please Print)

(Email & Phone Number)



(signature of Kresiaem/uwner/cjEU or Authorized Aagent of (Name/Title-Please Print) /

tjoknsoA 6)M/Jto/dtL\$tia fort /ll£)ffll - (&3&

<^mail & Phone Number) 1/

Chicago Infrastructure Trust | Chicago Smart Lighting Project
RFP - UkL-iuknn

Department of Procurement Services CITY OF
CHICAGO

APR 15 2015

Joyce Johnson
Anchor Staffing, Inc.
9901 South Western Avenue, Suite 206
Chicago, IL 60643-1800

Dear Joyce Johnson:

We are pleased to inform you that Anchor Staffing, Inc. has been recertified as a Minority Business Enterprise ("MBE") and Women Business Enterprise ("WBE") by the City of Chicago ("City"). This MBE/WBE certification is valid until 07/15/2017; however your firm's certification must be revalidated annually. In the past the City has provided you with an annual letter confirming your certification; such letters will no longer be issued. As a consequence, we require you to be even more diligent in filing your annual No-Change Affidavit 60 days before your annual anniversary date.

It is now your responsibility to check the City's certification directory and verify your certification status. As a condition of continued certification during the five year period stated above, you must file an annual No-Change Affidavit. Your firm's annual No-Change Affidavit is due by 07/15/2016. Please remember, you have an affirmative duty to file your No-Change Affidavit 60 days prior to the date of expiration. Failure to file your annual No-Change Affidavit may result in the suspension or rescission of your certification.

Your firm's five year certification will expire on 07/15/2017. You have an affirmative duty to file for recertification 60 days prior to the date of the five year anniversary date. Therefore, you must file for recertification by 05/15/2017.

It is important to note that you also have an ongoing affirmative duty to notify the City of any changes in ownership or control of your firm, or any other fact affecting your firm's eligibility for certification within 10 days of such change. These changes may include but are not limited to a change of address, change of business structure, change in ownership or ownership structure, change of business operations, gross receipts and or personal net worth that exceed the program threshold. Failure to provide the City with timely notice of such changes may result in the suspension or rescission of your certification. In addition, you may be liable for civil penalties under Chapter 1-22, "False Claims", of the Municipal Code of Chicago.

Please note - you shall be deemed to have had your certification lapse and will be ineligible to participate as a MBE/WBE if you fail to:

- File your annual No-Change Affidavit within the required time period;

121 NORTH LASALLE STREET, ROOM 806, CHICAGO, ILLINOIS 60602

Anchor Staffing, Inc.

- Provide financial or other records requested pursuant to an audit within the required time period;
- Notify the City of any changes affecting your firm's certification within 10 days of such change; or
- File your recertification within the required time period.

Please be reminded of your contractual obligation to cooperate with the City with respect to any reviews, audits or investigation of its contracts and affirmative action programs. We strongly encourage you to assist us in maintaining the integrity of our programs by reporting instances or suspicions of fraud or abuse to the City's Inspector General at chicagoinspectorgeneral.org <<http://chicagoinspectorgeneral.org>>, or 866-IG-TIPLINE (866-448-4754).

Be advised that if you or your firm is found to be involved in certification, bidding and/or contractual fraud or abuse, the City will pursue decertification and debarment. In addition to any other penalty imposed by law, any person who knowingly obtains, or knowingly assists another in obtaining a contract with the City by falsely representing the individual or entity, or the individual or entity assisted is guilty of a misdemeanor, punishable by incarceration in the county jail for a period not to exceed six months, or a fine of not less than \$5,000 and not more than \$10,000 or both.

Your firm's name will be listed in the City's Directory of Minority and Women-Owned Business Enterprises in the specialty area(s) of:

**NAICS Code(s):
561311 - Employment placement agencies or services 561320 -
Temporary employment services**

Your firm's participation on City contracts will be credited only toward Minority Business Enterprise and Women Business Enterprise goals in your area(s) specialty. While your participation on City contracts is not limited to your area of specialty, credit toward goals will be given only for work that is self-performed and providing a commercially useful function that is done in the approved specialty category.

Thank you for your interest in the City's Minority and Women-Owned Business Enterprise (MBE/WBE) Program.

Sincerely,

Jamie L Rhee Cwef Procurement Officer

JLR/sl

SCHEDULE C: MBE/WBE Letter of Intent to Perform as a Subcontractor to the Prime Contractor FOR CONSTRUCTION PROJECTS ONLY

NOTICE: THIS SCHEDULE MUST BE AUTHORIZED AND SIGNED BY THE MBE/WBE SUBCONTRACTOR FIRM. FAILURE TO COMPLY MAY RESULT IN THE BID BEING REJECTED AS NON-RESPONSIVE.

Project Name: Chicago Smart Lighting Project Specification No.: NA

From: DSR Group. Inc.
(Name of MBE/WBE Firm)

To: Ameresco, Inc. and the City of Chicago.
(Name of Prime Contractor)

The MBE or WBE status of the undersigned is confirmed by the attached City of Chicago or Cook County Certification Letter. 100% MBE or WBE participation is credited for the use of a MBE or WBE "manufacturer." 60% participation is credited for the use of a MBE or WBE "regular dealer."

The undersigned is prepared to perform the following services in connection with the above named project/contract. If more space is required to fully describe the MBE or WBE proposed scope of work and/or payment schedule, attach additional sheets as necessary. The description must establish that the undersigned is performing a commercially useful function:

Project management.

The above described performance is offered for the following price and described terms of payment:

Pav Item No./Description	Quantity/Unit Price	Total
--------------------------	---------------------	-------

Subtotal: \$. Total @ 100%: \$.

Total @ 60% (if the undersigned is performing work as a regular dealer): \$

NOTICE: THIS SCHEDULE AND ATTACHMENTS REQUIRE ORIGINAL SIGNATURES ON EACH PAGE.

(Name/Title) (If not the undersigned, signature of person who filled out this Schedule C) (Date)

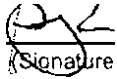
(Signature)

e-Please Print)

(Company Name-Please Print)

of President/Owner/CEO or Authorized Agent of MBE/WBE) (Date)

Benjamin Reyes, President

(Name/Title-Please Print)

Chicago Infrastructure Trust

Chicago Smart Lighting Project RFP - Addendum #2

Schedule C: MBE/WBE Letter of Intent to Perform as a Subcontractor to the Prime Contractor

Partial Pay Items

For any of the above items that are partial pay items, specifically describe the work and subcontract dollar amount(s):

Pav Item No./Description	Quantity/Unit Price	Total
--------------------------	---------------------	-------

Subtotal: S.

Total @ 100%: \$

Total @ 60% (if the undersigned is performing work as a regular dealer): S

SUB-SUBCONTRACTING LEVELS

A zero (0) must be shown in each blank if the MBE or WBE will not be subcontracting any of the work listed or attached to this schedule.

% of the dollar value of the MBE or WBE subcontract that will be subcontracted to non MBE/WBE contractors.

% of the dollar value of the MBE or WBE subcontract that will be subcontracted to MBE or WBE contractors.

NOTICE: If any of the MBE or WBE scope of work will be subcontracted, list the name of the vendor and attach a brief explanation, description and pay item number of the work that will be subcontracted. MBE/WBE credit will not be given for work subcontracted to Non-MBE/WBE contractors, except for as allowed in the Special Conditions Regarding Minority Business Enterprise Commitment and Women Business Enterprise Commitment in Construction Contracts.

The undersigned will enter into a formal written agreement for the above work with you as a Prime Contractor, conditioned upon your execution of a contract with the City of Chicago, within three (3) business days of your receipt of a signed contract from the City of Chicago.

The undersigned has entered into a formal written mentor protege agreement as a subcontractor/protege with you as a Prime Contractor/mentor. ()
Yes () No

NOTICE: THIS SCHEDULE AND ATTACHMENTS REQUIRE ORIGINAL SIGNATURES ON EACH PAGE.

(If not the undersigned, signature of person who filled out this Schedule C) (Date)

(Name/Title-Please Print)

(Company Name-Please Print)

(Signature of President/Owner/CEO or Authorized Agent of MBE/WBE) (Date)

rrwt>\ r

Benjamin Reyes. President

(Name/Title-Please Print)

myesfifi21 (Smsn.rinm)

(Email & Phone Number)

Chicago Infrastructure Trust
Chicago Smart Lighting Project RFP - Addendum #2

Department of Procurement Services
CITY OF CHICAGO

DSR Group, Inc.
1234 S. Michigan Ave. Suite C

Chicago, IL 60605 Dear Mr. Reyes:

We are pleased to inform you that DSR Group, Inc. has been recertified as a Minority Business Enterprise (MBE) by the City of Chicago ("Crty"). This MBE certification is valid until 11/30/18; however, your firm's certification must be revalidated annually. In the past, the City has provided you with an annual letter confirming your certification; such letters will no longer be issued. As a consequence, we require you to be even more diligent in filing your annual No-Change Affidavit 60 days before your annual anniversary date.

It is now your responsibility to check the City's certification directory and verify your certification status. As a condition of continued certification during the five-year period stated above, you must file an annual No-Change Affidavit. Your firm's annual No-Change Affidavit is due by 11/30/2014, 11/30/2015, 11/30/2016, and 11/30/2017. Please remember, you have an affirmative duty to file your No-Change Affidavit 60 days prior to the date of expiration. Failure to file your annual No-Change Affidavit may result in the suspension or rescission of your certification.

Your firm's five-year certification will expire on 11/30/2018. You have an affirmative duty to file for recertification 60 days prior to the date of the five-year anniversary date. Therefore, you must file for recertification by 09/30/2018.

It is important to note that you also have an ongoing affirmative duty to notify the City of any changes in ownership or control of your firm, or any other fact affecting your firm's eligibility for certification within 10 days of such change. These changes may include but are not limited to a change of address, change of business structure, change in ownership or ownership structure, change of business operations, gross receipts and or personal net worth that exceed the program threshold. Failure to provide the City with timely notice of such changes may result in the suspension or rescission of your certification. In addition, you may be liable for civil penalties under Chapter 1-22, "False Claims", of the Municipal Code of Chicago.

Please note - you shall be deemed to have had your certification lapse and will be ineligible to participate as a MBE if you fail to:

- o File your annual No-Change Affidavit within the required time period;
- o Provide financial or other records requested pursuant to an audit within the required time period;

121 NORTH LASALLE STREET, ROOM 806, CHICAGO ILLINOIS 60602

DSR Group, Inc.

- <> Notify the City of any changes affecting your firm's certification within 10 days of such change; or
- o File your recertification within the required time period.

Please be reminded of your contractual obligation to cooperate with the City with respect to any reviews, audits or investigation of its contracts and affirmative action programs. We strongly encourage you to assist us in maintaining the integrity of our programs by reporting instances or suspicions of fraud or abuse to the City's Inspector General at chicagoinspectorgeneral.org <<http://chicagoinspectorgeneral.org>>, or 866-IG-TIPLINE (866-448-4754).

Be advised that if you or your firm is found to be involved in certification, bidding and/or contractual fraud or abuse, the City will pursue decertification and debarment. In addition to any other penalty imposed by law, any person who knowingly obtains, or knowingly assists another in obtaining a contract with the City by falsely representing the individual or entity, or the individual or entity assisted is guilty of a misdemeanor, punishable by incarceration in the county jail for a period not to exceed six months, or a fine of not less than \$5,000 and not more than \$10,000 or both.

Your firm's name will be listed in the City's Directory of Minority and Women-Owned Business Enterprises in the specialty area(s) of:

NAICS Code(s):

238130 - Carpentry, Framing

238350 - Trim and Finish Carpentry Contractors

1 - Construction management, Single-Family Building

2 - Construction Management, Multi-Family Building 236118 -

Construction management, Residential Remodeling

236210 - Construction management, Industrial Building (except warehouses) 236220 -

Construction Management, Commercial and Institutional Building

Your firm's participation on City contracts will be credited only toward Minority Business Enterprise goals in your area(s) specialty. While your participation on City contracts is not limited to your area of specialty, credit toward goals will be given only for work that is self-performed and providing a commercially useful function that is done in the approved specialty category.

Thank you for your interest in the City's Minority Business Enterprise (MBE) Program.

Sincerely,)

Jamie L.-Rheey,
Chief Procurement Officer

JLR/ta

**SCHEDULE C: MBE/WBE Letter of Intent to Perform as a Subcontractor to the Prime Contractor
FOR**

CONSTRUCTION PROJECTS ONLY

NOTICE: THIS SCHEDULE MUST BE AUTHORIZED AND SIGNED BY THE MBE/WBE SUBCONTRACTOR FIRM. FAILURE TO COMPLY MAY RESULT IN THE BID BEING REJECTED AS NON-RESPONSIVE.

Project Name: CIT Smart Street Lighting Specification No.:
Prov Lyons View Manufacturing and Supply
(Name of MBE/WBE Firm)
To: Ameresco, Inc and the City of Chicago.
(Name of Prime Contractor)

The MBE or WBE status of the undersigned is confirmed by the attached City of Chicago or Cook County Certification Letter. 100% MBE or WBE participation is credited for the use of a MBE or WBE "manufacturer." 60% participation is credited for the use of a MBE or WBE "regular dealer."

The undersigned is prepared to perform the following services in connection with the above named project/contract. If more space is required to fully describe the MBE or WBE proposed scope of work and/or payment schedule, attach additional sheets as necessary. The description must establish that the undersigned is performing a commercially useful function:

Provide local assembly of applicable lighting fixtures and material for The Chicago Smart Lighting Project

The above described performance is offered for the following price and described terms of payment:

Pav Item No./Description	Quantity/Unit Price	Total
LED Lighting Fixtures and Material	-	See attached

Subtotal: \$
32,793,090. *>

Total @ 100%: \$
5g, 793,090.⁰⁹

Total @ 60% (if the undersigned is performing work as a regular dealer): \$

NOTICE: THIS SCHEDULE AND ATTACHMENTS REQUIRE ORIGINAL SIGNATURES ON EACH PAGE.

(If not the undersigned, signature of person who filled out this Schedule C)

(Name/Title-Please Print)

(Company Name-Please Print) 3-28-17
(Signature of President/Owner/CEO or Authorized Agent of MBE/WBE)
Joshua Davis, President

Chicago Infrastructure Trust Chicago Smart Lighting Project
RIP.

Schedule C: MBE/WBE Letter of Intent to Perform as a Subcontractor to the Prime Contractor

Partial Pay Items

For any of the above items that are partial .pay items, specifically describe the work and subcontract dollar amount(s):

Pav Item No./Description	Quantity/Unit Price	Total
--------------------------	---------------------	-------

Subtotal: \$

Total @ 100%: \$

Total @ 60% (if the undersigned is performing work as a regular dealer): \$

SUB-SUBCONTRACTING LEVELS

A zero (0) must be shown in each blank if the MBE or WBE will not be subcontracting any of the work listed or attached to this schedule.
% of the dollar value of the MBE or WBE subcontract that will be subcontracted to non MBE/WBE contractors.
% of the dollar value of the MBE or WBE subcontract that will be subcontracted to MBE or WBE contractors.

NOTICE: If any of the MBE or WBE scope of work will be subcontracted, list the name of the vendor and attach a brief explanation, description and pay item number of the work that will be subcontracted. MBE/WBE credit will not be given for work subcontracted to Non-MBE/WBE contractors, except for as allowed in the Special Conditions Regarding Minority Business Enterprise Commitment and Women Business Enterprise Commitment in Construction Contracts.

The undersigned will enter into a formal written agreement for the above work with you as a Prime Contractor, conditioned upon your execution of a contract with the City of Chicago, within three (3) business days of your receipt of a signed contract from the City of Chicago.

The undersigned has entered into a formal written mentor protege agreement as a subcontractor/protege with you as a Prime Contractor/mentor.
(Yes () No

NOTICE: THIS SCHEDULE AND ATTACHMENTS REQUIRE ORIGINAL SIGNATURES ON EACH PAGE.

(If not the undersigned, signature of person who filled out this Schedule C) (Date)

(Name/Title-Please Print)

(Company Name-Please Print)

(Email & Phone Number)

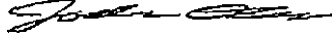

(Signature of President/Owner/CEO or Authorized Agent of MBE/WBE) (Date) Joshua Davis, President (Name/Title-Please Print) jdavis@lyonsviewmfg.com <mailto:jdavis@lyonsviewmfg.com> 630-536-7985

(Email & Phone Number)

Department of Procurement Services

CITY OF CHICAGO

APR 4 2016

Mr. Joshua S. Davis Lyons View Manufacturer
& Supply, Inc. 5261 West Harrison Street
Chicago, IL 60644

Dear Joshua S. Davis:

We are pleased to inform you that Lyons View Manufacturer & Supply, Inc., has been certified as a Minority-Owned Business Enterprise ("MBE") by the City of Chicago ("City"). This MBE certification is valid until 04/01/2021; however your firm's certification must be revalidated annually. In the past the City has provided you with an annual letter confirming your certification; such letters will no longer be issued. As a consequence, we require you to be even more diligent in filing your annual No-Change Affidavit 60 days before your annual anniversary date.

It is now your responsibility to check the City's certification directory and verify your certification status. As a condition of continued certification during the five year period stated above, you must file an annual No-Change Affidavit. Your firm's annual No-Change Affidavit is due by 04/01/2017, 04/01/2018, 04/01/2019, and 04/01/2020. Please remember, you have an affirmative duty to file your No-Change Affidavit 60 days prior to the date of expiration. Failure to file your annual No-Change Affidavit may result in the suspension or rescission of your certification.

Your firm's five year certification will expire on 04/01/2021. You have an affirmative duty to file for recertification 60 days prior to the date of the five year anniversary date. Therefore, you must file for recertification by 02/01/2021.

It is important to note that you also have an ongoing affirmative duty to notify the City of any changes in ownership or control of your firm, or any other fact affecting your firm's eligibility for certification within 10 days of such change. These changes may include but are not limited to a change of address, change of business structure, change in ownership or ownership structure, change of business operations, gross receipts and or personal net worth that exceed the program threshold. Failure to provide the City with timely notice of such changes may result in the suspension or rescission of your certification. In addition, you may be liable for civil penalties under Chapter 1-22, "False Claims", of the Municipal Code of Chicago. rTX~



121 NORTH LASALLE STREET, ROOM 806, CHICAGO, ILLINOIS 60602

Lyons View Manufacturer & Supply, Inc.

Please note - you shall be deemed to have had your certification lapse and will be ineligible to participate as a MBE if you fail to:

- File your annual No-Change Affidavit within the required time period;
- Provide financial or other records requested pursuant to an audit within the required time period;
- Notify the City of any changes affecting your firm's certification within 10 days of such change; or
- File your recertification within the required time period.

Please be reminded of your contractual obligation to cooperate with the City with respect to any reviews, audits or investigation of its contracts and affirmative action programs. We strongly encourage you to assist us in maintaining the integrity of our programs by reporting instances or suspicions of fraud or abuse to the City's Inspector General at chicagoinspectorgeneral.org <<http://chicagoinspectorgeneral.org>>, or 866-IG-TIPLINE (866-448-4754).

Be advised that if you or your firm is found to be involved in certification, bidding and/or contractual fraud or abuse, the City will pursue decertification and debarment. In addition to any other penalty imposed by law, any person who knowingly obtains, or knowingly assists another in obtaining a contract with the City by falsely representing the individual or entity, or the individual or entity assisted is guilty of a misdemeanor, punishable

by incarceration in the county jail for a period not to exceed six months, or a fine of not less than \$5,000 and not more than \$10,000 or both.

Your firm's name will be listed in the City's Directory of Minority and Women-Owned Business Enterprises in the specialty area(s) of:

NAICS Code(s):

335129 - Other Lighting Equipment Manufacturing

423610 - Electrical Apparatus/Equipment/Wiring Supplies Wholesalers

Your firm's participation on City contracts will be credited only toward Minority-Owned Business Enterprise goals in your area(s) specialty. While your participation on City contracts is not limited to your area of specialty, credit toward goals will be given only for work that is self-performed and providing a commercially useful function that is done in the approved specialty category.

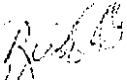

Rich Butler

First Deputy Procurement Officer RB/cm

Thank you for your interest in the City's Minority Business Enterprise (MBE) Program. Sincerely,

SCHEDULE C (Construction): MBE/WBE Letter of Intent to Perform as a SUPPLIER

Project Name: Chicago Smart Lighting

Specification Number: NA

From- Evergreen Supply Co.

(Name of MBE or WBE Firm)

To Ameresco, Inc.

(Name of Prime Contractor)

and the City of Chicago

The MBE or WBE status of the undersigned is confirmed by the attached City of Chicago or Cook County Certification Letter. 100% MBE or WBE participation is credited for the use of a MBE or WBE "manufacturer". 60% participation is credited for the use of a MBE or WBE "regular dealer".

The undersigned is prepared to supply the following goods in connection with the above named project/contract On a separate sheet, fully describe the MBE or WBE proposed scope of work and/or payment schedule, including a description of the commercially useful function being performed. Attach additional:sheets as necessary:

Pay Item No. / Description	Quantity/ Unit Price	^Tot31,
a 7, J, i, _ j	_ ' , . . " , j	See Attached
..See Attached	See Attached	_ .

Line 1: Sub Total: S

Line 2: Total @ 100% s See Attached

Line 3: Total© 60%. s See Attached

Partial Pav Items.

For any of the above items that are partial pay items, specifically describe the work and subcontract dollar amount(s):

Pay Item No. / Description	Quantity / Unit Price Total
----------------------------	-----------------------------

1)

Line 1: Sub Total: Line 2: Total @ 100%. Line 3:

Total @ 60%:

SUB-SUBCONTRACTING LEVELS - A zero (0) must be shown in each blank if the MBE or WBE will not be subcontracting any of the work listed or attached to this schedule.

0 % of the dollar value of the MBE or WBE subcontract that will be subcontracted to non-MBE/WBE contractors.

0 % of the dollar value of the MBE or WBE subcontract that will be subcontracted to MBE or WBE contractors

NOTICE: If any of the MBE or WBE scope of work will be subcontracted, list the name of the vendor and attach a brief explanation, description and pay item number of the work that will be subcontracted. MBE/WBE credit will not be given for work subcontracted to non-MBE/WBE contractors, except for as allowed in the Special Conditions Regarding Minority Business Enterprise Commitment and Women Business Enterprise Commitment in Construction Contracts.

The undersigned will enter into a formal written agreement for the above work with you as a Prime Contractor, conditioned upon your execution of a contract with the City of Chicago, within three (3) business days of your receipt of a signed contract from the City of Chicago

The undersigned has entered into a formal written mentor protege agreement as a subcontractor/protege with you as a Prime Contractor/raeritor: (,) Ye& (X) No

NOTICE: THIS AND ATTACHMENTS REQUIRE ORIGINAL SIGNATURES.

President

<2^ 12/16/2016

Colleen Kramer
773-375-4750 ckramer@cvergreensupply.com <mailto:ckramer@cvergreensupply.com>

1)

diilL!^! Lih,i^Hl<liic l itisl
(tiic:i^c Sni;irl Li^hlin^ Pnij;:ul Kl i' < "k'iu";,m ;J

TOTAL	W	W	W	W	W	W	W	W	\$
8,477									8,477
532									532
00									00
WB									WB VALU
PAR									PAR E @
TIC									TICIP80%:
AT									ATIO
N									N
(E									(EVE
R									RGR
E									EEN
S									SUP
P									PLY):

BID	QTY	EA	EA	EAC	EA	EA	EA	EA	EA	EAC	EAC	EAC	EAC	EAC	EAC	EAC
U		EA	EA	EAC	EA	EA	EA	EA	EA	EAC	EAC	EAC	EAC	EAC	EAC	EAC
M		CH	CH	H	CH	CH	CH	CH	CH	H	H	H	H	H	H	H
DES		Re	Alle	Alle	Art	Re	Art	Art	Re	Viad	Re	Art	Par	Par	Lu	Lu
CRIP		sid	v	v	eriasid	eriasid	eriasid	eriasid	eriasid	uct	sid	erik	k	min	min	min

entil PatPat aireaire
 al Ac hw hw No No
 LegWirng edeMo rge edi Inte
 Co orn ay ay de de -
 ach| Co Sh - Inte
 | bra oebExt rnal
 heaox |ern
 d| al
 ' |
 RO s) | Fo ot ot ot Fo
 W, ot RO RO RO ot
 On ROW, W, W, RO
 e- W, Sta Op Sta W,
 Sid On ggeposgge45
 ed e- red ite red De
 Lig Sid Lig Lig Lig gre
 ht ed ht ht ht e
 Pol Lig Pol Pol Pol An
 e ht e e e gle)
 Co Pol Co Co Co |
 nfig e nfignfignfig
 ura Co ura ura ura
 tion nfigtiontiontion
)| ura)|)|)|
 tion
)|
)|
 ITEM m <3- LO ID 00 o ,1-1-1 nNHH m u
 it

Department of Procurement Services
CITY OF CHICAGO

1)
MAR] 0 2014

Ms. Colleen Kramer Evergreen Supply Co. 9901
S. Torrence Ave. Chicago, IL 60617

Dear Ms. Kramer:

We are pleased to inform you that Evergreen Supply Co., has been recertified as a Women Business Enterprise ("WBE") by the City of Chicago ("City"). This WBE certification is valid until 2/1/2018; however your firm's certification must be revalidated annually. In the past the City has provided you with an annual letter confirming your certification; such letters will no longer be issued. As a consequence, we require you to be even more diligent in filing your annual No-Change Affidavit 60 days before your annual anniversary date.

It is now your responsibility to check the City's certification directory and verify your certification status. As a condition of continued certification during the five year period stated above, you must file an annual No-Change Affidavit. Your firm's annual No-Change Affidavit is due by 2/1/2015, 2/1/2016 and 2/1/2017. Please remember, you have an affirmative duty to file your No-Change Affidavit 60 days prior to the date of expiration. Failure to file your annual No-Change Affidavit may result in the suspension or rescission of your certification.

Your firm's five year certification will expire on 2/1/2018. You have an affirmative duty to file for recertification 60 days prior to the date of the five year anniversary date. Therefore, you must file for recertification by 12/1/2017.

It is important to note that you also have an ongoing affirmative duty to notify the City of any changes in ownership or control of your firm, or any other fact affecting your firm's eligibility for certification within 10 days of such change. These changes may include but are not limited to a change of address, change of business structure, change in ownership or ownership structure, change of business operations, gross receipts and or personal net worth that exceed the program threshold. Failure to provide the City with timely notice of such changes may result in the suspension or rescission of your certification. In addition, you may be liable for civil penalties under Chapter 1-22, "False Claims", of the Municipal Code of Chicago.

Please note - you shall be deemed to have had your certification lapse and will be ineligible to participate as a WBE if you fail to:

121 NORTH LASALLE STREET. ROOM 80(3), CHICAGO ILLINOIS 60602

Evergreen Supply Co.

- File your annual No-Change Affidavit within the required time period;
- Provide financial or other records requested pursuant to an audit within the required time period;
- Notify the City of any changes affecting your firm's certification within 10 days of such change; or
- File your recertification within the required time period.

Please be reminded of your contractual obligation to cooperate with the City with respect to any reviews, audits or investigation of its contracts and affirmative action programs. We strongly encourage you to assist us in maintaining the integrity of our programs by reporting instances or suspicions of fraud or abuse to the City's Inspector General at chicagoinspectorgeneral.org <<http://chicagoinspectorgeneral.org>>, or 866-IG-TIPLINE (866-448-4754).

Be advised that if you or your firm is found to be involved in certification, bidding and/or contractual fraud or abuse, the City will pursue decertification and debarment. In addition to any other penalty imposed by law, any person who knowingly obtains, or knowingly assists another in obtaining a contract with the City by falsely representing the individual or entity, or the individual or entity assisted is guilty of a misdemeanor, punishable by incarceration in the county jail for a period not to exceed six months, or a fine of not less than \$5,000 and not more than \$10,000 or both.

Your firm's name will be listed in the City's Directory of Minority and Women-Owned Business Enterprises in the specialty area(s) of:

NAICS Code(s):

423610 - Construction Materials, Electrical Merchant Wholesalers 423610- Fixtures, Electric Lighting, Merchant Wholesalers 423610-Insulated Wire or Cable Merchant Wholesalers 423690 - Condensers, Electronic, Merchant Wholesalers
423690 - Electronic Parts (e.g., condensers, connectors, switches) Merchant Wholesalers

Your firm's participation on City contracts will be credited only toward Women Business Enterprise goals in your area (s) specialty. While your participation on City contracts is not limited to your area of specialty, credit toward goals will be given only for work that is self-performed and providing a commercially useful function that is done in the approved specialty category.

Thank you for your interest in the City's Women-Owned Business Enterprise (WBE) Program.

JLR/cm

Sincerely,

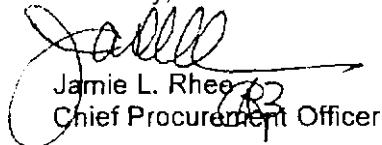
Jamie L. Rhee
Chief Procurement Officer



1)

FOR CONSTRUCTION

SCHEDULE C: MBE/WBE Letter of Intent to Perform as a PROJECTS ONLY 2nd Tier Subcontractor to the Prime Contractor

NOTICE: THIS SCHEDULE MUST BE AUTHORIZED AND SIGNED BY THE MBE/WBE SUBCONTRACTOR FIRM. FAILURE TO COMPLY MAY RESULT IN THE BID BEING REJECTED AS NON-RESPONSIVE.

Project Name: Chicago smart Lighting Project Specification No.: NA

From: Horizon Contractors Inc.
(Name of MBE/WBE Firm)
To: John Burns Construction Co.
(Name of 1st Tier Contractor)

To: Ameresco, Inc. i and the City of Chicago.
(Name of Prime Contractor)

The MBE or WBE status of the undersigned is confirmed by the attached City of Chicago or Cook County Certification Letter. 100% MBE or WBE participation is credited for the use of a MBE or WBE "manufacturer." 60% participation is credited for the use of a MBE or WBE "regular dealer."

The undersigned is prepared to perform the following services in connection with the above named project/contract. If more space is required to fully describe the MBE or WBE proposed scope of work and/or payment schedule, attach additional sheets as necessary. The description must establish that the undersigned is performing a commercially useful function:

WBE Electrical Subcontractor

The above described performance is offered for the following price and described terms of payment:

Pav Item No./Description	Quantity/Unit Price	Total
See Attached	See Attached	See Attached

Subtotal: \$ See Attached

Total @ 100%: \$ See Attached

Total @ 60% (if the undersigned is performing work as a regular dealer): \$ _

NOTICE: THIS SCHEDULE AND ATTACHMENTS REQUIRE ORIGINAL SIGNATURES ON EACH PAGE.

(If not the undersigned, signature of person who filled out this Schedule C)

(Company Name-Please Print)

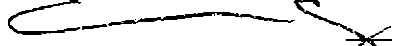

(Signature of President/Owner/CEO or Authorized Agent of MBE/WBE)

(Name/Title-Please Print)

- 1)
- 2)

Chicago Infrastructure Trust Chicago Smart Lighting Project RKL' .

Schedule C: MBE/WBE Letter of Intent to Perform as a 2nd Tier Subcontractor to the Prime Contractor Partial Pay

Items

Pav Item No./Description	Quantity/Unit Price	Total
--------------------------	---------------------	-------

Subtotal: \$ _ Total @ 100%: \$ _

Total @ 60% (if the undersigned is performing work as a regular dealer): \$ _

SUB-SUBCONTRACTING LEVELS

A zero (0) must be shown in each blank if the MBE or WBE will not be subcontracting any of the work listed or attached to this schedule.

-- 0- % of the dollar value of the MBE or WBE subcontract that will be subcontracted to non MBE/WBE contractors. 0 ■ % of the dollar value of the MBE or WBE subcontract that will be subcontracted to MBE or WBE contractors.

NOTICE: If any of the MBE or WBE scope of work will be subcontracted, list the name of the vendor and attach a brief explanation, description and pay item number of the work that will be subcontracted. MBE/WBE credit will not be given for work subcontracted to Non-MBE/WBE contractors, except for as allowed in the Special Conditions Regarding Minority Business Enterprise Commitment and Women Business Enterprise Commitment in Construction Contracts.

The undersigned will enter into a formal written agreement for the above work with you as a Prime Contractor, conditioned upon your execution of a contract with the City of Chicago, within three (3) business days of your receipt of a signed contract from the City of Chicago.

The undersigned has entered into a formal written mentor protege agreement as a subcontractor/protege with you as a Prime Contractor/mentor- () Yes (x) No

NOTICE: THIS SCHEDULE AND ATTACHMENTS REQUIRE ORIGINAL SIGNATURES ON EACH PAGE.

(If not the undersigned, signature of person who filled out this Schedule C) (Date)

(Name/Title-Please Print)

(Company Name-Please Print)

(Email & Phone Number)

(Signature of President/Owner/CEC^or Authorized Agent of MBE/WBE) (Date)

(Name/Title-Please

Print)

(Email

&

Phone Number)

- 1)
- 2)
- 3)

Chicago Infrastructure Truil
Chicago Smart Lighting Project KKI> -■ \dJoinlimi <file:///dJoinlimi> ³.

TO \$ \$
104.9104.9
TAL 51.6051.60
| | |
UNIT \$ WBE
PRIC 322.9PART
E 3 ICIPA
TION
(HOR
IZON
CON
TRA
CTO
RS):
BID 325.0
QTY 0
U EAC
H
M
DES Alle
CRIP
TION^Y
(Exi
stin
g
Wiri
ng
Har
nes
s)
m

Department of Procurement Services CITY OF CHICAGO

Ms. Christine Chung-Hurley Horizon
Contractors, Inc. 712 West Root Street
Chicago, IL 60609

Dear Ms. Chung-Hurley:

We are pleased to inform you that Horizon Contractors, Inc., has been recertified as a Minority Business Enterprise ("MBE") and Women Business Enterprise ("WBE") by the City of Chicago ("City"). This MBE/WBE certification is valid until 1/1/2018; however your firm's certification must be revalidated annually. In the past the City has provided you with an annual letter confirming your certification; such letters will no longer be issued. As a consequence, we require you to be even more diligent in filing your annual No-Change Affidavit 60 days before your annual anniversary date.

It is now your responsibility to check the City's certification directory and verify your certification status. As a condition of continued certification during the five year period stated above, you must file an annual No-Change Affidavit. Your firm's annual No-Change Affidavit is due by 1/1/2015, 1/1/2016, and 1/1/2017. Please remember, you have an affirmative duty to file your No-Change Affidavit 60 days prior to the date of expiration. Failure to file your annual No-Change Affidavit may result in the suspension or rescission of your certification.

Your firm's five year certification will expire on 1/1/2018. You have an affirmative duty to file for recertification 60 days prior to the date of the five year anniversary date. Therefore, you must file for recertification by 11/1/2017.

It is important to note that you also have an ongoing affirmative duty to notify the City of any changes in ownership or control of your firm, or any other fact affecting your firm's eligibility for certification within 10 days of such change. These changes may include but are not limited to a change of address, change of business structure, change in ownership or ownership structure, change of business operations, gross receipts and or personal net worth that exceed the program threshold. Failure to provide the City with timely notice of such changes may result in the suspension or rescission of your certification. In addition, you may be liable for civil

penalties under Chapter 1-22, "False Claims", of the Municipal Code of Chicago.

Please note - you shall be deemed to have had your certification lapse and will be ineligible to participate as a MBE/WBE if you fail to:

- File your annual No-Change Affidavit within the required time period;
- Provide financial or other records requested pursuant to an audit within the required time period;

121 NORTH LASALLE STREET, ROOM 806, CHICAGO, ILLINOIS 60602

Horizon Contractors, Inc.

- Notify the City of any changes affecting your firm's certification within 10 days of such change; or
- File your recertification within the required time period.

Please be reminded of your contractual obligation to cooperate with the City with respect to any reviews, audits or investigation of its contracts and affirmative action programs. We strongly encourage you to assist us in maintaining the integrity of our programs by reporting instances or suspicions of fraud or abuse to the City's Inspector General at chicagoinspectorgeneral.org <<http://chicagoinspectorgeneral.org>>, or 866-IG-TIPLINE (866-448-4754).

Be advised that if you or your firm is found to be involved in certification, bidding and/or contractual fraud or abuse, the City will pursue decertification and debarment. In addition to any other penalty imposed by law, any person who knowingly obtains, or knowingly assists another in obtaining a contract with the City by falsely representing the individual or entity, or the individual or entity assisted is guilty of a misdemeanor, punishable by incarceration in the county jail for a period not to exceed six months, or a fine of not less than \$5,000 and not more than \$10,000 or both.

Your firm's name will be listed in the City's Directory of Minority and Women-Owned Business Enterprises in the specialty area(s) of:

**NAICS Code(s):
238210 - Electrical Contractors**

Your firm's participation on City contracts will be credited only toward Minority Business Enterprise and Women Business Enterprise goals in your area(s) specialty. While your participation on City contracts is not limited to your area of specialty, credit toward goals will be given only for work that is self-performed and providing a commercially useful function that is done in the approved specialty category.

Thank you for your interest in the City's Minority and Women-Owned Business Enterprise (MBE/WBE) Program.

Sincerely,



FOR CONSTRUCTION

SCHEDULE C: MBE/WBE Letter of Intent to Perform as a PROJECTS ONLY 2nd Tier Subcontractor to the Prime Contractor

NOTICE: THIS SCHEDULE MUST BE AUTHORIZED AND SIGNED BY THE MBE/WBE SUBCONTRACTOR FIRM. FAILURE TO COMPLY MAY RESULT IN THE BID BEING REJECTED AS NON-RESPONSIVE.

Project Name: Chicago Smart Lighting Project

From: Livewire Electrical Systems, Inc.
(Name of MBE/WBE Firm) John

DUNIS CONSTRUCTION CO.

To: _____
and the City of Chicago.
(Name of 1st Tier Contractor)

To: Ameresco, Inc.
(Name of Prime Contractor)

The MBE or WBE status of the undersigned is confirmed by the attached City of Chicago or Cook County Certification Letter. 100% MBE or WBE participation is credited for the use of a MBE or WBE "manufacturer." 60% participation is credited for the use of a MBE or WBE "regular dealer."

The undersigned is prepared to perform the following services in connection with the above named project/contract. If more space is required to fully describe the MBE or WBE proposed scope of work and/or payment schedule, attach additional sheets as necessary. The description must establish that the undersigned is performing a commercially useful function:

MBE Electrical Subcontractor

The above described performance is offered for the following price and described terms of payment:

Pav Item No./Description	Quantity/Unit Price	Total
See Attached	See Attached	See Attached

Subtotal: \$ See Attached Total @ 100%: \$ See Attached

1)
NOTICE: THIS SCHEDULE AND ATTACHMENTS REQUIRE ORIGINAL SIGNATURES ON EACH PAGE.

(Date) 12/19/16

(Name/Title-Please Print)

(If not the undersigned, signature of person who filled out this Schedule C)

Robert Hittifes
(Company Name-Please Print)

(Date)

12/19/16

(Signature of President/Owner/CEO or Authorized Agent of MBEA/VBE)

Shon Harris
(Name/Title-Please Print)

- 2)
- 3)
- 4)

Chicago Infrastructure Trust Chicago Smart Lighting Project

Schedule C: MBE/WBE Letter of Intent to Perform as a 2nd Tier Subcontractor to the Prime Contractor

Partial Pay Items

Total
Quantity/Unit Price

Quantity/Unit Price

For any of the above items that are partial pay items, specifically describe the work and subcontract dollar amount(s):

Pay Item No./Description

6)
7)

Subtotal: \$ _ Total @ 100%:

Total @ 60% (if the undersigned is performing work as a regular dealer): \$ _

SUB-SUBCONTRACTING LEVELS

A zero (0) must be shown in each blank if the MBE or WBE will not be subcontracting any of the work listed or attached to this schedule.

0 % of the dollar value of the MBE or WBE subcontract that will be subcontracted to non MBE/WBE contractors. 0 % of the dollar value of the MBE or WBE subcontract that will be subcontracted to MBE or WBE contractors.

NOTICE: If any of the MBE or WBE scope of work will be subcontracted, list the name of the vendor and attach a brief explanation, description and pay item number of the work that will be subcontracted. MBE/WBE credit will not be given for work subcontracted to Non-MBE/WBE contractors, except for as allowed in the Special Conditions Regarding Minority Business Enterprise Commitment and Women Business Enterprise Commitment in Construction Contracts.

The undersigned will enter into a formal written agreement for the above work with you as a Prime Contractor, conditioned upon your execution of a contract with the City of Chicago, within three (3) business days of your receipt of a signed contract from the City of Chicago.

The undersigned has entered into a formal written mentor protege agreement as a subcontractor/protege with you as a Prime Contractor/mentor: () Yes (x) No

NOTICE: THIS SCHEDULE AND ATTACHMENTS REQUIRE ORIGINAL SIGNATURES ON EACH PAGE.

f^As^>

12/19/16

(If not the undersigned, signature of person who filled out this Schedule C) (Date)

Robert Harris

Livewire Electrical Inc

(Name/Title-Please Print)

rharris@livewire-systems.com

(Email & Phone Number)

rj / rx

^

^-(Signature of President/Owner/CEO or Authorized Agent of MBE/WBE)

Shon Harris

(Name/Title-Please Print)

sharrii@livewire-systems.com

(Email & Phone Number)

8)
9)
10)
11)

Chicago Infrastructure Trust
Chicago Smart Lighting Project RFI - Attachment 2

TOTALS	\$
LI	494,010.0 494.0
	0 10.00
UNIT	54.89 MBE
PRIC	PART

E ICIP
ATION
(LIVE
WIRE
ELEC
TRIC
AL
SYST
EMS)
:

BID 9,000.00

QTY
U EACH

M
DES Arterial
CRIP(Feeder)
TIONLegacy
(66 Foot
ROW,
One-
Sided
Light Pole
Configurat
ion) -
INSTALL
ONLY

OFFICE OF CONTRACT COMPLIANCE JACQUELINE GOMEZ

DIRECTOR

118 N. Clark, County Building, Room 1020 • Chicago, Illinois 60602 • (312) 603-5502

May 27, 2016

TONI PRECKWINKLE

PRESIDENT Cook County Board of Commissioners

RICHARD R. BOYKIN 1st District

ROBERT STEELE 2nd District

JERRY BUTLER 3rd District

STANLEY MOORE 4th District

DEBORAH SIMS 5th District

JOAN PATRICIA MURPHY 6th District

JESUS G. GARCIA 7th District

LUIS ARROYO, JR. 8th District

PETER N. SILVASTRI 9th District

BRIDGET GAINER 10th District

JOHN P. DAILEY 11th District

JOHN A. FRITCHEY 12th District

LARRY SUFFREDIN 13th District

GREGG GOSUN 14th District

TIMOTHY O. SCHNEIDER 15th District

JEFFREY R TOBOLSKI 16th District

SEAN M MORRISON 17th District

Mr. La'Shon Harris, President Livewire Electrical Systems,
Inc. 12900 South Throop Street Calumet Park, IL 60827

Re: Annual Certification Expires: May 27, 2017

Dear Mr. Harris:

Congratulations on your continued eligibility for Certification as a Minority-owned Business Enterprise (MBE) by Cook County Government. This certification is valid until May 27, 2021; however, you must re-validate your firms' certification annually.

As a condition of continued Certification during this five (5) year term, you must file a "No Change Affidavit" within sixty (60) business days prior to the date of Annual Certification Expiration.

Failure to file this Affidavit shall result in the termination of your Certification. You must notify Cook County Government's Office of Contract Compliance of any change in ownership or control or any other matters or facts affecting your firm's eligibility for Certification within fifteen (15) business days of such change.

Cook County Government may commence action to remove your firm as an MBE vendor if you fail to notify us of any changes of facts affecting your firm's Certification, or if your firm otherwise fails to cooperate with the County in any inquiry or investigation. Removal of status may also be commenced if your firm is found to be involved in bidding or contractual irregularities.

Your firm's name will be listed in Cook County's Directory of certified firms in the following area(s) of specialty:

Construction: Electrical; Telecommunications and Mason Services

Your firm's participation on Cook County contracts will be credited toward MBE goals in your area(s) of specialty. While your participation on Cook County contracts is not limited to your specialty, credit toward MBE goals will be given only for work performed in the specialty category.

Thank you for your continued interest in Cook County Government's Minority, Women, Veteran, and Service-Disabled Veteran Business Enterprise Programs.

Sincerely,

U.

Jacqueline Gomez
Contract Compliance Director

JG/lar

\$ Fiscal Responsibility f Innovative Leadership \$) Transparency & Accountability £v Impioved Set vices

FOR CONSTRUCTION
PROJECTS ONLY

SCHEDULE C: MBE/WBE Letter of Intent to Perform as a 2nd Tier Subcontractor to the
Prime Contractor

NOTICE: THIS SCHEDULE MUST BE AUTHORIZED AND SIGNED BY THE MBE/WBE SUBCONTRACTOR FIRM. FAILURE TO COMPLY MAY RESULT IN THE BID BEING REJECTED AS NON-RESPONSIVE.

Project Name: Chicago smart Lighting Project

Specification No.: NA

From: Midwestern Electric Inc.

(Name of MBE/WBE Firm)
To: John Burns Construction Co.
(Name of 1st Tier Contractor)

To: Ameresco, Inc.

(Name of Prime Contractor)

and the City of Chicago.

The MBE or WBE status of the undersigned is confirmed by the attached City of Chicago or Cook County Certification Letter. 100% MBE or WBE participation is credited for the use of a MBE or WBE "manufacturer." 60% participation is credited for the use of a MBE or WBE "regular dealer."

The undersigned is prepared to perform the following services in connection with the above named project/contract. If more space is required to fully describe the MBE or WBE proposed scope of work and/or payment schedule, attach additional sheets as necessary. The description must establish that the undersigned is performing a commercially useful function:

MBE Electrical Subcontractor

The above described performance is offered for the following price and described terms of payment:

Pav Item No./Description	Quantity/Unit Price	Total
See Attached	See Attached	See Attached

Subtotal: \$ See Attached Total @ 100%: \$ See Attached

Total @ 60% (if the undersigned is performing work as a regular dealer): \$

NOTICE: THIS SCHEDULE AND ATTACHMENTS REQUIRE ORIGINAL SIGNATURES ON EACH PAGE.



_____ 12/16/10
(Date)

(If not the undersigned, signature of person who filled out this Schedule C) (Name/Title-Please Print)

(Signed President/Owner/CEO or Authorized Agent of MBE/WBE) (Name/Title-Please Print) *

- 1)
- 2)

Chicago Infrastructure Trust
Chicago Smart Lighting Project RFP - MUCUIMI 2

Schedule C: MBE/WBE Letter of Intent to Perform as a 2nd Tier Subcontractor to the Prime Contractor

Partial Pav Items

Pav Item No./Description	Quantity/Unit Price	Total
--------------------------	---------------------	-------

Subtotal:

Total @ 100%: \$

Total @ 60% (if the undersigned is performing work as a regular dealer): \$

SUB-SUBCONTRACTING LEVELS

A zero (0) must be shown in each blank if the MBE or WBE will not be subcontracting any of the work listed or attached to this schedule.

0 % of the dollar value of the MBE or WBE subcontract that will be subcontracted to non MBE/WBE contractors. 0 % of the dollar value of the MBE or WBE subcontract that will be subcontracted to MBE or WBE contractors.

NOTICE: If any of the MBE or WBE scope of work will be subcontracted, list the name of the vendor and attach a brief explanation, description and pay item number of the work that will be subcontracted. MBE/WBE credit will not be given for work subcontracted to Non-MBE/WBE contractors, except for as allowed in the Special Conditions Regarding Minority Business Enterprise Commitment and Women Business Enterprise Commitment in Construction Contracts.

The undersigned will enter into a formal written agreement for the above work with you as a Prime Contractor, conditioned upon your execution of a contract with the City of Chicago, within three (3) business days of your receipt of a signed contract from the City of Chicago.

The undersigned has entered into a formal written mentor protege agreement as a subcontractor/protege with you as a Prime Contractor/mentor: () Yes (^) No

NOTICE: THIS SCHEDULE AND ATTACHMENTS REQUIRE ORIGINAL SIGNATURES ON EACH PAGE.

(If not the undersigned, signature of person who filled out this Schedule C)

(Company Name-Please Print)

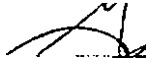

(Email & Phone Number)

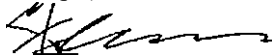

Signature of President/Owner/CEO or Authorized Agent of MBE/WBE)
t4-F

(Name/Title-Please Print)

(Email & Phone Number)

- 1)
- 2)
- 3)

Chicago Infrastructure Trust
Chicago Smart Lighting Project RFP - AiUcullinn * 1

TOTALS \$
L1 100,0100.0
00.0000.00
UNIT\$ MBE
PRIC200.0PART

U ICIP
TION
(MID
WEST
TERN
ELEC
TRIC)
:
BID 500.0
QTY 0
U EAC
H
M
DES Contr
CRIPoller
TIONModif
icatio
ns
(Parti
al
Pay
Item)
a* |
N/A

Department of Procurement Services

CITY OF CHICAGO

MAR 10 20W

Gerardo A. Garcia
Midwestern Electric Company, Inc. 15550
South Kedzie Markham, IL 60428-3904

Dear Mr. Garcia:

We are pleased to inform you that Midwestern Electric Company, Inc. has been re-certified as a Minority Business Enterprise ("MBE") by the City of Chicago ("City"). This MBE certification is valid until 06/01/2017; however your firm's certification must be re-validated annually. In the past the City has provided you with an annual letter confirming your certification; such letters will no longer be issued. As a consequence, we require you to be even more diligent in filing your annual No-Change Affidavit 60 days before your annual anniversary date.

It is now your responsibility to check the City's certification directory and verify your certification status. As a condition of continued certification during the five-year period stated above, you must file an annual No-Change Affidavit. Your firm's annual No-Change Affidavit is due by 06/01/2015, and 06/01/2016. Please remember, you have an affirmative duty to file your No-Change Affidavit 60 days prior to the date of expiration. Failure to file your annual No-Change Affidavit may result in the suspension or rescission of your certification.

Your firm's five year certification will expire on 06/01/2017. You have an affirmative duty to file for recertification 60 days prior to the date of the five year anniversary date. Therefore, you must file for recertification by 04/01/2017.

It is important to note that you also have an ongoing affirmative duty to notify the City, of any changes in ownership or control of your firm, or any other fact affecting your firm's eligibility for certification within 10 days of such change. These changes may include but are not limited to a change of address, change of business structure, change in ownership or ownership structure, change of business operations, gross receipts and or personal net worth that exceed the program threshold. Failure to provide the City with timely notice of such changes may result in the suspension or rescission of your certification. In addition, you may be liable for civil penalties under Chapter 1-22, "False Claims", of the Municipal Code of Chicago.

Please note - you shall be deemed to have had your certification lapse and will be ineligible to participate as a MBE if you fail to:

- File your annual No-Change Affidavit within the required time period;
- Provide financial or other records requested pursuant to an audit within the required time period;

121 NORTH LASALLE STREET, ROOM 806, CHICAGO ILLINOIS 60602

Midwestern Electric Company, Inc.

- Notify the City of any changes affecting your firm's certification within 10 days of such change; or
- File your recertification within the required time period.

Please be reminded of your contractual obligation to cooperate with the City with respect to any reviews, audits or investigation of its contracts and affirmative action programs. We strongly encourage you to assist us in maintaining the integrity of our programs by reporting instances or suspicions of fraud or abuse to the City's Inspector General at chicagoinspectorgeneral.org <<http://chicagoinspectorgeneral.org>>, or 866-IG-TIPLINE (866-448-4754).

Be advised that if you or your firm is found to be involved in certification, bidding and/or contractual fraud or abuse, the City will pursue decertification and debarment. In addition to any other penalty imposed by law, any person who knowingly obtains, or knowingly assists another in obtaining a contract with the City by falsely representing the individual or entity, or the individual or entity assisted is guilty of a misdemeanor, punishable by incarceration in the county Jail for a period not to exceed six months, or a fine of not less than \$5,000 and not more than \$10,000 or both.

Your firm's name will be listed in the City's Directory of Minority and Women-Owned Business Enterprises in the specialty area(s) of:

NAICS Code(s):
238210 - Electrical Contractors
1)238210 - Electrical Wiring Contractors

Your firm's participation on City contracts will be credited only toward Minority Business Enterprise goals in your area(s) specialty. While your participation on City contracts is not limited to your area of specialty, credit toward goals will be given only for work that is self-performed and providing a commercially useful function that is done in the approved specialty category.

Thank you for your interest in the City's Minority and Women-Owned Business Enterprise (MBE/WBE) Program.

Sincerely,

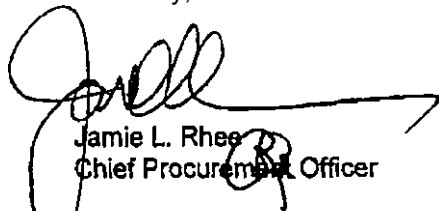

Jamie L. Rhee
 Chief Procurement Officer
 JLR/sl



I FOR I CONSTRUCTION

SCHEDULE C: MBE/WBE Letter of Intent to Perform as a PROJECTS ONLY
 2"d Tier Subcontractor to the Prime Contractor

NOTICE: THIS SCHEDULE MUST BE AUTHORIZED AND SIGNED BY THE MBE/WBE SUBCONTRACTOR FIRM. FAILURE TO COMPLY MAY RESULT IN THE BID BEING REJECTED AS NON-RESPONSIVE.

Project Name: Chicago Smart Lighting Project : Specification Noj NA

From: The BarTech Group, Inc.
 (Name of MBE/WBE Firm)

To: John Burns Construction Co.

To: JOHN DUMS CONSTRUCTIONS CO
(Name of 1st Tier Contractor)

To: Ameresco, Inc.
(Name of Prime Contractor)

and the City of Chicago.

The MBE or WBE status of the undersigned is confirmed by the attached City of Chicago or Cook County Certification Letter. 100% MBE or WBE participation is credited for the use of a MBE or WBE "manufacturer." 60% participation is credited for the use of a MBE or WBE "regular dealer."

The undersigned is prepared to perform the following services in connection with the above named project/contract. If more space is required to fully describe the MBE or WBE proposed scope of work and/or payment schedule, attach additional sheets as necessary. The description must establish that the undersigned is performing a commercially useful function:

MBE Electrical Subcontractor

The above described performance is offered for the following price and described terms of payment:

Pay Item No./Description	Quantity/Unit Price	Total
	2)	
		Subtotal: \$
		Total @ 100%: \$

Total @ 60% (if the undersigned is performing work as a regular dealer): \$___

NOTICE: THIS SCHEDULE AND ATTACHMENTS REQUIRE ORIGINAL SIGNATURES ON EACH PAGE.

(If not the undersigned, signature of person who filled out this Schedule C) (Date)

(Name/Title-Please Print)

(Company Name-Please Print)

Cu)^_c fi^--,

y^n

(Signature of President/Owner/CEO or Authorized Agent of MBE/WBE)

(Date) (Name/Title-Please Print)

Chicago Infrastructure Trust Chicago Smart Lighting Project (IF I'

Schedule C: MBE/WBE Letter of intent to Perform as a 2nd Tier Subcontractor to the Prime Contractor Partial Pay Items

For any of the above items that are partial pay items, specifically describe the work and subcontract dollar amount(s):

Pay Item No./Description	Quantity/Unit Price	Total
--------------------------	---------------------	-------

Subtotal: \$

Subtotal: \$

Total@ 100%:\$

Total@ 60% (if the undersigned is performing work as a regular dealer): S_ _ _ _

SUB-SUBCONTRACTING LEVELS

A zero (0) must be shown in each blank if the MBE or WBE will not be subcontracting any of the work listed or attached to this schedule.

0_ % of the dollar value of the MBE or WBE subcontract that will be subcontracted to non MBE/WBE contractors.

% of the dollar value of the MBE or WBE subcontract that will be subcontracted to MBE or WBE contractors

NOTICE: If any of the MBE or WBE scope of work will be subcontracted, list the name of the vendor and attach a brief explanation, description and pay item number of the work that will be subcontracted. MBE/WBE credit will not be given for work subcontracted to Non-MBE/WBE contractors, except for as allowed in the Special Conditions Regarding Minority Business Enterprise Commitment and Women Business Enterprise Commitment in Construction Contracts.

The undersigned will enter into a formal written agreement for the above work with you as a Prime Contractor, conditioned upon your execution of a contract with the City of Chicago, within three (3) business days of your receipt of a signed contract from the City of Chicago.

The undersigned has entered into a formal written mentor protege agreement as a subcontractor/protege with you as a Prime Contractor/mentor: () Yes (x) No

NOTICE: THIS SCHEDULE AND ATTACHMENTS REQUIRE ORIGINAL SIGNATURES ON EACH PAGE.

(If not the undersigned, signature of person who filled out this Schedule C) (Date)

(Name/Title-Please Print)

(Company Name-Please Print)

(Email & Phone Number)

GXc^_^

M, 20(7

(Signature of President/Owner/CEO or Authorized Agent of MBEAA/BE)

O (Date)

"Dig

(Name/Title-Please Print)

(Email & Phone Number)

<S 1

- 1)
- 2)
- 3)
- 4)

Chicago Infrastructure Trim
Chicago Smart Lighting Project R1-1 - Ailectnium

TOT \$ \$
 AL | 10,000.0 10.0
 0 00.0
 0 |
 UNI \$ 50.00 MBE
 T PAR

PRI TICI
CE PATI
ON
(PMI
SYS
TEM
S,
INC.
dba
BAR
TEC
H
GRO
UP):

BID 200.00

QTY

5 EACH

DES Arterial
CRI (Feeder)

PTI Legacy

ON (66 Foot
ROW,
One-
Sided
Light
Pole
Configur
ation) -
INSTALL
ONLY
*cr



TONI PRECKWINKLE

PRESIDENT Cook County Board of Commissioners

RICHARD R. BOYKIN 1st District

ROBERT STEELE 2nd District

JERRY BUTLER 3rd District

STANLEY MOORE 4th District

DEBORAH SIMS 5th District

JOAN PATRICIA MURPHY 6th District

JESUS G. GARCIA 7th District

LUIS ARROYO, JR 8th District

PETER N. SILVESTRI 9th District

BRIDGET GAINER 10th District

JOHN P. DALEY 11th District

JOHN A. FRITCHEY 12th District

LARRY SUFFREDIN 13th District

GREGG (BOSUN) 14th District

TIMOTHY O. SCHNEIDER 15th District

JEFFREY R TOBOLSKI 16th District

SEAN M. MORRISON 17th District

OFFICE OF CONTRACT COMPLIANCE JACQUELINE GOMEZ

DIRECTOR

118 N. Clark, County Building, Room 1020 • Chicago, Illinois 60602 • (312) 603-5502

June 21, 2016

Mr. Dwayne K. Barlow, President
PMI Systems, Inc. dba The BarTech Group
44 West 60th Street
Chicago, IL 60612

Annual Certification Expires: June 21, 2017

Dear Mr. Barlow:

We are pleased to inform you that PMI Systems, Inc. dba The BarTech Group has been certified as a Minority-owned Business Enterprise (MBE) by Cook County Government. This certification is valid until June 21, 2021; however, you must re-validate your firm's certification annually.

As a condition of continued Certification during this five (5) year term, you must file a "No Change Affidavit" within sixty (60) business days prior to the date of Annual Certification Expiration. Failure to file this Affidavit shall result in the termination of your Certification. You must notify Cook County Government's Office of Contract Compliance of any change in ownership or control or any other matters or facts affecting your firm's eligibility for Certification within fifteen (15) business days of such change.

Cook County Government may commence action to remove your firm as an MBE vendor if you fail to notify us of any changes of facts affecting your firm's Certification, or if your firm otherwise fails to cooperate with the County in any inquiry or investigation. Removal of status may also be commenced if your firm is found to be involved in bidding or contractual irregularities.

Your firm's name will be listed in Cook County's Directory of certified firms in the following area(s) of specialty:

**Construction - Electrical Contractor; Project Management, Quality Control Services, Security
Fencing & Construction Management**

Your firm's participation on Cook County contracts will be credited toward MBE goals in your area(s) of specialty. While your participation on Cook County contracts is not limited to your specialty, credit toward MBE goals will be given only for work performed in the specialty category.

Thank you for your continued interest in Cook County Government's Minority, Women, Veteran, and Service-Disabled Veteran Business Enterprise Programs.

Sincerely,

2)
3)

Jacqueline Gomez
Contract Compliance Director

JG/ew

\$ Fiscal Responsibility ^ Innovative Leadership @ Transparency & Accountability \J Improved Services

4)

SCHEDULE C: MBE/WBE Letter of Intent to Perform as a 2nd Tier Subcontractor to the Prime Contractor
FOR CONSTRUCTION PROJECTS ONLY

NOTICE: THIS SCHEDULE MUST BE AUTHORIZED AND SIGNED BY THE MBE/WBE SUBCONTRACTOR FIRM. FAILURE TO COMPLY MAY RESULT IN THE BID BEING REJECTED AS NON-RESPONSIVE.

Chicago Smart Lighting Project

To: To:

From: City Lights, Ltd.

.....
(Name of MBEAA/BE Firm)
John Burns Construction Co. ,
(Name of 1st Tier Contractor)

Amarasco, Inc.
(Name of Prime Contractor)

The MBE or WBE status of the undersigned is confirmed by the attached City of Chicago or Gbok County Certification Letter. 100% MBE or WBE participation is credited for the use of a MBE or WBE "manufacturer." 60% participation is credited for the use of a MBE or WBE "regular dealer."

The undersigned is prepared to perform the following services in connection with the above named project/contract. If more space is required to fully describe the MBE or WBE proposed scope of work and/or payment schedule, attach additional sheets as necessary. The description must establish that the undersigned is performing a commercially useful function: Electrical Subcontractor

The above described performance is offered for the following price and described terms of payment:

Pav Item No./Description	Quantity/Unit Price	Total
See Attached	See Attached	See Attached

Subtotal: \$ See Attached

Total @ 100%: \$ Sea AttarhftH

Total @ 60% (if the undersigned is performing work as a regular dealer): \$

NOTICE: THIS SCHEDULE AND ATTACHMENTS REQUIRE ORIGINAL SIGNATURES ON EACH PAGE.

(If not the undersigned, signature of person who filled out this Schedule C) (Date)

X (Name of MBE/BE Firm) ^ ^ (Company Name-Please Print)
 \ ^ / ^ ^ March 28, 2017
 (Signature of President/Owner/CEO or Authorized Agent of MBEAA/BE) (Date)
 John Candelaria/Sr. Vice President
 (Name/Title-Please Print)

- 1)
- 2)

Chicago Infrastructure Trust
 Chicago Smart Lighting Project RFP., Aikljiulim ?3

Schedule C: MBE/WBE Letter of Intent to Perform as a 2nd Tier Subcontractor to the Prime Contractor

Partial Pay Items

For any of the above items that are partial pay items, specifically describe the work and subcontract dollar amount(s):

Pav Item No./Description	Quantity/Unit Price	Total
NA	NA	NA
		<u>Subtotal:</u> ■ NA
		Total @ 100%: \$ NA
		<u>Total @ 60% (If the undersigned is performing work as a regular dealer):</u> \$ NA

SUB-SUBCONTRACTING LEVELS

A zero (0) must be shown in each blank if the MBE or WBE will not be subcontracting any of the work listed or attached to this schedule.

0 % of the dollar value of the MBE or WBE subcontract that will be subcontracted to non MBE/WBE contractors. 0 % of the dollar value of the MBE or WBE subcontract that will be subcontracted to MBE or WBE contractors. •'

NOTICE: If any of the MBE or WBE scope of work will be subcontracted, list the name of the vendor and attach a brief explanation, description and pay item number of the work that will be subcontracted. MBE/WBE credit will not be given for work subcontracted to Non-MBE/WBE contractors, except for as allowed in the Special Conditions Regarding Minority Business Enterprise Commitment and Women Business Enterprise Commitment in Construction Contracts.

The undersigned will enter into a formal written agreement for the above work with you as a Prime Contractor, conditioned upon your execution of a contract with the City of Chicago, within three (3) business days of your receipt of assigned contract from the City of Chicago.

The undersigned has entered into a formal written mentor protege agreement as a subcontractor/protege with you as a Prime Contractor/mentor: ()Yes (x) No

NOTICE: THIS SCHEDULE AND ATTACHMENTS REQUIRE ORIGINAL SIGNATURES ON EACH PAGE.

(If not the undersigned, signature of person who filled out this Schedule C) (Date)

(Name/Title-Please Print)

(Company Name-Please Print)

1)

March 28, 2017 (Date)

(Name/Title-Please Print)

info@citylightsltd.com <<mailto:info@citylightsltd.com>> 773-626-9162

(Email & Phone Number)

- 1)
- 2)
- ~

3)

Chicago Infrastructure Trust
Chicago Smart Lighting Project RFP - Acknowledgment *2

TOTALS \$
 LI 10,500.00 10,500.00
 UNIT \$ 60.00 CITY
 PRICE LIGHTS,
 (LTD.)
 :
 BID 175.00 MBE
 QUANTITY PART
 ICIPATI
 ON
 1
 U EACH
 M
 DESCRIPTION Arterial
 CRIP (Feeder)
 TION Legacy
 (66 Foot
 ROW, One
 -Sided
 Light Pole
 Configuration)
 INSTALL
 ONLY

Department of Procurement Services city of chicago

1)
MAR 04 2014

Jacqueline Hoffman City Lights, Ltd.
9993 Virginia Avenue Chicago Ridge, IL
60415

Dear Ms. Hoffman:

We are pleased to inform you that City Lights, Ltd. has been re-certified as a Minority Business Enterprise ("MBE") and Woman Business Enterprise ("WBE") by the City of Chicago ("City"). This MBE/WBE certification is valid until 05/01/2017; however your firm's certification must be re-validated annually. In the past the City has provided you with an annual letter confirming your certification; such letters will no longer be issued. As a consequence, we require you to be even more diligent in filing your annual No-Change Affidavit 60 days before your annual anniversary date.

It is now your responsibility to check the City's certification directory and verify your certification status. As a condition of continued certification during the five-year period stated above, you must file an annual No-Change Affidavit. Your firm's annual No-Change Affidavit is due by 05/01/2015 and 05/01/2016. Please remember, you have an affirmative duty to file your No-Change Affidavit 60 days prior to the date of expiration. Failure to file your annual No-Change Affidavit may result in the suspension or rescission of your certification:

Your firm's five year certification will expire on 07/01/2017. You have an affirmative duty to file for recertification 60 days prior to the date of the five year anniversary date. Therefore, you must file for recertification by 05/01/2017.

It is important to note that you also have an ongoing affirmative duty to notify the City of any changes in ownership or control of your firm, or any other fact affecting your firm's eligibility, for certification within 10 days

of such change. These changes may include but are not limited to a change of address, change of business structure, change in ownership or ownership structure, change of business operations, gross receipts and or personal net worth that exceed the program threshold. Failure to provide the City with timely notice of such changes may result in the suspension or rescission of your certification. In addition, you may be liable for civil penalties under Chapter 1-22, "False Claims", of the Municipal Code of Chicago.

Please note - you shall be deemed to have had your certification lapse and will be ineligible to participate as a MBE/WBE if you fail to:

2)

121 NORTH LASALLE STREET, ROOM 806, CHICAGO ILLINOIS 60602

City Lights, Ltd.

- File your annual No-Change Affidavit within the required time period;
- Provide financial or other records requested pursuant to an audit within the required time period;
- Notify the City of any changes affecting your firm's certification within 10 days of such change; or
- File your recertification within the required time period.

Please be reminded of your contractual obligation to cooperate with the City with respect to any reviews, audits or investigation of its contracts and affirmative action programs. We strongly encourage you to assist us in maintaining the integrity of our programs by reporting instances or suspicions of fraud or abuse to the City's Inspector General at chicagoinspectorgeneral.org <<http://chicagoinspectorgeneral.org>>, or 866-IG-TIPLINE (866-448-4754).

Be advised that if you or your firm is found to be involved in certification, bidding and/or contractual fraud or abuse, the City will pursue decertification and debarment. In addition to any other penalty imposed by law, any person who knowingly obtains, or knowingly assists another in obtaining, a contract with the City by falsely representing the individual or entity, or the individual or entity assisted, is a minority-owned business or a woman-owned business, is guilty of a misdemeanor, punishable by incarceration in the county jail for a period not to exceed six months or a fine of not less than \$5,000 and not more than \$10,000 or both.

Your firm's name will be listed in the City's Directory of Minority and Women-Owned Business Enterprises in the specialty area(s) of:

NAICS Code(s):

237310 - Highway, Street, and Bridge Construction 238210 - Electrical Contractors

Your firm's participation on City contracts will be credited only toward Minority Business Enterprise and Woman Business Enterprise goals in your area(s) specialty. While your participation on City contracts is not limited to your area of specialty, credit toward goals will be given only for work that is self-performed and providing a commercially useful function that is done in the approved specialty category.

Sincerely,

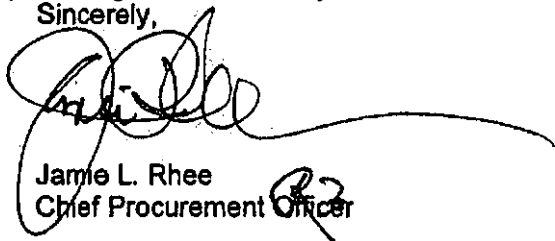

Handwritten signature of Jamie L. Rhee, Chief Procurement Officer.

Jamie L. Rhee
Chief Procurement Officer

JLR/sl

Thank you for your interest in the City's Minority and Women-Owned Business Enterprise (MBE/WBE) Program.

SCHEDULE D: Compliance Plan Regarding

**MBE & WBE Utilization Affidavit of Prime Contractor
FOR CONSTRUCTION PROJECTS ONLY**

MUST BE SUBMITTED WITH THE BID. FAILURE TO SUBMIT THE SCHEDULE D WILL CAUSE THE BID TO BE REJECTED. DUPLICATE AS NEEDED.

Project Name: Chicago Infrastructure Trust Chicago Smart Lighting Project

Specification No.: NA

In connection with the above captioned contract, I HEREBY DECLARE AND AFFIRM that I am the

Chief Financial Office ¹ and a duly authorized representative of
 (Title of Affiant)
 Ameresco, Inc.
 (Name of Prime Contractor)

and that I have personally reviewed the material and facts set forth in the attached Schedule Cs regarding Minority Business Enterprise and Women Business Enterprise (MBEAA/BE) to perform as subcontractor, Joint Venture Agreement, and Schedule B (if applicable). All MBEs and WBEs must be certified with the City of Chicago or Cook County in the area(s) of specialty listed.

Name of MBE	Type of Work to be Performed in accordance with Schedule Cs	Total MBE Participation in dollars	MBE, Participation in > percentage	Mentor Protege Program • Credit Claimed:	Total MBE, Participation in' - . - percentage
The BarTech Group, Inc.	Electrical Subcontractor	\$10,000.00	.01%	0%	.01%
City Lights, LTD	Electrical Subcontractor	\$10,500.00	.01%	0%	.01%
DSR Group, Inc.	Construction Management	\$50,000.00	.03%	0%	.03%
Livewire Electrical Systems Inc.	Electrical Subcontractor	\$494,010.00	.33%	0%	.33%
Lyons View Manufacturer & Supply, Inc	Electrical Manufacturer & Supply	\$32,793,090.00	21.86%	• 0%	21.86%
Midwestern Electric, Inc.	Electrical Subcontractor	\$100,000.00	.07%	0%	.07%

^Infrastructure + Tech + Luminaires**	**Combination of vendors & suppliers listed above**	\$9,061,925.00	6.04%	0%	6.04%
		\$	%	%	%
		\$	%	%	%
		\$	%	%	%
		\$	%	%	%
		\$	%	%	%

Chicago Infrastructure Trust
Chicago Smart Lighting Project KIP - Addendum #2

Name of	Type of Work, to be performed in	Total WBE Participation in dollars,	WBE Participation in percentage	Mentor Protege Program Credit - Claimed*	Total WBE Participation in percentage
WBE	accordance with Schedule Cs		n in percentage		in percentage
Anchor Staffing, Inc.	Field Technicians	\$303,264.00	.20%	0%	.20%
Evergreen Supply Co.	Electrical Supply	\$8,477,532.00	5.65%	0%	5.65%
Horizon Contractors, Inc.	Electrical Subcontractor	\$104,952.00	.07%	%	.07%
^Infrastructure + Tech + Luminaires**	**Combination of vendors & suppliers listed above**	\$2,446,425.00	1.63%	%	1.63%
		\$	%	%	%
		\$	%	%	%
		\$	%	%	%
		\$	%	%	%
		\$	%	%	%

Check here if the following is applicable: The Prime Contractor intends to enter into mentor protege agreements with certain MBEs/WBEs listed above as indicated by entries in the "Mentor Protege Program Credit Claimed" column. Copies of each proposed mentoring program, executed by authorized representatives of the Prime Contractor and respective subcontractor, are attached to this Schedule D. The Prime Contractor may claim an additional 0.333 percent participation credit (up to a maximum of five (5) percent) for every one (1) percent of the value of the contract performed by the MBEA/BE protege firm.

Total MBE Participation \$ 42,519,525.00

Total MBE Participation % (including any Mentor Protege Program credit) 28.35%

Total WBE Participation \$ 11,332,173.00

Total WBE Participation % (including any Mentor Protege Program credit) 7.55%

Total Bid \$ 150,000,000.00

To the best of my knowledge, information and belief the facts and representations contained in the aforementioned attached Schedules are true, and no material facts have been omitted.

The Prime Contractor designates the following person as its MBEA/BE Liaison Officer:

The Prime Contractor designates the following person as its IDEA/BE Liaison Officer.

Fernando Orihuela, Director of Construction
(Name- Please Print or Type) (Phone)

630-203-2615

Chicago Infrastructure Trust
Chicago Smart Lighting Project KIP - Addendum 111

I DO SOLEMNLY DECLARE AND AFFIRM UNDER PENALTIES OF PERJURY THAT THE CONTENTS OF THE FOREGOING DOCUMENT ARE TRUE AND CORRECT, AND THAT I AM AUTHORIZED ON BEHALF OF THE PRIME CONTRACTOR TO MAKE THIS AFFIDAVIT.

AMERESCO, Inc.

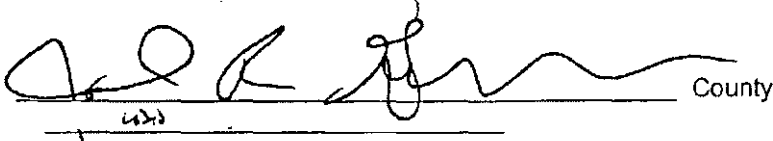
 County

of: ^IS/L^f^g-rfC
of: \ m- ig^gx
(Signaoire)
(Name of Prime Contractor - Print or Type)

John R. Granara, Chief Financial Officer

(Name of Affiant - Print or Type)

March 28, 2017
(Date)

On this 28 day of March, 2017, the above signed officer

(Name of Affiant)

personally appeared and, known by me to be the person described in the foregoing Affidavit, acknowledged that (s)he executed the same in the capacity stated therein and for the purposes therein contained.

IN WITNESS WHEREOF, I hereunto set my hand and seal.



(Notary)

Aa ft. U

Public Signature)

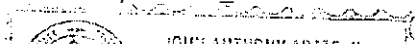
SEAL:

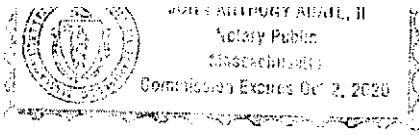
Commission Expires: <f



Chicayo Infrastrucuiie Trust
Chicago Smart Liyluui!; Project RFP - Addendum

EXHIBIT 6: PERFORMANCE AND PAYMENT BOND

A. PERFORMANCE BOND

The successful bidder or bidders shall, within seven (7) calendar days of receipt of notice from the City, furnish a Performance and Payment Bond ("Performance Bond") in an amount equal to the lesser of (a) \$50 Million or (b) the value of outstanding Work Orders for the LED Conversion and Infrastructure Stabilization Scopes of Work on the following Exhibit 6 form, a specimen of which is bound herein. In the event the City elects to extend this Contract, the Contractor will provide a Performance Bond in compliance with the terms and conditions herein.

Receipt of written notice from the City to furnish a Performance Bond constitutes tentative notice of pending award and proposal acceptance. Release of the Contract shall be withheld pending receipt and approval of a satisfactory Performance Bond.

The Performance Bond shall have a term of one (1) year, but every year it will be renewed for an additional one (1) year term until the term of the Contract ends. The renewals will occur without any affirmative act on the part of the surety, Contractor, or the City. However, the surety may elect not to renew the Performance Bond by providing written notice of non-renewal to the Contractor and the City of Chicago Department of Procurement Services no later than ninety (90) calendar days prior to the date which is one year after the date on which the Chief Procurement Officer approves the Performance Bond ("Anniversary Date") and no later than ninety (90) calendar days prior to each one-year period thereafter. The notice must clearly identify this Contract and include a copy of this page of the Contract. If notice of non-renewal is not received by the Department of Procurement Services ninety (90) calendar days prior to the Anniversary Date, the Performance Bond shall be renewed for another year. If the Performance Bond is not renewed, the Contractor must furnish a replacement bond no later than thirty (30) calendar days following receipt of the notice of non-renewal or sixty (60) calendar days prior to the anniversary of the bid opening date, whichever is earlier. Contractor's failure to provide a replacement Performance Bond shall constitute an event of default under the Contract, but not a loss recoverable under the bond.

Attention is called to the provisions of 30 ILCS 550/1, et seq., and to the provisions of Section 2-92-030 of the Municipal Code of Chicago.

B. FAILURE TO FURNISH BOND

In the event that the bidder fails to furnish the-performance bond in said period of seven (7) calendar days, then the bid deposit of the bidder will be retained by the City as liquidated damages and not as a penalty.

Performance and Payment Bond

RIDER ATTACHED

CONTRACTOR'S PERFORMANCE & PAYMENT BOND

Know All Men by these Presents, That we,

COMPANY NAME
STREET ADDRESS CITY, STATE
ZIP CODE

Principal, hereinafter referred to as Contractor, and _____, Surety of the
County of _____ and State of _____, are held and firmly bound unto the CITY OF
CHICAGO in the penal sum of:

- Dollar Amount in Words and 00/100 Dollars (\$ _____) -

lawful money of the United States, for the payment of which sum of money, well and truly to be made, we bind ourselves, our heirs, executors,
administrators, successors and assigns, jointly and severally, firmly by these presents.

Sealed with our seals and dated this _____ day of _____, 20_____.

Condition of the Above Obligation is such, that whereas the above bounden Contractor has entered into a certain contract with the City of Chicago,
bearing

Contract No. XXXXX and Specification No. XXXXXX all in conformity with said contract, for,

Furnishing the City of Chicago, Name of User Department, all labor, tools, material, and equipment required and necessary for the project known as:

CHICAGO SMART LIGHTING PROJECT

* The attached rider is incorporated herein by reference.

Now, if the said Contractor shall in all respects well and truly keep and perform the said contract on its part, in accordance with the terms and
provisions of all of the Contract Documents comprising said contract, and in the time and manner therein prescribed, and further shall save,
indemnify, and keep harmless the City of Chicago against all loss, damages, claims, liabilities, judgments, costs and expenses which may in anywise
accrue against said City of Chicago, in consequence of the granting of said contract, or which may in anywise result therefrom, or which may result
from strict liability, or which may in anywise result from any injuries to, or death of, any person, or damage to any real or personal property, arising
directly or indirectly from or in connection with, work performed or to be performed under said contract by said Contractor, its Agents, Employees
or Workmen, assignees, subcontractors, or anyone else, in any respect whatever, or which may result on account of any infringement of any patent
by reason of the materials, machinery, devices or apparatus used in the performance of said contract, and moreover, shall pay to said City any sum or
sums of money determined by the Purchasing Agent, and/or by a court of competent jurisdiction, to be due said City by reason of any failure or
neglect in the performance of the requirements of said contract, wherefore the said Purchasing Agent shall have elected to suspend or cancel the
same, and shall pay all claims and demands whatsoever, which may accrue to each and every materialman and subcontractor, and to each and every

same, and shall pay all claims and demands whatsoever, which may accrue to each and every machineman and subcontractor, and to each and every person who shall be employed by the said Contractor or by its assignees and subcontractors, in or about the performance of said contract, and with wages paid at prevailing wage rates if so required by said contract, and shall insure its liability to pay the compensation, and shall pay all claims and demands for compensation which may accrue to each and every person who shall be employed by them or any of them in or about the performance of said contract, or which shall accrue to the beneficiaries or dependents of any such person, under the provisions of the Workers' Compensation Act, 820 ILCS 305, as amended, and the Workers' Occupational Disease Act, 820 ILCS 310, as amended (hereinafter referred to as "Acts") then is this obligation to be null and void, otherwise to remain in full force and effect.

And it is hereby expressly understood and agreed, and made a condition hereof that any judgement rendered against said City in any suit based upon any loss, damages, claims, liabilities, judgements, costs or expenses which may in anywise accrue against said City as a consequence of the granting of said contract, or which may in anywise result therefrom, or which may in anywise result from

Performance and Payment Bond 279

*C-ty Fijrids-ti ?rofe:*A-r.ai Service* X".» .jVc -k*

i

any injuries to, or death of, any person, or damage to any real or personal property; arising directly or indirectly from, or in connection with, work performed, or to be performed under said contract by said Contractor or its agents, employees or workmen, assignees, subcontractors, or anyone else and also any decision of the Industrial Commission of the State of Illinois; and any order of court based upon such decision, or judgement thereon, rendered' against said City of Chicago in any suit or claim arising under the aforementioned Acts when notice of the pendency or arbitration proceedings or suit shall have been given said Contractor, shall be conclusive against each and all parties to this obligation, as to amount, liability and all other things pertaining thereto.

Every person furnishing material or performing labor in the performance of said contract, either as an individual, as a subcontractor, or otherwise, shall have the right to sue on this bond in the name of the City of Chicago for his use and benefit and in such suit said person as plaintiff, shall file a copy of this bond, certified by the party or parties in whose charge this bond shall be, which copy shall be, unless execution thereof be denied under oath; prima facie evidence of the execution and delivery of the original; provided, that nothing in this bond contained shall be taken to make the City of Chicago liable to any subcontractor, materialman, laborer or to any other person to any greater extent than it would have been liable prior to the enactment of the Public Construction Bond Act, 30 ILCS 5 5 0, as amended; provided further, that any person having a claim for labor and materials furnished in the performance of this contract shall have no right of action unless he shall have filed a verified notice of such claim with the Clerk of the City of Chicago within one hundred eighty (180) days after the date of the last item of work or the furnishing of the last item of materials, and shall have furnished a copy of such verified notice to the contractor within ten (10) days of the filing of the notice with the City of Chicago. Such claim shall lie verified and shall contain the name and address of the claimant, the business address of the claimant within the State of Illinois, if any, or if the claimant be a foreign corporation having no place of business with the State the principal place of business of said corporation, and in all cases of partnership the names and residences of each, of the partners, the name of the contractor for the City of Chicago, the name of the person, firm or corporation by whom the claimant was employed or to whom such claimant furnished materials, the amount of the claim and a brief description of the public improvement for the construction or installation of which the contract is to be performed. Provided, further that no defect in the notice herein provided for shall deprive the claimant of his right of action under the terms and provisions of this bond unless it shall affirmatively appear that such defect has prejudiced the rights of an interested party asserting the same; provided, further, that no action shall be brought until the expiration of one hundred twenty (120) days after the date of the last item of work or of the furnishing of the last item of material, except in cases where the final settlement between the City of Chicago and the Contractor shall have been made prior to the expiration of the 120-day period in which case action may be taken immediately following such final settlement, and provided, further that no action of any kind shall be brought later than six (6) months after the acceptance by the City of Chicago of the completion of work. Any suit upon this bond shall be brought only in a circuit court of the State of Illinois in the judicial district in which the contract shall have been performed.

The said Surety, for value received, hereby stipulates and agrees that no change, extension of time, alteration or addition to the terms of any of the Contract Documents comprising said contract, or to the work to be performed thereunder, shall in anywise affect the obligations on this bond, and it does by waive notice of any such change, extension of time, alteration or addition to the terms of said Contract Documents or to the work.

CONTRACTOR

(Seal)

Approved: , 20

By: President

(Seal)

Chief Procurement Officer

Attest: Secretary

(Seal)

(Seal)

(Seal)

Performance and Payment Bond
STATE OF ILLINOIS COUNTY OF COOK

I

aforesaid, DO HEREBY CERTIFY that_

, a Notary Public in and for the County and State

President and

Z. O

p

. Secretary of the_

. President and_
such.

who are personally known to me to be the same persons whose names are subscribed in the foregoing instrument as
. Secretary, appeared

before me this day in person and acknowledged that they signed, sealed and delivered the said instrument of writing as

their free and voluntary act, and as the free and voluntary act of the said
for the uses and purposes therein set forth, and caused the corporate seal of said Company to be thereto attached.

GIVEN under my hand and Notarial Seal this _____ day of _____ 20_

Notary Public

(STATE OF ILLINOIS, COUNTY' OF COOK,

, a Notary Public in and for the County and State

1

**O
a,
O
U**

PC
of the
who
aforesaid, DO HEREBY CERTIFY that_
. personally known

. whose name _____ subscribed in the foregoing instmment as such_
_free and voluntary act, and as the free

_____, appeared before me this day in person and acknowledged that
signed, sealed and delivered the said instrument of writing as_

and voluntary act of the said

and voluntary act of the said_
for the uses and purposes therein set forth, and caused the corporate seal of said Company to be thereto attached.

GIVEN under my hand and Notarial Seal this day of 20_

Notary Public

STATE OF ILLINOIS COUNTY OF COOK

. a Notary Public in and for die County and State

aforsaid. DO HEREBY CERTIFY that

who personally known to me to be the same persons whose name .
u > £5

6

.he_ signed, sealed and delivered the
instrument, appeared before me this day in person and acknowledged that_

said instrument of writing as free and voluntary act, for the uses and purposes therein set forth

GIVEN under my hand and Notarial Seal this day of
20

Notary Public

GRC-160211-26-1

RIDER TO CONTRACTOR'S PERFORMANCE AND PAYMENT BOND

This Rider supplements Contractor's Performance and Payment Bond ("Bond") on that certain
contract with the City of Chicago ("City") bearing Contract No. and Specification No.
("Contract"). Surety acknowledges that the Contract requires Contractor to obtain from each of its subcontractors
consent to a collateral assignment of their contracts with Contractor to the City. The Contract further grants the
City the right, upon Contractor's default for failure to comply with Chapter 4-36 of the Municipal Code of the
City, and at the City's sole option, to take over and complete the work to be performed by Contractor through the
City's assumption of some or all of Contractor's subcontracts. If the City, in its sole discretion, exercises this right,
then Surety waives any rights it may have to cure Contractor's default by performing the work itself or through
others and remains bound by its other obligations under the Bond.

Performance and Payment Bond

EXHIBIT 7: DATA PROTECTION REQUIREMENTS FOR CONTRACTORS, VENDORS AND THIRD-PARTIES

"Breach" means the acquisition, access, use, or disclosure of Protected Information that compromises the security or privacy of the Protected Information.

"Contractor" means an entity that receives or encounters Protected Information. Contractor includes, without limitation, entities that store Protected Information, or host applications that process Protected Information. The provisions of this Data Policy includes not only the entity that is a signatory to this Policy but all subcontractors, of whatever tier, of that entity; the signatory must inform and obtain the agreement of such subcontractors to the terms of this Data Policy.

"Protected Information" means all data provided by City to Contractor or encountered by Contractor in the performance of the services to the City, including, without limitation, all data sent to Contractor by City and/or stored by Contractor on its servers. Protected Information includes, but is not limited to, employment records, medical and health records, personal financial records (or other personally identifiable information), research data, and classified government information. To the extent there is any uncertainty as to whether any data constitutes Protected Information, the data in question shall be treated as Protected Information.

1. Information Security. Contractor agrees to the following:

1.1. General. Notwithstanding any other obligation of Contractor under this policy, Contractor agrees that it will not lose, alter, or delete, either intentionally or unintentionally, any Protected Information, and that it is responsible for the safe-keeping of all such information, except to the extent that the City directs the Contractor in writing to do so.

2. Access to Data. In addition to the records to be stored / maintained by Contractor, all records that are possessed by Contractor in its service to the City of Chicago to perform a governmental function are public records of the City of Chicago pursuant to the Illinois Freedom of Information Act (FOIA), unless the records are exempt under the Act. FOIA requires that the City produce records in a very short period of time. If the Contractor receives a request from the City to produce records, the Contractor shall do so within 72 hours of the notice.

3. Minimum Standard for Data at Rest and Data in Motion. Contractor must, at a minimum, comply, in its treatment of Protected Information, with National Institute of Standards and Technology (NIST) Special Publication 800-53 Moderate Level Control. Notwithstanding this requirement, Contractor acknowledges that it must fully comply with each additional obligation contained in this policy. If data is protected health information or electronic protected health information, as defined in the Health Insurance Portability and Accountability Act and Health Information Technology for Economic and Clinical Health Act (HIPAA/HITECH) and regulations implementing these Acts (see 45 CFR Parts 160 and 164), it must be secured in accordance with "Guidance Specifying the Technologies and Methodologies that Render Protected Health Information Unusable, Unreadable, or Indecipherable to Unauthorized Individuals," available on the United States Department of Health and Human Services (HHS) website <<http://www.hhs.gov/ocr/privacy/hipaa/admin>> or at Volume 74 of the Federal Register, beginning at page 42742. That guidance from the HHS states that valid encryption processes for protected health information data

at rest (e.g., protected health information resting on a server), must be consistent with the NIST Special Publication 800-111, Guide for Storage Encryption Technologies for End User Devices. Valid encryption processes for protected health information data in motion (e.g., transmitted through a network) are those which comply with NIST Special Publications 800-52, Guidelines for the Selection and Use of Transport Layer Security Implementation; 800-77, Guide to IPsec VPNs; or 800-113, Guide to SSL VPNs, or others which are Federal Information Processing Standards (FIPS) 140-2 validated.

4. Where Data is to be Stored. All data must be stored only on computer systems located in the continental United States. Requirement to Maintain Security Program. Contractor acknowledges that the City has implemented an information security program to protect the City's information assets, which Program is available on the City website at <http://www.cityofchicago.org/city/en/depts/doi/supp_info/is-and-it-policies.html> ("City Program"). Contractor shall be responsible for establishing and maintaining an information security program that is designed to: (i) ensure the security

Dofa Protection Requirements 283

and confidentiality of Protected Information; (ii) protect against any anticipated threats or hazards to the security or integrity of Protected Information; (iii) protect against unauthorized access to or use of Protected Information; (iv) ensure the proper disposal of Protected Information; and, (v) ensure that all subcontractors of Contractor, if any, comply with all of the foregoing.

6. Undertaking by Contractor. Without limiting Contractor's obligation of confidentiality as further described herein, in no case shall the safeguards of Contractor's information security program be less stringent than the information security safeguards used by the City Program.
7. Right of Audit by the City of Chicago. The City of Chicago shall have the right to review Contractor's information security program prior to the commencement of Services and from time to time during the term of this Agreement. During the performance of the Services, from time to time and without notice, the City of Chicago, at its own expense, shall be entitled to perform, or to have performed, an on-site audit of Contractor's information security program. In lieu of an on-site audit, upon request by the City of Chicago, Contractor agrees to complete, within forty-five (45 days) of receipt, an audit questionnaire provided by the City of Chicago or the City of Chicago's designee regarding Contractor's information security program.
8. Audit by Contractor. No less than annually, Contractor shall conduct an independent third-party audit of its information security program and provide such audit findings to the City of Chicago, all at the Contractor's sole expense.
9. Audit Findings. Contractor shall implement at its sole expense any remedial actions as identified by the City as a result of the audit.
10. Demonstrate Compliance - PCI. No less than annually, as defined by the City of Chicago and where applicable, the Contractor agrees to demonstrate compliance with PCI DSS (Payment Card Industry Data Security Standard). Upon City's request, Contractor must be prepared to demonstrate compliance of any system or component used to process, store, or transmit cardholder data that is operated by the Contractor as part of its service. Similarly, upon City's request, Contractor must demonstrate the compliance of any third party it has sub-contracted as part of the service offering. As evidence of compliance, the Contractor shall provide upon request a current attestation of compliance signed by a PCI QSA (Qualified Security Assessor).
11. Demonstrate Compliance - HIPAA / HITECH. If the Protected Information includes protected health information or electronic protected health information covered under HIPAA/HITECH, Contractor must execute, and be governed by, the provisions in its contract with the City regarding HIPAA/HITECH, the regulations implementing those Acts, and the Business Associate Agreement in its contract with the City. As specified in 1.3, protected health information must be secured in accordance with the "Guidance Specifying the Technologies and Methodologies that Render Protected Health Information Unusable, Unreadable, or Indecipherable to Unauthorized Individuals."
12. Data Confidentiality. Contractor shall implement appropriate measures designed to ensure the confidentiality and security of Protected Information, protect against any anticipated hazards or threats to the integrity or security of such information, protect against unauthorized access or disclosure of information, and prevent any other action that could result in substantial harm to the City of Chicago or an individual identified with the data or information in Contractor's custody.
13. Compliance with All Laws and Regulations Contractor agrees that it will comply with all laws and regulations.
14. Limitation of Access. Contractor will not knowingly permit any Contractor personnel to have access to any City of Chicago facility or any records or data of the City of Chicago if the person has been convicted of a crime in connection with (i) a dishonest act, breach of trust, or money laundering, or (ii) a felony. Contractor must, to the extent permitted by law, conduct a check of public records in all of the employee's states of residence and employment for at least the last five

1.10.

Data Protection Requirements

years in order to verify the above. Contractor shall assure that all contracts with subcontractors impose these obligations on the subcontractors and shall monitor the subcontractors' compliance with such obligations.

15. **Data Re-Use.** Contractor agrees that any and all data exchanged shall be used expressly and solely for the purposes enumerated in the Agreement. Data shall not be distributed, repurposed or shared across other applications, environments, or business units of Contractor. As required by Federal law, Contractor further agrees that no City of _ Chicago data of any kind shall be revealed, transmitted, exchanged or otherwise passed to other Contractors or interested parties except on a case-by-case basis as specifically agreed to in writing by an officer of the City of Chicago with designated data, security, or signature authority.
16. **Safekeeping and Security.** Contractor will be responsible for safekeeping all keys, access codes, passwords, combinations, access cards, personal identification numbers and similar security codes and identifiers issued to Contractor's employees, agents or subcontractors. Contractor agrees to require its employees to promptly report a lost or stolen access device or information to their primary business contact and to the City of Chicago Information Security Office.
17. **Mandatory Disclosure of Protected Information.** If Contractor is compelled by law or regulation to disclose any Protected Information, the Contractor will provide to the City of Chicago with prompt written notice so that the City of Chicago may seek an appropriate protective order or other remedy. If a remedy acceptable to the City of Chicago is not obtained by the date that the Contractor must comply with the request, the Contractor will furnish only that portion of the Protected Information that it is legally required to furnish, and the Contractor shall require any recipient of the Protected Information to exercise commercially reasonable efforts to keep the Protected Information confidential.
18. **Data Breach.** Contractor agrees to comply with all laws and regulations relating to data breach, including without limitation, the Illinois Personal Information Protection Act and other applicable Illinois breach disclosure laws and regulations. Data breaches of protected health information and electronic protected health information shall be governed by the provisions regarding HIPAA/HITECH, and the regulations implementing those Acts, in the Contractor's contract with the City, specifically the Business Associate Agreement in such contract. Contractor will immediately notify the City if security of any Protected Information has been breached, and will provide information as to that breach in such detail as requested by the City. Contractor will, if requested by the City, notify any affected individuals of such breach at the sole cost of the Contractor.
19. **Data Sanitization and Safe Disposal.** All physical and electronic records must be retained per federal, state and local laws and regulations, including the Local Records Act. Where disposal is approved, the Contractor agrees that prior to disposal or reuse of all magnetic media (e.g. hard disk, floppy disk, removable media, etc.) which may have contained City of Chicago data shall be submitted to a data sanitization process which meets or exceeds DoD 5220.28-M 3-pass specifications. Certification of the completion of data sanitization shall be provided to the City of Chicago within 10 days of completion. Acceptance of Certification of Data Sanitization by the Information Security Office of the City of Chicago is required prior to media reuse or disposal. All other materials which contain City of Chicago data shall be physically destroyed and shredded in accordance to NIST Special Publication 800-88, Guidelines for Media Sanitization, specifications.
20. **End of Agreement Data Handling.** The Contractor agrees that upon termination of this Agreement it shall return all data to the City of Chicago in a useable electronic form, and erase, destroy, and render unreadable all data in its entirety in accordance to the prior stated Data Sanitization and Safe Disposal provisions. Data must be rendered in a manner that prevents its physical reconstruction through the use of commonly available file restoration utilities. Certification in writing that these actions have been completed must be provided within 30 days of the termination of this Agreement or within 7 days of a request of an agent of the City of Chicago, whichever shall come first.

1.15.

Data Protection Requirements

EXHIBIT 8: NEW INFORMATION SECURITY POLICIES

Contractor shall at all times comply, and act in a manner that allows the City to maintain compliance, with the City's Information Security Policies, as they currently exist and as they may be amended from time to time, available on the City of Chicago Department of Innovation Technology

website,
<[http://www.cityofchicago.org/content/dam/city/depts/doi/supp%20info/IS%20and%20IT%20Policies/CoC IT IS Poli cv Set ver RC 05.pdf](http://www.cityofchicago.org/content/dam/city/depts/doi/supp%20info/IS%20and%20IT%20Policies/CoC%20IT%20IS%20Poli%20cv%20Set%20ver%20RC%2005.pdf)>, incorporated herein.

New Information Security Policies

EXHIBIT 9: EXISTING FIXTURE REMOVAL AND LED FIXTURE INSTALLATION SPECIFICATIONS

A/ore; Electrical Specifications referenced in this Exhibit may be found as part of Exhibit 1A. ITEM 1, REMOVE & INSTALL LUMINAIRE, LED, 120/240V, ALLEY WITH NEW WIRING HARNESS

- 1 DESCRIPTION. This item will consist of removal and disposal of existing alley luminaire and furnishing and installing a LED alley luminaire, conforming to Electrical Specification 1600, of the proper wattage and input voltage, with a new wiring harness, including an in-line fuse, on an alley light mast arm attached to an utility pole and spliced onto a CeCo secondary aerial wire distribution system at the location shown on the plans, or as directed by the Engineer.
- 2 REMOVAL. Removal will include all incidental work associated with the alley luminaire as directed by the Engineer. Contractor must keep a log listing all luminaires removed by block.

All luminaires removed by the contractor to be scrapped will become the property of the contractor and must be disposed of in full compliance with Environmental Protection Agency (EPA) regulations. The EPA Rule 40 CFR, part 273, finalized May 1995 established a guideline for the recycling of lamps and the mercury from scrapped lamps. Lamps bearing mercury may be classified as a potential hazardous waste.

The Contractor must recycle removed lamps to the extent possible and shall submit to the Engineer, for approval, the name and background of a qualified lamp recycling specialty service which must be used for recycling under this Contract. The Contractor shall provide the names of qualified facilities certified to dispose of used LAMP equipment at the pre-construction meeting.
- 3 MATERIAL. The luminaire must meet Electrical Specification 1600 for the lamp wattage and type of distribution specified. Luminaires to be either black or gray, or as specified by Commissioner. The wire must meet Electrical Specification 1351. The insulated copper wire will be 3-1/C No. 12 AWG wires with 150-degree C irradiated polyefin, insulation connected to the terminal board "line" terminals (Material and Scope of Work further defined Exhibit 10, Item #12]. All material will be subject to approval by the engineer
- 4 INSTALLATION. The luminaire must be securely installed on the mast arm. The vertical axis of the luminaire must be in a vertical plane, and the longitudinal axis must be leveled as specified in shop drawings supplied by the manufacturer to produce the desired distribution pattern.
- 5 METHOD OF MEASUREMENT. This work will be measured per each unit removed, disposed of and LED alley luminaire installed, complete. All wiring to feeder cable, including splices are included in this measurement.
- 6 BASIS OF PAYMENT. This work will be paid for at the contract unit price each in Exhibit 2A for a "Alley (New Wiring Harness)" of the proper wattage, voltage, and distribution type, which will be payment in full for furnishing, installing the unit complete in place.
ELECTRICAL SPECIFICATION 1600

Existing Fixture Removal and LED Fixture Installation Specifications

ITEM 2, REMOVE & INSTALL LUMINAIRE, LED, 120/240V, ALLEY (UTILIZING EXISTING WIRING HARNESS)

- 1 DESCRIPTION. This item will consist of removal and disposal of existing alley luminaire and furnishing and installing a LED alley luminaire, conforming to Electrical Specification 1600, of the proper wattage and input voltage, on an alley light mast arm attached to an utility pole and spliced onto a CeCo secondary aerial wire distribution system at the location shown on the plans, or as directed by the Engineer.
- 2 REMOVAL. Removal will include all incidental work associated with the alley luminaire as directed by the Engineer. Contractor must keep a log listing all luminaires removed by block.

All luminaires removed by the contractor to be scrapped will become the property of the contractor and must be disposed of in full compliance with Environmental Protection Agency (EPA) regulations. The EPA Rule 40 CFR, part 273, finalized May 1995 established a guideline for the recycling of lamps and the mercury from scrapped lamps. Lamps bearing mercury may be classified as a potential hazardous waste.

The Contractor must recycle removed lamps to the extent possible and shall submit to the Engineer, for approval, the name and background of a qualified lamp recycling specialty service which must be used for recycling under this Contract. The Contractor shall provide the names of qualified facilities certified to dispose of used LAMP equipment at the pre-construction meeting.

- 3 MATERIAL. The luminaire must meet Electrical Specification 1600 for the lamp wattage and type of distribution specified. Luminaires to be either black or gray, or as specified by Commissioner. All material will be subject to approval by the engineer.
- 4 INSTALLATION. The luminaire must be securely installed on the mast arm. The vertical axis of the luminaire must be in a vertical plane, and the longitudinal axis must be leveled as specified in shop drawings supplied by the manufacturer to produce the desired distribution pattern.
- 5 METHOD OF MEASUREMENT. This work will be measured per each unit removed, disposed of and LED alley luminaire installed, complete. All wiring splices and connections are included in this measurement.
- 6 BASIS OF PAYMENT. This work will be paid for at the fixture conversion contract unit price in Exhibit 2A each for a "Alley (Existing Wiring Harness)" of the proper wattage, voltage, and distribution type, which will be payment in full for furnishing, installing the unit complete in place.
ELECTRICAL SPECIFICATION 1600

Existing Fixture Removal and LED Fixture Installation Specifications

**ITEM 3, REMOVE & INSTALL LUMINAIRE, LED, 240V, RESIDENTIAL, STAGGERED ITEM 4, REMOVE & INSTALL LUMINAIRE, LED, 120V, RESIDENTIAL, LEGACY ONE SIDED ITEM 5, REMOVE & INSTALL LUMINAIRE, LED, 120V, RESIDENTIAL, LEGACY INTERSECTION ITEM 6, REMOVE & INSTALL LUMINAIRE, LED, 240V, ARTERIAL
ITEM 7, REMOVE & INSTALL LUMINAIRE, LED, 120V, PARK PATHWAY (COBRAHEAD OR SHOEBOX)**

- 1 DESCRIPTION. This item will consist of removal and disposal of existing luminaire and furnishing and installing a street lighting luminaire, conforming to Electrical Specification 1600, of the proper wattage and input voltage, on a street light mast arm attached to a street light pole, and connecting the unit to either an underground cable distribution system or an aerial wire distribution system at the location as directed by the Engineer.
- 2 REMOVAL. Removal will include all incidental work and items associated with the street lighting luminaire as directed by the Engineer. Contractor must keep a log listing all material removed by block. Care must be taken in disconnecting wires from the existing luminaire, as the existing wires must be used to connect the replacement equipment.
All material removed by the contractor to be scrapped will become the property of the contractor and must be disposed of in full compliance with Environmental Protection Agency (EPA) regulations. The EPA Rule 40 CFR, part 273, finalized May 1995 established a guideline for the recycling of lamps and the mercury from scrapped lamps. Lamps bearing mercury may be classified as a potential hazardous waste. The Contractor must recycle removed lamps to the extent possible and shall submit to the Engineer, for approval, the name and background of a qualified lamp recycling specialty service which must be used for recycling under this Contract. The Contractor shall provide the names of qualified facilities certified to dispose of used LAMP equipment at the pre-construction meeting.
- 3 MATERIAL. The luminaire must meet Electrical Specification 1600 for the LED type of distribution specified. Luminaires to be either black or gray, or as specified by Commissioner.
- 4 INSTALLATION. The luminaire must be securely installed on the mast arm. The vertical axis of the luminaire must be in a vertical plane,

and the longitudinal axis must be leveled as specified in shop drawings supplied by the manufacturer. Wire termination and connections to CECO will be paid for under separate pay item.

5 METHOD OF MEASUREMENT. This work will be measured per each unit removed, disposed of and new LED luminaire installed, complete. All wiring to the underground feeder cable, including splices, will not be included in this measurement.

6 BASIS OF PAYMENT. This work will be paid for at the fixture conversion contract unit price each in Exhibit 2A for a "Residential Legacy," "Arterial (Feeder) Legacy," "Residential Modern," "Arterial (Large)," "Arterial (Medium)," "Residential Intersection" of the proper wattage, voltage, and distribution type, which will be payment in full for furnishing, installing the unit complete in place.

ELECTRICAL SPECIFICATION

1600

Existing Fixture Removal and LED Fixture Installation Specifications

ITEM 8, REMOVE & INSTALL LUMINAIRE, LED, 240V, MID-MOUNT RESIDENTIAL ACORN ITEM 9, REMOVE & INSTALL LUMINAIRE, LED, 240V, MID-MOUNT ARTERIAL ACORN

1. DESCRIPTION. This work will consist of removal and disposal of mid-mount HPSV luminaire and furnishing and installing a LED mid-mount luminaire onto the mid-arm of a street light pole at approximately 10.5 feet from grade for residential street installation, and at 13 feet from grade for an arterial street installation, or as directed by the Engineer or as shown on the plans. The luminaire will provide pedestrian level lighting.
2. REMOVAL. Removal will include all incidental work and items associated with the alley luminaire as directed by the Engineer. Contractor must keep a log listing all material removed by block. Care must be taken in disconnecting wires from the existing luminaire, as the existing wires must be used to connect the replacement equipment.

All material removed by the contractor to be scrapped will become the property of the contractor and must be disposed of in full compliance with Environmental Protection Agency (EPA) regulations. The EPA Rule 40 CFR, part 273, finalized May 1995 established a guideline for the recycling of lamps and the mercury from scrapped lamps. Lamps bearing mercury may be classified as a potential hazardous waste.

The Contractor must recycle removed lamps to the extent possible and shall submit to the Engineer, for approval, the name and background of a qualified lamp recycling specialty service which must be used for recycling under this Contract. The Contractor shall provide the names of qualified facilities certified to dispose of used LAMP equipment at the pre-construction meeting.

3. MATERIAL. The LED luminaire for the residential installation must meet the requirements of Electrical Specification 1602, Standard Drawing 958 for residential and Electrical Specification 1603, Standard Drawing 912 for Arterial.
4. INSTALLATION. The luminaire must be securely mounted to the arm tenon with hex head set screws. The existing pole wire must be connected to the luminaire terminal block in an acceptable and approved manner.
5. METHOD OF MEASUREMENT. This work will be measured per each unit removed, disposed of and new LED mid-mount luminaire installed, complete and operational. All hardware and wire necessary to install the unit will be included.
6. BASIS OF PAYMENT. This work will be paid for at the contract fixture conversion unit price in Exhibit 2A for "Residential Coach," "Arterial Acorn," which price will be payment in full for furnishing and installing the unit.

3. ELECTRICAL SPECIFICATION

1602

Existing Fixture Removal and LED Fixture Installation Specifications

ITEM 10, REMOVE & INSTALL LUMINAIRE, LED, 120/240V, UNDERPASS VIADUCT & ELEVATED STRUCTURE

1. DESCRIPTION. This item will consist of furnishing and installing a street lighting luminaire, complete, conforming to Electrical Specification 1604, of proper wattage and input voltage, onto an underpass or elevated structure with bracket, beam clamps, channel and shock absorbers.
2. REMOVAL. Removal will include all incidental work and items associated with the alley luminaire as directed by the Engineer. Contractor must keep a log listing all material removed by block. Care must be taken in disconnecting wires from the existing luminaire, as the existing wires must be used to connect the replacement equipment.
All material removed by the contractor to be scrapped will become the property of the contractor and must be disposed of in full compliance with Environmental Protection Agency (EPA) regulations. The EPA Rule 40 CFR, part 273, finalized May 1995 established a guideline for the recycling of lamps and the mercury from scrapped lamps. Lamps bearing mercury may be classified as a potential hazardous waste. The Contractor must recycle removed lamps to the extent possible and shall submit to the Engineer, for approval, the name and background of a qualified lamp recycling specialty service which must be used for recycling under this Contract. The Contractor shall provide the names of qualified facilities certified to dispose of used LAMP equipment at the pre-construction meeting.
3. MATERIAL. The luminaire must meet Electrical Specification 1587. All bolts, washers, and nuts must be stainless steel, or other approved non-corrosive or suitably protected metal, and where necessary must be plated to prevent electrolytic action by contact with aluminum. Beam clamps and shock absorbers must be structurally sound. Compression springs will absorb luminaire movement in all directions. All material will be subject to approval by the engineer.
4. INSTALLATION. Installation will meet all applicable requirements of Section 801 and Section 821.03 & 821.06 of the Standard Specifications. The luminaire must be retrofitted onto existing holes. A metallic whip, of not more than six (6) feet, must be provided and installed from the luminaire to the nearest junction box, to provide a wireway. Wire termination and connections to CECO will be paid for under separate pay item.
5. METHOD OF MEASUREMENT. This work will be measured per each unit removed, disposed of and new LED luminaire installed, complete. All mounting hardware and labor will be included. Wiring from the luminaire to the controller will not be part of this item.
6. BASIS OF PAYMENT. This work will be paid for at the contract fixture conversion unit price each in Exhibit 2A for a "Viaduct," and mounting method, which will be payment in full for furnishing, installing the unit complete in place.

ELECTRICAL SPECIFICATION DRAWING

1604 981

Existing Fixture Removal and LED Fixture Installation Specifications

EXHIBIT 10: INFRASTRUCTURE STABILIZATION ITEMS SCOPES OF WORK AND SPECIFICATIONS

ITEM 1, REMOVE & INSTALL RESIDENTIAL POLE WIRE WITH GROUND ITEM 2, REMOVE & INSTALL ARTERIAL POLE WIRE WITH GROUND

1. DESCRIPTION. This item will consist of removing and disposal of existing pole wire & furnishing and installing new street lighting pole wire with ground. Pole wire will be removed as needed & installed from luminaire terminal block to the pole base.
2. REMOVAL. The existing pole wire will be removed and disposed of by the contractor as directed by the Engineer.
3. MATERIAL. The luminaire pole wire must meet Electrical Specification 1351. The ' insulated copper wire will be 3-1/C No. 12 AWG wires with 150 degree C. irradiated polyefin, insulation connected to the terminal board "line" terminals. All material will be subject to approval by the engineer.
4. INSTALLATION. The insulated pole wire must be connected to the terminal board "line" terminals. Pole wire installation must be color coded so that each lead of all circuits may be easily identified and lighting units connected to the proper leg as indicated on the plans.

They must extend through the mast arm raceway and down the inside of the pole to the pole base where they must be spliced to the underground feeder cables.

Green ground wire No. 12 must be connected to pole base bolt and to the system No. 8 ground cable. Sufficient wire must be supplied to extend the wires outside of the pole through the access handhole to permit splicing work to be performed outside the pole.
5. METHOD OF MEASUREMENT. This work will be measured per each unit removed & installed, complete. All mounting hardware, splices, and labor will be included. Wiring from the pole base to the controller will not be part of this item.
6. BASIS OF PAYMENT. This work will be paid for at the contract unit price each in Exhibit 2B for a REMOVE & INSTALL RESIDENTIAL POLE WIRE WITH GROUND; REMOVE & INSTALL ARTERIAL POLE WIRE WITH GROUND, which will be payment in full for removing and disposing of existing pole wire & furnishing, installing, connecting and testing the unit complete in place.

ELECTRICAL SPECIFICATION

1351

Infrastructure Stabilization Items Scopes of Work and Specifications

ITEM 3, REMOVE & INSTALL CABLE, ALUMINUM, AERIAL, 3-1/C #8, WITH MESSENGER

1. DESCRIPTION. This item will consist of removing and disposing of existing aerial cable & furnishing and installing an electrical cable, designated 'self-supporting', consisting of two insulated color coded conductors spirally wrapped around one bare conductor. The cable will be strung between two poles and attached to cable supports on these poles. The conductors will be connected to other wires or cables for the purpose of providing power for street lighting that would normally have underground cable feeds.
2. REMOVAL. The existing aerial cable must be removed and disposed of by the contractor as directed by the Engineer.
3. MATERIAL. The cable must meet the requirements of Electrical Material Specification 1601. The wire rack must

3. MATERIAL. The cable must meet the requirements of Electrical Material Specification 1601. The wire rack must meet the requirements of Electrical Material Specification 1443. Other materials are described herein.
4. INSTALLATION REQUIREMENTS. The cable must be installed with a nominal tension adequate to produce sag of approximately 9 inches in a 60 ft. span. The cable must be attached to the poles by means of suitable dead end clamps which hold the bare conductor. Each dead end clamp must be an aluminum wedge cable clamp assembly consisting of a flexible galvanized steel bale attached to an aluminum body. The body must consist of an aluminum channel with an aluminum wedge that can securely grip the #8 messenger. The clamp must be supported by a clamp support device known as a one-spool rack. The rack support device must consist of a clevis with a porcelain insulator spool attached to the clevis with a cotter pin. The clevis must be attached to the pole by appropriate stainless steel banding. The bare conductor must be trimmed at each clamp. The insulated conductors must be directed through the top of each pole to the base of the pole and spliced to the pole wires that feed the luminaire. The splices must be accessible through the pole door. Each splice will consist of 2 or more wires, trimmed of insulation and clamped together with an appropriate connector. The connector must be made for and approved for splicing aluminum and copper conductors together. The entire assembly will be placed in a mold and filled with epoxy resin making a secure and weatherproof splice. All splices will be rated for 600 volts. All splices should be designed to operate within a temperature range of -55° Celsius to 110° Celsius.
5. METHOD OF MEASUREMENT. This work will be measured per lineal foot of cable installed. Cable to be removed & installed must be measured by horizontal distances only from point to point, and will not include slack, sag, or other vertical dimensions.
6. BASIS OF PAYMENT. This work will be paid for at the contract unit price in Exhibit 2B per foot for furnishing and installing "CABLE, ALUMINUM, AERIAL, 3-1/C #8 WITH MESSENGER", which will be payment in full for removal, transport, disposal, and disposal fees and furnishing and installing this cable, including cable clamps, clevises, insulators, dead end devices, and splices, which will be considered incidental to this item.

MATERIAL SPECIFICATION

1601, 1443

Infrastructure Stabilization Items Scopes of Work and Specifications

ITEM 4, REMOVE & INSTALL ELECTRIC CABLE, AERIAL, 1/C # 6

L DESCRIPTION.

This item will consist of removing, disposing of & furnishing and installing electrical wire strung between poles, attached to secondary wire racks on the poles, and connected to other wires or cables for the purpose of extending street lighting circuits as shown on the plans, as specified herein, or as directed by the Commissioner.

2. REMOVAL. The material must be removed and disposed of by the contractor as directed by the Engineer.

3^ MATERIALS.

The material must be single conductor #6 AWG aerial wire meeting the requirements of Material Specification 1441 for medium hard-drawn copper aerial wire.

± INSTALLATION REQUIREMENTS.

The wire must be installed with a nominal tension of 150 pounds to produce a sag of approximately 6 inches in an 85-foot span. Through wire must be attached to the side of the insulator away from the pole and secured with four turns of a tie wire close wrapped. Dead- ends must have two wraps of the wire around the insulator and then six close turns of the wire around the wire under tension, or by the use of an approved automatic bail dead-end device. Where necessary, wire lengths will be spliced together by means of an approved automatic wedge-type, straight line splicing device. Each splice must be given two wrappings of friction tape and coated with insulating paint. Connections to lamp leads, or other conductors not under tension, must be made with approved

split-bolt connectors and wrapped with three layers of half-lapped of plastic, electrical tape and coated with insulating paint.

5. BASIS OF PAYMENT.

This work will be paid for at the contract unit price in Exhibit 2B per lineal foot for REMOVE & INSTALL ELECTRIC CABLE, AERIAL, 1/C # 6, existing cable disconnected and removed & for new cable installed in place and connected, which price will be payment in full for removing and disposing of & furnishing, installing and connecting #6 AWG aerial line wire in place.

MATERIAL SPECIFICATION

1441

Infrastructure Stabilization Items Scopes of Work and Specifications

ITEM 5, REMOVE & INSTALL ELECTRIC CABLE IN CONDUIT, TRIPLEX 2 1/C NO.6,1/C NO.8

1. DESCRIPTION This work will consist of removing, disposing of existing cable in conduit & furnishing and installing electric cable that is triplexed. The cable must be rated at 600 volts and must consist of two number 6 conductors and one number 8 conductor. The cable will be installed in conduit underground.
2. REMOVAL. The existing cable must be removed and disposed of by the contractor as directed by the Engineer.
3. MATERIAL The triplexed cable must meet all requirements of Material Specification 1534 of the CDOT Division of Engineering, City of Chicago.
4. CONSTRUCTION METHOD All cables must be installed with care to prevent damage to the cable. Any defects found in the cable must be reported to the resident engineer. Damaged cable must be replaced.

The cable must be pulled into the conduit with a minimum of dragging on the ground or pavement. This will be accomplished by means of reels mounted on jacks or other suitable devices located for unreeling cable directly into duct. Lubricants must be used to facilitate installation if deemed necessary by the contractor.

Bends in the cable will conform to the recommended minimum radii as outlined in the National Electric Code.

Cable passing through manholes must be trained and racked around the sides of the manhole into a permanent position. If racks are non-existent or in poor condition, the contractor must install racks. The material must be approved by the resident engineer. Any material and labor involved in training and racking the cable will be considered incidental to the cost of this pay item.

Where cable runs continue from manhole to manhole without tapping within a light pole, they will be continuous without splices unless authorized by the resident engineer.

The cable installation must be color coded so that each lead of all circuits may be easily identified and lighting units connected to the proper leg as indicated on the plans. The equipment grounding conductor (no. 8) must be color coded green.

All wire or cable in the distribution panels and control cabinets must be properly trained and have sufficient slack provided for any rearrangement of equipment or future additions.

There must be at least three feet of slack in a street light pole base or street light controller base. A handhole must have at least five feet of slack and a manhole at least ten feet of slack.

Infrastructure Stabilization Items Scopes of Work and Specifications

5. **METHOD OF MEASUREMENT** The length of the triplex cable furnished and installed will be measured as the length of conduit plus three feet for cable entering and leaving a light pole or street light control cabinet, plus any slack in manholes or handholes. The removal and disposal of the existing cable in conduit will be incidental to this pay item.
6. **BASIS OF PAYMENT** This work shall be paid for at the contract unit price in Exhibit 2B per lineal foot for **ELECTRIC CABLE IN CONDUIT, TRIPLEX 2 1/C NO.6, 1/C NO.8**. The price will be payment in full for furnishing, installing, and testing the cable, and will include all material, labor, terminations, and incidentals necessary to complete the work as per the contract plans. The removal & disposal of existing cable in conduit will be incidental to this pay item.

MATERIAL SPECIFICATION

1534

Infrastructure Stabilization Items Scopes of Work and Specifications

ITEM 6, REMOVE RESIDENTIAL LEGACY POLE & MAST ARM, INSTALL RESIDENTIAL 20' POLE & 12' MAST ARM ALUMINUM

1. DESCRIPTION. This item will consist of removing residential pole and mast arm, furnishing, installing, and setting plumb an aluminum anchor base pole and aligning an aluminum truss arm to which a street light luminaire will be attached. The pole & mast arm will be set on an existing foundation with anchor rods or bolts.
2. MATERIAL. The pole must meet the requirements of Material Specification 1452. In addition, the residential pole must meet the requirements and dimensions of Standard Drawing 890. The mast arm must meet the requirements and dimensions of Standard Drawing 943.
3. INSTALLATION. The pole must be installed on a concrete foundation or a steel helix foundation designed for the particular pole usage. When using double-nut construction please follow the details as shown on Standard Drawing 837. Double nut construction provides proper ventilation, as well as providing a way to plumb the pole. When using a helix foundation, double nutting is not feasible. Any exposed portions of anchor rods extending above the nuts which interfere with the installation of the bolt covers must be cut off to provide the necessary clearance. The excess must not be burned off. The pole must be set secure and plumb using the nuts and washer provided with the foundation pay item. The bolt covers, handhole cover, and pole cap must be securely attached. The mast arm must be installed on the aluminum pole as shown on the appropriate standard drawing. The truss arm must be attached to the pole by the clamping method • using the hardware provided. The pole must be properly orientated in relation to the street, so that the truss arm will be perpendicular to the direction of the roadway.
4. METHOD OF MEASUREMENT. This item will be measured per unit installed, complete with mast arm. Work will consist of attaching the pole to the foundation, application of nut covers and pole cap, attachment of handhole door, and plumbing of the pole.
5. BASIS OF PAYMENT. This work will be paid for at the Contract unit price each in Exhibit 2B for REMOVE RESIDENTIAL LEGACY POLE & MAST ARM, INSTALL NEW RESIDENTIAL 20' POLE & NEW 12' MAST ARM ALUMINUM which will be payment in full for furnishing and installing the pole and mast arm complete in place. The light standard foundation, truss arm, and luminaire will not be included in this pay item but will be paid for separately.

MATERIAL SPECIFICATION

1452 1453

DRAWINGS

837 890 943

Infrastructure Stabilization Items Scopes of Work and Specifications 297

ITEM 7, REMOVE ARTERIAL LEGACY POLE & INSTALL ARTERIAL STEEL, ANCHOR BASE, 15" B.C., 34'-6"

1. DESCRIPTION. This item will consist of removing an arterial pole, furnishing, installing, and setting plumb a steel anchor base pole to which equipment may be attached for the extension of the City street light. The pole &

mast arm (paid separately) will be set on an existing foundation with anchor rods or bolts.

2. MATERIAL. The material of the pole must meet the requirements of Material Specification 1447.
3. INSTALLATION. The pole must be installed on the concrete foundation designed for the particular pole usage as indicated on the plans or as directed by the Engineer. Double nut construction must be used as shown on Drawing 837. Double nut construction provides the proper ventilation, as well as providing a way to plumb the pole. Any exposed portions of anchor rods extending above the nuts which interfere with the installation of the bolt covers must be cut off to provide the necessary clearance. The excess must not be burned off. The pole must be set secure, properly orientated, and plumb using the nuts and washers provided with the anchor bolts. The bolt covers, handhole cover, and pole cap must be securely attached.

The contractor will utilize non-abrasive slinging materials and will otherwise exercise due care in erecting the pole and mast arm to minimize any possible damage to the finish. When necessary, the contractor will utilize, at his own expense, factory approved touch-up materials and methods to restore the finish to like new appearance and durability.

4. METHOD OF MEASUREMENT. This item will be measured per each unit installed, complete with anchor bolt covers, pole cap, and handhole cover.
5. BASIS OF PAYMENT. This work will be paid for at the Contract unit price each in Exhibit 2B for a REMOVE ARTERIAL LEGACY POLE & INSTALL ARTERIAL STEEL, ANCHOR BASE, 15" B.C., 34'-6", which will be payment in full for furnishing and installing the pole complete in place. Light standard foundations, mast arms, and luminaires will not be included in this pay item but will be paid for separately.

MATERIAL SPECIFICATION
1447

DRAWING
837 808

Infrastructure Stabilization Items Scopes of Work and Specifications

ITEM 8, REMOVE & INSTALL MAST ARM, STEEL, 8 FOOT

ITEM 9, REMOVE & INSTALL MAST ARM, STEEL, 12 FOOT

ITEM 10, REMOVE & INSTALL MAST ARM, STEEL, 15 FOOT

1. DESCRIPTION. This item will consist of removing, furnishing and installing a steel pipe mast arm of a specified length to support a street light luminaire, or other electrical equipment as required, as is shown on Drawing Numbers 620, 839, and 840.
2. MATERIAL. The material of the mast arm must conform to the requirements of Material Specification 1450. The 4-foot arm must conform to Standard Drawing 661. The 8-foot mast arm must conform to Standard Drawing 620. The 12-foot mast arm must conform to Standard Drawing 839. The 15-foot mast arm must conform to Standard Drawing 840. The two bolt arm attachment must be equal to that shown on Standard Drawing 724. The 1-foot mast arm will be a 4-foot arm cut to the desired length.
3. INSTALLATION. The 1 foot, 4 foot, and 8-foot mast arms will be installed with two bolts to the mast arm attachment on the pole. The pole must have a mast arm attachment as shown in Standard Drawing 659 in order to properly mount the arm. The truss arms require 2 such mounts. The 12 foot and 15-foot truss arms will be attached with 4 bolts. Bolts will be supplied with the arm per Material Specification 1450.

4. METHOD OF MEASUREMENT. This work will be measured per each unit installed.
5. BASIS OF PAYMENT. This work must be paid for at the contract unit price each in Exhibit 2B for a REMOVE & INSTALL MAST ARM, STEEL, of the length specified, which will be payment in full for furnishing and installing the mast arm complete in place.

MATERIAL SPECIFICATION

1450

DRAWING

620 839 840

January 23, 2004

Infrastructure Stabilization Items Scopes of Work and Specifications

ITEM 11, PLASTIC POLE DOORS

1. DESCRIPTION. This work will consist of installing a plastic pole door, in the field, on either a street light pole or a traffic pole where the handhole door is missing.
2. MATERIAL. The City will supply the plastic doors. There are 22 different door styles. Standard Detail Drawings 001 through 022 are included within this contract for clarification
3. INSTALLATION. The contractor must make arrangements with the City to pick up the plastic doors needed from the Division of Electricity's facility at 2451 South Ashland Avenue. The contractor will install the doors where needed, as directed by the City or where the contractor has discovered a missing door.
4. METHOD OF MEASUREMENT. This work will be measured per each door installed.
5. BASIS OF PAYMENT. This work will be paid for at the contract unit price in Exhibit 2B for each PLASTIC POLE DOOR, which payment will be in full for installing the door.

DRAWINGS

001 -022

October 27, 2016

Infrastructure Stabilization Items Scopes of Work and Specifications

ITEM 12, REMOVE & INSTALL ALLEY LUMINAIRE WIRE WITH IN-LINE FUSES

1. DESCRIPTION. This item will consist of removing and disposal of existing service wire & furnishing and installing new Alley street lighting wire with in-line fusing. Wire will be removed as needed & installed from luminaire terminal block to CeCo secondary lines.

The existing wire will be removed and disposed of by the contractor as directed by the Engineer.
2. MATERIAL. The wire must meet Electrical Specification 1351. The insulated copper wire will be 3-1/C No. 12 AWG wires with 150-degree C. irradiated polyefin, insulation connected to the terminal board "line" terminals. All material will be subject to approval by the engineer.
3. INSTALLATION. The wire must be connected to the terminal board "line" terminals. Wire installation must be color coded so that each lead of all circuits may be easily identified and lighting units connected to the proper leg. For aerial distribution, the primary wiring to the driver must consist of 3 1/C #12 AWG wires, connected to the terminal board "line" terminals. They must extend through the mast arm and exit from the mast arm through the grommet in the hole provided for this purpose, and extend further forming a drip loop and connect with the CeCo. Secondary wires. Connection to the aerial circuit wires must be made with a split bolt type pressure connector for a No. 6 solid copper wire and the connection so formed must be wrapped with two layers of an approved electrical tape. Inline fuses external must be provided to the luminaire to provide a proper disconnect from CeCo. Cartridge fuses type K.TK., rated at 10 Amperes must be provided.

METHOD OF MEASUREMENT. This work will be measured per each unit removed & installed, complete. All mounting hardware, splices, and labor will be included.
4. BASIS OF PAYMENT. This work will be paid for at the contract unit price in Exhibit 2B each for REMOVE & INSTALL ALLEY LUMINAIRE WIRE WITH IN-LINE FUSES which will be payment in full for removing and disposing of existing pole wire & furnishing, installing, connecting and testing the unit complete in place.

ELECTRICAL SPECIFICATION

1351

Infrastructure Stabilization Items Scopes of Work and Specifications

**ITEM 13, PAINT BOTTOM 5' OF EXISTING POLE TO INHIBIT RUST CORROSION
ITEM 14, PAINT EXISTING 20' RESIDENTIAL POLE ITEM 15, PAINT EXISTING
30' ARTERIAL POLE ITEM 16, PAINT EXISTING 8' MAST ARM ITEM 17, PAINT
EXISTING 12' OR 15' MAST ARM**

1. DESCRIPTION. This work will consist of field painting existing steel structures including poles and arms that support street lights and traffic control signals. This scope of work is not intended aesthetic purposes; the primary goal is to inhibit the progression of rust and extend the useful life of lighting infrastructure. Traffic signal equipment attached to arterial poles will not be included in this scope of work.
2. MATERIAL. All paints and painting materials intended for applications specified herein must be certified by the contractor to be of highest quality, must be from the same manufacturer, and must conform to the following, as applicable:
 - (a) Naptha. The solvent to be used for wiping down all metallic surfaces prior to application of paint must be NAPHTHA conforming to ASTM Standard D838.
 - (b) Primer. This paint must meet the requirements of Section 4 (composition) and Section 5 (properties) of the Steel Structures Painting Council's Paint Specification No. 25 for red iron oxide, zinc oxide, raw linseed oil and alkyd primer as outlined in Volume 2, Systems and Specifications. Third Edition.
 - (c) Intermediate Coat. The paint must meet the same requirements as the primer except that it will contain a contrasting shade of iron oxide/ or be tinted or shaded to produce a distinct contrast of at least 10 Hunter Delta E units compared to the primer.
 - (d) Finish Coat. This paint must meet the requirements of Section 4 (composition) and Section 5 (properties) of the Steel Structures Painting Council's Paint Specification No. 21 for lead free white or colored silicone alkyd paint, Type 1, high gloss as outlined in Volume 2, Systems and Specifications, Third Edition.
 - (e) Color. A paint sample must be submitted for approval prior to authorization to paint. The color will be as specified by the City. The sample must be in the form of a 4" by 8" color chip. The contractor must provide a field-painted sample, if requested by the Commissioner. The field sample must be of the same type of equipment to be painted and will

Infrastructure Stabilization Items Scopes of Work and Specifications 302

be chosen by the Commissioner. Color will be green, gray, black, or another color as specified.

- (f) Product Data. The contractor must submit the manufacturer's technical information, label analysis, and application instructions for each material proposed for use. Each material must be listed and cross-referenced for the specific coating, finish system, and application. Each material must include the manufacturer's catalog number.
3. DELIVERY, STORAGE, AND HANDLING. The contractor must deliver, store, and handle the paint as herein specified.
 - (a) The materials must arrive at the job site in the manufacturer's original, unopened packages and containers bearing the manufacturer's name label, product name, product description, manufacturer's stock number,

date of manufacture, contents by volume for pigment and vehicle constituents, thinning instructions, application instructions, and color name and number.

- (b) Materials to be stored should be kept in tightly covered containers in a well ventilated area at a minimum ambient temperature of 45° Fahrenheit.

4. **PREPARATION OF SURFACES.**

- (a) **Steel Surfaces.** Remove loose or scaling paint, dirt, oil grease, rust and foreign matter, as necessary, to receive paint. Wire brushing, where specified herein, must be done with an approved power tool operated from a portable power source. After wire brushing, the complete surface must be thoroughly wiped with a rag containing NAPTHA.
- (b) **Weather Conditions.** Do not apply paint coatings when temperature is below 40° F, or during periods of rain, fog, snow, or when relative humidity is above 85 %.
- (c) **Application Conditions.** Surfaces to be painted must be clean, dry, and relatively smooth. Each paint coating must be applied smoothly and worked out evenly. Paint must be thoroughly mixed just prior to application. Thinning must be held to a minimum, and must be done only when required for proper application. Thinners to be used will be the manufacturers recommended thinner for the paints used; mixed thoroughly to assure complete blending with the coating. Spray painting will not be permitted when wind conditions are greater than 15mph. Painting must be done as soon after cleaning as possible.

5. **DETAIL PAINTING REQUIREMENTS.**

Infrastructure Stabilization Items Scopes of Work and Specifications

- (a) **Street Light Poles.** Street light poles to be painted under these specifications are steel structures which will vary in the degree of existing rusting and/or bare spots which the contractor will be required to thoroughly wire-brush. The surface to be painted must be exhaustively wiped with NAPTHA, and the finish coating applied.
- (b) **Mast Arm Brackets.** Mast arms which are attached to the street light poles will consist of 2-inch steel pipe sections which will vary between eight feet (8') and fifteen feet (15') in length. Mast arms in twelve foot (12') and 15 foot (15') sizes will have a supporting strut of two inch (2") steel pipe. Surface scale and rust will be wire-brushed, and these mast arms thoroughly wiped with NAPTHA, and finish painted.

6. **BASIS OF PAYMENT.**

This work will be paid for at the contract unit price for in Exhibit 2B each PAINT BOTTOM 5' OF EXISTING POLE, PAINT EXISTING 20' RESIDENTIAL POLE, PAINT EXISTING 30' ARTERIAL POLE, PAINT EXISTING 8' MAST ARM, PAINT EXISTING 12'MAST ARM, PAINT EXISTING 15'MAST ARM, OR which will be payment in full for all labor and materials necessary in painting the existing equipment.

Infrastructure Stabilization Items Scopes of Work and Specifications

ITEM 18, GALVANIZED STEEL CONDUIT ATTACHED TO STRUCTURE 3/4"

1. DESCRIPTION This work will consist of furnishing and installing electrical conduit of the type and size specified herein. If replacing existing conduit, this work also includes the removal and proper disposal of the existing conduit being replaced.
2. **MATERIALS**
Galvanized rigid steel conduit, fittings, condulets, and junction boxes must conform to the requirements of Material Specification 1462.
3. **CONSTRUCTION.** Galvanized rigid steel conduit may be installed attached to a structure. The Contractor must exercise care in installing the conduit to ensure that it is smooth, free from sharp bends or kinks, and has the minimum practicable number of bends. Crushed or deformed conduit will not be accepted. All conduit, condulets, junction boxes and fittings must have the burrs and rough places smoothed, and all conduit runs must be cleaned and swabbed before installation of electric cables. If cable is not to be installed immediately after cleaning of the conduit, a light weight pulling line such as 1/8" polyethylene line must be placed in the conduit and will remain in the conduit for future work.

(3") or smaller conduit laterals can be laid on a single, horizontal level. Four or more conduit laterals must be installed on two (2) levels in accordance with instructions of the Resident Engineer.

Conduit laterals attached to a structure must be flush to the structure where possible. Clamps or hangers must be used at a maximum interval of five feet (5') to hold the conduit rigidly in place. Fittings, condulets, and junction boxes must be supplied and installed that are compatible with the conduit in use. Expansion couplings must be used at locations where the conduit crosses expansion joints in the structure.

Conduit laterals installed under vaulted walks must be securely attached to the retaining wall by means of galvanized clamps and clamp backs held in place by anchor bolts. Laterals will be fastened as close to the

underside of the sidewalk as possible, and securing clamps installed every five feet (5'). Laterals must be continuous through party walls.

Threaded fittings and bends of the same material as conduit must be furnished and installed as required. Threadless couplings may be used only for splicing existing conduit. All conduit splices, where required, will be considered incidental to this pay item.

4. METHOD OF MEASUREMENT. The length measured will be the number of lineal feet of conduit installed and accepted, measured in place. Each conduit will be measured separately even if in a single trench. The length for

Infrastructure Stabilization Items Scopes of Work and Specifications 305

measurement will be the distance horizontally between changes in the direction of the conduit plus the conduit vertically attached to structures. All conduits on structures will be measured from point to point, whether vertical or horizontal.

5. BASIS OF PAYMENT. This work will be paid for at the contract unit price in Exhibit 2B per lineal foot for GALVANIZED STEEL CONDUIT ATTACHED TO STRUCTURE 3/4", which price will be payment in full for furnishing and installing the conduit, condulets, junction boxes, and fittings complete. Cleaning, swabbing, and p-lining of new conduit will be incidental to this pay item. Hangers, clamps, and fittings for conduit attached to structure will be incidental to this item.

MATERIAL SPECIFICATION

1462

Infrastructure Stabilization Items Scopes of Work and Specifications

ITEM 19, ELECTRIC CABLE IN CONDUIT, 1/C #10

1. Description. This work will consist of furnishing and installing electric cable as specified. The cable will be installed in electrical conduit. If replacing existing wiring, this work also includes the removal and proper disposal of the existing wiring that is being replaced.
2. Material. The cable must meet all requirements of Material Specification 1534 of the Bureau of Electricity, City of Chicago.
3. Construction Method. All cables must be installed with care to prevent damage to the cable. Any defects found in the cable must be reported to the resident engineer. Damaged cable must be replaced.

The cable must be pulled into the conduit with a minimum of dragging on the ground or pavement. This will be accomplished by means of reels mounted on jacks or other suitable devices located for unreeling cable directly into duct. Lubricants must be used to facilitate installation if deemed necessary by the contractor.

Bends in the cable will conform to the recommended minimum radii as outlined in the National Electric Code.

All wire or cable in the distribution panels and control cabinets must be properly trained and have sufficient slack provided for any rearrangement of equipment or future additions.

4. Method of Measurement. The length of cable furnished and installed will be measured as the length of conduit plus three feet for cable entering and leaving a light structure or street light control cabinet.
5. Basis of Payment. This work will be paid for at the contract unit price in Exhibit 2B per lineal foot for ELECTRIC CABLE IN CONDUIT 1/C #10. Such price will be payment in full for furnishing, installing, and testing the cable, and will include all material, labor, terminations, and incidentals necessary to complete the work as per the contract plans.

MATERIAL

1534

ELECTRICAL SPECIFICATION 1351

Infrastructure Stabilization Items Scopes of Work and Specifications 307

**DIVISION OF ENGINEERING DEPARTMENT OF
TRANSPORTATION CITY OF CHICAGO REVISED AUGUST 27, 2013**

WIRE: SINGLE CONDUCTOR NO. 12 COPPER WITH CROSS LINKED POLYETHYLENE
INSULATION

SUBJECT

1. This specification states the requirements for insulated wire intended for use as a conductor to connect street light luminaires to aerial distribution wires or underground distribution cables in a street lighting circuit. This wire is also known as pole wire.

GENERAL

2. (a) Specifications. The cable shall conform in detail to the requirements herein stated and to the latest referenced specifications of the following organizations:
- American Society for Testing and Materials (ASTM) Insulated Cable Engineers Association (ICEA) National Electric Code (NEC)
National Electrical Manufacturers Association (NEMA) Underwriters Laboratories (UL)
- (b) Acceptance. Cable not conforming to this specification will not be accepted.
- (c) Sample. If requested by the Chief Procurement Officer, a three (3) foot sample of the cable intended to be provided under this specification, shall be submitted to the Engineer of Electricity within fifteen (15) business days after receipt of the request.
- (d) Warranty. The manufacturer shall warrant the cable to be first class material throughout. The manufacturer will be responsible for any cable failing during normal and proper use within one (1) year after the date of installation. The manufacturer will provide replacement of any failed cable segment, from the point of normal termination to the next point of normal termination. There will be no cost to the City.
- (b)

Infrastructure Stabilization Items Scopes of Work and Specifications

CABLE

3. (a) Construction. The cable shall consist of an uncoated copper conductor concentrically encased in a moisture resistant thermosetting plastic of cross linked polyethylene. The cable shall be listed with UL as Type RHW-2 or Type USE-2, and shall meet the NEC's requirements for these types of cable up to 90° C in wet or dry locations.
- (b) Color. Cable will be either black, red, or green.
- (c) Marking. The cable must be identified by a permanently inscribed legend in white lettering. The legend must have the following information at a minimum: 1/C #12AWG, 600V, XLPE, 90°, RHW-2 or USE-2, manufacturer's name, date of manufacture. The legend must be repeated at approximately eighteen inch (18") intervals parallel to the longitudinal axis of the cable.

- (d) Overall cable diameter shall be approximately 0.19 inches.

CONDUCTOR

4. (a) Material. Conductor shall be Number 12 AWG consisting of seven (7) strands of uncoated copper wires (.0305-inch diameter) per ASTM-B3.
- (b) Resistivity. Conductor shall conform to the requirements of ASTM B-33.

INSULATION

5. (a) Type. The insulation shall be a cross linked polyethylene compound meeting the physical and electrical requirements herein specified and the requirements of NEMA WC-70 (ICEA S-95-658).
- (b) - Thickness. The insulation must be circular in cross section and have an average thickness of 45 mils. The thickness must not vary by more than plus or minus five percent (+1-5%).*

TESTS

6. (a) General. The tests required to determine compliance with this specification must be certified by the manufacturer or an independent testing facility. Before shipment, copies of the test reports must be forwarded to the Division of Engineering for approval. The City reserves the right to reject any cable failing to meet the requirements of the tests. Tests must be made in accordance with methods in ASTM D-470.

(b) Physical Properties

Infrastructure Stabilization Items Scopes of Work and Specifications

(c) (d)

(e) (f)

PACKING

7. (a)

(b)

Initial Values:

Tensile strength, minimum psi 2000 Elongation at rupture, minimum % 250

After Aging:

After 168 hours in an air oven at 121° +/-1°C:

Tensile strength, minimum % of initial value 80 Elongation at rupture, minimum % of initial value 80

Modulus Test. After initial conditioning period of four (4) minutes at a temperature of 150° C and at 100% elongation, the modulus must not be less than 110 pounds per square inch.

Accelerated Water Absorption Characteristics.

1. Electrical Method. After twenty-four (24) hours immersion in tap water at 75° +/- 1° C, the specific inductive capacity of the insulation must not be more than 7. After a continued fourteen (14) day immersion, the specific inductive capacity must not be more than three percent (3%) higher than the value determined at the end of the first day, nor more than two percent (2%) higher than the value determined at the end of the seventh day.

2. Gravimetric Method. The insulation must not absorb more than live (5) milligrams of water per square inch of exposed surface area after immersion in distilled water at 70° C for a period of seven (7) days.

Electrical Characteristics. Each completed length of insulated conductor must withstand a test voltage of 3000 volts AC for a period of five (5) minutes after immersion in water for not less than six (6) hours and while still immersed. After withstanding this dielectric test, the cable must have an insulation resistance constant of not less than 25.000.

Cold Bend Test. The cable must pass the cold bend, long-time voltage test on short specimens as outlined in ASTM D-470.

Scaling. Both ends of each length of cable must be thoroughly sealed to prevent the entrance of moisture and other foreign matter.

The cable must be delivered in coils containing five hundred (500) feet each. Each coil must be packed in individual dispenser cartons. Each

Infrastructure Stabilization Items Scopes of Work and Specifications

carton must be labeled, identifying the cable type and size, manufacturer, and date of manufacture.

Infrastructure Stabilization Items Scopes of Work and Specifications

**ELECTRICAL SPECIFICATION 1441 DIVISION OF ENGINEERING
DEPARTMENT OF TRANSPORTATION CITY OF CHICAGO
REVISED JULY 31, 2013**

CABLE: SINGLE CONDUCTOR AERIAL, #6 AWG

WEATHERPROOFED

WITH POLYETHYLENE JACKET

SUBJECT

1. This specification states the requirements for cable intended to be used in overhead distribution on insulators for 240 VAC, 60 cycle, single phase, street lighting circuits. The cable is weatherproofed.

GENERAL

2. (a) Specifications. The cable shall conform in detail to the requirements herein stated, and to the specifications and methods of test of the Insulated Cable Engineer's Association (ICEA) and the American Society for Testing and Materials (ASTM), cited by number, in which the most recently published revisions will govern.
 - (b) Acceptance. Cable not conforming to this specification will not be accepted.
 - (c) Sample. A three-foot sample of the cable intended to be furnished shall be submitted within fifteen (15) business days after receipt of such a request from the Chief Procurement Officer. The sample must be sent to the Engineer of Electricity unless otherwise directed.
 - (d) Warranty. The manufacturer shall warrant the cable to be first class material throughout. In lieu of other claims against them, if the cable is installed within twelve (12) months of date of shipment, the manufacturer must replace any cable failing during normal and proper use within two years of date of installation. The Commissioner will be the sole judge in determining if a cable section needs to be replaced. The length of replacement will be the entire length of unspliced cable from existing termination/splice point to termination/splice point All replacements under this warranty shall be made free of charge F.O.B. delivery point of the original contract.

(b)

Infrastructure Stabilization Items Scopes of Work and Specifications

CONSTRUCTION

3. (a) The cable must have a copper conductor with a tight fitting concentric layer of polyethylene.
- (b) Conductor. The conductor must be made up of medium hard drawn, solid, round copper wire meeting the requirements of ASTM B-2. The conductor must be size 6, American Wire Gauge.
1. (c) Cover. The cover must be polyethylene. It must be circular in cross-section, concentric to the conductor, and must have an average thickness of 30 mils. The minimum thickness at any cross section must not be less than ninety percent (90%) of the average thickness.

PHYSICAL AND ELECTRICAL REQUIREMENTS

4. The cable must meet the physical and electrical requirements of ICEA S-70-547.

PACKAGING

5. (a) Cable Marking. The cable must be identified by a permanently inscribed legend in white lettering as follows:

1/C No. 6 AWG - WEATHERPROOFED AERIAL PE

The legend shall be repeated at approximately eighteen (18) inch intervals on the outside surface of the cable parallel to the longitudinal axis of the conductor. A sequential footage marking must be located on the opposite side from the legend.

- (b) Reels. The completed cable shall be delivered in lengths of 1000 feet in coils with a nominal 21-inch eye opening. Both ends of each length of cable shall be properly sealed against the entrance of moisture and other foreign matter by the use of clamp-on cable caps. The ends shall be securely fastened so as not to become loose in transit.

Before shipment, heavy cardboard or plastic wrapping shall be applied to all coils. Coils must then be fastened to 48 inch by 48-inch hardwood 4-way non-returnable pallets for shipment. Total height of each pallet must not exceed 64 inches. Total weight of each pallet must not exceed

Infrastructure Stabilization Items Scopes of Work and Specifications

2200 pounds.

- (c) Marking. A metal tag must be securely attached to each pallet indicating the coil number, contract number, date of shipment, gross and tare weights, City Commodity Code number if applicable, footage, and a description of the cable. Directions for unrolling the cable and any other pertinent information must be placed on each coil package with an approved permanent marking material such as oil-based paint or a securely attached metal tag.

Infrastructure Stabilization Items Scopes of Work and Specifications

**ELECTRICAL SPECIFICATION 1443 DIVISION OF ENGINEERING
DEPARTMENT OF TRANSPORTATION CITY OF CHICAGO REVISED
OCTOBER 26, 2016**

SECONDARY RACK, 1, 2 OR 3 WIRE, WITH INSULATORS

SUBJECT

1. This specification covers the requirements for 1, 2 and 3 wire secondary racks complete with insulators for attachment to street lighting poles for the purpose of supporting aerial circuit wires.

GENERAL

2. (a) Specifications. Each secondary rack shall conform in detail to the requirements herein stated, and to the specifications of the American Society for Testing and Materials, cited by ASTM Designation number, of which the most recently published revision will govern. Secondary racks not conforming to this specification will not be accepted.
- (b) Sample. If requested, each bidder shall submit with his proposal one complete sample secondary rack with insulators for approval by the Commissioner. The sample must be submitted within fifteen (15) business days of such request from the Chief Procurement Officer.
- (c) Warranty. Secondary rack and pole clamps furnished under this specification shall be warranted against failure from defects due to materials or workmanship for a period of one year after delivery, in the event of failure of any of the components, the manufacturer will replace the rack, at no cost to the City.

SECONDARY RACK

3. (a) General Design. The secondary rack shall be the medium duty type with extended back. It shall be suitable for either 1, 2 or 3 wire, as indicated in the bid proposal, with 8-inch spacing between centers of the clevises.
- (b) Back Section. The back section of the secondary rack must be made from hot-wrought merchant quality carbon steel 1/8 inch thick. The steel must conform with ASTM Specification A 575, Grade M1010. The back must be formed to the shape of an inverted trough, the flat portion of which

Infrastructure Stabilization Items Scopes of Work and Specifications

must be approximately 1-1/4 inches in width. Mounting slots, 11/16 inch by 1-1/4 inch, must be longitudinally centered on the Hat of the back section and located so as to coincide with the centers of the clevises, with additional slots provided at the top and bottom. The 2-wire back must be at least 18 inches in length. The 3-wire back must be at least 24 inches in length.

(c) Clevises. Clevises must be made from 1/8-inch-thick steel strip of the same material as the back section, and so formed to fit the back snugly. The prongs of the clevis must be approximately 4 inches apart and formed to the shape of an inverted trough, the flat portion of which must be approximately 3/4 inch in width with the edges pitched at an angle of 30° with the flat portion. Each clevis shall be fabricated in such a manner that the pitched edges of both prongs must slope in the same direction. The clevises must be riveted to the back section with two (2) 5/16-inch steel rivets.

(d) Rack Bolt. The rack bolt must be a 9/16-inch diameter button head bolt made of hot-wrought carbon steel conforming with the requirements of ASTM Specification A 576, Grade 1040, complete with a 1/4 inch by 2-inch brass cotter pin at the bottom end. Centerline of the rack bolt must be located 4 inches out from the face of the back section.

(c) Spool Insulators. Spool insulators must be electrical grade white or gray glazed porcelain.

(f) After fabrication, the secondary rack, clevises, and all steel hardware must be hot dip galvanized according to ASTM 123. Bolts, washers, and nuts must be hot dipped galvanized according to ASTM 153.

Infrastructure Stabilization Items Scopes of Work and Specifications

**ELECTRICAL SPECIFICATION 1447 DIVISION OF
ENGINEERING DEPARTMENT OF TRANSPORTATION CITY OF
CHICAGO REVISED MARCH 20, 2007**

POLE: ANCHOR BASE, 3 AND 7 GAUGE, TAPERED TUBULAR STEEL, WITH
HANDHOLE ENTRY

SUBJECT

1. This specification states the requirements for tapered, tubular, 3 gauge and 7-gauge steel anchor base poles with mast arm supports. They will support street light luminaires and/or traffic signal mast arms and will be served by underground cables.

GENERAL

2. (a) Specifications. The poles shall conform in detail to the requirements herein stated, and to the requirements of the following organizations cited herein, of which the most recent revisions shall govern:

American Association of State Highway and Transportation Officials (AASHTO)
American National Standards Institute (ANSI) American Society for Testing and
Materials (ASTM) American Welding Society (AWS) Society for Protective
Coatings (SSPC)

- (b) Acceptance. Poles not conforming to this specification will not be accepted.
- (c) Bidders Drawings. Bidders shall submit with their bids detailed scale drawings of the mast showing actual dimensions, details, and welds. Shop drawings must be original engineering drawings created by the manufacturer. The drawings must show every dimension necessary to show how all parts will fit each other and be properly held in assembly.
- (d) Drawings. The drawings mentioned herein are drawings of the Department of Transportation being an integral part of this specification cooperating to state necessary requirements.

- (e) Sample. If requested by the Chief Procurement Officer, one completely assembled anchor-base pole of the manufacture intended to be furnished, must be submitted for review within fifteen (15) business days of receiving the request.

(b)

Infrastructure Stabilization Items Scopes of Work and Specifications

- (t) Warranty. The manufacturer shall warrant the performance and construction of the light poles to meet the requirements of this Specification and must warrant all parts, components, and appurtenances against defects due to design, workmanship, or material developing within a period of five years after the light poles have been delivered. This will be interpreted particularly to mean structural or mechanical failure of any element or weld, or failure of any portion of the painting system. The warranty must be furnished in writing guaranteeing material replacement including shipment, free of charge to the City. The Commissioner will be the sole judge in determining which replacements are to be made and the Commissioner's decision will be final.

STANDARDS

3. (a) Assembly. Each anchor base pole shall consist of a steel mast with handhole entry, entry door with machine screws, grounding nut, mast base plate, top cap for mast, two (2) mast arm supports, bolt covers, and all necessary hardware required for complete assembly of these parts, ready for assembly, without special tools.

(b) Interchangeability. Members of each pole type shall be mutually interchangeable for assembly, so that no reworking will be required to make any member fit properly in the place of any other similar member of any other similar pole.

(c) Design. Each pole type shall conform in design and dimensions to the pertinent drawing(s) listed in Table "A".

MASTS

4. (a) Mast Size. The outside diameters of the mast of each pole type shall be as listed in Table A. The mast must be tapered at 0.14 inches per foot.

(b) Material. The mast must be fabricated from one length of No. 3, No. 7, or No. 11 Standard gauge steel meeting the material requirements of ASTM A606 for low alloy high strength coil steel, which, after fabrication, must possess an ultimate tensile strength of not less than 70,000 psi and a yield strength of not less than 60,000 psi, in accordance with ASTM A595, Grade C. Chemistry of the steel must be such as to insure resistance to atmospheric corrosion superior to that of ordinary copper bearing steel. Material certification is required. Manufacturer's steel meeting the specified physical and chemical requirements, and approved by the Commissioner, will be accepted.

(c) Fabrication. The mast must be fabricated with not more than one

Existing Fixture Removal and LED Fixture Installation Specifications

- (1) longitudinal weld. The weld shall be ground smooth so that it is virtually invisible. There shall be no

lateral welds in the masts other than where the masts are welded to the steel bases. Each mast must be straight and centered on its longitudinal axis. Each mast must be formed on a mandrel and worked to form a round cross-section. The completed, unpainted masts shall have smooth external surfaces free from protuberances, dents, cracks or other imperfections marring their appearance.

(d) Base. The mast base shall be a steel plate, of low alloy, high strength steel as noted in Par. 4 (b).

Plate Base. The base plate for each pole type shall be as listed in Table "A". It must be fabricated from the same ASTM A606 low alloy; high strength steel as is used for the mast. After fabrication the steel must meet the requirements of ASTM A588. The mast must be inserted into the base to a maximum depth which will still allow for an adequate weld to be made between the bottom of the mast and the plate. A circumferential weld must be made between the mast and the base at both the top and underside of the plate. Non-metallic removable bolt covers which completely cover the anchor bolts and nuts shall be provided. The covers must be attached with stainless steel screws coated with a non-seizing compound, or another type of non-seizing fastener, as approved by the Commissioner. The covers shall enclose the anchor bolts and be secured in an approved manner. The base shall be attached to the mast so that the bearing surface of the base is at right angles to the longitudinal axis of the mast. The vertical center line of the seam must be positioned so that no welds for the simplex attachments or the handhole opening will go through the seam.

Anchor Rod Openings. All anchor rod openings for each pole type shall have a width as listed in Table "A". Each opening must be sized to have a circumferential slot length equal to 15° of the circumference.

Infrastructure Stabilization Items Scopes of Work and Specifications

(e) Mast Arm Support Plates. The mast arm support plates will be made of cast steel conforming to the requirements for Grade 65-35 cast steel of ASTM A27, or equivalent, subject to approval. They shall neatly fit the external surface of the mast. The upper mast arm support plate must have a hollow protuberance, the hole of which must be approximately equivalent to two (2) inches in diameter, extending into the interior of the pole providing a smooth surface for the lamp cables to rest upon. The mast arm support plates shall be designed so that they will carry the mast arm and hold it in the proper position for fastening the mast arm to the mast. The design of the mast arm support plates must be a two (2) bolt type as shown on Standard Electrical Drawing No. 659.

(f) Provision for Ground. A 1/2-13 UNC (unified thread - course ANSI B1.1) square nut must be welded to the inside of the mast on the handhole entry frame for a ground connection.

(g) Entry. A vertical doorframe carrying a removable door providing access to the interior of the mast must be welded into a close fitting opening centered approximately 15 inches above the bottom of the base. The doorframe must be formed and welded of steel with a cross section of two and one-quarter (2-1/4) inches wide by one-quarter (1/4) inch thick so as to adequately reinforce the opening of the mast. The internal horizontal clearance of the doorframe must be four and three-quarter (4-3/4) inches; its internal vertical clearance must be seven (7) inches. Its upper and lower ends must be semi-circular meeting its straight sides tangentially. The radius of this opening must be two and three-eighths (2-3/8) inches. The vertical center line of the entry must be at a right angle clockwise from the vertical center line of the mast arm supports. The frame must have two welded tabs; one at the top and one at the bottom of the door frame. These tabs must be drilled and tapped to accept a 1/4-20 UNC screw. The top hole must be located 13/16 of an inch from the top of the opening. The bottom hole must be located 13/16 of an inch from the bottom of the opening. The 1/4-20 UNC machine screws must be stainless steel with hex heads, meeting the requirements of ASTM A193. The screws shall be treated with a compound to prevent seizing. Other non-seizing types of screws and fasteners may be considered. An alternate method of attachment consisting of a removable hinge on the bottom with a screw connection at the top may be considered. (The above requirements apply to all pole masts except those with a 10-inch bolt circle. Poles with 10-inch bolt circles must have handhole openings of 3" by 5". All other requirements apply.)

(h) Door. The removable door must be formed of sheet steel approximately one-eighth (1/8) inch thick. It shall be flat or dished depending upon the pole type, and tit the doorframe closely so that it will stay in proper position even if its locking screws are slightly loosened.

Existing Fixture Removal and LED Fixture Installation Specifications

The door must be drilled top and bottom to accept the 1/4-20 UNC hex head machine screws which will fasten the door to the doorframe. A half-circle piece of steel must be welded by the screw opening, to allow only a socket wrench to be used. All doors shall be interchangeable. An alternate method of attachment using an internal hinge at the bottom of the door with a screw at the top of the door will be considered. Any alternate method will be subject to approval by the Commissioner or his duly authorized representative.

(i) Locking Device. Any other door locking device, other than the one outlined above in (g) and (h), must be approved by the Commissioner or his duly authorized representative.

(j) Tag. To each pole must be attached immediately below the handhole, by mechanical means and not by adhesive, a stainless steel tag with a stamped or embossed legend which must include the pole outside diameter at the base, the overall length, and the gauge; i.e., 12.5" X 34'-6" X 3 gauge.

(k) Structural Requirements. The mast shall be manufactured in accordance with AASTHO's 1994 version of the "Standard Specifications for Structural Supports for Highway Signs, Luminaires and Traffic Signals". The shaft and base assembly must be designed to meet AASTHO's 1994 criteria for 80 MPH wind loading with a 30% gust factor. The poles shall be designed appropriately for Chicago applications for both street lighting and traffic signal applications, including signal mast arms.

TOP

5. (a) Design. The mast top shall be essentially conical with a globe-shaped upper-end and having a minimum wall thickness throughout of not less than 1/4 inch. The cone portion must meet the skirted portion of the top in a smooth filet, the skirt must enclose the top 7/8" inches of the mast. Three stainless steel, or other similar approved material, set screws not less than 3/4

inches long must be equally spaced in tapped holes around the skirt and must hold the top securely in place atop the mast. The design of the top shall be similar to one shown on Standard Electrical Drawing I 1420A.

(b) Material. The top must be aluminum alloy 356-F per ASTM B108. It shall have smooth surfaces, neat edges and corners and be free from lins, holes or other casting flaws. Non-metallic lops may be substituted if approved by the Commissioner.

(c) Finish. Tops shall be painted as herein specified.

(b)

Infrastructure Stabilization Items Scopes of Work and Specifications

HARDWARE

6. All the hardware necessary to complete the assembly of the pole shall be furnished.. All hardware will be as specified elsewhere in these specifications. Hardware not specified elsewhere must be stainless steel meeting the requirements of ASTM A193, or equal corrosion-resistant non-seizing metal, or a non-metallic material subject to approval by the Commissioner.

WELDING

7. (a) General. Every welded joint shall be made in conformity with the proper interpretation of the standard welding symbols of the American Welding Society as indicated on the drawings; however, each bidder must submit with his proposal a drawing showing the sizes and types of welds, must state the type of electrode, and must describe the welding methods, he proposes to use in fabricating the pole.

(b) Testing. Welds shall be inspected for penetration and soundness of the welds by the magnetic particle inspection method or by radiography. Acceptance or rejection will be governed by the same conditions as in Section 9. If the magnetic inspection process is to be used, the dry method with the direct current must be employed. All transverse welds must be magnetized by the "prod" (Circular magnetization) method. Longitudinal welds may be magnetized by either circular or longitudinal magnetization.

PAINTING

8. (a) Oil and Grease Removal. All metal surfaces shall be washed with an alkaline detergent to remove any oils or grease.

(b) Metal Cleaning. All exterior metal surfaces shall be cleaned by blasting with a combination of shot and grit to remove all dirt, mill scale, rust, corrosion, oxides and foreign matter and provide a "near white" surface in accordance with SSPC-SP10. Included in this process will be the interior base section of the mast to a minimum height of twelve (12) inches.

(c) Chemical Pretreatment. The cleaned metal surfaces shall then be treated with a hot, pressurized iron phosphate wash and shall be dried by convection heat.

(d) Primer Coat. All exterior surfaces are to be coated with a corrosion-inhibiting zinc-rich aromatic urethane to a minimum dry film thickness of 2.5 mils (.0025"). The aromatic urethane is to consist of a zinc dust content not less than 83% by weight in dried film. The coating

(b) *Infrastructure Stabilization Items Scopes of Work and Specifications*

shall be airless-spray applied and moisture cured.

(e) Finish Coat. All exterior surfaces are to be subsequently coated with an acrylic polyurethane to a minimum dry film thickness of 3.0 mils (.003^v). The coating shall be airless-spray applied and cured in a gas-fired convection oven by heating the steel substrate to between 150° Fahrenheit and 220° Fahrenheit.

(f) Interior Coat. Interior surfaces are to be coated with red oxide rust inhibitive alkyd primer to a dry film thickness of 1.5 mils.

(g) Durability. Both the exterior and interior coats must be capable of passing 1,000 hours of salt spray exposure as per ASTM BI 17 in a 5% NaCl (by weight) solution at 95°F and 95% relative humidity without blistering. Before test, the panel must be scribed with an "X" down to bare metal.

(h) Coating Measurement. Measurement of coating thickness must be done in accordance with SSPC-Pa 2 -73T, "Measurement of Dry Paint Thickness with Magnetic Gauges," except that the lowest "single spot measurement" in an area of two square inches must be not less than 5.5 mils.

(i) Color. Color must be gloss black unless otherwise noted in the order. A color sample must be submitted for approval prior to fabrication.

(j) Alternate Methods. Alternate painting methods may be reviewed and tested on a case by case basis. However, no coating method will be accepted unless the Commissioner judges such alternate to be equal to the coating herein specified.

MAST TEST

9. (a) General. All completed masts shall be available for testing for maximum deflection and set. The masts shall meet the structural requirements of Section 4(k). Unless specifically authorized in writing, all tests shall be made at the works of the manufacturer. A record of every test must be made and a certified copy of the test record must be submitted to the Commissioner before the masts are shipped.

(b) Lot. Tests for welds, deflection and set of the mast and of the mast arm supports shall be made upon three (3) masts of the first fifty (50) in every order. An additional one (1) mast shall be tested for each additional fifty (50) masts in the order. The selection of masts for testing shall be random from the entire completed lot. If any of the masts in any lot fail to meet the test, an additional three (3) masts of the same lot must be tested. If any of these masts fail to meet the test requirements, the entire lot will

be subject to rejection, except that the manufacturer may subject each mast in the lot to the test, and those which fulfill the requirement will be accepted. After testing, each base weld must be inspected by the magnetic particle method to determine that the welds have not been affected.

(c) Mast Requirements. With base rigidly anchored, a test load as indicated in Table A must be applied at a point approximately two feet (2'0") from the free end. The load must be applied at right angles to the center line of the mast and in the same vertical plane. The deflection must not be greater than that

indicated in Table A. Within one (1) minute after the test load is released, measurement must be made of the set taken by the mast. This set must not be greater than that indicated in Table A. The deflection measurement device must be reset to zero and the test load must be reapplied. The deflection must not change from the deflection noted in the first test by more than $\pm 5\%$. No measurable set must be noted within one (1) minute after test load is released.

(d) Mast Arm Support (simplex) Requirements. With an appropriate mast arm firmly attached to the mast, a test load of 300 pounds must be applied to the mast arm as a side pull at a point seven (7) feet from the mast. After the test, the mast arm support welds on the mast must be tested by the magnetic particle method to determine that they have not been affected.

PACKAGING

10. (a) General. The poles must be shipped in twelve (12) pole bundles. Each pole must be individually wrapped so that the pole can be bundled for shipping and unbundled for delivery to the City without damaging the pole or its finish.
- (b) Bundles. The bundles shall consist of twelve (12) poles laid base to top to form an approximately rectangular cylinder. Materials such as lumber (2" x 4" min.), non-marring banding, and other appropriate bundling materials must be used to make a rigid, long lasting, bundle capable of being handled, shipped and stored without shifting of contents or breaking, subject to approval. Any bundles, in which either poles or packaging is received broken, damaged or with contents shifted, will not be accepted and it will be the responsibility of the supplier to return the bundle to its original destination at no cost to the City of Chicago. The bundles should be capable of being stacked two (2) high without breaking, or shifting of the contents. Each bundle must be capable of being lifted by a fork lift truck or crane and the bundles must be shipped on a flatbed truck to facilitate unloading. Each pole wrapping must be clearly labeled indicating the pole size, \.e~34'6" 7 GAUGE. STEEL POLE, 15" B.C.

Infrastructure Stabilization Items Scopes of Work and Specifications

(c) Hardware. The bolt covers and their attachment devices must be shipped with each bundle and packaged in twelve (12) sets of four (4) each. The package must be labeled and placed in a prominent position to facilitate accessibility, and must be attached to, or within, the bundle in such a manner as to assure safe delivery. Payment will be withheld for any bundle delivered without the accompanying hardware. Pole caps must be attached at the manufacturer's facilities, or be packed separately in a manner similar to the bolt covers, and the same payment conditions will prevail. Cracked, broken or chipped parts will be considered as an incomplete delivery as regards payment.

Infrastructure Stabilization Items Scopes of Work and Specifications

TABLE A

POLE	GAUGE	BOLT CIRCLE	ANCHOR ROD	BASE P L A T E	TEST L O A D	M A X. D E X. F	M A X. S E W I N T	D R A G
7.67"x12.5" x34'6"	3	16.5"	1.5"	1.75"	3200#	22"	2.5"	827
6.17"x11" x34'6"	3	17.25"	1.25"	1.5"	2500#	26"	2.5"	824
5.17"x10.0" x34'6"	3	15.0"	1.25"	1.5"	2000#	30"	2.5"	808
5.17"x10.0" x34'6"	7	15.0"	1.25"	1.5"	1500//	30"	2.5"	808
3.95"x8.5" x32'6"	3	11.5"	1.25"	1.5"	1500#	33"	2.5"	763
3.95"x8.5" x32'6"	7	11.5"	1.0"	1.25"	1200#	33"	2.5"	762
3.87"x8.0" x29'6"	3	10.0"	1.0"	1.5"	1500//	28"	1.0"	657
3.87"x8.0" x29'6"	7	10.0"	1.0"	1.25"	1200#	28"	1.0"	656
4.15"x8.0" x	3	10.0"	1.0"	1.5"	1500#	23"	1.0"	655

27'6"								
4.15"x8.0"x	7	10.0"	.1.0"	1.25	1200#	23"	1.0"	654
27'6"								
4.20"x7.0"x	3	10.0"	1.0"	1.0"	1500#	13"	1.0"	653
20'0"								
3.70"x6.5"x	1 1	10.0"	1.0"	1.0"	800#	14"	1.0"	652
20'0"								

Infrastructure Stabilization Items Scopes of Work and Specifications

**SPECIFICATION 1450 DIVISION OF ELECTRICAL OPERATIONS
DEPARTMENT OF TRANSPORTATION CITY OF CHICAGO REVISED
APRIL 20, 2007**

MAST ARMS: 4-, 8-, 12-, AND 15-FOOT: STEEL

SUBJECT

1. This specification covers the requirements for 4-, 8-, 12-, and 15-foot steel mast arms for supporting street light luminaires.

GENERAL

2. (a) Specifications. The mast arms shall conform in detail to the requirements herein stated and to the Specifications and Methods of Test of the American Society for Testing and Materials cited by ASTM Designation Number of which the most recently published revision will govern.
- (b) Acceptance. Mast arms not conforming to this specification will not be accepted.
- (c) Drawings. The drawings mentioned herein are drawings of the Department of Transportation. They are integral parts of this specification cooperating to state necessary requirements.
- (d) Bidders Drawings. Bidders shall submit with their bids detailed scale drawings of the mast arms and attachments showing actual dimensions, details, and welds. Shop drawings must be original engineering drawings created by the manufacturer. The drawings must give every dimension necessary to show how the parts will fit each other and be properly held in assembly. These drawings shall be submitted in electronic format, preferably Microstation 95, if so requested by the City.
- (e) Sample. One complete mast arm of each size and of the manufacture intended to be furnished must be submitted within fifteen (15) business days upon request of the Chief Procurement Officer.
- (f) Warranty. The manufacturer shall warrant the performance and construction of the mast arms to meet the requirements of this

Infrastructure Stabilization Items Scopes of Work and Specifications

specification and must warrant all parts, components, and appurtenances against defects due to design, workmanship, or material developing within a period of three years after the mast arms have been delivered. This will be interpreted particularly to mean structural or mechanical failure of any element or weld, or failure of any portion of the painting system. The warranty must be furnished in writing guaranteeing material replacement including shipment, free of charge to the City. The Commissioner will be the sole judge in determining which replacements are to be made and the Commissioner's decision will be final.

DESIGN

3. (a) 4-Foot Mast Arm. Each 4-foot mast arm must be fabricated from a continuous, single piece, two (2) inch "extra strong" steel pipe conforming to the requirements of ASTM A53, Table X2. It must conform in detail with the mast arm shown on Drawing Number 661.
- (b) 8-Foot Mast Arm. Each 8-foot mast arm must be fabricated from a continuous, single piece, two (2) inch "extra strong" steel pipe conforming to the requirements of ASTM A53, Table X2. It must conform in detail with the mast arm shown on Drawing Number 620.
- (c) 12-Foot Mast Arm. Each 12-foot mast arm must be fabricated from two (2) continuous, single piece, two (2) inch "standard" steel pipes conforming to the requirements of ASTM A53, Table X2. It must conform in detail with the mast arm shown on Drawing Number 839.
- (d) 15-Foot Mast Arm. Each 15-foot mast arm must be fabricated from two (2) continuous, single piece, two (2) inch "standard" steel pipes conforming to the requirements of ASTM A53, Table X2. It must conform in detail with the mast arm shown on Drawing Number 840.
- (e) Mast Arm Attachment. The mast arm attachment to be welded to all mast arms will be a steel forging per ASTM A668, Class D, or cast steel conforming to the requirements for Grade 65-35 cast steel of ASTM A27, or can be fabricated from corrosion resistant steel plate such as "Cor-Ten" or approved equal. It shall be so designed that it may be fitted over the mast arm supports on the pole and be held by the mast arm supports in proper position without other support. The attachment must conform to the details shown on Standard Drawing 724. Provision must be made for fastening the attachment to each mast arm support by two special screws and washers as noted in Section 6.
- (f) Entry way for Wires. A drilled opening lined with a neoprene grommet having inserted therein a neoprene plug must be provided on the underside of the upper member of all arms approximately three inches from the point

Infrastructure Stabilization Items Scopes of Work and Specifications

of attachment. The clear opening must not be less than 5/8 inch in diameter. Its design must be submitted for approval by the Commissioner or his authorized representative.

- (g) Mast Arm Members. All mast arm members shall conform with the type of steel required for the arm specified. The members must be continuous lengths of pipe cut to the proper size to fabricate the mast arm lengths requested. No butt welded, swaged and welded or other pieced together configurations of

pipe lengths will be accepted. The outer and inner surfaces of the pipes shall be smooth and even without protrusions, nicks, holes or other imperfections.

PAINTING

4. (a) Oil and Grease Removal. All metal surfaces shall be washed with an alkaline detergent to remove any oils or grease.
- (b) Metal Cleaning. All exterior metal surfaces shall be cleaned by blasting with a combination of shot and grit to remove all dirt, mill scale, rust, corrosion, oxides and foreign matter and provide a "near white" surface in accordance with SSPCS-SP10. Included in this process shall be one to two inches of the interior section of the mast arm.
- (c) Chemical Pretreatment. The cleaned metal surfaces shall be treated with a hot, pressurized iron phosphate wash and shall be dried by convection heat.
- (d) Exterior Coat. A Thermosetting, polyester powder coat must be applied electrostatically to all cleaned and treated surfaces to a uniform eight (8) mil thickness in a one coat application. This powder coat must be cured in a convection oven at a minimum temperature of 400°F to form a high molecular weight fusion bonded finish.
- (e) Alternate Methods. Alternate powder coat methods may be reviewed and tested on a case by case basis. However, no coating method will be accepted unless the Commissioner judges such alternate to be equal to the coating herein specified.
- (I) Interior Coat. The interior metal surfaces must be powder coated with a thermoplastic hydrocarbon resin containing corrosion inhibitors. The resin shall be formulated for application over untreated metal surfaces. The resin must be applied at a temperature of approximately 200°F to a minimum thickness of three (3) mils. The interior thermoplastic coat must overlap the interior, thermosetting base coat by approximately one (I) inch. Alternate interior coatings may be used subject to prior approval of the Commissioner.

Infrastructure Stabilization Items Scopes of Work and Specifications

- (g) Durability. Both the exterior and interior coats must be capable of passing 1,000 hours of salt spray exposure as per ASTM BI 17 in a five percent (5%) NaCl solution at 95°F and 95% relative humidity without blistering.
- (h) Coating Measurement. Measurement of coating thickness must be done in accordance with SSPC-PA 2-73T, "Measurement of Dry Paint Thickness with Magnetic Gauges," except that the lowest "Single spot measurement" in an area of two square inches must be not less than 7.0 mils.
- (i) Color. Color must be gloss black, unless otherwise specified in the order. A color chip sample must be submitted for approval prior to fabrication.

WELDING

(a) Standards. Every weld shall be made in conformity with the proper interpretation of the standard welding symbols of the American Welding Society as indicated on the drawings; however, each bidder must submit with his proposal a drawing showing the sizes and types of welds, must state the type of electrode, and must describe the welding methods he

proposes to employ in fabricating the mast arm.

Testing. The welds shall be inspected for penetration and soundness by the magnetic particle inspection method or by radiography. If the magnetic inspection process is used, the dry method with direct current must be employed.

SCREWS

6. Two (2) special 1/2" - 13 NC x 1-1/2" long stainless steel cap screws, and two (2) stainless steel flat washers, must be provided for each mast arm attachment.

MAST ARM TESTS

7. (a) General. Tests must be made upon three (3) of the first fifty (50) arms in any order. An additional one (1) arm must be tested for each additional fifty (50) arms in the order.

(b) 4-Foot Mast Arm. The 4-foot mast arm, when securely attached to a suitable and proper supporting structure, must withstand a side pull of not less than three hundred (300) pounds applied at a point three feet six inches (3'-6") from the connection to the supporting structure without failure of welds.

(c) 8-Foot Mast Arms. The 8-foot mast arm, when securely attached to a

Infrastructure Stabilization Items Scopes of Work and Specifications

suitable and proper supporting structure, must withstand a side pull of not less than three hundred (300) pounds applied at a point seven (7) feet from the connection to the supporting structure without failure of the welds.

(d) 12-Foot and 15-Foot Mast Arms. The 12-foot mast arm and the 15-foot mast arm, when securely attached to a suitable and proper supporting structure, must withstand a side pull of 300 pounds applied at a point seven (7) feet from the connection to the supporting structure without failure of the welds.

(e) Rejection. If any of the mast arms in any lot fail to meet the test, an additional three (3) arms in the same lot must be tested. If any of these mast arms fail to meet the test requirements the entire lot will be subject to rejection, except that the manufacturer may subject each mast arm in the lot to the test, and those which meet the requirements will be accepted.

(f) All test results must be certified by the manufacturer. Documentation must be available for the City to approve.

PACKAGING

8. (a) General. The arms shall be shipped in bundles. Each arm must be individually wrapped so that the arm can be bundled for shipping and unbundled for delivery without damage to the arm or its finish. Materials such as lumber (2"x4" min.), non-marring banding, and other appropriate bundling materials must be used to make a rigid, long lasting, bundle capable of being handled, shipped and stored without shifting or breaking of the contents. Any bundles, in which either the mast arms or packaging is received broken, damaged or with contents shifted, will not be accepted and it will be the responsibility of the supplier to return the bundle at no cost to the City. Each bundle must be

capable of being lifted by a fork lift truck or crane and the bundles must be shipped in a flatbed truck to facilitate unloading. Each arm wrapping must be clearly labeled indicating the arm size, i.e. 8' STEEL LUMINAIRE MAST ARM.

- (b) The hardware must be shipped with each bundle. The package must be labeled and placed in a prominent position to facilitate accessibility, and must be attached to, or within, the bundle in such a manner as to assure safe delivery.
- (c) All mast arms will be delivered to the Division of Electrical Operations storage yard at 4101 South Cicero Avenue in Chicago, or to another location within the City as indicated on the order.

THIS SPECIFICATION SHALL NOT BE ALTERED

Infrastructure Stabilization Items Scopes of Work and Specifications

**2. ELECTRICAL SPECIFICATION 1452 DIVISION OF ENGINEERING
DEPARTMENT OF TRANSPORTATION CITY OF CHICAGO REVISED
MARCH 19, 2014**

POLE: ANCHOR BASE, ALUMINUM, TAPERED TUBULAR SHAFT

SUBJECT

- 1. This specification states the requirements for tapered, tubular, aluminum anchor base poles. They will support street light luminaires mounted on either truss type arms or davit style arms. The poles will be served by underground cables.

GENERAL

- 2. (a) Specifications. The poles shall conform in detail to the requirements herein stated, and to the requirements of the following organizations as cited herein:

Aluminum Association (AA) American Association of State Highway and Transportation Officials (AASTHO)
American National Standards Institute (ANSI) American Society for Testing and Materials (ASTM) American Welding Society (AWS) Society for Protective Coatings (SSPC)

(b) Acceptance. Poles not conforming to this specification will not be accepted. The Commissioner will be the sole judge in determining if the poles meet this specification.

(c) Bidders Drawings. Bidders must submit with their bids detailed scale drawings of the mast showing actual dimensions, details, and welds. Shop drawings must be original engineering drawings created by the manufacturer. The drawings must show every dimension necessary to show how all parts

will fit each other and be properly held in assembly.

(d) Standard Drawings. The drawings mentioned herein are drawings of the Department of Transportation being an integral part of this specification cooperating to state necessary requirements.

332

Infrastructure Stabilization Items Scopes of Work and Specifications

- (e) Sample. If requested by the Chief Procurement Officer, one completely assembled anchor-base pole of the manufacture intended to be furnished, must be submitted for review by the Commissioner within fifteen (15) business days after receipt of notice.
- (f) Warranty. The manufacturer shall warrant the performance and construction of the light poles to meet the requirements of this specification and shall warrant all parts, components, and appurtenances against defects due to design, workmanship, or material developing within a period of five years after the light poles have been delivered. This will be interpreted particularly to mean structural or mechanical failure of any element or weld, or any faults in the anodized surfaces. The warranty must be furnished in writing guaranteeing material replacement including shipment, free of charge to the City. The Commissioner will be the sole judge in determining which replacements are to be made. The Commissioner's decision will be final.

STANDARDS

- 3. (a) Assembly. Each anchor base pole shall consist of an aluminum mast with handhole entry, aluminum hinged entry door, grounding nut, mast base plate, top cap for non-davit masts, bolt covers, and all necessary hardware required for complete assembly of these parts, ready for assembly, without special tools.
 - (b) Interchangeability. Members of each pole type must be mutually interchangeable for assembly, so that no reworking will be required to make any member fit properly in the place of any other similar member of any other similar pole.
 - (c) Design. Each pole type must conform in design and dimensions to the pertinent drawing(s) listed in Table A.

MASTS

- 4. (a) Mast Size. The outside diameters of the mast of each pole type shall be as listed in Table A. The mast taper will be approximately 0.14 inches per foot.
 - (b) Material. The shaft must be fabricated from one length of 6063-14 wrought aluminum alloy meeting the requirements of ASTM B221. After all, welding operations are completed, the mast must be brought to a 16 temper having minimum physical characteristics of ASTM B221. The wall thickness of the shaft and the diameter of the shaft shall be as listed in table A and as shown on the appropriate standard drawing. Material certification shall be provided from the tube manufacturer.

Infrastructure Stabilization Items Scopes of Work and Specifications

- (c) Fabrication. The mast must be fabricated with no longitudinal or lateral welds in the tube. The

completed masts must have smooth external surfaces free from protuberances, dents, cracks or other imperfections marring their "appearance. Each mast must be straight and centered on its longitudinal axis.

(d) Base. The mast base must be a permanent mold aluminum casting conforming to the requirements for aluminum alloy 356-T6 of ASTM B-108 or ASTM B-26. The base shall be similar in shape and dimensions to that shown on the appropriate standard drawing for the specific mast. The base shall consist of a collar, flange, and any other members necessary to provide strength and reduce the concentration of anticipated stresses. The shaft must extend into the base as shown on the appropriate standard drawing and be circumferentially welded to the base casting at the top outer surface and the lower inner surface of the base. Bases must be attached to the mast so that the bearing surface of the base is at right angles to the longitudinal axis of the mast.

Non-metallic removable bolt covers which completely cover the anchor bolts and nuts must be provided. The covers must be attached with stainless steel screws or another type of non-seizing fastener, as approved by the Commissioner. The covers must enclose the anchor bolts and be secured in an approved manner.

All anchor rod openings for each pole type must have a width as listed in Table A. Each opening must be sized to have a circumferential slot length equal to 15° of the circumference.

(e) Cable Entry for Conventional Poles. An opening of approximately one and one quarter inches (1-1/4") in diameter, rimmed with a rubber or nylon grommet, must be furnished and installed at the point on the shaft where the clamp on the upper member of the mast arm bracket meets the pole. Certain masts may require two cable entries, depending on the order. There will be no extra compensation for the extra cable entry. This cable entry requirement does not apply to pole masts designed for davit style arms. This requirement does apply to conventional poles (Standard Electrical Drawings 890 and 938).

(l) Option: Side Mount for Luminaire. If requested, the pole mast will be prepared for the mounting of a sidewalk-side luminaire. An opening of approximately one and one-quarter inches (1-1/4") in diameter, rimmed with a rubber or nylon grommet, must be furnished and installed at the proper height, as indicated on the appropriate standard drawing, or as directed in the order. In addition, two (2) holes must be drilled to accept two (2) rivnuts for mounting a City back plate for a mid-mount luminaire.

Infrastructure Stabilization Items Scopes of Work and Specifications

All three (3) holes must be properly spaced and aligned to accept the City standard back plate for the appropriate mid-mount luminaire. The rivnuts (3/8-16) must be inserted in the pole. The holes must be properly aligned with the handhole as indicated on the standard drawings.

(g) Top of Shaft for Davit Arm. The top one foot of the mast shall be formed as shown on the appropriate standard drawing. An adapter ring may be provided if required. Two sets of holes 9/16 inches in diameter must be drilled through the mast to accommodate two bolts to attach a davit arm. The lower set (two holes) must be in line with the mast arm. The other set must be 90° apart from the other. These requirements apply to pole masts designed for davit style arms.

(h) Provision for Ground. A tapped hole must be provided on an extension or offset, centered on the handhole door frame's interior vertical surface, to accept a 1/2"-13 bolt for a ground connection.

(i) Entry. A vertical doorframe for reinforcing a door opening which

r provides access to the interior of the mast must be welded on the inside of the pole and be centered approximately 18 inches above the bottom of the base. The doorframe must be formed and welded of aluminum alloy 6063-T6 with a cross-section to adequately reinforce the opening of the mast. The doorframe must be as indicated on the appropriate standard drawing. The actual door opening must be sized to perfectly match the door size. For all arterial poles and for all conventional poles, the vertical centerline of the entry must be at a right angle clockwise to the vertical centerline of the mast arm. For the residential davit poles, the vertical centerline of the entry must be in-line with the vertical centerline of the mast arm. An internal flange must be welded to the inside of the pole at the bottom of the door opening. This flange will be drilled to accept a bolt. The bolt will be used to attach a hinged door to the pole. An aluminum tab must be welded to the inside upper portion of the door opening. A hole must be drilled into the tab that will accept a 1/4-inch screw. The hole must be centered horizontally in the door opening and must be centered 3/8 of an inch down from the uppermost portion of the door opening. A steel spring clip must be mounted to the tab. The clip must be made to accept a 1/4"-20 machine screw.

(j) Door. The removable door must be formed of the same aluminum as the pole. The door must fit the pole opening within a tolerance of 1/8 of an inch. The door must be flush with the pole surface in the closed position and appear as part of the original mast. The door must be attached to an internal hinge which will allow the door to open out and down. The hinge must be bolted to a flange on the inside of the pole at the bottom of the door opening, so that the door and hinge may be un-bolted and replaced if need be. The door opening must be sized according to the

Infrastructure Stabilization Items Scopes of Work and Specifications

appropriate standard drawing. A hole must be drilled in the top of the door in alignment with the hole on the mast. A 1/4"-20 Allen head button machine screw must be provided to fasten the door to the doorframe. The screw must have a stainless steel core with a nylon threaded body. Other types of non-seizing fasteners may be considered. All doors of the same size must be interchangeable. The door and attachment method will be subject to approval by the Commissioner or his duly authorized representative.

(k) Tag. To each pole must be attached immediately below the handhole, by mechanical means and not by adhesive, a stainless steel tag with a stamped or embossed legend which must include the pole outside diameter at the base, the overall length, and the wall thickness.

(1) Structural Requirements. The mast shall be manufactured in accordance with AASTHO's 1994 version of the "Standard Specifications for Structural Supports for Highway Signs, Luminaires and Traffic Signals". The shaft and base assembly must be designed to meet AASTHO's 1994 criteria for 80 MPH wind loading with a 30% gust factor. The poles shall be designed appropriately for Chicago street lighting applications, including mast arm and luminaires. Thirty - foot davit poles and thirty-foot conventional poles for arterial streets must also allow for banner and flower basket attachments. The pole manufacturer must provide load calculations that verify that the poles are designed properly.

TOP CAP FOR NON-DAVIT POLES

5. The top cap shall be aluminum alloy. It must have smooth surfaces, neat edges and corners and be free from fins, holes, or other casting flaws. Three stainless steel set screws not less than 3/8 inches long must be equally spaced in tapped holes around the skirt to securely hold the top in place.

VIBRATION DAMPER

6. Each pole shall be equipped with a vibration damper at the base of the mast arm.

6. Each pole shaft will have an internal vibration damper, if requested, located at a position as shown on the appropriate standard drawing. The vibration damper must be welded or bolted to the inside of the pole shaft. If the standard drawing does not show a vibration damper none should be provided. The design of the vibration damper is subject to approval by the Commissioner or his representative.

HARDWARE

7. All the hardware necessary to complete the assembly of the pole must be furnished. All hardware will be as specified elsewhere in these

7. *Infrastructure Stabilization Items Scopes of Work and Specifications*

specifications. Hardware not specified elsewhere must be stainless steel, or equal corrosion-resistant non-seizing metal, or a non-metallic material subject to approval by the Commissioner.

WELDING

8. (a) General. Every welded joint shall be made in conformity with the proper interpretation of the standard welding symbols of the American Welding Society as indicated on the drawings. Each bidder must submit with his proposal a drawing showing the sizes and types of welds, must state the type of electrode, and must describe the welding methods, he proposes to use in fabricating the pole.

(b) Testing. All welds of five percent (5%) of the poles in every lot must be inspected for penetration and soundness of the welds by radiography, or by a penetrant method. Acceptance or rejection will be governed by the same conditions as in the TESTING Section.

(c) Certifications. Welders must have proper certification for the welding operations required. Welding by non-certified personnel will not be allowed. Certifications must be available upon request.

FINISH

9. (a) General. All completed masts shall have a brushed satin natural finish or an anodized finish, as required by the project or in the purchase order.

(b) A satin aluminum finish requires that each mast be rotary sand finished. The satin finish shall be accomplished by using 40-50 grit belts to remove taper marks and scratches. A minimum of one pass with a 120 grit belt over the entire shaft is required to provide a uniform appearance.

(c) An anodized finish will be either matte black or semi-gloss black. A color sample must be submitted for approval before any factory production. The anodizing process must include cleaning, etching, anodizing, and sealing the mast. The etching process must meet the requirements of AA-C22. The anodizing process must meet the requirements of AA-A42. The contractor must submit his anodizing process for approval before any factory production.

MAST TEST

10. (a) General. All completed masts shall be available for testing for maximum deflection and set. The masts must meet the structural requirements of Section 4(1). Unless specifically authorized in writing, all tests must be made by the manufacturer. A record of every test must be

10. *Infrastructure Stabilization Items Scopes of Work and Specifications*

made and a certified copy of the test record must be submitted to the Electrical Section of the Division of Engineering before the masts are shipped. .

(b) Lot. Tests for deflection of the mast must be made upon five (5%) percent of all the masts in every lot (two (2) min.). The selection of masts for testing must be random from the entire completed lot. If any of the masts in any lot fail to meet the test, an additional three (3%) percent of the masts of the same lot must be tested (two (2) min.). If any of these masts fail to meet the test requirements, the entire lot will be subject to rejection, except that the manufacturer may subject each mast in the lot to the test, and those which fulfill the requirement will be accepted. After testing, each base weld must be inspected by radiography or the penetrant method to determine that the welds have not been affected. After testing, no permanent set should be visible or apparent. The mast should appear straight.

(c) Mast Requirements. With base rigidly anchored, a test load of 500 pounds must be applied at a point approximately eighteen inches (18") from the free end. The load must be applied at right angles to the center line of the mast and in the same vertical plane. With no failure of any component part, the deflection must not be greater than 7.5% of the pole height. After removal of the load, the deflection measurement device must be reset to zero and the test load must be reapplied. The deflection must not change from the deflection noted in the first test by more than $\pm 5\%$.

PACKAGING

II. (a) General. The poles must be shipped in bundles. Each pole or bundle shall be wrapped so that the poles can be handled and stored without damage to the surfaces. Bundles. The poles in each bundle must be laid base to top to form an approximately rectangular cylinder. Materials such as lumber (2" x 4" min.), non-marring banding, and other appropriate bundling materials must be used to make a rigid, long lasting, bundle capable of being handled, shipped and stored without shifting of contents or breaking. Any bundles, in which either poles or packaging is received broken, damaged or with contents shifted, will not be accepted and it will be the responsibility of the supplier to return the bundle to its original destination at [no](#) cost to the City of Chicago. The bundles should be capable of being stacked two (2) high without breaking, or shifting of the contents. Each bundle must be capable of being lilted by a fork lift truck or crane and the bundles must be shipped on a flatbed truck to facilitate unloading.

(b) Hardware. The bolt covers and their attachment devices must be

(b) *Infrastructure Stabilization Items Scopes of Work and Specifications*

shipped with each bundle. The package must be labeled and placed in a prominent position to facilitate accessibility, and must be attached to, or within, the bundle in such a manner as to assure safe delivery. Payment will be withheld for any bundle delivered without the accompanying hardware. Pole caps must be attached at the manufacturer's facilities, or be packed separately in a manner similar to the bolt covers, and the same payment conditions will prevail. Cracked, broken or chipped parts will be considered as an incomplete delivery as regards payment.

Infrastructure Stabilization Items Scopes of Work and Specifications

TABLE A

POLE	THICK NESS	BOLT CIRCLE	ANCHOR ROD	BASE PLAT E	MAX. DEF L NG	DRA W I
7"x4.5"x12'-5"	.156"	10"	1.0"	0.75"	11"	940
7"x4.5"x20*-0"	.156"	10"	1.0"	0.75"	18"	890
8"x4.5"x27'	.312	11.5"	1.0"	0.75"	26"	975
10"x6"x24'-5"	.312"	15"	1.25"	1.25"	22"	941
10"x6"x27'- 10.5"	.312"	15"	1.25"	1.25"	25"	938
10"x6"x29'- 4.625"	.312"	15"	1.25"	1.25"	27"	971
10"x6"x34'- 4.625"	.312"	15"	1.25"	1.25"	31"	972

4.625"

Infrastructure Stabilization Items Scopes of Work and Specifications

**ELECTRICAL SPECIFICATION 1453 DI VISION OF ENGINEERING
DEPARTMENT OF TRANSPORTATION CITY OF CHICAGO
REVISED MARCH 14, 2013**

MAST ARMS: ALUMINUM, TRUSS TYPE AND DAVIT TYPE

SUBJECT

This specification covers the requirements for aluminum mast arms for supporting street light luminaires. The aluminum arms will be supported by aluminum light poles.

GENERAL

(a) Specifications. The mast arms shall conform in detail to the requirements herein stated and to the requirements of the following organizations as cited herein:

Aluminum Association (AA)

American Association of State Transportation and Highway Officials (AASTHO)

American National Standards Institute (ANSI) American Society for Testing and Materials (ASTM)

American Welding Society (AWS) Society for Protective Coatings (SSPC)

Acceptance. Mast arms not conforming to this specification will not be accepted. The Commissioner will be the sole judge in determining if the arms meet this specification.

Bidders Drawings. Bidders must submit with their bids detailed scale drawings of the mast arm and bracket attachment proposed to be welded to the mast arm as the means for attaching these mast arms to poles. For davit arms, drawings must show how the davit is attached to the top of the light pole and is secured. The drawings must give every dimension necessary to show how the parts will fit each other and be properly held in assembly.

(d)

Drawings. The drawings mentioned herein are drawings of the Department of Transportation being an integral part of this specification cooperating to state the necessary requirements.

Infrastructure Stabilization Items Scopes of Work and Specifications

(e) Sample. If requested by the Chief Procurement Officer, one complete mast arm of the manufacture intended to be furnished, must be submitted within fifteen (15) business days upon receipt of such request.

(f) Warranty. The manufacturer shall warrant the performance and construction of the mast arms to meet the requirements of this specification and shall warrant all parts, components, and appurtenances against defects due to design, workmanship, or materials, developing within a period of five years after the mast arms have been delivered. This will be interpreted particularly to mean structural or mechanical failure of any element or weld, or any faults in the anodized surfaces. The warranty must be furnished in writing guaranteeing material replacement including shipment, free of charge to the City. The Commissioner will be the sole judge in determining which replacements are to be made. The Commissioner's decision will be final.

(g) Structural Requirements. The arms shall be manufactured in accordance with AASTHO's 1994 version of the Standard Specifications for Structural Supports for Highway Signs, Luminaires and Traffic Signals. The arms must be designed to meet AASTHO's 1994 criteria for 80 MPH wind loading with a 30% gust factor. The arms shall be designed for Chicago street lighting applications. The arm manufacturer must provide structural calculations that verify that the arms are designed properly.

TRUSS ARM DESIGN

3. (a) Each mast arm must be a truss type fabricated of two (2) inch "standard" aluminum pipe or tube 6063-T4 alloy conforming to the requirements of ASTM B429, or ASTM B221, or other approved design. The arm must be heat treated to a T-6 temper after fabrication and welding.
- (b) Mast Arm Attachment. The mast must be attached to the pole by means of an extruded aluminum clamp with a bolting arrangement to hold the arm firmly in place. The extrusion must be aluminum alloy 6061-T6 conforming to the requirements of ASTM B221, B308, or an approved equal. The clamps shall be designed to securely fasten the mast arm to the pole so that the arm cannot be dislodged vertically or horizontally from its intended position on the pole by wind gusts, vibrations or other normally anticipated natural phenomena.
- (c) Dimensions. The truss type arm must have the dimensions indicated on Standard Electrical Drawing 943 or Standard Electrical Drawing 944 for the appropriate arm specified. Truss arms will be

Infrastructure Stabilization Items Scopes of Work and Specifications

available in nominal horizontal lengths of 4 foot, 6 foot, 8 foot, 12 foot, and 15 foot, with either 4.5 inch or 6 inch clamps. The distance between the lower and upper members, measured between the vertical centers of the upper and lower attachment plates, must be 1'-9". With the arm attached to the pole intended to be supplied, the vertical rise from the center of the top attachment plate to the horizontal centerline of the end of the arm must be no greater than 2'-8". The horizontal axis of the free end of the upper member, when attached to the pole, must not exceed 3° above the true horizontal without the luminaire weight, nor be less than 1/2° above the true horizontal with a 35 lb. weight supported at the free end of the arm.

(d) Mating of Members. The upper and lower members shall be mated in such a manner as to assure that they will not separate due to vibration, weather conditions such as high wind gusts, icing, etc., or any other normally anticipated stress condition.

(e) Interchangeability. Members of each truss arm size must be mutually interchangeable for assembly so that

- (e) interchangeability. members of each truss arm size must be mutually interchangeable for assembly, so that no reworking will be required to make any member fit properly in the place of any other similar member of any other similar arm.

DAVIT ARM DESIGN

- 4. (a) Each arm must be fabricated from either 4.5-inch diameter or 6.0-inch diameter aluminum tubing of 6063-T4 alloy. After all fabrication and welding, the arm must be heat treated to a T6 temper.
- (b) The arm must be attached to the mast by slipping the bottom of the arm tube over the top of the mast. The arm must have four (4) holes pre-drilled at its base to accommodate two (2) through bolts set 90° apart, as shown on the Standard Drawings. The bottom bolt will be in direct line with the length of the arm. The holes must match the holes in the mast so that after assembly the arm and mast appear as a single continuous unit. When bolted to the pole, the arm must not shift or become dislodged by wind gusts, vibrations, or other phenomena.
- (c) The davit arm must be dimensioned as indicated on Standard Electrical Drawing 945, 946, 948, 949, or 950, for the appropriate arm specified. Davit arms must be available in nominal horizontal lengths of 8 foot and 12 foot for the 4.5-inch pole tops. Davit arms must be available in nominal lengths of 8 foot, 12 foot, and 15 foot for 6-inch pole tops. Davit arms will be single or twin as specified. A 2 3/8-inch diameter tenon will be attached to the end of each arm. The horizontal axis of the tenon, when the arm is attached to the pole, must not exceed 3° above the true horizontal without the luminaire weight, nor be less than 1/2° above the true horizontal with a

(b) *Infrastructure Stabilization Items Scopes of Work and Specifications*

35 lb. weight supported by the tenon.

- (d) Interchangeability. All davit arms for a 4.5-inch pole top must be interchangeable with each other. The same is required of davit arms for a 6-inch pole top.

WELDING

- 5. (a) General. Every welded joint shall be made in conformity with the proper interpretation of the standard welding symbols of the American Welding Society as indicated on the drawings. Each bidder must submit with his proposal a drawing showing the sizes and types of welds, must state the type of electrode, and must describe the welding methods, he proposes to use in fabricating the arms.
- (b) Testing. All welds of five percent (5%) of the arms in every lot must be inspected for penetration and soundness of the welds by radiography or by penetrant inspection. Acceptance or rejection will be governed by the same conditions as in the TESTING Section.
- (c) Certifications. Welders must have proper certification for the welding operations required. Welding by non-certified personnel will not be allowed. Certifications must be made available upon request.

FINISH

- 6. (a) General. All completed arms shall have a brushed satin natural

finish or an anodized finish, as required by the project or in the purchase order.

(b) A satin aluminum finish requires that each arm be rotary sand finished. The satin finish shall be accomplished by using 40-50 grit belts to remove taper marks and scratches. A minimum of one pass with a 120 grit belt over the entire arm is required to provide a uniform appearance.

(c) An anodized finish will be either matte black or semi-gloss black. A color sample must be submitted for approval before any factory production. The anodizing process must include cleaning, etching, anodizing, and sealing the aluminum arm. The etching process must meet the requirements of AA-C22: The anodizing process must meet the requirements of AA-A42. The contractor must submit his anodizing process for approval before any factory production.

HARDWARE

7. All hardware furnished for attachment of mast arm to pole must be -

Infrastructure Stabilization Items Scopes of Work and Specifications 344

series 300 stainless steel. All hardware necessary to complete the assembly of the arm to the pole must be provided.

MAST ARM TESTS

8. (a) General. Five percent (5%) of the mast arms of each size in every order shall be tested for structural integrity.

(b) Tests. The mast arms, when securely attached to a suitable and proper supporting structure, must withstand a horizontal (sideward) pulling force as indicated in Table A, and a vertical (downward) load as indicated in Table A. These loads may be applied independently. Each load must be applied at the end of the arm without any apparent permanent set, or damage to the welds joining the arm and mast arm attachment. The appropriate loading for each arm is indicated in Table A. On twin arms each arm extension must be tested.

(c) Rejection. If the mast arms fail to meet the test, an additional three percent (3%) of the mast arms in the same lot must be tested. If any of these mast arms fail to meet the test requirements, the entire lot will be subject to rejection, except that the manufacturer may subject each mast arm in the lot to the test, and those which fulfill the requirements will be accepted.

(d) All mast arms must meet the structural requirements of Section 2(g). All tests shall be certified by the manufacturer. Test results should be submitted to the Electrical Section of the Division of Engineering, upon request.

PACKAGING

9. (a) General. The mast arms must be shipped in bundles. Each arm or bundle shall be wrapped so that the arms can be handled and stored without damage to the surfaces.

(b) Bundles. The bundles shall consist of fifty (50) to seventy-five (75) arms laid to form an approximately rectangular bundle. Materials such as lumber (2"x4"), stainless steel banding, and other appropriate bundling materials must be used to make a rigid, long-lasting bundle capable of being handled, shipped

bundling materials must be used to make a rigid, long lasting, bundle capable of being handled, shipped and stored without shifting of contents or breaking, subject to approval. Any bundles, in which either the arms or packaging, is received broken, damaged, or with contents shifted, will not be accepted, and it will be the responsibility of the supplier to return the bundle to its original destination at no cost to the City of Chicago. The bundles should be capable of being stacked two (2) high without breaking,

Infrastructure Stabilization Items Scopes of Work and Specifications

or shifting of the contents. Each bundle must be capable of being lifted by a fork lift truck or crane and the bundles must be shipped on a flatbed truck to facilitate unloading.

- (c) Hardware. The clamp backs and mounting hardware must be attached to the clamp fronts on the end of the arm, and must be shipped with each mast arm bundle. Mounting hardware for the davit arms must be packed and shipped with each davit arm bundle. Payment will be withheld for any bundle delivered without the accompanying hardware. Cracked, broken or chipped parts will be considered as an incomplete delivery as regards payment.

TABLE A

ALUMINUM ARM	HORIZONTAL LOAD	VERTICAL LOAD	DRAWING #
Truss 4.5"x4'	100#	250#	943
Truss 4.5"x6'	100#	250#	943
Truss 4.5"x8'	100#	250#	943
Truss 4.5"x 12'	100#	250#	943
Truss 4.5"x 15'	100#	250#	943
Davit 4.5"x 8'	100#	250#	945
Davit 4.5"x 12'	100#	200#	946
Davit 6.0"x 8'	100#	250#	948
Davit 6.0"x 12'	100#	250#	949
Davit 6.0"x 15'	100#	250#	950

Infrastructure Stabilization Items Scopes of Work and Specifications

CABLE: SINGLE-CONDUCTOR, COPPER 600 VOLT

SUBJECT

1. This specification states the requirements for single conductor cables intended to be used in 240 VAC street lighting circuits. The cable will also be used as service cable for both street light controllers and traffic signal controllers. The cables will be installed in underground conduit and rated as 600 volt.

GENERAL

2. (a) Specifications. The cable must conform in detail to the requirements herein stated, and to the applicable portions of the latest revisions of the specifications and methods of test of the following agencies:

- (1) ASTM - American Society for Testing and Materials
- (2) ICEA - Insulated Cable Engineers Association
- (3) IEEE - Institute of Electrical and Electronics Engineers
- (4) UL - Underwriters Laboratories

(b) Acceptance. Cable not in accordance with this specification will not be accepted.

(c) Sample. If requested by the Chief Procurement Officer, a three (3) foot sample of the cable intended to be provided under this specification must be sent to the attention of the Engineer of Electricity within fifteen (15) days of receipt of such request.

(d) Warranty. The manufacturer must warrant the cable to be first class material throughout. In lieu of other claims against them, if the cables are installed within twelve (12) months of date of shipment, the manufacturer must replace any cable failing during normal and proper use within two years of date of installation. All replacements under this warranty must be made free of charge F.O.B. delivery point of the original contract.

CABLES

3. (a) Construction. The cable must consist of an uncoated multiple strand copper conductor with a tight fitting thermoset, free stripping, concentric layer of ethylene propylene (EPR) insulation.

(b) The number of strands and the outer diameter of the cable shall be as noted in TABLE A.

(c) Cable shall be UL approved for sunlight resistance and for direct burial applications.

(d) Cable must meet IEEE 383 and UL 1581 70 000 BTUs per hour flame test requirements.

- (a) Cable must meet IEEE 383 and UL 1581 70,000 BTUS per hour flame test requirements.

COLOR CODE

- 4. (a) Triplexed cable shall consist of a black cable, a red cable, and a green ground cable. Triplexed cable will have a 16" to 1 8" lay.
- (b) Individual cables will be black, red, or white, depending upon the order.

CONDUCTOR

- 5. (a) Material. The conductors must be soft round copper strands.
- (b) Specifications. The conductor must meet the requirements of ASTM B3 and ASTM B8.
- (c) Sizes. The conductor sizes must be in accordance with all requirements in Table A of this specification.
- (d) Stranding. The number of strands must be as indicted in Table A. Stranding must meet the requirements of ASTM B8, Class B.

INSULATION

- 6. (a) Type. The insulation must be ethylene propylene rubber compound (EPR) meeting the requirements of ICEA S-95-658 and UL 44 for RHW-2 cable and UL 854 for USE-2 cable.
- (b) Thickness. The insulation must be circular in cross-section, concentric to the conductor, and must have an average thickness not less than that set forth in Table A of this specification, and a spot thickness not less than ninety percent (90%) of the average thickness.

Infrastructure Stabilization Items Scopes of Work and Specifications

- (c) Cable Marking. The cable must be identified by a permanently inscribed legend in white lettering as follows:

1/C No. (conductor size) AWG-600V-90"C-EPR-RHW-2

The legend must be repeated at approximately eighteen (18) inch intervals on the outside surface of the cable parallel to the longitudinal axis of the conductor. A sequential footage marking must be located on the opposite side from the legend.

TESTING

- (a) Initial Physical Requirements.
 - 1. Tensile strength, minimum, p.s.i. 1200
 - 2. Elongation at rupture, minimum % 250
- (b) Over Exposure Test. After conditioning in an air oven at 121 ± 1°C for 168 hours using methods of test

- (b) Oven Exposure Test. After conditioning in an air oven at $121 \pm 1^\circ\text{C}$ for 168 hours using methods of test described in ASTM D 573:
 - 1. Tensile strength, minimum % of initial value 75
 - 2. Elongation at rupture, minimum percent of initial value 75
- (c) Water Absorption Test. Gravimetric method: After 168 hours in water at $70 \pm 1^\circ\text{C}$ water absorption, at a maximum - 5 milligrams per square inch
- (d) Cold Bend Test. The completed cable must pass the test requirements of ASTM D 470, except that the test temperature must be -25°C .
- (e) Electrical Tests.
 - 1. Voltage. The completed cable must meet an A.C. and D.C. voltage test in accordance with ASTM D 470 and D 2655.
 - 2. Insulation Resistance. The completed cable must have an insulation resistance constant of not less than 20,000 ohms when tested in accordance with ASTM D 470.
- (f) Flame Tests. Cable must pass a 70,000 BTU flame test in accordance with IEEE 383.
- (g) All of the above tests must be on cable produced for the order. Tests must be taken on samples taken every 25,000 feet, or fraction thereof, of each conductor size.

Infrastructure Stabilization Items Scopes of Work and Specifications

- (h) Test Reports. No cable shall be shipped until certified copies of all factory tests have been reviewed and approved by the City. Cable that does not pass any one of the above tests will be rejected.

PACKAGING

- 8. (a) Reels. The completed cable must be delivered on sound substantial, non-returnable reels. Both ends of each length of cable must be properly sealed against the entrance of moisture and other foreign matter by the use of clamp-on cable caps. The ends must be securely fastened so as not to become loose in transit. Before shipment, complete 2 X 4 lagging must be applied to all reels.
- (b) Footage. Each reel must contain the length of cable as set forth in Table A of this specification. Alternate lengths may be considered.
- (c) Reel Marking. A metal tag must be securely attached to each reel indicating the reel number, contract number, date of shipment, gross and tare weights, the appropriate City commodity code if applicable, and a description of the cable. Also, each reel must have permanent marking on it indicating the total footage, and the beginning and ending sequential footage numbers. Directions for unrolling the cable must be placed on the reel with an approved permanent marking material such as oil-based paint or a securely attached metal tag.
- (b)

Infrastructure Stabilization Items Scopes of Work and Specifications

TABLE A

CONDUCTOR INSULATION

	<u>THICKNESS AWG</u>	<u>STRANDS MILS</u>
14	7	45
12	7	45
10	7	45
8	7	60
6	7	60
4	7	60
2	7	60
1/0	19	80
2/0	19	80
3/0	19	80
4/0	19	80

<u>40</u>	<u>17</u>	<u>00</u>	
<u>VOLTS</u>	<u>FEET</u>	<u>INCH</u>	<u>LENGTH DIAMETER</u>
250 MCM A C TEST	37 95 REEL	OVERALL	
5500	2000	.133	
5500	2000	.152	
5500	2000	.176	
5500	2000	.236	
5500	2000	.274	
5500	2000	.322	
5500	1000	.382	
7000	1000	.470	
7000	1000	.514	
7000	1000	.564	
7000	1000	.620	
8000	1000	.705	

Infrastructure Stabilization Items Scopes of Work and Specifications

**ELECTRICAL SPECIFICATION 1601 DIVISION OF ENGINEERING
DEPARTMENT OF TRANSPORTATION CITY OF CHICAGO
OCTOBER 25, 2016**

SELF-SUPPORTING ALUMINUM STREET LIGHT CABLE

SCOPE

1. This specification describes preassembled, reverse twist, secondary cable consisting of one (1) bare steel reinforced aluminum conductor used as a messenger and neutral in combination with two (2) insulated, stranded, aluminum conductors. Cable will be used on aerial distribution circuits operated at a maximum voltage to ground of 600 volts.

GENERAL

- (a) Specifications. The cable shall conform in detail to the requirements herein stated and to the referenced specifications of the American Society for Testing and Materials (ASTM), the National Electric Code (NEC), Underwriters Laboratories (UL), the Insulated Cable Engineers Association (ICEA), and the National Electrical Manufacturers Association (NEMA), in which the most recently published revisions will govern.
- (b) Acceptance. Cable not conforming to this specification will not be accepted.
- (c) Sample. If requested by the Chief Procurement Officer, a three (3) foot sample of the cable intended to be provided under this specification, shall be submitted within fifteen (15) business days after receipt of the request.
- (d) Warranty. The manufacturer shall warrant the cable to be first class material throughout. The manufacturer will be responsible for any cable failing during normal use within one (1) year after the date of installation. The manufacturer will be responsible for providing the footage of cable necessary to replace the failed cable length(without splices).

CABLE

3. (a) The cable must meet the requirements of ICEA Specification S-76-474 for neutral supported power cable assemblies rated for 600 Volts. Each insulated conductor must be listed with UL as Type RHW-2 or Type USE-2, and must meet the NEC's requirements for these types of cable up to 90° Centigrade in wet or dry

Infrastructure Stabilization Items Scopes of Work and Specifications

conditions.

- (b) Messenger. The messenger must be bare steel reinforced aluminum wire (ACSR) meeting the requirements of ASTM B232.
- (c) Covered Conductors. The covered conductors must be made of compressed stranded aluminum meeting the requirements of ASTM B231.
- (d) Lay. The lay of the stranded conductors must meet the requirements of ASTM
- (e) Joints. No welds are permitted in the messenger. The stranded conductors may be welded, but a welding in one strand shall be at least fifty feet (50') from any other weld in the same wire or any other wire in the conductor.

Separator. A separator of mylar tape under the insulation, or other equivalent material, shall be provided. The conductor covering shall be of such consistency that linemen will be able to cut and strip the covering with normally used line tools. Any conductor received which does not meet the cutting and stripping requirements will be returned at the supplier's expense.

(f) Insulation. The insulation must be black cross linked polyethylene in accordance with the physical and

(1) insulation. The insulation must be black cross-linked polyethylene in accordance with the physical and electrical requirements detailed herein, and determined by the test procedures of ASTM D-470, except as otherwise specified. The outside diameter of the insulating covering must be circular and extruded concentrically over the conductor. It must have an average thickness as shown in these specifications, and a minimum thickness of not less than 95% of the average.

PHYSICAL AND ELECTRICAL PROPERTIES

4. (a) Physical Properties - Initial Value.

- 1. Tensile Strength 1800 psi min.
- 2. Elongation at Rupture 350% min.

2. (b) Physical Properties - After Aging.

After oven exposure at $121^{\circ} + 1^{\circ}\text{C}$ for 168 hours:

- 1. Tensile strength, min% of imaged value 80
- 2. Elongation, min % of imaged value at rupture 80

Infrastructure Stabilization Items Scopes of Work and Specifications

(c) Moisture Resistance. When tested in accordance with the procedure given in ASTM D-470, except that the water must be maintained at $75^{\circ}\text{C} + 1^{\circ}\text{C}$, the insulation must meet the following moisture resistance requirements:

- 1. Gravimetric Method:
 - Water absorption, maximum (Mg. per sq. in) 5.0
- 2. Electrical Method:
 - Specific inductive capacitance-one day (Max.) 4.0
 - Percent (%) change in SIC:
 - 1 - 14"days (Max.) 3.0 7-14 days (Max.) 2.0
 - Percent (%) change in Power Factor - 1 day (Max.) 1.5
 - Stability Factor (Max.) 1.0

(d) Electrical Characteristics:

1. Dielectric Strength. Each length of insulated conductor must withstand an alternating current potential as shown in table I for an exposure period of five (5) minutes when tested in accordance with ASTM D-470.
2. Insulation Resistance. The insulation resistance of the insulated conductor must not be less than that corresponding to a constant of 25,000 at 15.6°C (60°F).

(e) Cold Bend Test Requirement. The insulated conductor must pass the "Cold-Bend, Long-Time Voltage Test on Short Specimens" of ASTM D-470 except that the test must be at minus 55°C.

CABLE ASSEMBLY

5. (a) Cabling. The insulated conductors must be reverse twisted about the messenger one (1) to one and one quarter (1-1/4) revolutions in each direction so that each conductor occupies all of the positions on the periphery of the circle periodically with an approximate distance between reversals of four feet (4').

Infrastructure Stabilization Items Scopes of Work and Specifications

1

(b) Binding of Cable. The insulated conductors shall be bound to the messenger without fillers. The binder wire or tape shall have sufficient strength to support the assembly, but in no case will it be smaller than a #10 AWG equivalent. The binder shall be flat without sharp edges. Its strength shall be suitable for installation by the use of stringing blocks and must not itself tear, nor cut, or otherwise damage the conductor insulation. The binder wire must be applied with a left hand lay of five and one-half inches (5-1 IT) ± one half inch (112").

SIZE OF SECONDARY CABLE

6. The insulated conductor must be No. 8 AWS - 7 strands. The bare neutral conductor must be No. 8 with 6 strands of aluminum around 1 strand of steel.

TESTING

7. (a) General. Tests shall be performed on insulation and completed cables in accordance with applicable standards as listed in these specifications. Where standards are at variance with each other or with other portions of this specification, the most stringent requirements, as determined by an engineer from the Division of Engineering, shall apply. Included in these tests will be a 70,000 BTU per hour flame test in accordance with IEEE 383.

(b) Number of Tests. Insulation tests shall be conducted on samples taken every 25,000 feet or fraction thereof of each conductor size. In no case will samples be taken closer than 15,000 feet apart.

(c) Test Reports. No cable may be shipped until certified copies of all factory tests have been reviewed and

- (c) TEST REPORTS. NO CABLE may be shipped until certified copies of all factory tests have been reviewed and approved by the engineer.
- (d) Acceptance. Where the cable fails to conform to any of the tests specified herein, the following will apply:
 1. Insulation or Jacket Tests. Samples must be taken from each reel and must successfully conform to all tests specified herein. Reels from which samples fail to conform, will be rejected.
 2. Completed Cable (Reel) Tests. Any reel which fails to conform to testing will be rejected.

Infrastructure Stabilization Items Scopes of Work and Specifications

PACKING AND SHIPPING

8. (a) Reels. The cables must be shipped in 1000 foot lengths on non-returnable reels which shall be capable of withstanding, without damage, shipping, outside storage and handling during installation. "City of Chicago" shall be clearly printed on one (1) outside reel flange, and the insulated conductors on the beginning end shall not protrude beyond the reel flange. The bare neutral shall be securely stapled on the outside of the flange. The dimension of the reel flange must not be larger than thirty-eight inches (38") in diameter, the drum sixteen inches (16"0) in diameter, and eighteen inches (18") inside traverse. If reels are to be shipped on flange side, they must have two inch (2") spacers separating them for accessibility to fork lift trucks.
- (b) Length. The cable must be shipped in lengths shown above with a zero plus (+) tolerance and a ten percent (10%) minus (-) tolerance. Lengths shorter than minus ten percent (-10%) must not be shipped as they will not be accepted.

IDENTIFICATION

9. (a) Cable Identification. The cable must be identified by a permanently inscribed legend on each insulated conductor in white lettering. The legend must have the following information at a minimum: conductor size(AWG), 600V, XLPE, 90°, RHW-2 or USE-2, manufacturer's name, date of manufacturer, and phase number. All markings must be a minimum of one-eighth inch (1/8") in height. Marking shall be at approximately two (2) foot intervals.
- (b) Reel Marking. Each reel must be tagged on both the inside and outside of one-reel flange with the following information which must be indelibly imprinted on a 2" x 4" brass tag: Purchaser's name and address, wire description, Purchase, or Contract, order number, size designation, net length, manufacturer's name, date of manufacture and gross weight.

Infrastructure Stabilization Items Scopes of Work and Specifications

ELECTRICAL SPECIFICATION 1462

**DIVISION OF ENGINEERING DEPARTMENT OF
TRANSPORTATION CITY OF CHICAGO REVISED NOVEMBER 21,
2014**

RIGID STEEL CONDUIT (HOT DIPPED GALVANIZED)

SCOPE

1. This specification describes rigid steel conduit, zinc coated. This specification also describes rigid steel conduit that is both zinc and PVC coated. The conduit will be used underground or on structure as a raceway for electrical cables.

GENERAL REQUIREMENTS

2. (a) Rigid steel conduit must be zinc coated by the hot-dip process. Conduit must be furnished in 10 foot lengths, threaded on each end and with one coupling attached to one end and a protective cap at the other end.

(b) The conduit shall be manufactured according to Underwriters Laboratories Standard U.L. - 6 and must meet ANSI Standard C 80.1 and the requirements of NEC Article 344. In addition, conduit must be recognized as an equipment grounding conductor as per NEC Article 250. There will be no exceptions to meeting these standards.

(c) Acceptance. Conduit not conforming to this specification will be rejected. The Commissioner will be the final judge in determining if the conduit meets the specification.

(d) Sample. If requested by the Chief Procurement Officer, a sample of conduit must be submitted to the Engineer of Electricity within fifteen (15) business days of receipt of such a request.

(e) Warranty. The manufacturer shall warrant the construction and performance of the conduit to meet the requirements of this specification and shall warrant all parts and components against defects due to design,

workmanship, or material developing within a period of one (1) year after the conduit has been delivered.

Conduit shall be formed from steel suitable for use as an electrical raceway. It shall be structurally sound so that it will hang straight and true when supported by hangers in accordance with Chicago electrical code requirements and shall be capable of being field bent without deformation of the walls.

Conduit shall have a circular cross section sufficiently accurate to permit the cutting of threads in accordance with Table 2 and shall provide a uniform wall thickness throughout. All surfaces shall be smooth and free of injurious defects. The dimensions and weights of rigid steel conduit must be in accordance with Table 1.

THREADING AND CHAMFERING

4. Each length of conduit, and each nipple, elbow and bend must be threaded on both ends, and each end must be chamfered to remove burrs and sharp edges.

The number of threads per inch, and the length of the threaded portion at each end of each length of conduit, nipple and elbow must be as indicated in Table 2. The perfect thread must be tapered for its entire length, and the taper must be 3/4 inch per foot.

ZINC COATING

5. After all cutting, threading, and chamfering all conduit surfaces shall be thoroughly cleaned before application of zinc. The cleaning process shall leave the interior and exterior surfaces of the conduit in such a condition that the zinc will be firmly adherent and smooth.

The conduit must be hot dipped galvanized both inside and out to provide approximately two (2) ounces of zinc per square foot. This is equivalent to 3.4 mils of zinc coating. An additional interior coating to aid in the installation of wires is required.

COUPLINGS

6. (a) The outside surface of couplings shall be protected by means of a zinc coating. The zinc content of the coating on the outside surface must be equivalent to a minimum thickness of 3.4 mils.

- (b) Couplings shall be so made that all threads will be covered when the coupling is pulled tight on standard conduit threads.
- (c) Both ends of the coupling must be chamfered to prevent damage to the starting threads.
- (d) The outside diameter, length and weight of coupling must be as indicated in Table 3.
- (e) Couplings must be straight tapped, except that the 2 1/2 inch and larger sizes may be taper-tapped.

PVC COATED (WHEN SPECIFIED)

PVC COATED (WHEN SPECIFIED)

- (a) Only hot dipped galvanized conduit, couplings, and fittings may be polyvinylchloride (PVC) coated.
- (b) All conduit, couplings, and fittings must be cleaned before being coated.
- (c) All conduit, couplings, and fittings must have a PVC coating applied to the exterior by dipping in liquid plastisol. The coating thickness must be a nominal 40 mils.
- (d) All coated conduit, couplings, and fittings must conform to the requirements of NEMA Standard RN1- Section 3 , "External Coatings". The latest revision will apply.

PACKING AND IDENTIFICATION

8. The pipe shall be delivered in bundles. Each length of conduit must be marked with the manufacturer's name or trademark. Securely attached to each bundle at two (2) locations on the bundle must be a weather resistant tag containing the following information:
- a. conduit size
 - b. footage of bundle
 - c. gross weight of bundle
 - d. manufacturer's name

Precaution will be taken by the contractor in handling during shipment or delivery of conduit, and any conduit found to be damaged will not be accepted.

TEST AND INSPECTION

Infrastructure Stabilization Items Scopes of Work and Specifications

9. Galvanized rigid conduit must be capable of being bent cold into a quarter of a circle around a mandrel, the radius of which is four times the nominal size of the conduit, without developing cracks at any portion and without opening the weld.

The protective coatings used on the outside and inside surfaces of rigid steel conduit must be sufficiently elastic to prevent their cracking or flaking off when a finished sample of 2 inch conduit is tested within one year after the time of manufacture, by bending it into a half of a circle around a mandrel, the radius of which is 3 1/2 inches.

Tests on sizes other than 1/2 inch may be conducted within one year after the time of manufacture. If such tests are conducted, the conduit must be bent into a quarter of a circle around a mandrel, the radius of which is six times the nominal size of the conduit.

One of the following three test methods shall be employed for measuring the thickness or extent of the external zinc coating on conduit:

- (a) Magnetic test.
- (b) Dropping test.
- (c) Preece test (Material which will withstand four 1-minute immersions will be considered as meeting requirements as follows: the zinc content of the coating on the outside surface must be

meeting requirements as follows, the zinc content of the coating on the outside surface must be equivalent to a minimum thickness of 3.4 mils).

All tests and inspections must be made at the place of manufacture prior to shipment unless otherwise specified, and shall be so conducted as not to interfere with normal manufacturing processes.

Each length of conduit shall be examined visually both on the outside and inside to determine if the product is free from slivers, burrs, scale or other similar injurious defects (or a combination thereof), and if coverage of the coating is complete.

If any samples of rigid steel conduit tested as prescribed in this specification should fail, two additional samples must be tested, both of which must comply with the requirements of the specification.

All pipe which may develop any defect under tests, or which may before testing or on delivery be found defective, or not in accordance with these specifications, must be removed by the Contractor at his own expense; and such pipe so removed by the Contractor must be replaced by him within ten (10) days of such rejection with other pipe which will conform to these specifications.

Infrastructure Stabilization Items Scopes of Work and Specifications

TABLE 1

Design Dimension and Weights of Rigid Steel Conduit

Nominal or Trade Size of Conduit	Inside Diameter	Outside Diameter
(Inches)	(Inches)	(Inches)
1/2	0.622	0.840
3/4	0.824	1.050
1	1.049	1.315
1 1/4	1.380	1.660
1 1/2	1.610	1.900
2	2.067	2.375
2 1/2	2.469	2.875
3	3.068	3.500
3 1/2	3.548	4.000
4	4.026	4.500
Wall Thickness	Length Min. Without Weight Coupling	of Ten Unit Length w/cou plings
(Inches)	(Feet/Inches) (lbs]	
0.100	0 11 1/4	70.00

0.109	9-11 1/4	19.00
0.113	9-11 1/4	105.0
0.133	9-11	153.0
0.140	9-11	201.0
0.145	9-11	249.0
0.154	9-11	334.0
0.203	9-10 1/2	527.0
0.216	9-10 1/2	690.0
0.226	9-10 1/4	831.0
0.237	9-10 1/4	982.0

NOTE: The applicable tolerances are:

Length: + 1/4 inch (without coupling)

Outside diameter: + 1/64 inch or -1/32 inch for the 1 1/2 inch and smaller sizes,
± 1 % for the 2 inch and larger sizes.

Wall thickness: -12 1/2%

Infrastructure Stabilization Items Scopes of Work and Specifications

TABLE 2

Dimensions of Threads

Nominal or
Trade Size of Conduit (Inches)
Threads
per
Inch
Pitch Diameter at end of Thread (Inches) Tapered 3/4 Inch per foot
Overall L4
Length of Thread (Inches)

Effective L2

1/2 3/4 1
 1 1/4
 1 1/2 2
 2 1/2 3
 3 1/2 4
 14 14
 11 1/2 11 1/2 11 1/2 11 1/2 8 8 8 8
 0.7584 0.9677 1.2136 1.5571 1.7961 2.2690 2.7195 3.3406 3.8375 4.3344
 0.53 0.55 0.68 0.71 0.72 0.76 1.14 1.20 1.25 1.30
 0.78 0.79 0.98 1.01 1.03 1.06 1.57 1.63 1.68 1.73

NOTE: The applicable tolerances are:

Threaded Length (L4Col5): Plus or minus one thread

Pitch Diameter (Col 3): Plus or minus one turn is the maximum variation permitted from the gaging face of the working thread gages. This is equivalent to plus or minus one and one half turns from basic dimensions, since a variation of plus or minus one half turn from basic dimensions is permitted in working gages.

Infrastructure Stabilization Items Scopes of Work and Specifications

TABLE 3

Designed Dimensions and Weights of Couplings

Nominal or Trade Size of Conduit (INCHES)	Outside Diameter (INCHES)	Minimum Length (INCHES)	Minimum Weight (POUNDS)
1/2	1.010	1-9/16	0.115
3/4	1.250	1-5/8	0.170
1	1.525	2	0.300
1 1/4	1.869	2-1/16	0.370
1 1/2	2.155	2-1/16	0.515
2	2.650	2 1/8	0.671
3 1/2	3.250	3-1/8	1.675
3	3.870	3-1/4	2.085
4 1/2	4.500	3-3/8	2.400
4	4.875	3-1/2	2.839

Infrastructure Stabilization Items Scopes of Work and Specifications

EXHIBIT 11: MAP OF SOCIOECONOMICALLY DISADVANTAGED AREAS

See following page.

Map of Socioeconomically Disadvantaged Areas

Map of Socioeconomically Disadvantaged Areas

EXHIBIT 12: AFFIDAVIT REGARDING IDENTIFICATION OF ALL WASTE AND MATERIAL HANDLING AND DISPOSAL FACILITIES

Contractor to show here the name and location of the waste and material recovery facilities he/she is proposing to use for the Project. Complete one page per facility:

SPECIFY THE TYPE OF MATERIALS TO BE DISPOSED OF:

Light Bulb

LEGAL NAME OF WASTE AND MATERIAL RECOVERY FACILITY:

Fluorecvcle

(The Contractor will provide to the City copies of all dump tickets, manifests, etc.)

LOCATION ADDRESS: 27780 W Concrete Dr. Unit A

Ingleside. IL 60041

PHONE: (815) 363-4411 CONTACT PERSON: Lenny Worth

If requested by the Chief Procurement Officer, the Contractor must submit copies of all contractual agreements, permits and/or licenses for those waste and material recovery facilities proposed by the Contractor.

Affidavit Regarding Identification of all Waste and Material Handling and Disposal Facilities

Contractor to show here the name and location of the waste and material recovery facilities he/she is proposing to use for the Project. Complete one page per facility:

SPECIFY THE TYPE OF MATERIALS TO BE DISPOSED OF:

Plastic, Glass, Insulation, Misc.

LEGAL NAME OF WASTE AND MATERIAL RECOVERY FACILITY:

Lakeshore Recycling Systems

(The Contractor will provide to the City copies of all dump tickets, manifests, etc.)

LOCATION ADDRESS: 3152 S California Ave. Chicago IL 60608 PHONE: (773) 579-1999

CONTACT PERSON: Calvin King

If requested by the Chief Procurement Officer, the Contractor must submit copies of all contractual agreements, permits and/or licenses for those waste and material recovery facilities proposed by the Contractor.

Affidavit Regarding Identification of all Waste and Material Handling and Disposal Facilities

Contractor to show here the name and location of the waste and material recovery facilities he/she is proposing to use for the Project. Complete one page per facility:

SPECIFY THE TYPE OF MATERIALS TO BE DISPOSED OF:

Aluminum, Copper, Steel

LEGAL NAME OF WASTE AND MATERIAL RECOVERY FACILITY:

Scrap Metal Services

(The Contractor will provide to the City copies of all dump tickets, manifests, etc.)

LOCATION ADDRESS: 13830 Brainard Ave. Burnham. IL 60633

PHONE: (708) 730-1400

CONTACT PERSON: Ken Rutkowski

If requested by the Chief Procurement Officer, the Contractor must submit copies of all contractual agreements, permits and/or licenses for those waste and material recovery facilities proposed by the Contractor.

EXHIBIT 13: CONTRACTOR'S COMMITMENT TO MINORITY AND FEMALE EMPLOYEE UTILIZATION GOALS

In accordance with Chapter 2-92 of the Municipal Code of Chicago, and in order to promote equality of opportunity for minority and female personnel on this project, Contractor has proposed the following minority and female employee utilization goals for the project, as percentages of the journeyworker and apprentice and laborer hours to be expended in the construction of the project.

Actual amounts of minority and female work will be measured for the total hours of construction workers employed on the projects within each of the categories of journeyworkers, apprentice, laborers by the contractor and all of the worksite subcontractors.

This commitment will apply only to the LED conversion and infrastructure stabilization work. Contractor must fill out the following chart to indicate its utilization goals with respect to the LED conversion and infrastructure stabilization portions of this Project.

Line 1	Percentage of the total Journeyworker hours that the Contractor proposes to be worked by minority Journeyworkers during construction of the Project.	25%
Line 2	Percentage of the total Apprentice hours that the Contractor proposes to be worked by minority Apprentices during construction of the project.	25%
Line 3	Percentage of the total Laborer hours that the Contractor proposes to be worked by minority Laborers during construction of the project.	40%
Line 4	Percentage of the total Journeyworker hours that the Contractor proposes to be worked by female Journeyworkers during construction of the project.	7%
Line 5	Percentage of the total Apprentice hours that the Contractor proposes to be worked by female Apprentices during construction of the project.	7%
Line 6	Percentage of the total Laborer hours that the Contractor proposes to be worked by female Laborers during construction of the project.	10%

The Contractor is obligated to meet the total commitment made in each category, subject to liquidated damages as described below for noncompliance. The Contractor hereby consents and agrees that, in the event of failure to comply with each of the minimum commitments on Lines I through 6 above, covering Journeyworkers, Apprentices, and Laborers, respectively, the following shall apply to determine a monetary sum to be withheld from the final payment to the Contractor.

Contractor's Commitment to Minority and Female Employee Utilization Goals

In calculating the aggregated work hours toward the utilization goal for construction Journeyworkers, Apprentices, or Laborers under this chart, the Contractor shall be given 150% credit for every work hour performed by a minority or woman worker residing within a socio-economically disadvantaged area. The criteria for designation of an area as socio-economically disadvantaged, which include but are not limited the median family income of an area, is set forth in rules promulgated by the Commissioner of Planning and Development. Areas designated as socio-economically disadvantaged at the time of this procurement are shown on the map attached in Exhibit 11 of this Contract.

Liquidated Damages

Liquidated damages will be assessed based on the Contractor's failure to meet its utilization goals for the LED conversion and infrastructure stabilization portion of this Project. Utilization goals will be calculated on a Project Phase by Project Phase basis. The value of the LED conversion and infrastructure stabilization work to which this commitment will apply is the total

amount spent on LED conversion and infrastructure stabilization in each given Project Phase ("Phase Value").

For each one percent (1%) deficiency of minority journeyworkers not utilized toward the goal (Line 1), four cents for each hundred dollars of the Phase Value, calculated as follows:

$$\text{Phase Value} \times .04 \\ 100$$

Each one percent (1%) deficiency of shortfall toward the goal line (Line 4) for female Journeyworkers shall be computed in the same way.

For each one percent (1%) deficiency of minority Apprentices not utilized toward the goal (Line 2), three cents per each hundred dollars of the Phase Value, calculated as follows:

$$\text{Phase Value} \times .03 \\ 100$$

Each one percent (1%) of shortfall toward the goal (Line 5) for female Apprentices shall be computed in the same way.

For each one percent (1%) deficiency of minority Laborers not utilized towards the goal (Line 3), one cent per each hundred dollars of the Phase Value, calculated as follows:

$$\text{Phase Value} \times .01 \\ 100$$

Each one percent shortfall toward the goal (Line 6) for female Laborers shall be computed in the same way.

Contractor's Commitment to Minority and Female Employee Utilization Goals

EXHIBIT 14: CONTRACTOR'S CERTIFICATION REGARDING HAZARDOUS WASTE

Contractor's Certification: Hazardous Waste

CONTRACTOR NAME:

PROJECT NUMBER:

CONTRACT NUMBER:

PROJECT DESCRIPTION:

PAY ESTIMATE NUMBER:

I hereby attest that I have reviewed all relevant records and conducted any investigation necessary to confirm and certify that the following is true and correct:

Scope: This certification concerns "Hazardous Waste," as that term is defined in Section 11-4-120 of the Chicago Municipal Code.

I recognize that Contractor and all subcontractors are required to manage Hazardous Waste in accordance with the terms of the above-identified Contract; that this certification does not create options beyond what is provided in the Contract; and that by completing this certification, I may be admitting violations of law or of the Contract.

Time Period of this certification: This certification covers the period of time from the Contractor's most

recent pay estimate, from / / (MM/DD/YYYY) to / / .

Check all that apply:

As of the date that I signed this certification, some amount of Hazardous Waste is located on the project site. I have attached to this certification a complete, narrative description of the volume, weight, and types of this Hazardous Waste and how, by whom, and where on the project site it is being managed.

During the Time Period of this certification, no Hazardous Waste was transported from the project site.

During the Time Period of this certification, Hazardous Waste was transported from the project site, and 100% of that Hazardous Waste was deposited at a facility named on Contractor's Affidavit Regarding Identification of All Waste and Material Handling and Disposal Facilities ("Affidavit") to the above-identified Contract.

During the Time Period of this certification, Hazardous Waste was transported from the project site; less than 100% of that Hazardous Waste was deposited at a facility named on Affidavit to the above-identified Contract; and

C All of the transported Hazardous Waste that was not deposited at a facility named on Affidavit to the above-identified Contract was deposited at the facility/facilities listed below; I have attached copies of all manifests corresponding to this Hazardous Waste, and I have attached copies of all current Hazardous-Waste-related permits for each facility listed below; or

Contractor's Certification: Hazardous Waste

Other. I have attached to this certification a complete, narrative description of the volume, weight, and types of the transported Hazardous Waste, its current location(s), all intermediate locations, the identities of all transporters and other handlers of the Hazardous Waste, and copies of any and all documentation that exists that pertains to the handling and handler(s) of this Hazardous Waste, including but not limited to all licenses and permits.

Name of facility:
Address of facility:
Owner and operator of facility:
Contact information for owner and operator of facility:

Name of facility:
Address of facility:
Owner and operator of facility:
Contact information for owner and operator of facility:

CONTRACTOR SIGNATURE:

PRINTED NAME:

TITLE: DATE:

Contractor's Certification: Hazardous Waste

EXHIBIT 15: LED LUMINAIRE SPECIFICATIONS SUBMITTAL FORM

Lighting Context

*SRF, r, ^, ■■■':
-^^^aduct1nformation ■■■■■
t. Area Application*

e.g. Alleys

Product Data "■■■vw- ■■■ (Summary) .,■
■■ 30*

*Submittal.Re
fere nee*

•■mm"scupuon.

Document



Luminaire Designation
Luminaire Manufacturer
Luminaire Model Number
Luminous Flux - initial lumens
Luminaire input power-initial watts
Luminaire input power-maintained watts
Luminaire input voltage-nominal volts
range
LED lumens output - initial

LED drive current - initial	milliamps	
LED drive current -maintained	milliamps	
CCT (correlated color temperature)	kelvin	
CRI (color rendering index)		
EPA (effective projected area) - nominal	sq. ft.	
Luminaire Weight - nominal	lbs.	
Control Interface	<input type="checkbox"/> ANSI C136.41, 7-pin	
LED Driver - dimming capability	<input type="checkbox"/> Dimmable, 0-10V <input type="checkbox"/> Dimmable, DALI	
LED driver- rated life	years	
Electrical transient immunity ANSI C136.2 combination wave test level	<input type="checkbox"/> Basic (6kV/3kA) <input type="checkbox"/> Enhanced (10kV/5kA) <input type="checkbox"/> Elevated (20kV/10kA)	
Vibration Test-ANSI C136.31	<input type="checkbox"/> Level 2	
Luminaire warranty period	years	
IES LM-80 test duration	hours	IES LM-80-15 report
LED lumen maintenance at 36,000 hours	/o	TM-21 calculator
Max. LED case temperature	degrees Celsius	ISTMT report

LED Luminaire Specifications Submittal Form
EXHIBIT 16: LED CONVERSION PRICING SUBMITTAL

Residential Legacy (66 Foot ROW, One-Sided Light Pole Configuration)
 Anticipated 8 of Fixtures - *Default Lumiance.Capacity*

Phase 16,000 -"- Project Total *Boosted Lumiance.Capacity,...*
 64,000 -"

Alley
 in:el1 l_vf-A.N.vfr *Default Lumiance Capacity r "*
 ■
 Anticipated 1f of Fixtures

Phase 16,000 Project Total 64,000 . *Boosted lumiance Capacity*

Arterial (Feeder) Legacy (66 Foot ROW, One-Sided Light Pole Configuration)
 i>:'.:-tl.-.k<-:nwl; *Default Lumiance Capacity*
 Anticipated fl of Futures

Phase 11,000 * - . ■ -"- Project Total *Boosted Lumiance.Capacity*
 44,000 *

Residential Modern (66 Foot ROW, Staggered Light Pole Configuration)
 Anticipated H of Fixtures *Default Lumiance Capacity*

Phase 5,000 Project Total 20,000 *Boosted Lumiance Capacity .*

Arterial (Large) (100 Foot ROW, Opposite Light Pole Configuration) .
 Anticipated fl of Fixtures *Default Lumiance Capacity*

Phase 5,000 Project Total. 20,000 *Boosted Lumiance Capacity*

Vt. ■ \$'
Arterial (Medium) (80 Foot ROW, Staggered Light Pole Configuration) <
 Anticipated * of Fixtures *Default Lumiance. Capacity*
 Phase 4,000 Project Total. 20,000' *Boosted Lumiance Capacity*

Residential Intersection (66 Foot ROW; 45 Degree Angle)

Anticipated 1 of Fixture Phase 4,000 Project Total 16,000
Viaduct

<i>FOR CIT WERMLUSEONLY</i>											
TOTAL	PHASE	1	COSTS	DEFAULT	LUMINANCE	CAPACITY	TOTAL	PHASE	1	COSTS	

BOOSTED LUMINANCE CAPACITY

LED Conversion Pricing Submittal